



2024 Product Catalog



Bring something spectacular to the table.

American Metalcraft products elevate food service in every form—restaurants, grocery stores, hotels and catered events alike. To see the difference that incredible presentation can make, look to the little things. Whether we're making barware or buffetware, we find opportunities to incorporate unique details, exceptional functionality and on-trend designs. Our goal is always to make your culinary creations the best possible versions of themselves.

Over seventy-five years ago, we broke into the industry by turning hubcaps into deep-dish pizza pans and custom plate covers. We've since grown our product line into an expansive, eclectic collection of food presentation solutions. In these pages, you'll discover creative tabletop accessories, innovative kitchen supplies and every other tool you need to craft an incredible dining experience. **It all boils down to this: Great food deserves great presentation.**



Dinnerware ⁹⁻⁴⁸

Tabletop Accessories ⁴⁹⁻¹⁶⁶

Buffet & Display ¹⁶⁷⁻³³⁰

Bar Supplies ³³¹⁻³⁷⁶

Kitchen Supplies ³⁷⁷⁻³⁹⁸

Pizza Pans & Supplies ³⁹⁹⁻⁴⁵³

Symbols



Products that are new to our catalog in 2024.



Products that are among our best sellers.



Products that are available in retail packaging or with a retail hang tag.



Products that should be hand washed only.



Products that are economically shipped knocked down. May require assembly.



Products that have received NSF certification and meet strict standards for public health protection.



Products manufactured in the United States of America.



Products that do not contain Bisphenol-A.



WARNING: Products that may contain chemicals known to the state of California to cause cancer, birth defects or other reproductive harm. For more information, go to www.P65Warnings.ca.gov.

Great food deserves great presentation.

Check out some of our new product highlights.



36
Ani Collection

An incredibly sleek and affordable dinnerware line.

225

Lift Collection Tiered Stands



Take presentation to new heights with these adjustable stands. Customize for a one-tier, two-tier or three-tier stand. Features plates with a reversible design.

192

Amano Buffetware



Each piece is hand forged of durable stainless steel for a unique and sophisticated look.

145

Marble Bud Vases



These simple yet elegant bud vases are designed to make flowers pop.

BUILDING BLOCKS



284

Black Twilight Collection Modular Risers



186

Acacia Wood Juice Dispenser Base



Building a customized buffet display has never been easier with our **Black Twilight Collection Modular Risers**. Designed to adapt to changing menu needs, each riser can expand a display taller, wider or longer to serve anything from a small luncheon to a large dinner party. Further personalize the look with complementary platters available in different lengths and finishes.



257

Acacia Wood Serving Platters



234

White Marble Melamine Serving Platters



186

Upton Collection Juice Dispenser Base



Give a beverage station an instant upgrade with this beautiful wood base.

250

Upton Collection Plates



Espresso-finished wood plates feature a rimmed design to frame any menu option.

251

Upton Collection Platters



These stately espresso-finished wood platters pair perfectly with the Black Twilight Modular Risers.



THE UNITY COLLECTION

Finally, a contemporary take on melamine dinnerware that provides the ultimate canvas for today's modern cuisine: the Unity Collection. Named for the intersection of form and function, the Unity Collection combines a clean, straight-sided and stackable design with the durability of melamine. The result is delectably inspiring.

Available in a wide variety of shapes, sizes, and capacities, this dual-toned collection features colorways to approach both the coolest and warmest of decors. Intermix the graphite and mocha colors together, add a splash of stainless and a touch of Tritan™ and your recipe is complete. The look is truly extraordinary.



THE UNITY COLLECTION



Graphite
(GE)



Mocha
(MO)

Please add **GE** for Graphite or **MO** for Mocha to the end of the item number to designate color choice when ordering.



Square Plate
UPS11GE Graphite
UPS11MO Mocha
 11" Sq. x ½" H (27.9 x 1.3 cm)



Square Plate
UPS9GE Graphite
UPS9MO Mocha
 9" Sq. x ½" H (22.9 x 1.3 cm)



Square Plate
UPS6GE Graphite
UPS6MO Mocha
 6" Sq. x ½" H (15.2 x 1.3 cm)



Rectangular Serving Platter
UPLS10GE Graphite
UPLS10MO Mocha
 10" L x 4 ¾" W x ⅞" H (25.4 x 12.1 x 2.2 cm)



Square Serving Bowl/Tray
UBS60GE Graphite
UBS60MO Mocha
 60 oz. (1.8 L)
 10" Sq. x 1 ½" H (25.4 x 3.8 cm)



Square Bowl
UBS16GE Graphite
UBS16MO Mocha
 16 oz. (473.2 mL)
 4 ½" Sq. x 2" H (11.4 x 5.1 cm)



Square Bowl
UBS10GE Graphite
UBS10MO Mocha
 10 oz. (295.7 mL)
 3 ⅝" Sq. x 2" H (9.2 x 5.1 cm)



Square Sauce Cup
USCS2GE Graphite
USCS2MO Mocha
 2 oz. (59.1 mL)
 2" Sq. x 1 ⅝" H (5.1 x 4.1 cm)



Stackable Mug
UM12GE Graphite
UM12MO Mocha
 12 oz. (354.9 mL)
 3 ⅞" Dia. x 4 ⅛" H (7.9 x 10.5 cm)



Round Plate
UPR11GE Graphite
UPR11MO Mocha
 11" Dia. x 1/2" H (27.9 x 1.3 cm)



Round Plate
UBR9GE Graphite
UBR9MO Mocha
 9" Dia. x 1/2" H (22.9 x 1.3 cm)



Round Plate
UPR6GE Graphite
UPR6MO Mocha
 6" Dia. x 1/2" H (15.2 x 1.3 cm)



Oval Serving Platter
UPLR10GE Graphite
UPLR10MO Mocha
 10 1/2" L x 5 1/4" W x 7/8" H (26.7 x 13.3 x 2.2 cm)



Round Serving Bowl/Tray
UBR48GE Graphite
UBR48MO Mocha
 48 oz. (1.4 L)
 10" Dia. x 1 1/2" H (25.4 x 3.8 cm)



Round Bowl
UBR32GE Graphite
UBR32MO Mocha
 32 oz. (946.4 mL)
 6 1/4" Dia. x 2 1/2" H (15.9 x 6.4 cm)



Round Bowl
UBR24GE Graphite
UBR24MO Mocha
 24 oz. (709.8 mL)
 5 3/4" Dia. x 2 1/4" H (14.6 x 5.7 cm)



Tapered Bowl
UBRT24GE Graphite
UBRT24MO Mocha
 24 oz. (709.8 mL)
 5 5/8" Dia. x 2 5/8" H (14.3 x 6.7 cm)



Round Bowl
UBR16GE Graphite
UBR16MO Mocha
 16 oz. (473.2 mL)
 5 1/8" Dia. x 2" H (13 x 5.1 cm)



Tapered Bowl
UBRT16GE Graphite
UBRT16MO Mocha
 16 oz. (473.2 mL)
 5" Dia. x 2 3/8" H (12.7 x 6 cm)



Round Bowl
UBR10GE Graphite
UBR10MO Mocha
 10 oz. (295.7 mL)
 4 1/4" Dia. x 2" H (10.8 x 5.1 cm)



Tapered Bowl
UBRT10GE Graphite
UBRT10MO Mocha
 10 oz. (295.7 mL)
 4 3/8" Dia. x 2" H (11.1 x 5.1 cm)



Round Bowl
UBR5GE Graphite
UBR5MO Mocha
 5 oz. (147.9 mL)
 3 5/8" Dia. x 1 5/8" H (9.2 x 4.1 cm)



Round Sauce Cup
USCR2GE Graphite
USCR2MO Mocha
 2 oz. (59.1 mL)
 2 1/2" Dia. x 1 5/8" H (6.4 x 4.1 cm)



SMP4

SMP6

SMB3

Top to bottom:
SMP9
SMP11



Top to bottom:
SMP4
SMP6
SMP9
SMP11

THE UNITY COLLECTION

Who says that flatware should be the only touch of silver at a place setting? The Unity Collection's satin-finished stainless steel plates and bowls not only bring together form and function at the table, but they unite different materials in a beautiful marriage of modern sophistication. Use as the star of the show or as a beautiful accessory; each piece is beautifully designed to add a bit of sparkle to your meal.



Plate
SMP11 Satin Finish
 11" Dia. x 1/2" H (27.9 x 1.3 cm)



Plate
SMP9 Satin Finish
 9" Dia. x 1/2" H (22.9 x 1.3 cm)



Plate
SMP6 Satin Finish
 6" Dia. x 1/2" H (15.2 x 1.3 cm)



Plate
SMP4 Satin Finish
 4" Dia. x 1/2" H (10.2 x 1.3 cm)



Bowl/Tray
SMB10 Satin Finish
 60 oz. (1.8 L)
 10" Dia. x 1 1/2" H (25.4 x 3.8 cm)



Bowl
SMB6 Satin Finish
 29 oz. (857.6 mL)
 6" Dia. x 2" H (15.2 x 5.1 cm)



Bowl
SMB5 Satin Finish
 15 oz. (443.6 mL)
 5" Dia. x 1 1/4" H (12.7 x 3.2 cm)



Bowl
SMB4 Satin Finish
 8 oz. (236.6 mL)
 4" Dia. x 1 1/4" H (10.2 x 3.2 cm)



Bowl
SMB3 Satin Finish
 4 oz. (118.3 mL)
 3" Dia. x 1" H (7.6 x 2.5 cm)



THE MIX & MATTE COLLECTION



White
(WH)



Marble
(MA)



Gray
(GR)



Gray Marble
(GM)

When laid-back presentation won't cut it, our Mix & Matte Collection of melamine dinnerware lends an air of luxury. Designed to be mixed and matched, these matte pieces can stand up to even the noblest menu items.

Please add WH for White, MA for Marble, GR for Gray or GM for Gray Marble to the end of the item number to designate color choice when ordering.



Coupe Plate

MCP11WH White MCP11MA Marble
MCP11GR Gray MCP11GM Gray Marble
11 ½" Dia. x 1" H (29.2 x 2.5 cm)



Coupe Plate

MCP9WH White MCP9MA Marble
MCP9GR Gray MCP9GM Gray Marble
9" Dia. x 1" H (22.9 x 2.5 cm)



Coupe Plate

MCP6WH White MCP6MA Marble
MCP6GR Gray MCP6GM Gray Marble
6" Dia. x 5/8" H (15.2 x 1.6 cm)



Rectangular Platter

MCP12WH White MCP12MA Marble
MCP12GR Gray MCP12GM Gray Marble
12" L x 7" W x 1" H (30.5 x 17.8 x 2.5 cm)



Coupe Bowl

MCB36WH White MCB36MA Marble
MCB36GR Gray MCB36GM Gray Marble
36 oz. (1.1 L)
8 ¾" Dia. x 2" H (22.2 x 5.1 cm)



Coupe Bowl

MCB24WH White MCB24MA Marble
MCB24GR Gray MCB24GM Gray Marble
24 oz. (709.8 mL)
7 ½" Dia. x 1 ¾" H (19 x 4.4 cm)



Coupe Bowl

MCB16WH White MCB16MA Marble
MCB16GR Gray MCB16GM Gray Marble
16 oz. (473.2 mL)
6 ½" Dia. x 1 ½" H (16.5 x 3.8 cm)



Coupe Bowl

MCB12WH White MCB12MA Marble
MCB12GR Gray MCB12GM Gray Marble
12 oz. (354.9 mL)
6" Dia. x 1 ½" H (15.2 x 3.8 cm)



Bouillon Cup

MCB10WH White MCB10MA Marble
MCB10GR Gray MCB10GM Gray Marble
10 oz. (295.7 mL)
4 ½" Dia. x 2 ¼" H (11.4 x 5.7 cm)



Mug

MM12WH White
12 oz. (354.9 mL)
3 ⅞" Dia. x 4 ⅛" H (7.9 x 10.5 cm)



THE COUPE COLLECTION

Elegant yet simple, the Coupe Collection offers a level of subtle refinement to the tabletop. Available in a wide array of popular sizes, this satin-finished line of stainless steel dinnerware is a versatile (yet durable) suggestion in modern dinnerware. Use as a charger, a dinner plate, a tray, a coaster - the options are endless.



Coupe Plate
SSP16 Satin Finish
 16" Dia. x $\frac{3}{8}$ " H (40.6 x 1 cm)



Coupe Plate
SSP15 Satin Finish
 15" Dia. x $\frac{3}{8}$ " H (38.1 x 1 cm)



Coupe Plate
SSP14 Satin Finish
 14" Dia. x $\frac{3}{8}$ " H (35.6 x 1 cm)



Coupe Plate
SSP13 Satin Finish
 13" Dia. x $\frac{3}{8}$ " H (33 x 1 cm)



Coupe Plate
SSP12 Satin Finish
 12" Dia. x $\frac{3}{8}$ " H (30.5 x 1 cm)



Coupe Plate
SSP10 Satin Finish
 10 $\frac{1}{2}$ " Dia. x $\frac{3}{8}$ " H (26.7 x 1 cm)



Coupe Plate
SSP9 Satin Finish
 9" Dia. x $\frac{3}{8}$ " H (22.9 x 1 cm)



Coupe Plate
SSP8 Satin Finish
 8" Dia. x $\frac{3}{8}$ " H (20.3 x 1 cm)



Coupe Plate
SSP6 Satin Finish
 6" Dia. x $\frac{3}{8}$ " H (15.2 x 1 cm)



Coupe Plate
SSP4 Satin Finish
 4" Dia. x $\frac{3}{8}$ " H (10.2 x 1 cm)



THE CRAVE COLLECTION

Our Crave Collection of break-resistant melamine dinnerware is back and bigger than ever. In a wide variety of plates, platters, bowls and mugs, this is not your grandma's melamine. Fast forward, rather, to the 21st century, where technological advancements in designs, materials, and manufacturing techniques create artisan-quality melamine that captures the look and feel of china—all at a fraction of the cost and two to three times the service life.

NSF-certified and BPA-free, the Crave Collection is safe in terms of durability, design, and ability to be thoroughly sanitized. In two base colors and new additional color options, each artisanally designed piece features organic edges to elevate foodservice everywhere.

HOT



HOT



Top to bottom:
CBL16CL, CP7SH, CP10CL

THE CRAVE COLLECTION



Please add **CL** for Cloud or **SH** for Shadow to the end of the item number to designate color choice when ordering.



Coupe Plate
CP10CL Cloud **CP10SH** Shadow
 11 1/8" Dia. x 3/4" H (28.3 x 1.9 cm)



Coupe Plate
CP9CL Cloud **CP9SH** Shadow
 9" Dia. x 1" H (22.9 x 2.5 cm)



Coupe Plate
CP7CL Cloud **CP7SH** Shadow
 7 1/2" Dia. x 7/8" H (19.1 x 2.2 cm)



Coupe B&B Plate
CP6CL Cloud **CP6SH** Shadow
 6 1/2" Dia. x 3/4" H (16.5 x 1.9 cm)



Rectangular Platter
CP12CL Cloud **CP12SH** Shadow
 12" L x 7 1/8" W x 1" H (30.5 x 18.1 x 2.5 cm)



Oval Serving Platter
CPL12CL Cloud **CPL12SH** Shadow
 12" L x 9" W x 7/8" H (30.5 x 22.9 x 2.2 cm)



Serving Bowl
CBL95CL Cloud **CBL95SH** Shadow
 95 oz. (2.8 L)
 13 1/2" Dia. x 2 1/4" H (34.3 x 5.7 cm)



Coupe Bowl
CBL20CL Cloud **CBL20SH** Shadow
 20 oz. (591.5 mL)
 9" Dia. x 1 1/2" H (22.9 x 3.8 cm)



Coupe Bowl
CBP16CL Cloud **CBP16SH** Shadow
 16 oz. (473.2 mL)
 8 1/2" Dia. x 1 1/2" H (21.6 x 3.8 cm)



Coupe Bowl
CBL13CL Cloud **CBL13SH** Shadow
 13 oz. (384.5 mL)
 7" Dia. x 1 1/2" H (17.8 x 3.8 cm)



Coupe Bowl
CBL8CL Cloud **CBL8SH** Shadow
 8 oz. (236.6 mL)
 6" Dia. x 1 1/4" H (15.2 x 3.2 cm)



Noodle Bowl
CBL50CL Cloud **CBL50SH** Shadow
 50 oz. (1.5 L)
 7 1/2" Dia. x 4 3/4" H (19.1 x 12.1 cm)



Noodle Bowl
CBL40CL Cloud **CBL40SH** Shadow
 40 oz. (1.2 L)
 7 1/8" Dia. x 4 1/4" H (18.1 x 10.8 cm)



Bowl
CBL32CL Cloud **CBL32SH** Shadow
 32 oz. (946.4 mL)
 7 1/8" Dia. x 2 1/2" H (18.1 x 6.4 cm)



Bowl
CBL24CL Cloud **CBL24SH** Shadow
 24 oz. (709.8 mL)
 6 1/2" Dia. x 2 1/4" H (16.5 x 5.7 cm)



Soup/Salad Bowl
CBL16CL Cloud **CBL16SH** Shadow
 16 oz. (473.2 mL)
 6" Dia. x 2" H (15.2 x 5.1 cm)



Nappy Bowl
CBL12CL Cloud **CBL12SH** Shadow
 12 oz. (354.9 mL)
 5 3/4" Dia. x 1 3/4" H (14.6 x 4.4 cm)



Bouillon Cup
CBC10CL Cloud **CBC10SH** Shadow
 10 oz. (295.7 mL)
 4 1/2" Dia. x 2 1/8" H (11.4 x 5.4 cm)



Bouillon Cup
CBC7CL Cloud **CBC7SH** Shadow
 7 oz. (207 mL)
 4" Dia. x 2" H (10.2 x 5.1 cm)



Fruit Bowl
CBL4CL Cloud **CBL4SH** Shadow
 4 1/2 oz. (133.1 mL)
 4" Dia. x 1 1/2" H (10.2 x 3.8 cm)



Sauce Cup
CSC4CL Cloud **CSC4SH** Shadow
 4 1/2 oz. (133.1 mL)
 3 1/4" Dia. x 2" H (8.3 x 5.1 cm)



Stackable Mug
CM12CL Cloud **CM12SH** Shadow
 12 oz. (354.9 mL)
 3 3/8" Dia. x 3 5/8" H (8.6 x 9.2 cm)



THE CRAVE STORM COLLECTION



Storm
(ST)

Our Crave Collection of break-resistant melamine dinnerware is now available in a bold, coordinating color: Storm. NSF-Certified and BPA-free, this collection is safe in terms of durability, design, and ability to be thoroughly sanitized.

Please add **ST** for Storm to the end of the item number to designate color choice when ordering.



Coupe Plate
CP10ST Storm
11 1/8" Dia. x 3/4" H (28.3 x 1.9 cm)



Coupe Plate
CP9ST Storm
9" Dia. x 1" H (22.9 x 2.5 cm)



Coupe Plate
CP7ST Storm
7 1/2" Dia. x 7/8" H (19.1 x 2.2 cm)



Coupe Plate
CP6ST Storm
6 1/2" Dia. x 3/4" H (16.5 x 1.9 cm)



Rectangular Platter
CPI2ST Storm
12" L x 7 1/8" W x 1" H (30.5 x 18.1 x 2.5 cm)



Bowl
CBL20ST Storm
20 oz. (591.5 mL)
9" Dia. x 1 1/2" H (22.9 x 3.8 cm)



Soup/Salad Bowl
CBL16ST Storm
16 oz. (473.2 mL)
6" Dia. x 2" H (15.2 x 5.1 cm)



Nappy Bowl
CBL12ST Storm
12 oz. (354.9 mL)
6" Dia. x 1 3/4" H (15.2 x 4.4 cm)



Bouillon Cup
CBC10ST Storm
10 oz. (295.7 mL)
4 1/2" Dia. x 2 1/8" H (11.4 x 5.4 cm)



Bouillon Cup
CBC7ST Storm
7 oz. (207 mL)
4" Dia. x 2" H (10.2 x 5.1 cm)



Sauce Cup
CSC4ST Storm
4 1/2 oz. (133.1 mL)
3 1/4" Dia. x 2" H (8.3 x 5.1 cm)



Stackable Mug
CM12ST Storm
12 oz. (354.9 mL)
3 3/8" Dia. x 3 3/8" H (8.6 x 9.2 cm)



THE MARRA COLLECTION

Finally. A beautifully-crafted, globally-inspired, durable dinnerware line made with today's menus in mind. Textured just like handcrafted stoneware, it is hard to tell that these plates, bowls, and pots are actually made of durable and affordable melamine. Featuring key items, sizes and capacities, plus boasting NSF-approval, the Marra Collection is one to celebrate!

NEW



NEW

Top to bottom:
MRP9TC
MRP11TC



THE MARRA COLLECTION



Terra Cotta
(TC)



Cloud
(CL)

Please add **TC** for Terra Cotta or **CL** for Cloud to the end of the item number to designate color choice when ordering.



Plate
MRP11TC Terra Cotta
MRP11CL Cloud
11 1/8" Dia. x 1 1/8" H (28.3 x 2.9 cm)



Plate
MRP9TC Terra Cotta
MRP9CL Cloud
8 3/4" Dia. x 1 1/8" H (22.2 x 2.9 cm)



Plate
MRP7TC Terra Cotta
MRP7CL Cloud
7 1/2" Dia. x 1" H (19.1 x 2.5 cm)



Bowl
MRB22TC Terra Cotta
MRB22CL Cloud
22 oz. (650.6 mL)
6 3/8" Dia. x 2 1/2" H
(16.2 x 6.4 cm)



Bowl
MRB13TC Terra Cotta
MRB13CL Cloud
13 oz. (384.5 mL)
5 1/2" Dia. x 2 1/8" H
(14 x 5.4 cm)



Bowl
MRB10TC Terra Cotta
MRB10CL Cloud
10 oz. (295.7 mL)
4 1/4" Dia. x 2 1/2" H
(10.8 x 6.4 cm)



Bowl
MRB6TC Terra Cotta
MRB6CL Cloud
6 oz. (177.4 mL)
3 5/8" Dia. x 2 1/8" H
(9.2 x 5.4 cm)



Pot
MRPT6TC Terra Cotta
MRPT6CL Cloud
6 oz. (177.4 mL)
3" Dia. x 3 1/8" H (7.6 x 7.9 cm)



Pot
MRPT4TC Terra Cotta
MRPT4CL Cloud
4 oz. (118.3 mL)
2 3/4" Dia. x 2 3/4" H (7 x 7 cm)



Pot
MRPT3TC Terra Cotta
MRPT3CL Cloud
3 oz. (88.7 mL)
3 1/4" Dia. x 1 3/4" H (8.3 x 4.4 cm)



THE JANE COLLECTION

Dinnerware has a new standard. The Jane Collection, our “basic” dinnerware line, is anything but ordinary. Simple and versatile by design, these plates, bowls, cups, platters and even sauce cups serve as ideal backdrops for all types of menu items. From low-key lunches to gastronomically-inspired dinners, the possibilities are practically endless.

We chose to craft the Jane Collection from melamine for two reasons: First, it's exceptionally resilient to the bumps, bangs and bounces that find their way into every kitchen. This dinnerware is in it for the long haul. Second, melamine is dishwasher-safe. No matter how you're inspired to fill these blank canvases, cleaning and reusing them is a cinch.



THE JANE COLLECTION



Wide Rim Plate
DPW10WH White
10 ½" Dia. x ¾" H (26.7 x 1.9 cm)



Wide Rim Plate
DPW9WH White
9" Dia. x ¾" H (22.9 x 1.9 cm)



Wide Rim Plate
DPW7WH White
7 ½" Dia. x ¾" H (19.1 x 1.6 cm)



Wide Rim B&B Plate
DPW6WH White
6 ½" Dia. x ⅝" H (16.5 x 1.6 cm)



Narrow Rim Plate
DPN10WH White
10 ½" Dia. x ¾" H (26.7 x 1.9 cm)



Narrow Rim Plate
DPN9WH White
9" Dia. x ¾" H (22.9 x 1.9 cm)



Narrow Rim Plate
DPN7WH White
7 ½" Dia. x ⅝" H (19.1 x 1.6 cm)



Narrow Rim B&B Plate
DPN6WH White
6 ½" Dia. x ⅝" H (16.5 x 1.6 cm)



Saucer
DS5WH White
5 ½" Dia. x ⅝" H (14 x 1.6 cm)



Oval Platter
DPL12WH White
12" L x 9" W x 7/8" H (30.5 x 22.9 x 2.2 cm)



Oval Platter
DPL9WH White
9 ¾" L x 7 ¼" W x ½" H (24.8 x 18.4 x 1.3 cm)



Stackable Mug
DM10WH White
10 oz. (295.7 mL)
3" Dia. x 3 ⅝" H (7.6 x 9.2 cm)



Wide Rim Bowl
DBW16WH White
 16 oz. (473.2 mL)
 9 1/4" Dia. x 1 1/4" H (23.5 x 3.2 cm)



Narrow Rim Bowl
DBN32WH White
 32 oz. (946.4 mL)
 8 1/2" Dia. x 2 3/8" H (21.6 x 6 cm)



Narrow Rim Bowl
DBN24WH White
 24 oz. (709.8 mL)
 7 3/4" Dia. x 2 1/8" H (19.7 x 5.4 cm)



Narrow Rim Bowl
DBN16WH White
 16 oz. (473.2 mL)
 7 1/4" Dia. x 1 7/8" H (18.4 x 4.8 cm)



Bowl
DB12WH White
 12 oz. (354.9 mL)
 6 5/8" Dia. x 1 1/2" H (16.8 x 3.8 cm)



Bowl
DB8WH White
 8 oz. (236.6 mL)
 6" Dia. x 1 3/8" H (15.2 x 3.5 cm)



Fruit Bowl
DB5WH White
 5 oz. (147.9 mL)
 5" Dia. x 1 3/8" H (12.7 x 3.5 cm)



Bouillon Cup
DB10WH White
 10 oz. (295.7 mL)
 4 1/2" Dia. x 2 1/4" H (11.4 x 5.7 cm)



Bouillon Cup
DB7WH White
 7 oz. (207 mL)
 4" Dia. x 2 1/8" H (10.2 x 5.4 cm)



Sauce Cup
MSC8 White
 8 oz. (236.6 mL)
 3 5/8" Dia. x 2 1/8" H (9.2 x 5.4 cm)



Sauce Cup
DSC3WH White
 2 3/4 oz. (81.3 mL)
 3 1/2" Dia. x 1" H (8.9 x 2.5 cm)



Sauce Cup
DSC1WH White
 1 oz. (29.6 mL)
 2 3/4" Dia. x 7/8" H (7 x 2.2 cm)



PAIRS WELL WITH THE JANE COLLECTION

THE JANE CASUAL COLLECTION



The Jane Casual Collection pairs the simple styling of the Jane Collection with fun, friendly finishes inspired by linen and denim. Crafted from durable melamine, these plates, bowls and serving platters let you turn any meal into comfort food.

Please add **LN** for Linen or **DN** for Denim to the end of the item number to designate color choice when ordering.



Narrow Rim Plate
DPN10LN Linen **DPN10DN** Denim
 10 1/2" Dia. x 3/4" H
 (26.7 x 1.9 cm)



Narrow Rim Plate
DPN9LN Linen **DPN9DN** Denim
 9" Dia. x 3/4" H
 (22.9 x 1.9 cm)



Narrow Rim Bowl
DBN16LN Linen **DBN16DN** Denim
 16 oz. (473.2 mL)
 7 1/4" Dia. x 1 7/8" H (18.4 x 4.8 cm)



Bouillon Cup
DB10LN Linen **DB10DN** Denim
 10 oz. (295.7 mL)
 4 1/2" Dia. x 2 1/4" H (11.4 x 5.7 cm)



Oval Platter
DPL12LN Linen **DPL12DN** Denim
 12" L x 9" W x 7/8" H
 (30.5 x 22.9 x 2.2 cm)



THE ANI COLLECTION

A marriage of economical and modish, the Ani Collection is the perfect way to give a subtle boost to your tabletop. Its cool, crisp design provides an ideal, affordable base for any tablescape.

Made of durable, NSF-approved melamine and available in all popular shapes and sizes, the Ani Collection provides a complete tabletop solution for anyone from small independent restaurants to high-volume dining halls.

NEW



NEW





Coupe Plate
ARP10WH White
 10 ½" Dia. x 1" H
 (26.7 x 2.5 cm)



Coupe Plate
ARP9WH White
 8 ⅞" Dia. x ⅞" H
 (22.5 x 2.2 cm)



Coupe Plate
ARP7WH White
 7 ½" Dia. x ¾" H
 (19.1 x 1.9 cm)



Coupe Plate
ARP6WH White
 6 ¼" Dia. x ¾" H
 (15.9 x 1.9 cm)



Rectangular Platter
AP12WH White
 12" L x 7" W x ⅞" H
 (30.5 x 17.8 x 2.2 cm)



Bowl
AB30WH White
 30 oz. (887.2 mL)
 9" Dia. x 1 ¼" H
 (22.9 x 3.2 cm)



Bowl
AB16WH White
 16 oz. (473.2 mL)
 5" Dia. x 2 ¼" H
 (12.7 x 5.7 cm)



Bowl
AB12WH White
 12 oz. (354.9 mL)
 4 ½" Dia. x 2" H
 (11.4 x 5.1 cm)



Bowl
AB10WH White
 10 oz. (295.7 mL)
 4" Dia. x 2 ⅛" H
 (10.2 x 5.4 cm)



THE BLEND COLLECTION

Bento-inspired pieces and subtle colors intermingle together in a beautiful dinnerware puzzle of fun. The Blend Collection: Deconstructing today's love of compartments into a versatile array of presentation options. Each item is designed to be pieced together (like a puzzle) for an endless number of menu solutions. Use the deep-sided bowls for anything from soups to salads to sauces while the plates offer a home for sandwiches, snacks, and sides. Plus, each plate mindfully doubles as a lid for each bowl thus offering a covered option to keep food fresh. These functional pieces artfully blend together in a subtle neutral canvas ready for creative and colorful food plating.





THE BLEND COLLECTION



Plate
BPR128CR Cream
 12 ¼" L x 8 ¼" W x ¾" H
 (31.1 x 21 x 1.9 cm)



Plate/Lid
BPS8CR Cream
 7 ⅞" Sq. x ⅝" H
 (20 x 1.6 cm)



Bowl
BBS44CR Cream
 44 oz. (1.3 L)
 7 ⅞" Sq. x 2" H
 (20 x 5.1 cm)



Plate/Lid
BPR84BI Biscuit
 7 ⅞" L x 4" W x ⅝" H
 (20 x 10.2 x 1.6 cm)



Bowl
BBR20BI Biscuit
 20 oz. (591.5 mL)
 7 ⅞" L x 4" W x 2" H
 (20 x 10.2 x 5.1 cm)



Plate/Lid
BPS4CO Coffee
 4" Sq. x ⅝" H
 (10.2 x 1.6 cm)



Bowl
BBS9CO Coffee
 9 oz. (266.2 mL)
 4" Sq. x 2" H
 (10.2 x 5.1 cm)



Plate/Lid
BPR42CO Coffee
 4" L x 2" W x ⅝" H
 (10.2 x 5.1 x 1.6 cm)



Bowl
BBR4CO Coffee
 4 oz. (118.3 mL)
 4" L x 2" W x 2" H
 (10.2 x 5.1 x 5.1 cm)

RESILIENT MELAMINE MEANS THE ISABELLA COLLECTION IMPRESSES IN AL FRESCO SETTINGS TOO



BLUP5

BLUP14

From smallest
to largest:
BLUP6
BLUP8
BLUP11

THE ISABELLA COLLECTION

NSF

BPA
FREE

Inspired by classic china, these timelessly nostalgic pieces feature beautiful floral designs that could pass as individually made. Whether you use them to serve entrées, hors d'oeuvres or desserts, your customers just might be transported to a Florentine patio when this collection reaches the table. Because the Isabella Collection is crafted from BPA-free, NSF-approved melamine, you can create elegant presentations day after day and night after night without concerns of safety or durability.



Plate
BLUP11
11" Dia. x 1" H
(27.9 x 2.5 cm)



Scalloped Plate
BLUP8
8 ¾" Dia. x 1" H
(22.2 x 2.5 cm)



Plate
BLUP6
6 ½" Dia. x ¾" H
(16.5 x 1.6 cm)



Coupe Bowl
BLUP5
6 oz. (177.4 mL)
5" Dia. x 1" H
(12.7 x 2.5 cm)



Rectangular Platter
BLUP14
14" L x 5 ½" W x 1 ¼" H
(35.6 x 14.3 x 3.2 cm)



THE DEL MAR COLLECTION BPA FREE

Poolside food service presents a unique set of challenges, and the Del Mar Collection is designed to meet all of them. Crafted from lightweight ABS plastic (a BPA-free, dishwasher-safe material), these stackable serving boxes can be used as both delivery trays and dinnerware. With stylish water-inspired details and modular design, they're the ideal way to present light fare indoors and out. Just remember to wait 30 minutes before going back in.

Rectangular Serving Bowls and Lids

Gray

BL11G Lid/Platter
11 3/8" L x 8 3/8" W x 1 1/8" H
(28.9 x 21.3 x 2.9 cm)

B11G Bowl
96 oz. (2.8 L)
11" L x 7 7/8" W x 3" H
(28 x 20 x 7.6 cm)

BL14G Lid/Platter
14 1/4" L x 10 1/2" W x 1 1/8" H
(36.2 x 26.7 x 2.9 cm)

B14G Bowl
156 oz. (4.6 L)
13 7/8" L x 10" W x 3" H
(35.2 x 25.4 x 7.6 cm)

White

BL11W Lid/Platter
11 3/8" L x 8 3/8" W x 1 1/8" H
(28.9 x 21.3 x 2.9 cm)

B11W Bowl
96 oz. (2.8 L)
11" L x 7 7/8" W x 3" H
(28 x 20 x 7.6 cm)

BL14W Lid/Platter
14 1/4" L x 10 1/2" W x 1 1/8" H
(36.2 x 26.7 x 2.9 cm)

B14W Bowl
156 oz. (4.6 L)
13 7/8" L x 10" W x 3" H
(35.2 x 25.4 x 7.6 cm)

Rectangular Serving Bowl Inserts

B114W 1/4-Size Insert for B11G and B11W
16 oz. (473.2 mL)
5 1/4" L x 3 3/4" W x 2 5/8" H
(13.3 x 9.5 x 6.7 cm)

B144W 1/4-Size Insert for B14G and B14W
30 oz. (887.2 mL)
6 3/4" L x 4 7/8" W x 2 5/8" H
(17.1 x 12.4 x 6.7 cm)

B112W 1/2-Size Insert for B11G and B11W
38 oz. (1.1 L)
7 5/8" L x 5 1/4" W x 2 5/8" H
(19.4 x 13.3 x 6.7 cm)

B142W 1/2-Size Insert for B14G and B14W
66 oz. (2 L)
9 3/4" L x 6 3/4" W x 2 5/8" H
(24.8 x 17.1 x 6.7 cm)



Round Serving Bowls and Lids

Gray

BL10G Lid/Plate
10 3/8" Dia. x 1 1/8" H
(26.4 x 2.9 cm)

B10G Bowl
80 oz. (2.4 L)
10" Dia. x 3" H
(25.4 x 7.6 cm)

BL12G Lid/Plate
12 3/8" Dia. x 1 1/8" H
(31.4 x 2.9 cm)

B12G Bowl
118 oz. (3.5 L)
12" Dia. x 3" H
(30.5 x 7.6 cm)

White

BL10W Lid/Plate
10 3/8" Dia. x 1 1/8" H
(26.4 x 2.9 cm)

B10W Bowl
80 oz. (2.4 L)
10" Dia. x 3" H
(25.4 x 7.6 cm)

BL12W Lid/Plate
12 3/8" Dia. x 1 1/8" H
(31.4 x 2.9 cm)

B12W Bowl
118 oz. (3.5 L)
12" Dia. x 3" H
(30.5 x 7.6 cm)

Round Serving Bowl Inserts

B104W 1/4-Size Insert for B10G and B10W
15 oz. (443.6 mL)
4 3/4" L x 4 3/4" W x 2 5/8" H
(12.1 x 12.1 x 6.7 cm)

B124W 1/4-Size Insert for B12G and B12W
24 oz. (709.8 mL)
5 3/4" L x 5 3/4" W x 2 5/8" H
(14.6 x 14.6 x 6.7 cm)

B102W 1/2-Size Insert for B10G and B10W
34 oz. (1 L)
9 1/2" L x 4 3/4" W x 2 5/8" H
(24.1 x 12.1 x 6.7 cm)

B122W 1/2-Size Insert for B12G and B12W
52 oz. (1.5 L)
11 1/2" L x 5 3/4" W x 2 5/8" H
(29.2 x 14.6 x 6.7 cm)





BENTO BOXES ARE CONVENIENTLY STACKABLE

Naturals Collection

Bento Boxes BPA FREE

Meal delivery has received a beautiful makeover with the Naturals Collection Bento Box. Sleek and stylish with a hint of marble, each box is durable and stackable with matching lids. Choose from boxes with or without compartments for added versatility.

- BB5WH** 5-Compartment White Bento Box
10 7/8" L x 8 1/4" W x 2" H
(27.6 x 21 x 5.1 cm)
- BB1WH** White Bento Box
10 7/8" L x 8 1/4" W x 2 3/4" H
(27.6 x 21 x 7 cm)
- BBLWH** White Lid/Tray
10 7/8" L x 8 1/4" W x 3/4" H
(27.6 x 21 x 1.9 cm)
- BBLWM** White Marble Lid/Tray
10 7/8" L x 8 1/4" W x 3/4" H
(27.6 x 21 x 1.9 cm)

Shallow Round Melamine Bowls BPA FREE

Whether you serve poke bowls, açai bowls or regular old mac & cheese, these beautiful white pieces will present your creations with style.

- MELR5** 8 oz. (236.6 mL)
5 1/4" Dia. x 1" H (13.3 x 2.5 cm)
- MELR6** 14 oz. (414 mL)
6 5/8" Dia. x 1 3/8" H (16.8 x 3.5 cm)
- MELR8** 28 oz. (828 mL)
8" Dia. x 1 3/4" H (20.3 x 4.4 cm)
- MELR9** 46 oz. (1.4 L)
9 1/2" Dia. x 2 1/8" H (24.1 x 5.4 cm)
- MELR11** 86 oz. (2.5 L)
11 1/4" Dia. x 2 3/8" H (28.6 x 6 cm)



Melamine Paper Plates BPA FREE

Much more durable than its cardboard counterparts, pure white melamine pieces are whimsically designed like paper plates, but dress up events with their look and feel.

- MP6** 5 7/8" Dia. x 5/8" H
(14.9 x 1.6 cm)
- MP7** 7 3/8" Dia. x 5/8" H
(18.7 x 1.6 cm)
- MP9** 8 7/8" Dia. x 5/8" H
(22.5 x 1.6 cm)
- MP11** 10 7/8" Dia. x 3/4" H
(27.6 x 1.9 cm)



Tabletop Accessories



HOT



TSH3

REVERSIBLE DESIGN FOR
EXCEPTIONAL VERSATILITY

HOT



TSH5

TSH3

TSH1



Taco Holders **HOT**

In brushed stainless steel, these holders are a fun, modern way to serve anything from tacos to hot dogs to cannoli.

Full-Size

- TSH1** 1 or 2 Compartments
5" L x 4" W x 2" H
(12.7 x 10.2 x 5.1 cm)
- TSH3** 2 or 3 Compartments
8" L x 4" W x 2" H
(20.3 x 10.2 x 5.1 cm)
- TSH5** 4 or 5 Compartments
13 ¼" L x 4" W x 2" H
(33.7 x 10.2 x 5.1 cm)

Half-Size

- HTSH1** 1 or 2 Compartments
5" L x 2" W x 2" H
(12.7 x 5.1 x 5.1 cm)
- HTSH3** 2 or 3 Compartments
8" L x 2" W x 2" H
(20.3 x 5.1 x 5.1 cm)
- HTSH5** 4 or 5 Compartments
13 ¼" L x 2" W x 2" H
(33.7 x 5.1 x 5.1 cm)

Mini

- MTSH1** 1 or 2 Compartments
2" L x 2" W x 1" H
(5.1 x 5.1 x 2.5 cm)
- MTSH3** 2 or 3 Compartments
4" L x 2" W x 1" H
(10.2 x 5.1 x 2.5 cm)
- MTSH5** 4 or 5 Compartments
7" L x 2" W x 1" H
(17.8 x 5.1 x 2.5 cm)





THMW3 shown with FSR11 serving peel and MB3 sauce cup

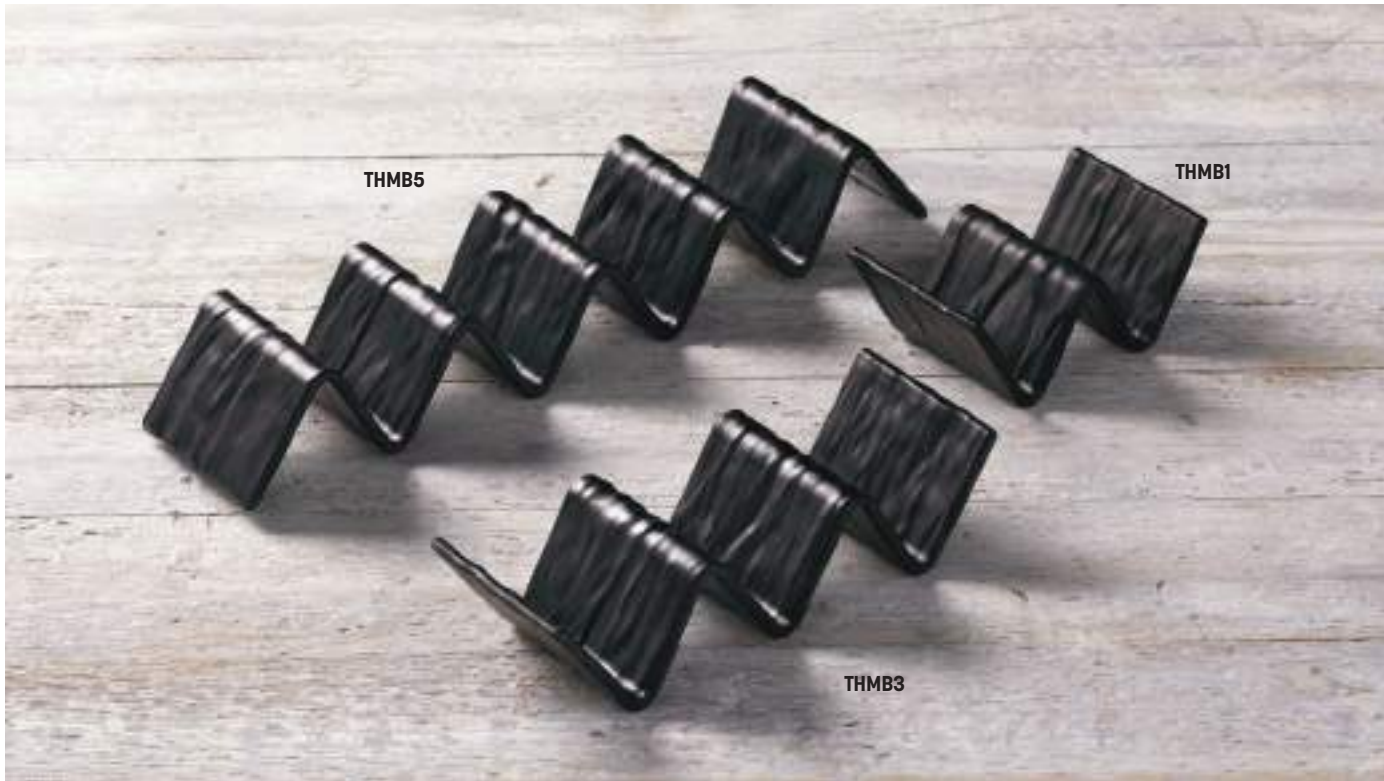

THMB5

THMB1

THMB3

Faux Slate Melamine

Taco Holders

These must-have pieces pair two trends: the look of slate and the love of tacos. Each of these reversible designs is crafted from dishwasher-safe melamine.

White

THMW1 1 or 2 Compartments
5" L x 3" W x 2" H
(12.7 x 7.6 x 5.1 cm)

THMW3 2 or 3 Compartments
8" L x 3" W x 2" H
(20.3 x 7.6 x 5.1 cm)

THMW5 4 or 5 Compartments
13 ¼" L x 3" W x 2" H
(33.7 x 7.6 x 5.1 cm)

Black

THMB1 1 or 2 Compartments
5" L x 3" W x 2" H
(12.7 x 7.6 x 5.1 cm)

THMB3 2 or 3 Compartments
8" L x 3" W x 2" H
(20.3 x 7.6 x 5.1 cm)

THMB5 4 or 5 Compartments
13 ¼" L x 3" W x 2" H
(33.7 x 7.6 x 5.1 cm)

Terra Cotta

THMT1 1 or 2 Compartments
5" L x 3" W x 2" H
(12.7 x 7.6 x 5.1 cm)

THMT3 2 or 3 Compartments
8" L x 3" W x 2" H
(20.3 x 7.6 x 5.1 cm)

THMT5 4 or 5 Compartments
13 ¼" L x 3" W x 2" H
(33.7 x 7.6 x 5.1 cm)

Acacia Wood Taco Holder

This is one of those designs that will make your customers say, "Why haven't I seen this before?" This beautiful, surprisingly simple piece holds up to eight tacos and delivers instant delight.

THW8 8-Compartment
16 ½" L x 2 ¾" W x 2 ¾" H
(41 x 7 x 6 cm)





THESE TINY POTS RANGE
FROM JUST 4 OZ. TO 24 OZ.

MPL24

MPL14

MPL8

MPL4



MPS22 shown on
TRV085 silicone trivet
with HAMSC sauce cup
and SSSK knife

MPS14

Mini Pots with Lids

There's nothing miniature about the charm and nostalgia created by these stainless steel replicas.

MPL4 4 oz. (118.3 mL)
2 5/8" Dia. x 1 3/4" H
3 1/4" L with Handles
(6.7 x 4.4, 8.3 cm)

MPL8 8 oz. (236.6 mL)
3 1/2" Dia. x 2 1/2" H
4" L with Handles
(8.9 x 6.3, 10.2 cm)

MPL14 14 oz. (414 mL)
4 1/4" Dia. x 3" H
5 1/2" L with Handles
(10.8 x 7.6, 14 cm)

MPL24 24 oz. (709.8 mL)
5" Dia. x 3 1/4" H
6 1/4" L with Handles
(12.7 x 8.3, 15.9 cm)

Oval Hammered Mini Skillets

These stainless steel skillets are individually hammered for oven-to-table elegance.

MPS14 14 oz. (414 mL)
6 3/4" L x 5 1/2" W x 1 1/2" H
11 3/4" L with Handle
(17.1 x 14 x 3.8, 29.8 cm)

MPS22 22 oz. (650.6 mL)
8" L x 6 1/4" W x 1 3/8" H
12 5/8" L with Handle
(20.3 x 15.9 x 3.5, 32.1 cm)

Mini Cookware

Creative appetizers and desserts call for creative stainless steel serving vessels.

Pots

- SHSP21** 5 oz. (147.9 mL)
2 ¾" Dia. x 1 ¾" H
5 ½" L with Handle
(7.0 x 4.4, 14 cm)
- SHSP32** 12 oz. (354.9 mL)
3 ½" Dia. x 2 ½" H
6 ¼" L with Handle
(8.9 x 6.3, 15.9 cm)
- SHSP53** 27 oz. (798.5 mL)
4 ¾" Dia. x 3" H
9 ¼" L with Handle
(12.1 x 7.6, 23.5 cm)

Fry Pans

- SHSP20** 2 ½ oz. (73.9 mL)
2 ¾" Dia. x 1" H
5 ½" L with Handle
(7 x 2.5, 14 cm)
- SHSP40** 7 ½ oz. (221.8 mL)
4" Dia. x 1 ¼" H
7 ½" L with Handle
(10.2 x 3.2, 19.1 cm)
- SHSP41** 13 oz. (384.5 mL)
4 ¾" Dia. x 1 ½" H
9 ⅛" L with Handle
(12.1 x 3.8, 23.2 cm)

Mini Roasting Pans

A customer favorite, these petite stainless steel roasting pans deliver practicality and pretty presentation.

- MRPS45** 14 oz. (414 mL)
4 ½" Sq. x 1 ¾" H
6 ⅞" L with Handles
(11.4 x 4.4, 15.6 cm)
- MRP53** 17 oz. (502.8 mL)
5 ¾" L x 3 ¾" W x 1 ¾" H
7 ¼" L with Handles
(14.6 x 9.5 x 4.4, 18.4 cm)



Top to bottom:

- BSPP4
- BSPP6
- BSPP8
- BSPP9
- BSPP11



Black Steel Paella Pans

Just like the real thing, these smaller versions of traditional paella pans are sure to be crowd pleasers. Made of black steel, these pans can withstand high heat either from the oven, broiler or induction burner. Perfect for oven-to-table entrees, individual portions or sides.

- BSPP4** 8 oz. (236.6 mL)
4 7/8" Dia. x 1 1/8" H, 6" L with Handles
(12.4 x 2.8, 15.2 cm)
- BSPP5** 13 oz. (384.5 mL)
5 3/8" Dia. x 1 1/4" H, 6 3/4" L with Handles
(14.3 x 3.2, 17.1 cm)
- BSPP6** 18 oz. (532.3 mL)
6 1/2" Dia. x 1 3/8" H, 7 5/8" L with Handles
(16.5 x 3.5, 19.4 cm)
- BSPP8** 30 oz. (887.2 mL)
8" Dia. x 1 1/2" H, 9 1/2" L with Handles
(20.3 x 3.8, 24.1 cm)
- BSPP9** 52 oz. (1.5 L)
9 1/2" Dia. x 1 7/8" H, 11" L with Handles
(24.1 x 4.8, 27.9 cm)
- BSPP11** 82 oz. (2.4 L)
11" Dia. x 2" H, 12 1/4" L with Handles
(27.9 x 5.1, 31.1 cm)
- BSPP12** 126 oz. (3.7 L)
12 5/8" Dia. x 2 1/4" H, 14" L with Handles
(32 x 5.7, 35.6 cm)

Shown with HM11CMF fork and HM8TNG tongs



Stainless Steel Balti Dishes

It's easy to see your own creations making an impact with the help of the beautiful mirror finish on these pieces. Stylish handles make transport easy.

- BD35** 10 oz. (295.7 mL)
4 1/4" Dia. x 2 3/4" H, 4 3/4" W with Handles
(10.8 x 7, 12.1 cm)
- BD45** 16 oz. (473.2 mL)
5 1/8" Dia. x 2 1/2" H, 6 1/2" W with Handles
(13 x 6.4, 16.5 cm)
- BD55** 18 oz. (532.3 mL)
5 3/4" Dia. x 2 3/4" H, 7 1/4" W with Handles
(14.6 x 7, 18.4 cm)
- BD65** 32 oz. (946.4 mL)
6 5/8" Dia. x 3 1/4" H, 8" W with Handles
(16.9 x 8.3, 20.3 cm)
- BD72** 40 oz. (1.2 L)
7" Dia. x 4" H, 8 7/8" W with Handles
(17.8 x 10.2, 22.5 cm)
- BD87** 62 oz. (1.8 L)
8 1/8" Dia. x 4 1/4" H, 9 7/8" W with Handles
(20.6 x 10.8, 25.1 cm)
- BD93** 105 oz. (3.1 L)
9 3/8" Dia. x 4 3/4" H, 11" W with Handles
(23.8 x 12.1, 27.9 cm)





Sizzle Platters

Mirror-finished aluminum allows for maximum sizzle while moving from oven to table.

PLA710 Sizzle Platter
10 1/2" L x 7" W
(26.7 x 17.8 cm)

PLA810 Sizzle Platter
11 1/2" L x 8" W
(29.2 x 20.3 cm)

PLA912 Sizzle Platter
12 1/2" L x 9" W
(31.8 x 22.9 cm)

Stainless Steel Mussel Server

Elevate mussels and fish stews with this nautically elegant server.

SSMS9 64 oz. (1.9 L) Server with Lid
7" Dia. x 6 3/4" H, 9" W with Handles
(17.8 x 17.1, 22.9 cm)





CAST IRON

Take our pre-seasoned cast iron pots, pans and casseroles out of the oven and onto the table. Larger sizes available on pg. 182.

Fry Pans and Casseroles

- CIPRT5336** 9 ½ oz. (280.9 mL)
5 ¾" L x 3 ⅝" W x 1 ½" H, 7" L with Handles
(13.7 x 9.2 x 4.1, 17.8 cm)
- CIPS61** 9 ½ oz. (280.9 mL)
5 ¾" Sq. x ⅞" H, 7 ⅞" L with Handles
(14.6 x 2.2, 18.1 cm)
- CIS41** 3 ½ oz. (103.5 mL)
3 ⅞" Dia. x 1" H, 6 ⅞" L with Handle
(9.8 x 2.5, 17.5 cm)
- CIS51** 8 ½ oz. (251.4 mL)
5" Dia. x 1 ½" H, 8 ¼" L with Handle
(12.7 x 3.8, 21 cm)
- CIS61** 15 ½ oz. (458.4 mL)
6 ¼" Dia. x 1 ¼" H, 10" L with Handle
(15.9 x 3.2, 25.4 cm)



Round Casseroles and Pots

- CIPR5125** 8 ½ oz. (251.4 mL)
5" Dia. x 1 ¼" H, 6 ½" L with Handles
(12.7 x 3.2, 16.5 cm)
- CIPR6250** 19 oz. (561.9 mL)
6 ¼" Dia. x 1 ½" H, 8 ¾" L with Handles
(15.9 x 3.8, 22.2 cm)
- CIPR7251** 27 oz. (798.5 mL)
7 ¼" Dia. x 1 ¾" H, 9 ⅝" L with Handles
(18.4 x 4.4, 24.5 cm)
- CIPR42** 9 oz. (266.2 mL)
4" Dia. x 2" H, 5 ⅝" L with Handles, 3" H with Knob
(12.7 x 5.1, 14.3, 6 cm)
- CIPR5500** 19 oz. (561.9 mL)
5" Dia. x 2 ¼" H, 6 ½" L with Handles, 3 ¾" H with Knob
(12.7 x 5.7, 16.5, 9.5 cm)
- CIPR5526** 27 oz. (798.5 mL)
5 ½" Dia. x 2 ⅝" H, 7 ⅝" L with Handles, 4" H with Knob
(14 x 6.6, 19.4, 10.2 cm)



Oval Casseroles and Pots

- CIPOV856** 27 oz. (798.5 mL)
8 ½" L x 6" W x 1 ¾" H, 10 ⅞" L with Handles
(21.6 x 15.2 x 4.5, 27.6 cm)
- CIPOV9567** 36 ½ oz. (1.1 L)
9 ½" L x 6 ⅜" W x 2" H, 12" L with Handles
(24.1 x 16.2 x 5.1, 30.5 cm)
- CIPOV63** 11 ½ oz. (340.1 mL)
5" L x 2 ⅝" W x 2" H, 6 ½" L with Handles, 3" H with Knob
(12.7 x 6.7 x 5, 16.5, 7.6 cm)
- CIPOV6040** 17 ½ oz. (517.5 mL)
6" L x 4" W x 2 ½" H, 7 ½" L with Handles, 3 ⅞" H with Knob
(15.2 x 10.2 x 6.4, 19.1, 9.8 cm)
- CIPOV745** 23 ½ oz. (695 mL)
7" L x 4 ½" W x 2 ¼" H, 8 ½" L with Handles, 4" H with Knob
(17.8 x 11.4 x 5.7, 21.6, 10.2 cm)



Mini Griddle

- CIG85** 8 ¼" L x 5 ¾" W x ¾" H, 9 ½" L with Handles
(21 x 14.6 x 1.9, 24.1 cm)

Mini Cast Iron Fondue Pot and Stand

- CIFD** Cast Iron Pot, 12 ½ oz. (369.7 mL)
4 ⅝" Dia. x 1 ¾" H, 7 ⅞" L with Handle
(11.7 x 4.5, 18.1 cm)
- CIFDR** Stainless Steel Stand
5" Dia. x 3 ¼" H
(12.7 x 8.3 cm) (Tea lights not included)



Silicone Trivets

- TRVR5** Round
5" Dia. x ¼" H
(12.7 x 0.6 cm)
- TRVR675** Round
6 ¾" Dia. x ¼" H
(17.1 x 0.6 cm)
- TRV053** Oval
5 ½" L x 3 ¾" W x ¼" H
(14 x 9.5 x 0.6 cm)
- TRV085** Oval
8 ¾" L x 5 ⅞" W x ¼" H
(22.2 x 14.9 x 0.6 cm)
- TRVS6** Square
6" Sq. x ¼" H
(15.2 x 0.6 cm) (not shown)
- TRV875** Rectangular
8 ¾" L x 6 ½" W x ¼" H
(22.2 x 16.5 x 0.6 cm) (not shown)



Steak Knives

- KNF2** Black Plastic Handle, Rounded Tip
5" L Blade, 9" L Overall
(12.7 x 22.9 cm)
- KNF7** Pom, Full Tang, Pointed Tip
4 ½" L Blade, 8 ¾" L Overall
(11.4 x 22.2 cm)
- KNF6** Jumbo Black Plastic, Rounded Tip
5" L Blade, 10" L Overall
(12.7 x 25.4 cm)
- KNF3** Hardwood Handle, Rounded Tip
5 ⅞" L Blade, 10" L Overall
(13 x 25.4 cm)
- KNF4** Pakkawood Handle, Pointed Tip
4 ¾" L Blade, 8" L Overall
(11.1 x 20.3 cm)
- KNF8** Jumbo Black Pom, Full Tang, Rounded Tip
5" L Blade, 10" L Overall
(12.7 x 25.4 cm)
- SSKNF9** Satin Finish
5" L Blade, 9" L Overall
(12.7 x 22.9 cm)
- SSKNF8** Mirror Finish
5" L Blade, 9" L Overall
(12.7 x 22.9 cm)
- SSSK** Jumbo Black Pom, Full Tang
5 ⅞" L Blade, 10 ¼" L Overall
(13 x 26 cm)





Melamine Cast Iron Pots

The rustic look of cast iron meets the lightweight of melamine in these serving dishes. They're easy to wash and even easier to carry. Not for oven or stove use.

Black

MC61 Oval Casserole, 5 oz. (147.9 mL)
 4 3/4" L x 3" W x 1 1/4" H
 6" L with Handles
 (12.1 x 7.6 x 3.2, 15.2 cm)

MC41 Round Casserole, 6 oz. (177.4 mL)
 4 3/8" Dia. x 1 1/4" H
 6" L with Handles
 (11.1 x 3.2, 15.2 cm)

MFP41 Fry Pan, 6 oz. (177.4 mL)
 4 3/8" Dia. x 1 1/4" H
 6 1/4" L with Handle
 (12.1 x 3.2, 15.9 cm)

MCR72 Round Casserole, 39 oz. (1.2 L)
 7 5/8" Dia. x 2 3/8" H
 9 7/8" L with Handles
 (19.4 x 6, 25.1 cm)

MC81 Oval Casserole, 13 oz. (384.5 mL)
 8 1/4" L x 5 1/2" W x 1 1/2" H
 10 3/8" L with Handles
 (21 x 14 x 3.4, 26.4 cm)

MFP81 Fry Pan, 24 oz. (709.8 mL)
 8 1/2" Dia. x 1 1/4" H
 12" L with Handles
 (21.6 x 3.2, 30.5 cm)

MB93 Round Bowl, 82 oz. (2.4 L)
 9 3/4" Dia. x 3 1/4" H
 12 1/2" L with Handles
 (24.8 x 8.3, 31.8 cm)



White

- MCW61** Oval Casserole, 5 oz. (147.9 mL)
4 3/4" L x 3" W x 1 1/4" H
6" L with Handles
(12.1 x 7.6 x 3.2, 15.2 cm)
- MCW41** Round Casserole, 6 oz. (177.4 mL)
4 3/8" Dia. x 1 1/4" H
6" L with Handles
(11.1 x 3.2, 15.2 cm)
- MFPW41** Fry Pan, 6 oz. (177.4 mL)
4 3/8" Dia. x 1 1/4" H
6 1/4" L with Handle
(12.1 x 3.2, 15.9 cm)
- MCRW72** Round Casserole, 39 oz. (1.2 L)
7 5/8" Dia. x 2 3/8" H
9 7/8" L with Handles
(19.4 x 6, 25.1 cm)
- MCW81** Oval Casserole, 13 oz. (384.5 mL)
8 1/4" L x 5 1/2" W x 1 1/2" H
10 3/8" L with Handles
(21 x 14 x 3.4, 26.4 cm)
- MFPW81** Fry Pan, 24 oz. (709.8 mL)
8 1/2" Dia. x 1 1/4" H
12" L with Handle
(21.6 x 3.2, 30.5 cm)
- MBW93** Round Bowl, 82 oz. (2.4 L)
9 3/4" Dia. x 3 1/4" H
12 1/2" L with Handles
(24.8 x 8.3, 31.8 cm)





Shown with HAMSCB3 sauce cup



Melamine Cast Iron Serving Peels

Serve up a little personality with your fast-casual meals and sides. These trendy serving peels take on the rustic appearance of cast iron, but are actually crafted of durable, dishwasher-safe melamine. Available in your choice of white or black. Not for oven or stove use.

Black

MSP61 6 7/8" L x 5 1/2" W x 1/2" H
9 1/2" L with Handle
(17.5 x 14 x 1.3, 24.1 cm)

MSP91 9 1/8" L x 7 3/8" W x 1/2" H
12 5/8" L with Handle
(23.2 x 18.7 x 1.3, 32.1 cm)

White

MSPW61 6 7/8" L x 5 1/2" W x 1/2" H
9 1/2" L with Handle
(17.5 x 14 x 1.3, 24.1 cm)

MSPW91 9 1/8" L x 7 3/8" W x 1/2" H
12 5/8" L with Handle
(23.2 x 18.7 x 1.3, 32.1 cm)



Melamine Shovels

NEW **BPA FREE**

Creatively serve appetizers, meals and sides with our shovel-shaped melamine platter. Offered in colors black (Midnight) and gray (Shadow), both sizes provide a textured surface and are perfect for indoor and outdoor use.

Shadow

SP8SH 8 ½" L x 6 ¼" W x 1 ⅝" H
(21.6 x 15.9 x 5.1 cm)

SP10SH 10 ½" L x 7 ¾" W x 2" H
(23.2 x 19.7 x 5.1 cm)

Midnight

SP8MN 8 ½" L x 6 ¼" W x 1 ⅝" H
(21.6 x 15.9 x 5.1 cm)

SP10MN 10 ½" L x 7 ¾" W x 2" H
(23.2 x 19.7 x 5.1 cm)





MSJ5 jars shown with BR15 multifunctional riser

Melamine Square Jars BPA FREE

Our most popular glass square jars are available in durable melamine! Organize, serve and store in these simple and nestable white melamine jars. Use alone or with our condiment racks, even top with a PET lid to keep food covered.

- MSJ3** 10 oz. (295.7 mL)
3" Sq. x 3" H (7.6 x 7.6 cm)
- MSJ4** 22 oz. (650.6 mL)
4" Sq. x 4" H (10.2 x 10.2 cm)
- MSJ5** 44 oz. (1.3 L)
4 7/8" Sq. x 5" H (12.4 x 12.7 cm)

Pet Lids

- LGJ8** 3" Sq. x 3/8" H (7.6 x 1 cm)
(not shown)
- LGJ24** 4" Sq. x 3/8" H (10.2 x 1 cm)
- LGJ40** 5" Sq. x 3/8" H (12.7 x 1 cm)
(not shown)



MSJ4 shown with LGJ24 lid

MSJ5

MSJ3

Terra Cotta Melamine Pots BPA FREE

Customers everywhere are intrigued by these cleverly designed pieces. These pots pair the look of earthenware with the durability you've come to expect from our melamine collection. Bring al fresco color to whatever you serve in them.

- MELPOT2** 3 1/2 oz. (103.5 mL)
2 3/4" Dia. x 2 3/8" H (7 x 6 cm)
- MELPOT8** 8 oz. (236.6 mL)
3 1/2" Dia. x 3 1/8" H (8.9 x 7.9 cm)
- MELPOT14** 16 oz. (473.2 mL)
4 3/8" Dia. x 4" H (11.1 x 10.2 cm)
- MELPOT24** 28 oz. (828.1 mL)
5 1/4" Dia. x 4 3/4" H (13.3 x 12.1 cm)



MELPOT24

MELPOT14

MELPOT2

MELPOT8



Square Glass Jars

Our trendy geometric jars are great for front- and back-of-house. Feeling adventurous? Use them to serve drinks.

- GJ6** 6 oz. (177.4 mL)
2 ½" Sq. x 2 ½" H (6.4 x 6.4 cm)
- GJ8** 8 oz. (236.6 mL)
3" Sq. x 3" H (7.6 x 7.6 cm)
- GJ24** 24 oz. (709.8 mL)
4" Sq. x 4" H (10.2 x 10.2 cm)
- GJ40** 40 oz. (1.2 L)
4 ¾" Sq. x 4 ⅞" H (12.1 x 12.4 cm)

PET Lids

- LGJ6** GJ6 Lid, 2 ⅝" Sq. x ⅜" H (6.7 x 1 cm)
(not shown)
- LGJ8** GJ8 Lid, 3" Sq. x ⅜" H (7.6 x 1 cm)
(not shown)
- LGJ24** GJ24 Lid, 4" Sq. x ⅜" H (10.2 x 1 cm)
- LGJ40** GJ40 Lid, 5" Sq. x ⅜" H (12.7 x 1 cm)
(not shown)

Round Glass Jars

These simple, versatile 4- and 6-oz. jars practically beg for imaginative uses.

- RGJ4** 4 oz. (118.3 mL)
2" Dia. x 2 ⅞" H (5.1 x 7.3 cm)
- RGJ6** 6 oz. (177.4 mL)
2 ⅝" Dia. x 3 ⅛" H (6.7 x 7.9 cm)

Plastic Cap

- LRGJ6** RGJ4 and RGJ6 Lid
2 ⅝" Dia. x ⅜" H (6.7 x 1 cm)



Shown with TAGA8WT mini chalk card



MJ22

MJ85

MJ17

MJ16



LMJ1785

PET LIDS FIT OVER OPENING FOR PREP AND STORAGE

Mason Jars

With the popularity of pickling and fermentation, it's the ideal time to serve food or drinks in these classic glass pieces.

- MJ85** 8 ½ oz. (251.4 mL)
3" Dia. x 4" H (7.6 x 10.2 cm)
- MJ17** 17 oz. (502.8 mL)
3" Dia. x 5 ⅝" H (7.6 x 13.7 cm)
- MJ16** 16 oz. (473.2 mL)
4 ¼" Dia. x 3 ½" H (10.8 x 8.9 cm)
- MJ22** 22 oz. (650.6 mL)
4 ¼" Dia. x 5" H (10.8 x 12.7 cm)

PET Lids

- LMJ1785** MJ17 Lid and MJ85 Lid
2 ⅞" Dia. x ⅜" H (7.3 x 1 cm)
- LMJ1622** MJ16 Lid and MJ22 Lid
3 ⅞" Dia. x ⅜" H (9.8 x 1 cm)
(not shown)



HMJ5

HMJ6

HMJ4

Apothecary Jars

The full-size versions of our rustic apothecary jars are perfect for pickling and presentation alike.

- HMJ4** 16 oz. (473.2 mL)
3 ½" Dia. (4 ½" Dia. with Hinges) x 4" H
(8.9 (11.4) x 10.2 cm)
- HMJ5** 26 oz. (768.9 mL)
3 ½" Dia. (4 ½" Dia. with Hinges) x 5 ½" H
(8.9 (11.4) x 14 cm)
- HMJ6** 35 oz. (1 L)
3 ½" Dia. (4 ¾" Dia. with Hinges) x 6 ½" H
(8.9 (12.1) x 16.5 cm)

Mini Apothecary Jars

Blending the trends of miniatures and jars, these rustic pieces are sure to please.

- HMMJ1** 1 ½ oz. (44.4 mL)
1 ¾" Dia. (2 ½" Dia. with Hinges) x 2 ½" H
(4.4 (6.4) x 6.4 cm)
- HMMJ2** 2 ½ oz. (73.9 mL)
1 ¾" Dia. (2 ½" Dia. with Hinges) x 3 ½" H
(4.4 (6.4) x 8.9 cm)
- HMMJ3** 3 ½ oz. (103.5 mL)
2 ¼" Dia. (3 ¼" Dia. with Hinges) x 2 ¾" H
(5.7 (8.3) x 7 cm)
- HMMJ4** 4 oz. (118.3 mL)
1 ¾" Dia. (2 ½" Dia. with Hinges) x 3 ¼" H
(4.4 (6.4) x 8.3 cm)
- HMMJ5** 5 oz. (147.9 mL)
2 ¼" Dia. (3 ¼" Dia. with Hinges) x 3" H
(5.7 (8.3) x 7.6 cm)



HMMJ3

HMMJ1

HMMJ5

HMMJ2

HMMJ4

Glass Zipper Bag

Your customers will reach for their phones when they see this memorable, social media-worthy glass container.

GZB22 22 oz. (650.6 mL)
5" Dia. x 4 ¾" H (12.7 x 12 cm)

Glass Milk Bottles

With a winsome combination of nostalgia and playfulness, these milk bottles will particularly please at brunches and catered events.

GMB3 3 oz. (88.7 mL)
1 ¾" Dia. x 4" H (4.5 x 10.2 cm)

GMB6 6 oz. (177.4 mL)
2" Dia. x 5" H (5.1 x 12.7 cm)

GMB8 8 oz. (233.6 mL)
2 ¼" Dia. x 5 ½" H (5.7 x 14 cm)

GMB16 16 oz. (473.2 mL)
2 ¾" Dia. x 6 ½" H (7 x 16.5 cm)

GMB32 32 oz. (946.4 mL)
3 ¼" Dia. x 8 ¼" H (8.3 x 21 cm)

PET Lids

LGMB3 GMB3 Lid, 1 ½" Dia. x ¾" H (3.8 x 1 cm)

LGMB68 GMB6 and GMB8 Lid
1 ⅞" Dia. x ¾" H (4.8 x 1 cm)
(not shown)

LGMB16 GMB16 Lid, 2 ¼" Dia. x ¾" H (5.7 x 1 cm)
(not shown)

Plastic Caps

CAP3 GMB3 Lid, 1 ½" Dia. x ¾" H (3.8 x 1 cm)

CAP6 GMB6 Lid, 1 ¾" Dia. x ¾" H (4.4 x 1 cm)
(not shown)

CAP8 GMB8 Lid, 2" Dia. x ¾" H (5.1 x 1 cm)
(not shown)

CAP16 GMB16 and GMB32 Lid, 2 ¾" Dia. x ¾" H
(6 x 1 cm)
(not shown)



GZB22



GMB32

GMB16

GMB8

GMB6

GMB3

LGMB3

CAP3

CHOOSE FROM TWO
TYPES OF PLASTIC LIDS





Stainless Steel Fry Cups HOT

Among our most popular items, these pieces come in different shapes and finishes to make your frites pop.

Straight-Sided

FFC337 Satin Finish
14 oz. (414 mL)
3 3/8" Dia. x 3 3/8" H (8.6 x 8.6 cm)

FFHM37 Hammered Finish
14 oz. (414 mL)
3 3/8" Dia. x 3 3/8" H (8.6 x 8.6 cm)

Angled

FFCS45 Satin Finish
12 oz. (354.9 mL)
2 7/8" Dia. x 4 1/2" H (7.3 x 11.4 cm)

FFHM45 Hammered Finish
12 oz. (354.9 mL)
2 7/8" Dia. x 4 1/2" H (7.3 x 11.4 cm)

Mini Stainless Steel Fry Cups

A shorter take on our popular fry cup design, these pieces are great for mixing up your side service.

FFCM2 Satin Finish
7 oz. (207 mL)
3 1/8" Dia. x 2" H (7.9 x 5.1 cm)

FFHM2 Hammered Finish
7 oz. (207 mL)
3 1/8" Dia. x 2" H (7.9 x 5.1 cm)



Shown with
FFHM37 fry cup,
HAMSC and MBI sauce
cups and MJ17 mason jar



OVERSIZED DESIGN FOR
BIGGER BITES

Large Stainless Steel Fry Cups

Don't let fries have all the fun. Serve appetizers, snacks and other sides in these stainless steel beauties.

FFC335 Satin Finish
24 oz. (709.8 mL)
4" Dia. x 4 ½" H (10.2 x 11.4 cm)

FFHM35 Hammered Finish
24 oz. (709.8 mL)
4" Dia. x 4 ½" H (10.2 x 11.4 cm)

Square Hammered Fry Cups

Our popular stainless steel fry cups with a little more edge. (Four of them, to be exact.)

FCH35 12 oz. (354.9 mL)
3 ¼" Sq. x 3 ½" H (8.3 x 8.9 cm)

FCH325 18 oz. (532.3 mL)
3 ⅝" Sq. x 3 ⅝" H (9.2 x 9.2 cm)



NEW

FFCG337

FFCGH37

DISHWASHER-SAFE
GOLD FINISH



NEW

Gold Fry Cups ^{NEW}

Designed with modern in mind, our gold fry cups are offered in different shapes and finishes. Gold color may vary slightly.

Straight-Sided

FFCG337 Satin Finish
14 oz. (414 mL)
3 3/8" Dia. x 3 3/8" H (8.6 x 8.6 cm)

FFCGH37 Hammered Finish
14 oz. (414 mL)
3 3/8" Dia. x 3 3/8" H (8.6 x 8.6 cm)

Angled

FFCG45 Satin Finish
12 oz. (354.9 mL)
2 7/8" Dia. x 4 1/2" H (7.3 x 11.4 cm)

FFCGH45 Hammered Finish
12 oz. (354.9 mL)
2 7/8" Dia. x 4 1/2" H (7.3 x 11.4 cm)



FFCG45

FFCGH45

Copper Fry Cups

Our most popular fry cup designs are available in upscale copper. Choose from brushed or hammered finishes in angled or straight-sided designs.

Straight-Sided

FFCCS337 Satin Finish
14 oz. (414 mL)
3 3/8" Dia. x 3 3/8" H (8.6 x 8.6 cm)

FFCCH37 Hammered Finish
14 oz. (414 mL)
3 3/8" Dia. x 3 3/8" H (8.6 x 8.6 cm)

Angled

FFCCS45 Satin Finish
12 oz. (354.9 mL)
2 7/8" Dia. x 4 1/2" H (7.3 x 11.4 cm)

FFCCH45 Hammered Finish
12 oz. (354.9 mL)
2 7/8" Dia. x 4 1/2" H (7.3 x 11.4 cm)



Shown with OWM17 olive wood melamine platter





Stainless Steel Soup Cans

In black or silver, these cans elevate an easily overlooked object.

Silver

SCSM 12 oz. (354.9 mL)
2 3/4" Dia. x 3 3/4" H (7 x 9.5 cm)

SCS3 12 oz. (354.9 mL)
2 3/4" Dia. x 3 3/4" H (7 x 9.5 cm)

Black

SCBM 12 oz. (354.9 mL)
2 3/4" Dia. x 3 3/4" H (7 x 9.5 cm)

SCB3 12 oz. (354.9 mL)
2 3/4" Dia. x 3 3/4" H (7 x 9.5 cm)



Shown with SSP2 shakers and TMW13 serving tray

JC12



JC16

JC12

Classic Mint Julep Cups

Featuring elegant beading and a mirrored finish, these stunning cups will have your mint julep presentation off to the races.

JC12 12 oz. (354.9 mL)
3 3/8" Dia. x 4 1/2" H
(8.6 x 11.4 cm)

JC16 16 oz. (473.2 mL)
3 5/8" Dia. x 5 3/4" H
(9.2 x 14.6 cm)

Mint Julep Cups

Serve up Derby Day the other 364 days a year with these brushed stainless steel cups.

JC8 8 oz. (236.6 mL)
2 7/8" Dia. x 3 7/8" H
(7.4 x 9.8 cm)

JC11 11 oz. (325.3 mL)
3" Dia. x 4 1/4" H
(7.6 x 10.8 cm)

JC14 14 oz. (414 mL)
3 1/4" Dia. x 4 5/8" H
(8.3 x 11.8 cm)



JC11

JC14

JC8



GFC45

GFC335

GFC337

Galvanized Fry Cups

With a French bistro look, these cups are a chic way to serve fries and dainty desserts. Not for use with acidic foods.

GFC337 12 oz. (354.9 mL)
3 ¾" Dia. x 3 ¼" H (9.5 x 8.3 cm)

GFC45 Angled, 10 oz. (295.7 mL)
3 ½" Dia. x 4 ½" H (8.9 x 11.4 cm)

GFC335 24 oz. (709.8 mL)
4 ¼" Dia. x 4 ½" H (10.8 x 11.4 cm)

Mini Galvanized Pails

Pair with our larger pails (pg. 80) to stylishly coordinate. Not for use with acidic foods.

GP2 3 oz. (88.7 mL)
2 ½" Dia. x 2 ¾" H (6.4 x 7 cm)

GP3 8 ½ oz. (251.4 mL)
3 ½" Dia. x 3 ⅞" H (8.9 x 9.8 cm)

GP4 26 oz. (768.9 mL)
4 ½" Dia. x 5" H (11.4 x 12.7 cm)



GP3

GP4

GP2

Newspaper Fry Cups

A nod to traditional fish and chips presentation, retro newsprint is the inspiration for this press-worthy design. Sold in packs of 1000.

FFCP4 4 oz. (118.3 mL)
2 ¾" Dia. x 4 ⅜" H (7 x 11.1 cm)

FFCP6 6 oz. (177.4 mL)
2 ⅞" Dia. x 5 ¼" H (7.3 x 13.3 cm)



FFCP6

FFCP4

Mini Stainless Steel Pails HOT

- SSP25** 6 oz. (177.4 mL)
2 1/2" Dia. x 2 3/4" H (6.4 x 7 cm)
- SSP35** 12 oz. (354.9 mL)
3 1/2" Dia. x 3 1/4" H (8.9 x 8.3 cm)
- SSP43** 1 qt. (946.4 mL)
5" Dia. x 4 5/8" H (12.7 x 11.7 cm)
- SSP61** 2 qt. (1.9 L)
6 1/4" Dia. x 5 3/4" H (15.9 x 14.6 cm)

HOT



MIRRORED
STAINLESS STEEL
WORKS IN ANY
SETTING

Mini Stainless Steel Trash Cans

- OSCAR** Can
14 oz. (414 mL)
3 3/4" Dia. x 3 1/2" H (9.5 x 8.9 cm)
- OLID** Lid for OSCAR
3 3/4" Dia. x 1 1/2" H (9.5 x 3.8 cm)
- OSCAR2** Can
1 qt. (946.4 mL)
5" Dia. x 4 7/8" H (12.7 x 12.4 cm)
- OLID2** Lid for OSCAR2
5" Dia. x 1 5/8" H (12.7 x 4.1 cm)
- OSCAR3** Can
2 qt. (1.9 L)
6" Dia. x 5 7/8" H (15.2 x 14.9 cm)
- OLID3** Lid for OSCAR3
6" Dia. x 1 7/8" H (15.2 x 4.8 cm)



Stainless Steel Milk Cans HOT

- MICH25** 2 1/2 oz. (73.9 mL)
2" Dia. x 2 1/4" H (5.1 x 5.7 cm)
- MICH5** 5 oz. (147.9 mL)
2" Dia. x 3" H (5.1 x 7.6 cm)
- MICH10** 10 oz. (285.7 mL)
3 1/8" Dia. x 4" H (7.9 x 10.2 cm)
- MICH15** 15 oz. (443.6 mL)
2 3/4" Dia. x 5" H (7 x 12.7 cm)



HOT



HOT

PPCN1212

PPCH3R

PPRW1212

PPRN2121

PPCH2N

PPCH1B

Fry and Basket Paper ^{HOT}

FDA-approved, biodegradable, compostable, food-safe paper. Sold in packs of 1000.

Flat 10" Square Paper (25.4 cm)

- PPRW1010 White (not shown)
- PPCN1010 Natural Newspaper (not shown)
- PPCH3N Natural (not shown)
- PPRN1100 Newspaper (not shown)

Flat 12" Square Paper (30.5 cm)

- PPRW1212 White
- PPCN1212 Natural Newspaper
- PPCH2N Natural
- PPRN2121 Newspaper
- PPCH1B Black Checkerboard
- PPCH3R Red Checkerboard

Flat 16" Square Paper (40.6 cm)

- PPRW1616 White
- PPCH4N Natural
- PPCN1616 Natural Newspaper (not shown)
- PPRN1616 Newspaper

Preformed 7" L x 6" W Paper Bags (17.8 x 15.2 cm)

- PPRC76 Natural Newspaper
- PPRN76 Newspaper



HOT

PPRN1616

PPRW1616

PPCH4N



HOT

PPRN76

PPRC76



PPL12 shown with CKNF2 knife

Leaf Cheese Paper

Conjure up a magical experience with your next cheese board or charcuterie. These clever, grease-resistant, food-safe papers are sure to surprise. **Sold in packs of 250.**

- PPL4** 4 ¼" L x 2 ½" W
(10.8 x 6.3 cm)
- PPL7** 7" L x 4 ½" W
(17.8 x 11.4 cm)
- PPL12** 12" L x 7" W
(30.5 x 17.8 cm)

Mini Snack Bags

Disposable and grease-resistant, these simple sacks aren't just for takeout. **Sold in packs of 250.**

Black

- SBB3** 3 ⅜" L x 1 ¾" W x 3 ½" H
(8.6 x 4.4 x 8.9 cm)
- SBB4** 4 ¼" L x 2 ½" W x 3 ¾" H
(10.8 x 6.3 x 9.5 cm)

White

- SBW3** 3 ⅜" L x 1 ¾" W x 3 ½" H
(8.6 x 4.4 x 8.9 cm)
- SBW4** 4 ¼" L x 2 ½" W x 3 ¾" H
(10.8 x 6.3 x 9.5 cm)

Natural

- SBN3** 3 ⅜" L x 1 ¾" W x 3 ½" H
(8.6 x 4.4 x 8.9 cm)
- SBN4** 4 ¼" L x 2 ½" W x 3 ¾" H
(10.8 x 6.3 x 9.5 cm)



SAFE TO BAKE UP TO 350° F
FOR 20 MINUTES



Enamelware

Vintage enamelware is ultra-hot, and this collection is a perfect way to get in on the Americana-inspired craze. Each piece features blue trim on white; a timeless look your customers will love.

- EWM6** Mug
6 oz. (177.4 mL)
2 7/8" Dia. x 2 3/4" H, 3 1/2" L with Handle
(7.3 x 7, 8.9 cm)
- EWB6** Bowl
8 oz. (236.6 mL)
6 1/4" L x 4 7/8" W x 1 1/2" H
(15.9 x 12.4 x 3.8 cm)
- EWM16** Mug
16 oz. (473.2 mL)
3 5/8" Dia. x 4" H, 4 1/2" L with Handle
(9.2 x 10.2, 11.4 cm)
- EWB8** Bowl
16 oz. (473.2 mL)
7 7/8" L x 5 7/8" W x 1 1/2" H
(20 x 14.9 x 3.8 cm)
- EWB10** Bowl
32 oz. (946.4 mL)
10" L x 7 5/8" W x 1 7/8" H
(25.4 x 19.4 x 4.8 cm)



Onyx Galvanized Wide Rim Pans

The days of using a standard aluminum pan for serving are over. You now have options! These dark galvanized pans are perfect for anything from pizza to burritos.

- GTP10** 10" Dia. x 3/8" H (25.4 x 1 cm)
(not shown)
- GTP12** 12" Dia. x 3/8" H (30.5 x 1 cm)
(not shown)
- GTP14** 14" Dia. x 3/8" H (35.6 x 1 cm)
- GTP16** 16" Dia. x 3/8" H (40.6 x 1 cm)
(not shown)
- GTP18** 18" Dia. x 3/8" H (45.7 x 1 cm)
(not shown)

Shown with 4407 and 4406 glass shakers



Square Wide-Rim Pans

Our most popular pizza serving pans have gotten a makeover. These Square Wide-Rim Pizza Pans expertly serve up anything from Sicilian to Detroit-Style pizzas. Made of durable 18-gauge aluminum, these pans can also double as modern serving trays in dining halls and quick serve restaurants.

- STP10** 10" Sq. (25.4 cm)
- STP12** 12" Sq. (30.5 cm)
- STP14** 14" Sq. (35.6 cm)
- STP16** 16" Sq. (40.6 cm)



Shown with
MJ17 mason jar and
HMMJ3 apothecary jar

Stainless Steel Pie Pans

- 918SS** 9 1/8" Top OD x 7 7/8" Top ID
x 6 7/8" Bottom ID x 1" Deep
(23.2 x 20 x 17.5 x 2.5 cm)
- 1187SS** 10 1/8" Top OD x 9" Top ID
x 8 1/8" Bottom ID x 3/4" Deep
(25.7 x 22.9 x 20.6 x 1.9 cm)
- 1300SS** 13 1/8" Top OD x 11 7/8" Top ID
x 10 3/4" Bottom ID x 7/8" Deep
(33.3 x 30.2 x 27.3 x 2.2 cm)

Aluminum Serving Pans USA

- 1188** 10" Top OD x 9" Top ID
x 7 3/4" Bottom ID x 1 1/4" Deep
(25.4 x 22.9 x 19.7 x 3.2 cm)
- 1190** 11 1/8" Top OD x 10" Top ID
x 8 1/4" Bottom ID x 1 5/16" Deep
(28.3 x 25.4 x 21 x 3.3 cm)
- 1200** 11 7/8" Top OD x 10 7/8" Top ID
x 9 1/8" Bottom ID x 1 1/4" Deep
(30.2 x 27.6 x 23.2 x 3.2 cm)
- 1300** 13 1/8" Top OD x 11 7/8" Top ID
x 10 7/8" Bottom ID x 7/8" Deep
(33.3 x 30.2 x 27.6 x 2.2 cm)
(not shown)

Mini Aluminum Pie Pan USA

- 475** 4 3/8" Top OD x 4" Top ID
x 3" Bottom ID x 1" Deep
(11.1 x 10.2 x 7.6 x 2.5 cm)



1188 shown with RSC3 sauce cup

1200

1190 shown with FFCS45 fry cup



475

PETITE DESIGN FOR
VERSATILE USE



Hammered Stainless Steel Tubs

These dishwasher-safe pieces are ideal for serving casual entrées like sandwiches and wraps.

- SHT9** Rectangle, 44 oz. (1.3 L)
9 1/8" L x 6 1/8" W x 2" H
(23.2 x 15.6 x 5.1 cm)
- SHT8** Square, 54 oz. (1.6 L)
8" Sq. x 2" H (20.3 x 5.1 cm)
- SHT17** Rectangle, 54 oz. (1.6 L)
10 1/8" L x 7 1/8" W x 2" H
(25.7 x 18.1 x 5.1 cm)
- SHT10** Square, 90 oz. (2.7 L)
10 1/4" Sq. x 2" H (26 x 5.1 cm)

Stainless Steel Pails and Tubs

A dual satin and mirror finish dresses up this collection.

- STUB63** Tub, 27 oz. (798.5 mL)
6 1/8" Dia. x 3" H (15.6 x 7.6 cm)
- STUB69** Oval Tub, 32 oz. (946.4 mL)
8 3/4" L x 5 5/8" W x 2 1/4" H
(22.2 x 14.2 x 5.7 cm)
- STUB83** Tub, 37 oz. (1.1 L)
8 1/4" Dia. x 3 1/4" H (21 x 8.3 cm)
- STUB93** Tub, 72 oz. (2.1 L)
8 7/8" Dia. x 3 1/4" H (22.5 x 8.3 cm)
- STUB10** Tub, 88 oz. (2.6 L)
9 3/4" Dia. x 3 1/4" H (24.8 x 8.3 cm)
- STUB12** Tub, 95 oz. (2.8 L)
12 1/4" Dia. x 3 3/8" H (31.1 x 7.9 cm)
- STUB87** Pail, 148 oz. (4.4 L)
8 1/4" Dia. x 7 1/8" H (21 x 18.1 cm)
- STUB20** Tub, 25 qt. (24 L)
20" L x 15" W x 11" H
(50.8 x 38.1 x 27.9 cm)



DISHWASHER-SAFE, YET REFINED ENOUGH FOR FORMAL EVENTS

Natural Galvanized

Pails and Tubs HOT

Hand-wash only. Not for use with acidic foods.

- MTUB63** Tub, 27 oz. (798.5 mL)
6 1/8" Dia. x 3" H (15.6 x 7.6 cm)
- MTUB69** Oval Tub, 32 oz. (946.4 mL)
8 3/4" L x 5 1/8" W x 2 1/4" H
(22.2 x 13 x 5.7 cm)
- MTUB83** Tub, 37 oz. (1.1 L)
8" Dia. x 3" H (20.3 x 7.6 cm)
- MTUB93** Tub, 72 oz. (2.1 L)
8 7/8" Dia. x 3 1/4" H (22.5 x 8.3 cm)
- MTUB10** Tub, 88 oz. (2.6 L)
9 3/4" Dia. x 3 1/4" H (24.8 x 8.3 cm)
- MTUB12** Tub, 95 oz. (2.8 L)
11 3/4" Dia. x 3 1/4" H (29.5 x 8.3 cm)
- PTUB87** Pail, 148 oz. (4.4 L)
8 1/4" Dia. x 7 1/8" H (21 x 18.1 cm)
- GPTUB20** Tub, 25 qt. (24 L)
19 5/8" L x 15 1/4" W x 11" H
(49.8 x 38.7 x 27.9 cm)



HOT

Hammered Aluminum Entrée Baskets and Cups

In cool contemporary tones, these personal-sized tubs are perfect for presenting all kinds of entrées and sides. Your customers will love the artisanal aesthetic created by the individually hammered design.

Gold

ASPG Sugar Packet Holder/Sauce Cup
6 oz. (177.4 mL)
3 3/8" L x 2 3/8" W x 2" H
(8.3 x 6 x 5.1 cm)

ABHG46 25 oz. (739.3 mL)
6 1/2" L x 4 3/4" W x 2 1/4" H
(16.5 x 12.1 x 5.7 cm)

ABHG69 48 oz. (1.4 L)
9" L x 6" W x 2 1/4" H
(22.9 x 15.2 x 5.7 cm)

Copper

ASPC Sugar Packet Holder/Sauce Cup
6 oz. (177.4 mL)
3 3/8" L x 2 3/8" W x 2" H
(8.6 x 6 x 5.1 cm)

ABHC46 25 oz. (739.3 mL)
6 1/2" L x 4 3/4" W x 2 1/4" H
(16.5 x 12.1 x 5.7 cm)

ABHC69 48 oz. (1.4 L)
9" L x 6" W x 2 1/4" H
(22.9 x 15.2 x 5.7 cm)

Silver

ASPS Sugar Packet Holder/Sauce Cup
6 oz. (177.4 mL)
3 3/8" L x 2 3/8" W x 2" H
(8.6 x 6 x 5.1 cm)

ABHS46 25 oz. (739.3 mL)
6 1/2" L x 4 3/4" W x 2 1/4" H
(16.5 x 12.1 x 5.7 cm)

ABHS69 48 oz. (1.4 L)
9" L x 6" W x 2 1/4" H
(22.9 x 15.2 x 5.7 cm)

Black

ASPB Sugar Packet Holder/Sauce Cup
6 oz. (177.4 mL)
3 3/8" L x 2 3/8" W x 2" H
(8.6 x 6 x 5.1 cm)

ABHB46 25 oz. (739.3 mL)
6 1/2" L x 4 3/4" W x 2 1/4" H
(16.5 x 12.1 x 5.7 cm)

ABHB69 48 oz. (1.4 L)
9" L x 6" W x 2 1/4" H
(22.9 x 15.2 x 5.7 cm)



OUR POPULAR SQUOUND BOWLS NOW
AVAILABLE IN HAMMERED STAINLESS STEEL



Squound Hammered Bowls

- SBH3** 40 oz. (1.2 L)
7" Dia. x 2 1/8" H (17.8 x 5.4 cm)
- SBH5** 67 oz. (2 L)
9" Dia. x 2 3/4" H (22.9 x 7 cm)
- SBH7** 126 oz. (3.7 L)
11" Dia. x 3" H (27.9 x 7.6 cm)

Squound Hammered Snack Bowls

- SBH325** 3 oz. (100 mL)
3 1/8" Dia. x 1 1/2" H (7.9 x 3.8 cm)
- SBH400** 5 1/2 oz. (200 mL)
3 7/8" Dia. x 1 5/8" H (9.8 x 4.1 cm)
- SBH450** 9 1/2 oz. (300 mL)
4 1/2" Dia. x 2 1/2" H (11.4 x 6.4 cm)
- SBH575** 15 oz. (400 mL)
5 3/4" Dia. x 2 1/2" H (14.6 x 6.4 cm)

Moroccan Hammered Bowls

These one-of-a-kind stainless steel bowls are great serving vessels for global cuisine and practically anything else.

- HB5** 16 oz. (473.2 mL)
5" Dia. x 2" H (12.7 x 5.1 cm)
- HB6** 27 oz. (798.5 mL)
6" Dia. x 2 1/2" H (15.2 x 6.4 cm)
- HB7** 38 oz. (1.1 L)
6 3/4" Dia. x 2 3/4" H (17.1 x 7 cm)





Squound Stainless Steel Bowls

Pair stainless steel with cutting-edge shapes, and you get some of the most contemporary serving bowls on the market.

- SB3** 40 oz. (1.2 L)
7" Dia. x 2 1/8" H (17.8 x 5.4 cm)
- SB5** 67 oz. (2 L)
9" Dia. x 2 3/4" H (22.9 x 7 cm)
- SB7** 126 oz. (3.7 L)
11" Dia. x 3" H (27.9 x 7.6 cm)

Squound Stainless Steel Snack Bowls

- SB325** 3 oz. (100 mL)
3 1/8" Dia. x 1 1/2" H (7.9 x 3.8 cm)
- SB400** 5 1/2 oz. (200 mL)
3 7/8" Dia. x 1 5/8" H (9.8 x 4.1 cm)
- SB450** 9 1/2 oz. (300 mL)
4 1/2" Dia. x 2 1/2" H (11.4 x 6.4 cm)
- SB575** 15 oz. (400 mL)
5 3/4" Dia. x 2 1/2" H (14.6 x 6.4 cm)





PWRB10

PWRB12



PWBB10

PWBB12

Rectangular Poplar Wood Boxes

Farm-to-table never looked so tempting. Use these boxes for baked goods, dry storage and produce for a hand-crafted aesthetic.

Natural

PWRB10 8 1/2" L x 5 3/4" W x 2 3/4" H
(21.6 x 14.6 x 7 cm)

PWRB12 12 3/8" L x 7 1/4" W x 2 3/4" H
(31.4 x 18.4 x 7 cm)

Black

PWBB10 8 1/2" L x 5 3/4" W x 2 3/4" H
(21.6 x 14.6 x 7 cm)

PWBB12 12 3/8" L x 7 1/4" W x 2 3/4" H
(31.4 x 18.4 x 7 cm)



Kraft Bags

Paper bags that you can wash and reuse? It is now a reality with these innovative bread bags. Available in black and khaki colors with contrasting white stitching and foldable rims, each bag is machine washable for extended use.

Black

- KBB5** 5" Dia. x 4" H (12.7 x 10.2 cm)
- KBB7** 7" Dia. x 4" H (17.8 x 10.2 cm)
- KBB9** 9" Dia. x 10 3/8" H (22.9 x 26.4 cm)

Khaki

- KBK5** 5" Dia. x 4" H (12.7 x 10.2 cm)
- KBK7** 7" Dia. x 4" H (17.8 x 10.2 cm)
- KBK9** 9" Dia. x 10 3/8" H (22.9 x 26.4 cm)

Canvas Bags

These cream and gray canvas bags add a rustic feel to table settings. Pre-shrunk and machine-washable.

- TV3** 6 1/2" Dia. x 4 1/8" H (16.5 x 10.5 cm)
- TV4** 7 3/4" Dia. x 4 7/8" H (19.7 x 12.4 cm)
- TV6** 8" L x 6" W x 4" H (20.3 x 15.2 x 10.2 cm)
- TV8** 9 3/4" L x 7" W x 5" H (24.8 x 17.8 x 12.7 cm)
- TV9** 9" Dia. x 10 3/8" H (22.9 x 26.4 cm)





FBC92 shown with
MRS300BL ramekins

FBS591 shown with
MRS300BL ramekins

FFB59

Wrought Iron One-Cone Conical Baskets

- FFB59** One-Cone Basket
5" Dia. x 9" H (12.7 x 22.9 cm)
- FBS591** One-Cone Basket with
One Ramekin Holder
(1) 3 oz. (88.7 mL) Ramekin included
5" Dia. x 9" H (12.7 x 22.9 cm)
- FBC92** One-Cone Basket with
Two Ramekin Holders
(2) 3 oz. (88.7 mL) Ramekins included
5" Dia. x 9" H (12.7 x 22.9 cm)

Flat Coil Wrought Iron Conical Baskets

- FCD1** 5" Dia. x 6 ¾" H
(12.7 x 17.1 cm)
- FCD2** 7" Dia. x 6" H
(17.8 x 15.2 cm)

Flat Coil Wrought Iron Slanted Conical Basket

- FWB4** 4 ½" Dia. x 7 ½" H
(11.4 x 19 cm)

Stainless Steel Conical Baskets

- SS59** One-Cone Basket
5" Dia. x 9" H (12.7 x 22.9 cm)
- SS92** One-Cone Basket with
Two Ramekin Holders
(2) 3 oz. (88.7 mL) Ramekins included
5" Dia. x 9" H (12.7 x 22.9 cm)



FCD2

FCD1



FWB4



SS92 shown with
MRS300BL ramekins

SS59

Two-Tier Wrought Iron Basket

This seemingly hand-twisted basket would look as comfortable in an art museum as it will in your dining room.

TTDB2 Two-Tier Basket
13" Top Dia. x 15" Bottom Dia. x 19 5/8" H
(33 x 38.1 x 49.9 cm)

Square Fry Cone Holders and Cardboard Cones

SQFBSS Stainless Steel
2 1/2" Sq. Top x 3 5/8" Round Base x 5 1/4" H
(6.4 x 9.2 x 13.3 cm)

SQFBBL Black 
2 1/2" Sq. Top x 3 5/8" Round Base x 5 1/4" H
(6.4 x 9.2 x 13.3 cm)

Square Cardboard Cones

SQFBCN10 10 oz. (295.7 mL)
4" Tapered Opening x 7 1/4" H
(10.2 x 18.4 cm)
Pack of 100

SQFBCN 15 oz. (443.6 mL)
4 3/4" Tapered Opening x 10 3/4" H
(12.1 x 27.3 cm)
Pack of 100

Stainless Steel Conical Snack Holder

A smooth satin finish and sophisticated shape add a futuristic twist to this conical fry holder.

SSFC7 Standard
4 1/2" Dia. x 7" H
(11.4 x 17.8 cm)



SSFC7



TTDB2



PREFOLDED
CONES FEATURE
A FOLDOUT
CONDIMENT
POCKET

SQFBBL shown
with SQFBCN cone

SQFBSS shown with
SQFBCN10 cone



Mini Fry Baskets HOT

Everyone loves the classic design and easy storage of our fry baskets. They're great for serving up any side, not just fried foods.

Stainless Steel

FRYT433 Rectangular
4 1/8" L x 3 3/8" W x 3" H
with 3 1/2" Handle
(10.5 x 8.6 x 7.6, 8.9 cm)

FRYS443 Square
4" Sq. x 3" H
with 3 1/2" Handle
(10.2 x 7.6, 8.9 cm)

Black

FRYB433 Rectangular
4 1/8" L x 3 3/8" W x 3" H
with 3 1/2" Handle
(10.5 x 8.6 x 7.6, 8.9 cm)

FRYB443 Square
4" Sq. x 3" H
with 3 1/2" Handle
(10.2 x 7.6, 8.9 cm)



Round Stainless Steel Fry Basket

FRYR375 Round
3 1/2" Dia. x 2 3/4" H
with 4" Handle
(8.9 x 7, 10.2 cm)





Stainless Steel Fry Baskets

MSQBSKT Square
5" Sq. x 3" H
with 3 ¾" Handle
(12.7 x 7.6, 9.5 cm)

MFRYBSKT Rectangular
5" L x 4" W x 3" H
with 3 ¾" Handle
(12.7 x 10.2 x 7.6, 9.5 cm)

Stainless Steel Mini Snack Baskets

Our popular fry baskets are now available without handles.

FBSR43 Rectangular
4 ½" L x 3 ¾" W x 3" H
(10.5 x 8.6 x 7.6 cm)

FBSS44 Square
4" Sq. x 3" H
(10.2 x 7.6 cm)





Laser Cut Fry Baskets

Sleek, stylish and contemporary, these baskets offer a modern twist on the traditional fry basket. Each item is expertly crafted and laser cut from stainless steel to provide a precise design with every piece. Dishwasher-safe gold finish. Color may vary slightly.

Silver

- LFRY44** Square
4" Sq. x 3" H (10.2 x 7.6 cm)
- LFRY43** Rectangle
4 1/8" L x 3 3/8" W x 3" H
(10.5 x 8.6 x 7.6 cm)
- LFRY55** Square
5" Sq. x 3" H (12.7 x 7.6 cm)
- LFRY54** Rectangle
5" L x 4" W x 3" H (12.7 x 10.2 x 7.6 cm)
- LPLT10** Rectangular Platter
10" L x 7" W x 1" H (25.4 x 17.8 x 2.5 cm)

Gold

- LFRYG44** Square
4" Sq. x 3" H (10.2 x 7.6 cm)
- LFRYG43** Rectangle
4 1/8" L x 3 3/8" W x 3" H
(10.5 x 8.6 x 7.6 cm)
- LFRYG55** Square
5" Sq. x 3" H (12.7 x 7.6 cm)
- LFRYG54** Rectangle
5" L x 4" W x 3" H (12.7 x 10.2 x 7.6 cm)
- LPLTG10** Rectangular Platter
10" L x 7" W x 1" H (25.4 x 17.8 x 2.5 cm)



MRECBSKT shown with
PNS24 S&P shakers,
SSP35 pail and MB1
sauce cup

Rectangular Fry Basket

MRECBSKT 9 1/2" L x 6" W x 1 1/2" H
with 4" Handle
(24.1 x 15.2 x 3.8, 10.2 cm)

Rectangular Grid Baskets

Small

 RMB95B Black
9" L x 6" W x 2 1/2" H
(22.9 x 15.2 x 6.4 cm)

 RMB59C Chrome
9" L x 6" W x 2 1/2" H
(22.9 x 15.2 x 6.4 cm)

SSRT962 Stainless Steel
9" L x 6" W x 2 1/2" H
(22.9 x 15.2 x 6.4 cm)

Large

 GCRB2613 Black
13" L x 6" W x 2 1/2" H
(33 x 15.2 x 6.4 cm)

 GCRC1362 Chrome
13" L x 6" W x 2 1/2" H
(33 x 15.2 x 6.4 cm)

GCSS6132 Stainless Steel
13" L x 6" W x 2 1/2" H
(33 x 15.2 x 6.4 cm)



RMB59C

RMB95B shown with
FFC337 fry cup

SSRT962



GCRB2613

GCSS6132

GCRC1362 shown with
FRYR375 fry basket and
MRF350W ramekin

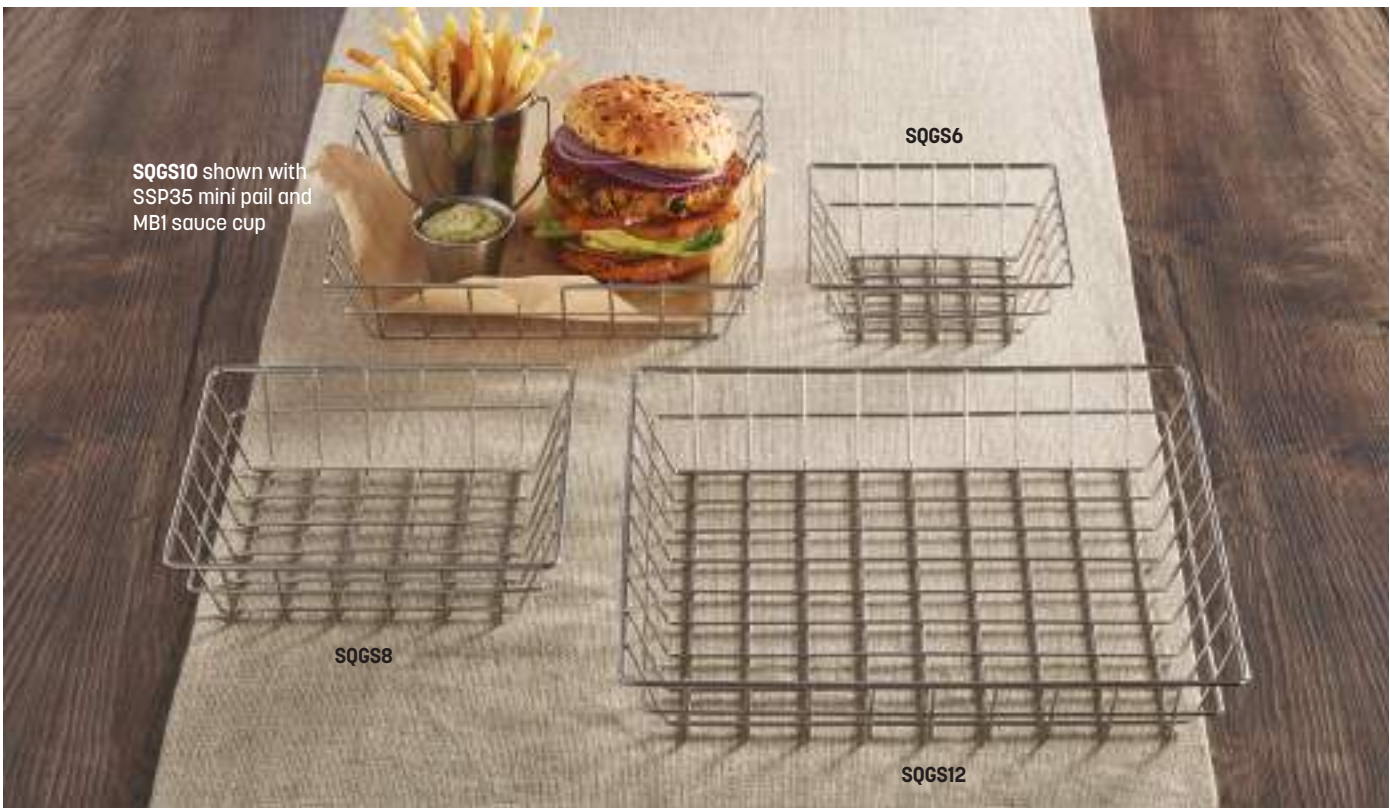

SQGS10 shown with SSP35 mini pail and MB1 sauce cup

SQGS6

SQGS8

SQGS12



SQGB10

SQGB12

SQGB8

SQGB6

Square Grid Baskets

The classic, squared. Our popular wire baskets now come in multiple square sizes. Think beyond the plate for burgers and fries, sandwiches or appetizers.

Stainless Steel

- SQGS6** 6" Sq. x 2" H
(15.2 x 5.1 cm)
- SQGS8** 8" Sq. x 2" H
(20.3 x 5.1 cm)
- SQGS10** 10" Sq. x 2" H
(25.4 x 5.1 cm)
- SQGS12** 12" Sq. x 2" H
(30.4 x 5.1 cm)

Black

- SQGB6** 6" Sq. x 2" H
(15.2 x 5.1 cm)
- SQGB8** 8" Sq. x 2" H
(20.3 x 5.1 cm)
- SQGB10** 10" Sq. x 2" H
(25.4 x 5.1 cm)
- SQGB12** 12" Sq. x 2" H
(30.4 x 5.1 cm)



Round Grid Baskets

In stainless steel or black, these grid-bottomed baskets can be dressed to look retro or futuristic.

Stainless Steel

WISS8 8" Dia. x 2" H
(20.3 x 5.1 cm)

WISS10 10" Dia. x 2" H
(25.4 x 5.1 cm)

WISS12 12" Dia. x 2" H
(30.5 x 5.1 cm)

Black

WIB80 8" Dia. x 2" H
(20.3 x 5.1 cm)

WIB100 10" Dia. x 2" H
(25.4 x 5.1 cm)

WIB120 12" Dia. x 2" H
(30.5 x 5.1 cm)





GOVB69

GOVB811 shown with PPRN2121 fry paper and HAMSC25 sauce cup

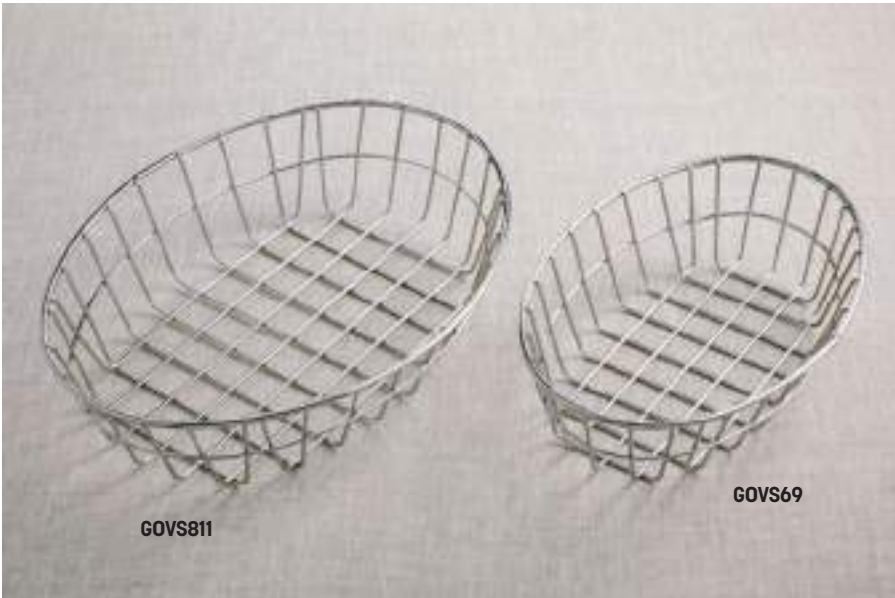

GOVS811

GOVS69

Oblong Grid Baskets

In your choice of black or stainless steel, these stylish baskets are perfect for serving casual entrées and appetizers with panache.

Black

GOVB69 9" L x 6" W x 2 1/2" H
(22.9 x 15.2 x 6.4 cm)

GOVB811 11" L x 8" W x 2 1/2" H
(27.9 x 20.3 x 6.4 cm)

Stainless Steel

GOVS69 9" L x 6" W x 2 1/2" H
(22.9 x 15.2 x 6.4 cm)

GOVS811 11" L x 8" W x 2 1/2" H
(27.9 x 20.3 x 6.4 cm)



BZZ95B

BZZ59C



ROC1362

ROB2613 shown with
FFB59 conical basket

Zorro Baskets

Small

BZZ95B Black
9" L x 6" W x 2 1/2" H
(22.9 x 15.2 x 6.4 cm)

BZZ59C Chrome
9" L x 6" W x 2 1/2" H
(22.9 x 15.2 x 6.4 cm)

Large

ROB2613 Black
13" L x 6" W x 2 1/2" H
(33 x 15.2 x 6.4 cm)

ROC1362 Chrome
13" L x 6" W x 2 1/2" H
(33 x 15.2 x 6.4 cm)

Loop-D-Loop Baskets

Small

EBB59B Black
9" L x 6" W x 2 1/2" H
(22.9 x 15.2 x 6.4 cm)

EBB95C Chrome
9" L x 6" W x 2 1/2" H
(22.9 x 15.2 x 6.4 cm)

Large

LDLB2613 Black
13" L x 6" W x 2 1/2" H
(33 x 15.2 x 6.4 cm)

LDLC1362 Chrome
13" L x 6" W x 2 1/2" H
(33 x 15.2 x 6.4 cm)



EBB59B

EBB95C



LDLB2613

LDLC1362



BLLB94

BLSB93

BLSB80

BLLB81



OSC9

OLB9

IRONWORKS™ BASKETS

Whether you're serving breads, sandwiches or snacks, our Ironworks Collection twists hearty wrought iron and steel into artisanal showstoppers.

Round Wrought Iron Bread Baskets

BLLB81 Leaf, 8" Dia. x 3" H
(20.3 x 7.6 cm)

BLLB94 Leaf, 9" Dia. x 3 5/8" H
(22.9 x 9.2 cm)

BLSB80 Scroll, 8" Dia. x 3" H
(20.3 x 7.6 cm)

BLSB93 Scroll, 9" Dia. x 3 5/8" H
(22.9 x 9.2 cm)

Oval Wrought Iron Bread Baskets

OSC9 Scroll, 6 3/4" L x 9" W
(17.1 x 22.9 cm)

OLB9 Leaf, 6 3/4" L x 9" W
(17.1 x 22.9 cm)



Shown with PRSD3 sauce cup



FRUC16

FRUB18

Shown with
DXP4 S&P shakers

BIRDNEST BASKETS

Our Birdnest Baskets feature a lightweight yet sturdy construction. Choose from a variety of shapes and styles in black or chrome.

Round Baskets

FRUB9 Black, 7" Dia. x 5" H
(17.8 x 12.7 cm)

FRUC7 Chrome, 7" Dia. x 5" H
(17.8 x 12.7 cm)

Disposable Liner

WBCLINER PET Liner
for 7" Dia. baskets

Oval Baskets

FRUB18 Black, 9" L x 6" W x 3" H
(22.9 x 15.2 x 7.6 cm)

FRUC16 Chrome, 9" L x 6" W x 3" H
(22.9 x 15.2 x 7.6 cm)

Square Baskets/Risers

BNRB64B Black, 6" Sq. Top
x 4" Sq. Bottom x 4" H
(15.2 x 10.2 x 10.2 cm)

BNRB86B Black, 8" Sq. Top
x 6" Sq. Bottom x 4" H
(20.3 x 15.2 x 10.2 cm)

BNRB46C Chrome, 6" Sq. Top
x 4" Sq. Bottom x 4" H
(15.2 x 10.2 x 10.2 cm)

BNRB68C Chrome, 8" Sq. Top
x 6" Sq. Bottom x 4" H
(20.3 x 15.2 x 10.2 cm)



BNRB68C

BNRB86B

BNRB64B

BNRB46C



BSKB80 shown with
MRS200BL ramekin

BSKC08



BSKB96

BSKC69 shown with
MRS200W ramekins

Round Wire Baskets with Ramekin Holders  

BSKB80 Black
8" Dia. x 3 3/4" H
(20.3 x 9.5 cm)

BSKC08 Chrome
8" Dia. x 3 3/4" H
(20.3 x 9.5 cm)

Oblong Wire Baskets with Ramekin Holders  

BSKB96 Black
9" L x 6" W x 4" H
(22.9 x 15.2 x 10.2 cm)

BSKC69 Chrome
9" L x 6" W x 4" H
(22.9 x 15.2 x 10.2 cm)

HOT

BSKB811 shown with
MRS200BL ramekins

BSKC118

Oval Wire Baskets with Ramekin Holders-Mesh Bottom HOT

With stylishly retro curves and your choice of finish, these durable baskets are great for sandwich and entrée service.

BSKB811 Black
 11" L x 8" W x 3 1/4" H
 (27.9 x 20.3 x 8.3 cm)

BSKC118 Chrome
 11" L x 8" W x 3 1/4" H
 (27.9 x 20.3 x 8.3 cm)

Smooth Ramekins

MRS200W White, 2 oz. (59.1 mL)

MRS200BL Black, 2 oz. (59.1 mL)

Fluted Ramekins

MRF250W White, 2 oz. (59.1 mL)

MRF250BL Black, 2 oz. (59.1 mL)

Onion Ring Spindles

Take your onion ring and bagel presentation to new heights with these stainless steel spindles. Fits round and oval baskets (sold separately).

ORHC1 Round Base
 5 1/4" Dia. x 9" H
 (13.3 x 22.9 cm)

ORH02 Oval Base
 6 1/4" L x 4" W x 9" H
 (15.9 x 10.2 x 22.9 cm)

ORHC1 shown with
 BSKC08 basket and
 MRF250BL ramekins

ORH02 shown with
 BSKC69 basket and
 MRF250BL ramekins

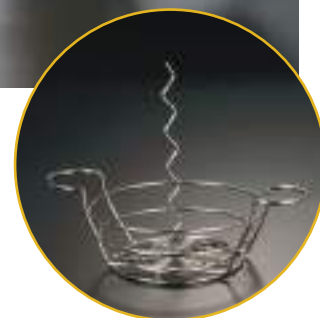



WBBR80 shown with
RGJ4 glass jar and
PPCH4N natural paper

WBBV90

Black Wire Baskets

These essential baskets set the stage for entrées and appetizers alike. Elegant, sleek and absolutely eye-catching.

WBBV90 Oval
9" L x 6" W x 2 ¾" H
(22.9 x 15.2 x 7 cm)

WBBR80 Round
8" Dia. x 2 ¾" H
(20.3 x 7 cm)

Bronze Wire Baskets

A beautiful bronze finish on an attractive wire design, perfect for presenting rolls, breads and biscuits.

Round

WBBS 5" Dia. x 3 ⅛" H
(12.7 x 7.9 cm)

WBBM 7" Dia. x 4 ¼" H
(17.8 x 10.8 cm)

Oval

WBB9 9" L x 6" W x 2 ¼" H
(22.9 x 15.2 x 5.7 cm)

WBB11 11" L x 8" W x 2 ½" H
(27.9 x 20.3 x 6.4 cm)



WBBM shown with
PPCH2N natural paper

WBBS



WBB11

WBB9

Black Mesh Bottom Baskets

These simple, functional wrought iron baskets come in your choice of size and design.

- SSB28** Straight-Sided Round
8" Dia. x 2 1/2" H
(20.3 x 6.4 cm)
- SSB96** Straight-Sided Oval
9" L x 6" W x 2 1/2" H
(22.9 x 15.2 x 6.4 cm)
- WSB82** Wavy-Sided Round
8" Dia. x 2 1/2" H
(20.3 x 6.4 cm)
- WSB69** Wavy-Sided Oval
9" L x 6" W x 2 1/2" H
(22.9 x 15.2 x 6.4 cm)

Chix Wire Baskets

In black or chrome, these rustic baskets bring homey authenticity to your presentation.

- WIR4** Black Oval
9 1/2" L x 6 1/2" W x 2 1/2" H
(24.1 x 16.5 x 6.4 cm)
- WIR3** Chrome Oval
9 1/2" L x 6 1/2" W x 2 1/2" H
(24.1 x 16.5 x 6.4 cm)

Go-Go Baskets

- WCW69** Silver Oval
9" L x 6" W x 3" H
(22.9 x 15.2 x 7.6 cm)
- WCW81** Silver Round
8" Dia. x 2 7/8" H
(20.3 x 7.3 cm)
- WBW96** Black Oval
9" L x 6" W x 3" H
(22.9 x 15.2 x 7.6 cm)
- WBW80** Black Round
8" Dia. x 2 7/8" H
(20.3 x 7.3 cm)

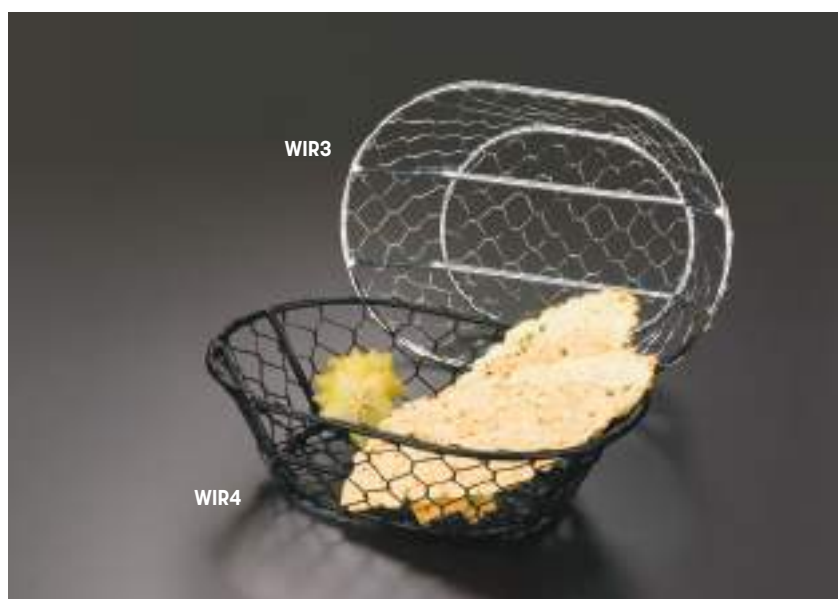



OBS913

BSS11

BSS7

OBS69

BSS8

OBS58



FRUB12

FRUC10

Stainless Steel Baskets

Available in oval and round shapes and three different sizes.

Oval

OBS58 7 7/8" L x 5 5/8" W x 3" H
(20 x 14.3 x 7.6 cm)

OBS69 9 1/8" L x 7" W x 3" H
(23.2 x 17.8 x 7.6 cm)

OBS913 13 3/8" L x 9 3/8" W x 4 1/2" H
(34 x 23.8 x 11.4 cm)

Round

BSS7 6 5/8" Dia. x 2 3/4" H
(16.8 x 7 cm)

BSS8 8" Dia. x 2 7/8" H
(20.3 x 7.3 cm)

BSS11 11" Dia. x 4 1/4" H
(27.9 x 11 cm)

Round Thatch Baskets

These unique baskets are ideal for serving baked goods in an intimate setting, or even for a memorable sandwich presentation.

FRUB12 Black
8" Dia. x 3 5/8" H
(20.3 x 9.2 cm)

FRUC10 Chrome
8" Dia. x 3 5/8" H
(20.3 x 9.2 cm)

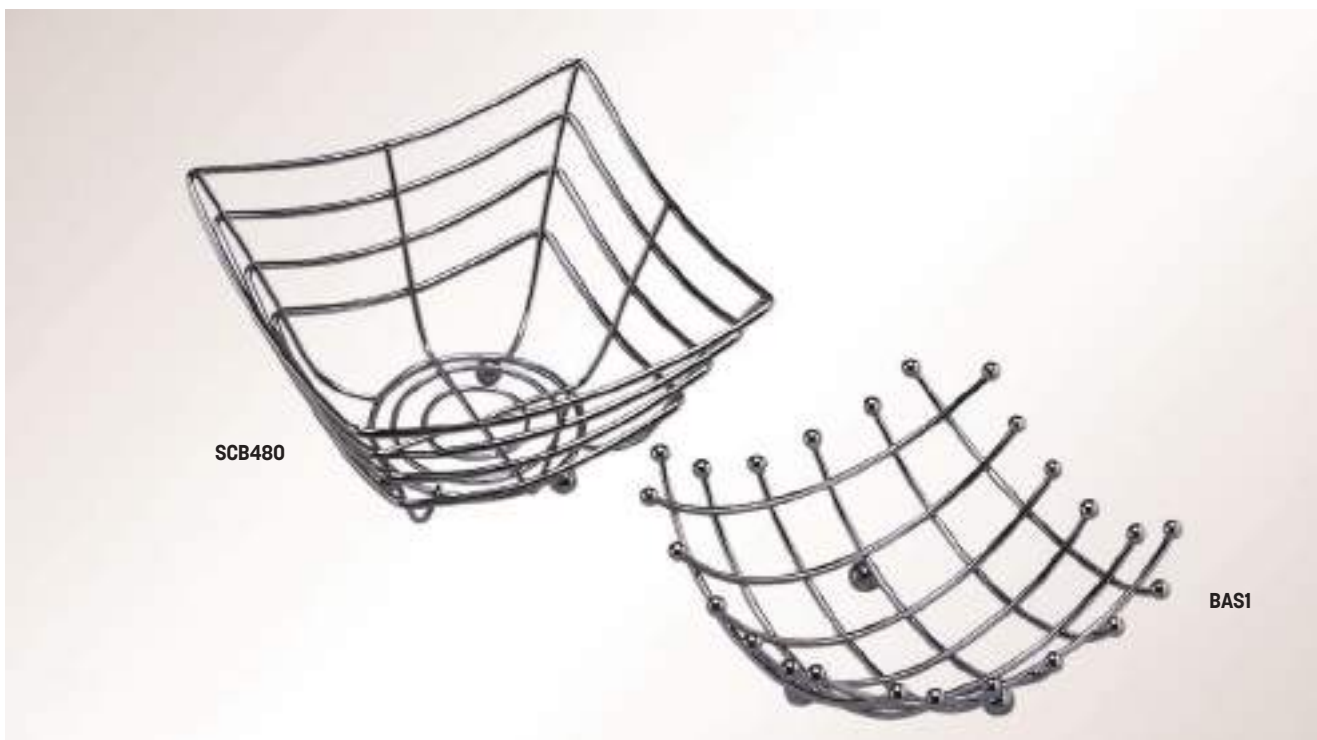

Space/Time Continuum Chrome Baskets

Retro-futurism is timeless, and these chic baskets are proof.

SCB480 Square Web
8 1/4" Sq. x 4 1/2" H (21 x 11.4 cm)

BAS1 Checker
8" Sq. x 2 3/4" H (20.3 x 7 cm)

Round Wire Baskets

Available in chrome or black wire. A plastic liner is also available.

BWB750 Black
7" Dia. x 5" H (17.8 x 13 cm)

WBC705 Chrome
7" Dia. x 5" H (17.8 x 13 cm)



Disposable Liner

WBCLINER PET Liner for 7" Dia. Baskets
(not shown)

Shown with GLADT6,
3307 and BEE319 shakers



SCAW7



USE TO CREATE A FRESH
CONDIMENT STATION



FITS AN ASSORTMENT
OF SHAKERS DUE
TO BUILT-IN LEDGE

Loft Collection Acacia Wood Shaker Caddy

Stylishly bring the condiments to the table with this beautifully designed caddy from the Loft Collection. Made of intricately grained Acacia wood, this caddy includes three holders for a trio of shakers or loose condiments. The smart inset design allows for a solid fit for most 6 to 12 oz. shakers. Knockdown handle also allows for smart shipping and storage.

SCAW7 7" L x 6 1/2" W x 8 5/8" H
(17.8 x 16.5 x 21.9 cm)
Fits Most 6 oz. (177.4 mL) to
12 oz. (354.9 mL) Shakers



CCAW9

CCAW8

CCAW7

Loft Collection Condiment Caddies

Rustic beauty just radiates from these acacia wood caddies. Designed to organize tabletop essentials like condiments, spices and rolled flatware, each caddy conveniently includes a notched handle for table number cards.

CCAW7 7 1/4" Dia. x 10" H
(18.4 x 25.4 cm)

CCAW8 8 3/8" Dia. x 10" H
(21.3 x 25.4 cm)

CCAW9 9 1/8" L x 7 1/8" W x 10" H
(23.2 x 18.1 x 25.4 cm)



CSM2 shown with OWP13 olive wood peel

CSM3

CSM40 shown with 4406 and GLADT6 shakers

Jumbo Stainless Steel Soup Cans

Whether you use them as risers or condiment holders, these rustic cans offer versatile solutions with a memorable twist.

- CSM40** 40 oz. (1.2 L)
6 ¼" Dia. x 3" H (15.9 x 7.6 cm)
- CSM2** 2 qt. (1.9 L)
5 ¼" Dia. x 6" H (13.3 x 15.2 cm)
- CSM3** 3 ¼ qt. (3.1 L)
6 ¼" Dia. x 7" H (15.9 x 17.8 cm)

Contemporary Condiment Racks

These brushed stainless steel and black condiment holders feature a laser-cut design for a modern, upscale look.

Stainless Steel

- SCH6** 6 ¼" Dia. x 9 ¼" H
(15.9 x 23.5 cm)
- SCH7** 7 ¾" Dia. x 9 ½" H
(19.7 x 24.1 cm)
- SCH8** 8" L x 5 ⅞" W x 9 ½" H
(20.3 x 14.9 x 24.1 cm)

Black

- SCHB6** 6 ¼" Dia x 9 ¼" H
(15.9 x 23.5 cm)
- SCHB7** 7 ¾" Dia x 9 ½" H
(19.7 x 24.1 cm)
- SCHB8** 8" L x 5 ⅞" W x 9 ½" H
(20.3 x 14.9 x 24.1 cm)



SCH7

SCH6

SCH8



SCHB8

SCHB7

SCHB6

CRL86 shown with BHM2 S&P shakers and BEE606 shaker



FLAT-BACK DESIGN FOR PLACEMENT AGAINST A WALL



CRS68

Semi-Round Wrought Iron Condiment Racks

- CRL86** Leaf
8 ¼" L x 6 ¼" W x 9" H
(21 x 15.9 x 22.9 cm)
- CRS68** Scroll
8 ¼" L x 6 ¼" W x 9" H
(21 x 15.9 x 22.9 cm)

Wrought Iron Condiment Racks

Leaf Design

- LDCC16** 6 ¼" Dia. x 9" H
(15.9 x 22.9 cm)
- LDCC17** 7 ½" Dia. x 9" H
(19.1 x 22.9 cm)
- LDCC18** 7 ¾" Dia. x 9" H
(19.7 x 22.9 cm)

Scroll Design

- WBCC6** 6 ¼" Dia. x 9" H
(15.9 x 22.9 cm)
- WBCC7** 7 ½" Dia. x 9" H
(19.1 x 22.9 cm)
- WBCC8** 7 ¾" Dia. x 9" H
(19.7 x 22.9 cm)

102

LDCC17 shown with BHM2 S&P shakers



LDCC18

LDCC16

WBCC6

WBCC7 shown with GLA316 shaker and BHM2 S&P shakers

WBCC8 shown with BEE606 shaker



HOT

ALL THREE DESIGNS FEATURE
CENTER-SLOTTED HANDLES

FWC68 shown with
BHM2 S&P shakers



FWC89 shown with
3309 shaker



FWC69



**Flat Coil Wrought Iron
Condiment Racks**



FWC69 6" Dia. x 9 1/2" H
(15.2 x 24.1 cm)

FWC89 7 7/8" Dia. x 9 1/8" H
(20 x 23.2 cm)

FWC68 8" L x 5 7/8" W x 9 1/4" H
(20.3 x 14.9 x 23.5 cm)

**Birdnest Semi-Round
Condiment Racks**



SRBNB1 Black
5 5/8" L x 8" W x 9 1/8" H
(14.3 x 20.3 x 23.2 cm)

SRBNC2 Chrome
5 5/8" L x 8" W x 9 1/8" H
(14.3 x 20.3 x 23.2 cm)



SRBNB1

SRBNC2



RBNC26

RBNB16



RBNB17 shown with BEE319 shaker and PNS13 S&P shakers

RBNC27

Birdnest Condiment Racks

Small

RBNB16 Black
6" Dia. x 9 1/8" H
(15.2 x 23.2 cm)

RBNC26 Chrome
6" Dia. x 9 1/8" H
(15.2 x 23.2 cm)

Large

RBNB17 Black
7 3/4" Dia. x 9 1/8" H
(19.7 x 23.2 cm)

RBNC27 Chrome
7 3/4" Dia. x 9 1/8" H
(19.7 x 23.2 cm)



WSPR2B

WSPR3C shown with PNS24 S&P shakers

Salt & Pepper Racks

In black or chrome, each rack features a slot on top to hold order numbers or menus.

WSPR2B Black
5 3/4" L x 2 1/4" W x 12" H
(14.6 x 5.7 x 30.5 cm)

WSPR3C Chrome
5 3/4" L x 2 1/4" W x 12" H
(14.6 x 5.7 x 30.5 cm)

Rectangular Shopping Baskets

Keep condiments and napkins handy with these charming double-handed baskets.

RBHB975 Black
9" L x 7" W x 5" H
(22.9 x 17.8 x 12.7 cm)

RBHC759 Chrome
9" L x 7" W x 5" H
(22.9 x 17.8 x 12.7 cm)



Rectangular Condiment Racks

Though we designed them for condiments, these racks double as stages for sandwiches.

BWC9 9" L x 6" W x 3 1/2" H
(22.9 x 15.2 x 8.9 cm)

BWC12 12 3/4" L x 4 3/8" W x 3 1/2" H
(32.4 x 11.1 x 8.9 cm)



Galvanized Condiment Caddy

We made these metallic caddies extra deep to make topper-proof transport a cinch.

MTUB7 7" L x 5 3/4" W x 4" H
(17.8 x 14.6 x 10.2 cm)



COMPLETE THE LOOK WITH OUR GALVANIZED TUBS ON PG. 80



Glass Carafes

With smaller sizes for individual servings of beverages or soups, and larger sizes for shared drinks, these elegantly curved carafes are a stylish addition to any brunch or dinner service.

Multi-Serving

- GC36** 36 oz., 34 oz. to Shoulder (1.1 L, 1 L)
4" Dia. x 9 1/2" H (10.2 x 24.1 cm)
- GC34** 34 oz., 16 oz. to Shoulder (1 L, 473.2 mL)
4" Dia. x 9 1/2" H (10.2 x 24.1 cm)

Single-Serving

- GC12** 12 oz., 10.5 oz. to Shoulder (354.9 mL, 310.5 mL)
3 1/4" Dia. x 4 3/4" H (8.2 x 12 cm)
- GC8** 8 oz., 3 oz. to Shoulder (236.6 mL, 88.7 mL)
3" Dia. x 4 3/4" H (7.6 x 12 cm)



Glass Water Bottles and Stoppers

In-house water filtration is in, and these elegant pieces are the perfect accompaniment to the trend. Mix and match two styles of carafes and three styles of stoppers to elevate your H₂O. Stopper sold separately.

Glass Water Bottles

- GCD28** Diamond
29 oz., 28 oz. to Shoulder (0.9 L, 0.8 L)
3 1/8" Dia. x 10 1/4" H (7.9 x 26 cm)
- GCH28** Pebbled
29 oz., 28 oz. to Shoulder (0.9 L, 0.8 L)
3 1/8" Dia. x 10 1/4" H (7.9 x 26 cm)

Glass and Silicone Bottle Stoppers

- GSB2** Blue Marble
1 3/4" Dia. x 2 3/4" H (4.4 x 7 cm)
- GSC2** Clear
1 3/4" Dia. x 2 3/4" H (4.4 x 7 cm)
- GSF2** Frosted
1 3/4" Dia. x 2 3/4" H (4.4 x 7 cm)

Hinged Acrylic Water Bottles

Our original take on a popular style, these gasketed bottles are designed to keep out contaminants.

WBC34 34 oz. (1 L)
4 1/8" Dia. x 11 5/8" H (10.5 x 29.5 cm)

WBC36 36 oz. (1.1 L)
3 3/8" Dia. x 11 1/8" H (8.6 x 28.3 cm)

Clear Acrylic Water Bottles

In a quartet of distinct styles, these one-liter acrylic bottles make even simple beverages photogenic. Cap included.

WB32 Clear
34 oz. (1 L)
3 1/2" Dia. x 11 1/4" H (8.9 x 28.6 cm)

WB33 Fluted
34 oz. (1 L)
3 1/2" Dia. x 11 1/4" H (8.9 x 28.6 cm)

WB34 Pebbled
34 oz. (1 L)
3 1/2" Dia. x 11 1/4" H (8.9 x 28.6 cm)

WB35 Diamond
34 oz. (1 L)
3 1/2" Dia. x 11 1/4" H (8.9 x 28.6 cm)

WBCAP Replacement Cap
1 5/8" Dia. x 1" H (4.1 x 2.5 cm)



TURN CLEAR ACRYLIC WATER BOTTLES INTO A JUMBO MIXER BOTTLE WITH A STAINLESS STEEL POURER ON PG. 348 OR A SALAD DRESSING POURER ON PG. 158





Pebbled Acrylic Water Bottle

Inspired by our pebbled glass water bottle, this piece is made from plastic for extra durability. Cap included.

WBP34 34 oz. (1 L)
3 7/8" Dia. x 11 5/8" H
(8.9 x 29.5 cm)

WBPCAP Replacement Cap
2 1/4" Dia. x 5/8" H
(5.7 x 1.6 cm)

Clear Acrylic Water Carafes with Cup

Durable and designed with ease in mind, these cup-carafe combos are crafted for daily use.

WC40 40 oz. (1.2 L)
3 1/2" Dia. x 10" H
(8.9 x 25.4 cm)



Freshly Squeezed

CUP AND CARAFE FIT TOGETHER FOR EASY TRANSPORT AND STORAGE

WC40



Bell Pitchers

Available in stainless steel mirror finish.

Stainless Steel

- WP68** 68 oz. (2 L)
5" Dia. x 8 1/4" H
8 1/4" W with Handle
(12.7 x 21, 21 cm)
- WP100** 100 oz. (3 L)
5 1/4" Dia. x 9" H
9 3/4" W with Handle
(13.3 x 22.9, 24.8 cm)
- BPG67** 68 oz. (2 L)
5" Dia. x 8 1/2" H
8 1/4" W with Handle
(12.7 x 21.6, 21 cm)
Includes Ice Guard
- BPG101** 100 oz. (3 L)
5" Dia. x 9 1/4" H
9 3/4" W with Handle
(12.7 x 23.5, 24.8 cm)
Includes Ice Guard





Long Neck Bell Pitchers

Available in a hammered or brushed stainless steel finish.

Single-Wall

BWP84 Satin Finish
84 oz. (2.5 L)
5" Dia. x 9 1/4" H, 8 3/4" W with Handle
(12.7 x 23.5, 22.2 cm)
(Not Shown, Includes Ice Guard)

BWPH84 Hammered Finish
84 oz. (2.5 L)
5" Dia. x 9 1/4" H, 8 3/4" W with Handle
(12.7 x 23.5, 22.2 cm)
(Not Shown, Includes Ice Guard)

Double-Wall

SDWP64 Satin Finish
64 oz. (1.9 L)
5" Dia. x 10 3/4" H, 8 3/4" W with Handle
(12.7 x 27.3, 22.2 cm)

DWPH64 Hammered Finish
64 oz. (1.9 L)
5" Dia. x 10 3/4" H, 8 3/4" W with Handle
(12.7 x 27.3, 22.2 cm)

Gold Long Neck Bell Pitchers

Featuring beautiful hammered and satin finishes, these gold pitchers are très fashionable.

Single-Wall

BWPG84 Satin Finish
84 oz. (2.5 L)
5" Dia. x 9 1/4" H, 8 3/4" W with Handle
(12.7 x 23.5, 22.2 cm)

BWPHG84 Hammered Finish
84 oz. (2.5 L)
5" Dia. x 9 1/4" H, 8 3/4" W with Handle
(12.7 x 23.5, 22.2 cm)





Double-Wall Bell Pitchers

These double-walled pitchers are cleverly crafted to reduce condensation and drippage.

Mirror Finish

DWP44 44 oz. (1.3 L)
4 ½" Dia. x 8 ⅛" H, 8 ½" W with Handle
(11.4 x 20.6, 21.6 cm)

DWP64 64 oz. (1.9 L)
5" Dia. x 9" H, 10" W with Handle
(12.7 x 22.9, 25.4 cm)
(not shown)

Hammered Finish

HMWP44 44 oz. (1.3 L)
4 ½" Dia. x 8 ⅛" H, 8 ½" W with Handle
(11.4 x 20.6, 21.6 cm)

HMWP64 64 oz. (1.9 L)
5" Dia. x 9" H, 10" W with Handle
(12.7 x 22.9, 25.4 cm)
(not shown)

Satin Finish

DWPS44 44 oz. (1.3 L)
4 ½" Dia. x 8 ⅛" H, 8 ½" W with Handle
(11.4 x 20.6, 21.6 cm)

DWPS64 64 oz. (1.9 L)
5" Dia. x 9" H, 10" W with Handle
(12.7 x 22.9, 25.4 cm)
(not shown)



Hammered Bell Water Pitchers

Add a touch of artistry to your cold beverage service with these hammered stainless steel pitchers. Perfect for water, iced tea or lemonade.

HMWP85 68 oz. (2 L)
5" Dia. x 8 ¼" H, 8 ¼" W with Handle
(12.7 x 21, 21 cm)

HMWP97 100 oz. (3 L)
6" Dia. x 9" H, 9 ¾" W with Handle
(15.2 x 22.9, 24.8 cm)



OWPIT54

Angled Water Pitchers

Stylishly sleek, these satin-finished stainless steel pitchers are simple, elegant and practical.

OWPIT54 54 oz. (1.6 L)
4 ½" Dia. x 11" H, 6 ¼" W with Handle
(11.4 x 27.9, 15.9 cm)

Double-Wall Pitcher with Lid

Durable stainless steel pitcher features double-wall styling and hinged lid.

DWCP48 52 oz. (1.5 L)
4 ½" Dia. x 9" H, 6 ¼" W with Handle
(10.8 x 22.9, 15.9 cm)

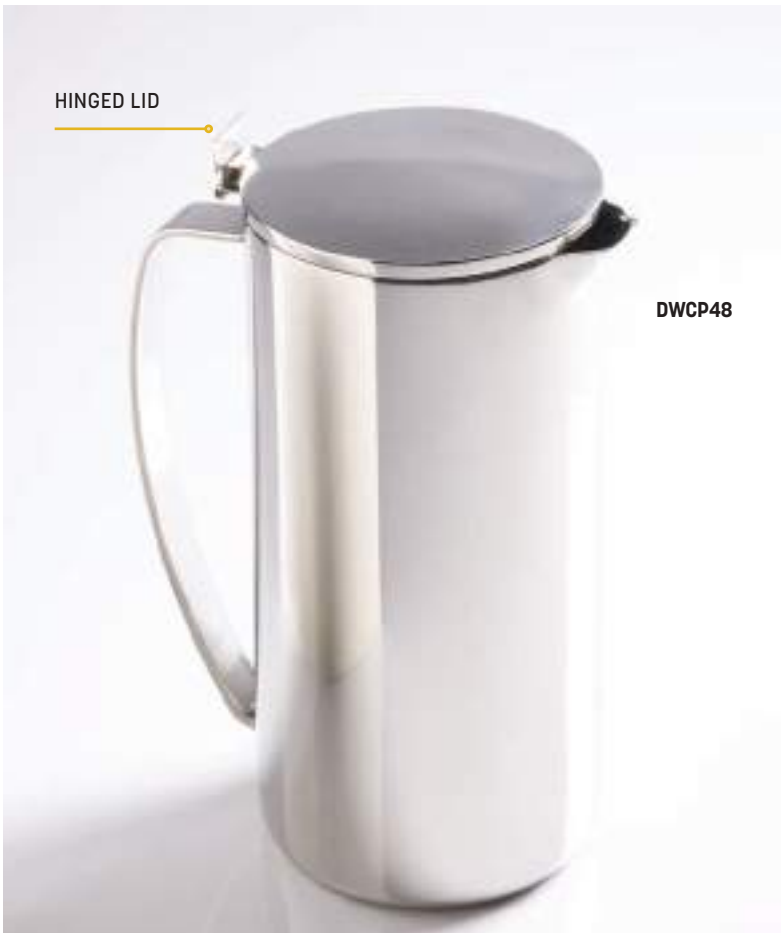

HINGED LID

DWCP48

Contemporary Pitchers

Our most modern pitchers, these stainless steel pieces feature slim design and ice guards for a brilliant blend of functionality and style.

WPSF33 33 oz. (1 L)
3 1/8" Dia. x 8 7/8" H, 5 3/8" W with Handle
(7.9 x 22.5, 13.7 cm)

WPSF67 67 oz. (2 L)
4 1/2" Dia. x 9 1/4" H, 6 3/4" W with Handle
(11.4 x 23.5, 17.1 cm)

WPSF67

WPSF33



Elegance™ Double-Wall Beverage Service

Style via consistency. This five-piece stainless steel line includes coffee pots in two sizes, a water pitcher, a sugar bowl and a creamer.

DWS5 Sugar Bowl
5 oz. (147.9 mL)
3 1/4" Dia. x 3" H
(8.3 x 7.6 cm)

DWC5 Creamer
5 oz. (147.9 mL)
3 1/2" L x 2" W x 5" H
(8.9 x 5.1 x 12.7 cm)

DWCP16 Coffee Pot
16 oz. (473.2 mL)
3" L x 5 1/4" W x 7 1/4" H
(7.6 x 13.3 x 18.4 cm)

DWWP50 Water Pitcher
50 oz. (1.5 L)
4 3/8" L x 7" W x 8" H
(11.1 x 17.8 x 20.3 cm)

DWCP50 Coffee Pot
50 oz. (1.5 L)
4 3/8" L x 7" W x 10" H
(11.1 x 17.8 x 25.4 cm)



DWWP50

DWCP50

DWS5

DWCP16

DWC5



Porcelain Creamers

These simple, round creamers bring a friendly touch to coffee service.

PCR25 2 ½ oz. (73.9 mL)
2 ½" L x 3 ¼" W x 2 ¾" H
(6.4 x 8.3 x 6 cm)

PCR55 5 ½ oz. (162.7 mL)
3" L x 4 ¾" W x 3" H
(7.6 x 11.1 x 7.6 cm)

Porcelain Bell Creamers

A quintessential design that's sure to invoke nostalgia.

PBC25 2 oz. (59.1 mL)
2 ½" L x 3" W x 3" H
(5.4 x 7.6 x 7.6 cm)

PBC45 4 oz. (118.3 mL)
3 ¼" L x 2 ¼" W x 3 ¼" H
(8.3 x 5.7 x 8.3 cm)



Ceramic Milk Carton Creamer

A surprising spin on a cafeteria classic, this design is a customer favorite.

CMCC5 5 oz. (147.9 mL)
2 ½" L x 4 ½" W x 3 ¼" H
(5.4 x 10.5 x 8.3 cm)



Black Artisanal Porcelain

With a rustic two-tone glazed finish, our black collection brings a handcrafted look to coffee and dinner service alike.

| | |
|--------------|---|
| PBBL2 | <p>Creamer 2 ½ oz. (73.9 mL) 2 ½" L x 3 ¼" W x 2 ¾" H (6.3 x 8.3 x 6 cm)</p> |
| PBBL4 | <p>Creamer 4 oz. (118.3 mL) 3 ¼" L x 2 ¼" W x 2 ¼" H (8.3 x 5.7 x 5.7 cm)</p> |
| PBL7 | <p>Bowl 7 oz. (207 mL) 3 ⅞" Dia. x 2 ¼" H (9.8 x 5.7 cm)</p> |
| PSBL | <p>Sugar Packet Holder 5 oz. (147.9 mL) 3 ½" L x 2 ½" W x 2" H (8.9 x 6.3 x 5.1 cm)</p> |



The Swan Collection

Just like an elegant swan's neck, this pair of glass sugar holder and creamer adds a touch of class to every table. The clear curvature of the design allows for easy serving and pouring. Pair with a stainless steel or acacia wood caddy to complete the look.

| | |
|-----------------|---|
| GC4 | <p>Glass Creamer 4 oz. (118.3 mL) 1 ¾" Dia. x 4 ⅜" H (4.4 x 11.1 cm)</p> |
| GS4 | <p>Glass Sugar Holder 4 oz. (118.3 mL) 1 ¾" Dia. x 4 ⅜" H (4.4 x 11.1 cm)</p> |
| CADDYW2 | <p>Acacia Wood Caddy 6 ⅞" L x 3 ½" W x 6 ¾" H (17.5 x 8.9 x 17.1 cm)</p> |
| CADDYSS2 | <p>Stainless Steel Caddy 6 ⅞" L x 3 ½" W x 6 ¾" H (16.8 x 8.9 x 17.1 cm)</p> |



FITS 6 OZ. CONTEMPORARY
GLASS SHAKERS ON PG. 146



Evolution™ Creamers

Silver

- SCM3** 2 ½ oz. (73.9 mL)
2" Dia. x 2" H (5.1 x 5.1 cm)
- SCM4** 4 ½ oz. (133.1 mL)
2" Dia. x 3 ½" H (5.1 x 8.9 cm)
- SCM6** 6 oz. (177.4 mL)
2" Dia. x 4 ¾" H (5.1 x 12.1 cm)

Crimped NEW

- SCMC3** 2 ½ oz. (73.9 mL)
2" Dia. x 2" H (5.1 x 5.1 cm)
- SCMC4** 4 ½ oz. (133.1 mL)
2" Dia. x 3 ½" H (5.1 x 8.9 cm)
- SCMC6** 6 oz. (177.4 mL)
2" Dia. x 4 ¾" H (5.1 x 12.1 cm)

Black

- SCMB3** 2 ½ oz. (73.9 mL)
2" Dia. x 2" H (5.1 x 5.1 cm)
- SCMB4** 4 ½ oz. (133.1 mL)
2" Dia. x 3 ½" H (5.1 x 8.9 cm)
- SCMB6** 6 oz. (177.4 mL)
2" Dia. x 4 ¾" H (5.1 x 12.1 cm)

Gold

- SCMG3** 2 ½ oz. (73.9 mL)
2" Dia. x 2" H (5.1 x 5.1 cm)
- SCMG4** 4 ½ oz. (133.1 mL)
2" Dia. x 3 ½" H (5.1 x 8.9 cm)
- SCMG6** 6 oz. (177.4 mL)
2" Dia. x 4 ¾" H (5.1 x 12.1 cm)

Hammered Bell Creamers

Just try and resist these adorable creamers in copper, gold or natural stainless steel. Your customers will be charmed by their sleek hammered design and petite frame.

Copper 💧

- CHC2** 2 oz. (59.1 mL)
2 ¼" L x 2" W x 2 ¼" H
(5.7 x 5.1 x 5.7 cm)
- CHC4** 4 oz. (118.3 mL)
3" L x 2 ¼" W x 2 ¾" H
(7.6 x 5.7 x 7 cm)

Gold 💧

- CHG2** 2 oz. (59.1 mL)
2 ¼" L x 2" W x 2 ¼" H
(5.7 x 5.1 x 5.7 cm)
- CHG4** 4 oz. (118.3 mL)
3" L x 2 ¼" W x 2 ¾" H
(7.6 x 5.7 x 7 cm)

Silver

- CHS2** 2 oz. (59.1 mL)
2 ¼" L x 2" W x 2 ¼" H
(5.7 x 5.1 x 5.7 cm)
- CHS4** 4 oz. (118.3 mL),
3" L x 2 ¼" W x 2 ¾" H
(7.6 x 5.7 x 7 cm)

Milk Carton Creamers

Silver

MCC300 3 oz. (88.7 mL)
2 3/4" L x 2" W x 2 1/4" H (7 x 5.1 x 5.7 cm)

MCC500 5 oz. (147.9 mL)
2 3/4" L x 2" W x 3" H (7 x 5.1 x 7.6 cm)

Gold

MCG300 3 oz. (88.7 mL)
2 3/4" L x 2" W x 2 1/4" H (7 x 5.1 x 5.7 cm)

MCG500 5 oz. (147.9 mL)
2 3/4" L x 2" W x 3" H (7 x 5.1 x 7.6 cm)

Black

MCB300 3 oz. (88.7 mL)
2 3/4" L x 2" W x 2 1/4" H (7 x 5.1 x 5.7 cm)

MCB500 5 oz. (147.9 mL)
2 3/4" L x 2" W x 3" H (7 x 5.1 x 7.6 cm)



PAIR THESE WITH MATCHING PIECES ON PG. 122



HOT



Shown with ST10 stainless steel tray

SSPT5

SSBV1

MCC500

SSPT3

SSPH2

SCM2

SSPH4

SSPT3



HOT

RSSPH2

SQSSPH2

SSPT3

RTSSPH3

Satin Finish Stainless Coffee/ Tabletop Accessories HOT

Straight-Sided Sugar Packet/Cube Holders

- SSPH2 2" Dia. x 2 3/4" H (5.1 x 7 cm)
- SSPT5 2" Sq. x 2 3/4" H (5.1 x 7 cm)
- SSPH4 3 1/4" L x 2 3/4" W x 1 3/4" H (8.3 x 7 x 4.4 cm)

Angled Sugar Packet/Cube Holders

- RSSPH2 2" Dia. x 2 3/4" H (5.1 x 7 cm)
- SQSSPH2 2" Sq. x 2 3/4" H (5.1 x 7 cm)
- RTSSPH3 3 1/8" L x 2 1/2" W x 1 3/4" H (7.9 x 6.4 x 4.4 cm)

Tray

- SSPT3 4 1/4" L x 2 1/4" W x 1" H (10.8 x 5.7 x 2.5 cm)

Bud Vase

- SSBV1 1 3/4" Sq. x 5 1/4" H (4.4 x 13.3 cm)

Creamers

- SCM2 4 oz. (118.3 mL)
2" Dia. x 2 3/4" H (5.1 x 7 cm)
- MCC500 5 oz. (147.9 mL)
2 3/4" L x 2" W x 3" H (7 x 5.1 x 7.6 cm)



Hammered Finish Stainless Coffee/ Tabletop Accessories

Angled Sugar Packet/Cube Holders

HMSRSPH2 2" Dia. x 2 ¾" H (5.1 x 7 cm)

HMSQPH2 2" Sq. x 2 ¾" H (5.1 x 7 cm)

HMSRSPH3 3 ½" L x 2 ½" W x 1 ¾" H (7.9 x 6.6 x 4.5 cm)

Straight-Sided Sugar Packet/Cube Holders

HMSPH2 2" Dia. x 2 ¾" H (5.1 x 7 cm)

HMSPT5 2" Sq. x 2 ¾" H (5.1 x 7 cm)

HMSPH4 3 ¼" L x 2 ¾" W x 1 ¾" H (8.3 x 7 x 4.4 cm)

Tray

HMSPT3 4 ¼" L x 2 ¼" W x 1" H (10.8 x 5.7 x 2.5 cm)

Bud Vase

HMBV1 1 ¾" Sq. x 5 ¼" H (4.4 x 13.3 cm)

Creamer

HMCM2 4 oz. (118.3 mL)
2" Dia. x 2 ¾" H (5.1 x 7 cm)





Stainless Steel Coffee Accessories

Contemporary, luxe and undeniably striking, this collection of tabletop accessories draws attention with cosmopolitan flair. Dishwasher-safe finish. Color may vary slightly.

Black

- BSPH2** Cylinder
2" Dia. x 2 3/4" H
(5.1 x 7 cm)
- BPT3** Tray
4 1/4" L x 2 1/4" W x 1" H
(10.8 x 5.7 x 2.5 cm)
- BSPT5** Square
2" Sq. x 2 3/4" H
(5.1 x 7 cm)
- BCM2** Creamer
4 oz. (118.3 mL)
2" Dia. x 2 3/4" H
(5.1 x 5.1 x 7 cm)
- BSPH4** Rectangular
3 1/4" L x 2 3/4" W x 1 3/4" H
(8.3 x 7 x 4.4 cm)



Gold

- GSPH2** Cylinder
2" Dia. x 2 3/4" H
(5.1 x 7 cm)
- GPT3** Tray
4 1/4" L x 2 1/4" W x 1" H
(10.8 x 5.7 x 2.5 cm)
- GSPT5** Square
2" Sq. x 2 3/4" H
(5.1 x 7 cm)
- GCM2** Creamer
4 oz. (118.3 mL)
2" Dia. x 2 3/4" H
(5.1 x 7 cm)
- GSPH4** Rectangular
3 1/4" L x 2 3/4" W x 1 3/4" H
(8.3 x 7 x 4.4 cm)



Hammered Aluminum Sugar Packet Holders

In your choice of super sleek colors, these aluminum sugar packet holders are sure to sweeten your coffee and tea presentation.

- ASPC** Copper
6 oz. (177.4 mL)
3 3/8" L x 2 3/8" W x 2" H
(8.6 x 6 x 5.1 cm)
- ASPB** Black
6 oz. (177.4 mL)
3 3/8" L x 2 3/8" W x 2" H
(8.6 x 6 x 5.1 cm)
- ASPS** Silver
6 oz. (177.4 mL)
3 3/8" L x 2 3/8" W x 2" H
(8.6 x 6 x 5.1 cm)
- ASPG** Gold
6 oz. (177.4 mL)
3 3/8" L x 2 3/8" W x 2" H
(8.6 x 6 x 5.1 cm)

Stainless Steel Sugar Packet Milk Crates

- SPC2** Cylinder
2" Dia. x 2 ¾" H
(5.1 x 6.9 cm)
- SPC3** Rectangular
3 ½" L x 2 ½" W x 1 ½" H
(8.9 x 6.4 x 3.8 cm)

Stainless Steel Sugar Packet Crates

- SPC** Satin
3 ½" L x 2 ½" W x 1 ½" H
(8.9 x 6.4 x 3.8 cm)
- SPH** Hammered
3 ½" L x 2 ½" W x 1 ½" H
(8.9 x 6.4 x 3.8 cm)

Galvanized Sugar Packet Holders

- GSP35** Silver
5" L x 3" W x 2" H, 6 ½" L with Handles
(12.7 x 7.6 x 5.1, 16.5 cm)
- DGSP35** Black
5" L x 3" W x 2" H, 6 ½" L with Handles
(12.7 x 7.6 x 5.1, 16.5 cm)

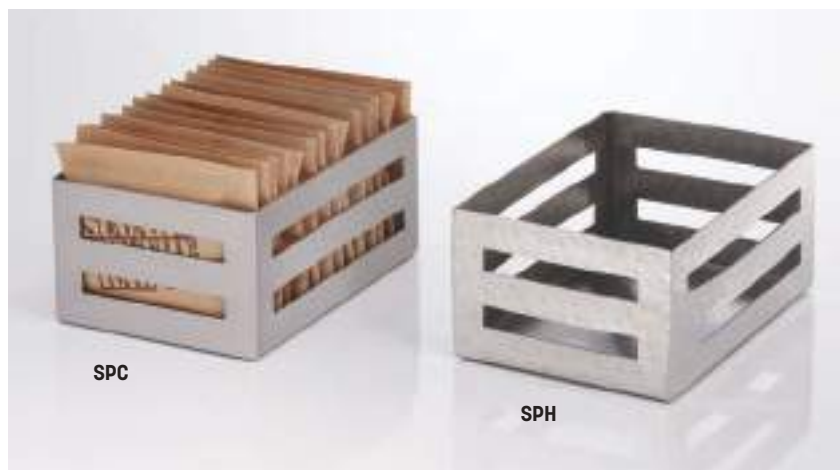



SPP326

Ceramic Sugar Packet Holder

SPP326 3 1/2" L x 2 1/2" W x 2" H
(8.9 x 6.4 x 5.1 cm)

Porcelain Sugar Packet Holders

PSPH3 3 1/4" L x 2 1/2" W x 1 7/8" H
(8.3 x 6.4 x 4.8 cm)

PSPH4 4" L x 2 1/4" W x 1 3/4" H
(10.2 x 5.7 x 4.4 cm)

Wrought Iron Sugar Packet Baskets



SBL353 Leaf
3 3/4" L x 2 3/4" W x 2 1/2" H
(9.5 x 7 x 6.4 cm)

SBS533 Scroll
3 3/4" L x 2 3/4" W x 2 1/2" H
(9.5 x 7 x 6.4 cm)

Birdnest Sugar Packet Baskets



BNSB3 Black
4 1/2" L x 2 1/4" W x 1 3/4" H
(11.4 x 5.7 x 4.4 cm)

BNSC3 Chrome
4 1/2" L x 2 1/4" W x 1 3/4" H
(11.4 x 5.7 x 4.4 cm)



PSPH4

PSPH3



SBS533

SBL353

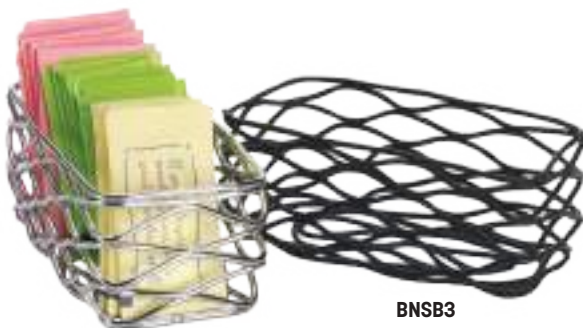

BNSC3

BNSB3

Stainless Steel Swing Waste Bins HOT

- TIM1** 4 ¾" Dia. x 6 ⅝" H
(12.1 x 16.8 cm)
- TIM2** 4 ¾" Dia. x 9" H
(12.1 x 22.9 cm)



Stainless Steel Mini Trash Cans

- OSCAR** Can
3 ¾" Dia. x 3 ½" H
(9.5 x 8.9 cm)
- OLID** Lid for OSCAR
3 ¾" Dia. x 1 ½" H
(9.5 x 3.8 cm)
- OSCAR2** Can
5" Dia. x 4 ⅞" H
(12.7 x 12.4 cm)
- OLID2** Lid for OSCAR2
5" Dia. x 1 ⅝" H
(12.7 x 4.1 cm)
- OSCAR3** Can
6" Dia. x 5 ⅞" H
(15.2 x 14.9 cm)
- OLID3** Lid for OSCAR3
6" Dia. x 1 ⅞" H
(15.2 x 4.8 cm)

Sugar and Ice Tongs

- IT400** Sugar Tongs
4" L (10.2 cm)
- IT700** Hammered Ice Tongs
6 ½" L (16.5 cm)





BNCB84

BNCC48

Birdnest Coffee Caddies

- BNCB84** Black
8 1/2" L x 4 3/8" W x 3 1/8" H
(21.6 x 11.1 x 7.9 cm)
- BNCC48** Chrome
8 1/2" L x 4 3/8" W x 3 1/8" H
(21.6 x 11.1 x 7.9 cm)

Stainless Steel Coffee Caddies

- BAR55** Satin
8" L x 4" W x 4 1/8" H
(20.3 x 10.2 x 10.5 cm)
- HMBAR9** Hammered
8" L x 4" W x 4 1/8" H
(20.3 x 10.2 x 10.5 cm)

Metal Caddies

Our most versatile bar caddies yet, this pair of stylishly functional pieces are perfect for just about any bar setting.

Antique Copper

- BARC5** Coffee Caddy
8" L x 4" W x 4 1/8" H
(20.3 x 10.2 x 10.5 cm)
- BARC7** Bar Caddy
9 1/8" L x 5 7/8" W x 4 1/8" H
(23.2 x 14.9 x 10.5 cm)

Black

- BARB5** Coffee Caddy
8" L x 4" W x 4 1/8" H
(20.3 x 10.2 x 10.5 cm)
- BARB7** Bar Caddy
9 1/8" L x 5 7/8" W x 4 1/8" H
(23.2 x 14.9 x 10.5 cm)

Gold

- BARG5** Coffee Caddy
8" L x 4" W x 4 1/8" H
(20.3 x 10.2 x 10.5 cm)
- BARG7** Bar Caddy
9 1/8" L x 5 7/8" W x 4 1/8" H
(23.2 x 14.9 x 10.5 cm)



BAR55

HMBAR9



BARC7

BARC5



BARB7

BARB5



BARG7

BARG5

NEW



Shown with GLADT6 glass shaker, PNS24 glass S&P set and MSTNG5 stainless steel tongs

PRODUCTS PWBB45 AND PWBB3 STACK FOR SIMPLE STORAGE

PWBC8

PWBS4

PWBC7

PWBB45

PWBB3



PWC8

PWC7

PWS4

PWB45

PWB3

Poplar Wood Caddies

This five-piece collection provides function and stylish coordination. Choose from rustic natural wood or sleek black.

Black

PWBS4 4" L x 3 5/8" W x 1 5/8" H
(10.2 x 9.2 x 4 cm)

PWBB3 3 5/8" L x 3 7/8" W x 3 1/2" H
(9.2 x 9.8 x 9 cm)

PWBB45 4 5/8" L x 5" W x 3 3/4" H
(11.7 x 12.7 x 9.5 cm)

PWBC7 7 1/2" L x 6 1/2" W x 5 1/8" H
(19.1 x 16.5 x 13 cm)

PWBC8 6 5/8" L x 6 1/2" W x 7 1/4" H
(16.8 x 16.5 x 18.4 cm)

Natural

PWS4 4" L x 3 5/8" W x 1 5/8" H
(10.2 x 9.2 x 4 cm)

PWB3 3 5/8" L x 3 7/8" W x 3 1/2" H
(9.2 x 9.8 x 9 cm)

PWB45 4 5/8" L x 5" W x 3 3/4" H
(11.7 x 12.7 x 9.5 cm)

PWC7 7 1/2" L x 6 1/2" W x 5 1/8" H
(19.1 x 16.5 x 13 cm)

PWC8 6 5/8" L x 6 1/2" W x 7 1/4" H
(16.8 x 16.5 x 18.4 cm)



WCV4 shown with BWC12 condiment rack

SEE OUR MATCHING WOOD CRATES ON PG. 299-301

WCV7



WCBA4 shown with TASSM stand, BEE316 shaker and TIM1 waste bin

WCBA7

Wood Caddies

Our crates in vintage, bamboo and black wood are so popular that we have expanded into matching caddies.

Vintage

WCV4 3 7/8" Sq. x 4 3/4" H
(9.8 x 12.1 cm)

WCV7 7 1/2" L x 6 1/4" W x 4 3/4" H
(19.1 x 15.9 x 12.1 cm)

Bamboo

WCBA4 3 7/8" Sq. x 4 3/4" H
(9.8 x 12.1 cm)

WCBA7 7 1/2" L x 6 1/4" W x 4 3/4" H
(19.1 x 15.9 x 12.1 cm)

Black

WCBL4 3 7/8" Sq. x 4 3/4" H
(9.8 x 12.1 cm)

WCBL7 7 1/2" L x 6 1/4" W x 4 3/4" H
(19.1 x 15.9 x 12.1 cm)



PERFECT FOR COFFEE STATIONS

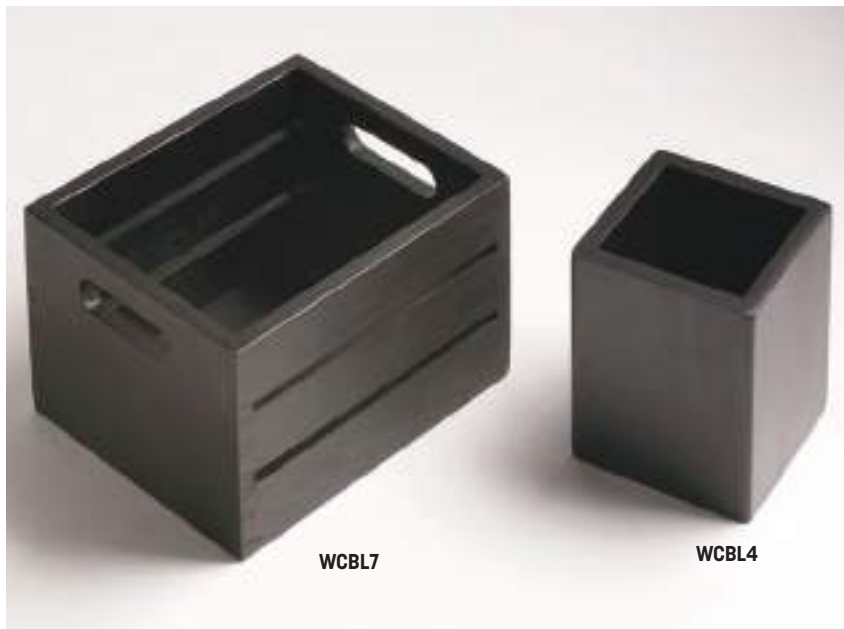

WCBL7

WCBL4



Porcelain Sauce Cups

PCG2 Gray
2 oz. (59.1 mL)
2" Dia. x 1 1/2" H (5.1 x 3.8 cm)

PCWH2 White
2 oz. (59.1 mL)
2" Dia. x 1 1/2" H (5.1 x 3.8 cm)

Porcelain Three-Compartment Sauce Dish

Try serving sauces, tiny desserts, hors d'oeuvres and more in this elegant, low-profile triptych.

PORSD3R 1 1/2 oz. (44.4 mL)
5 3/4" L x 3 1/8" W x 1" H
(14.6 x 7.9 x 2.5 cm)

Mini Ceramic Fry Pan

The pouring spout and handle on this petite piece make it exceptionally versatile.

CFP4 4 oz. (118.3 mL)
3 1/2" Dia. x 1 1/2" H
5 1/8" W with Handle
(13 x 8.9 x 3.8, 13 cm)





Round and Porcelain Sauce Cups

Originally designed for sauces, these beauties also set the stage for salts, oils, condiments and more.

PRSD3 1 ½ oz. (44.4 mL)
3" Dia. x ¾" H (7.6 x 1.9 cm)

PSLT17 ½ oz. (14.8 mL)
1 ¾" Dia. x ¾" H (4.4 x 1.9 cm)

PSLT2 1 oz. (29.6 mL)
2 ⅝" Dia. x 1" H (5.4 x 2.5 cm)

Squavy™ Porcelain Sauce Cups

SQVY1 1 ½ oz. (44.4 mL)
2 ¼" Dia. x 1 ½" H (5.7 x 3.8 cm)

SQVY2 2 ½ oz. (73.9 mL)
2 ½" Dia. x 1 ⅝" H (6.4 x 4.1 cm)

SQVY3 5 oz. (147.9 mL)
3 ½" Dia. x 1 ⅞" H (8.9 x 4.8 cm)

SQVY4 15 oz. (443.6 mL)
4 ½" Dia. x 2 ½" H (11.4 x 6.6 cm)

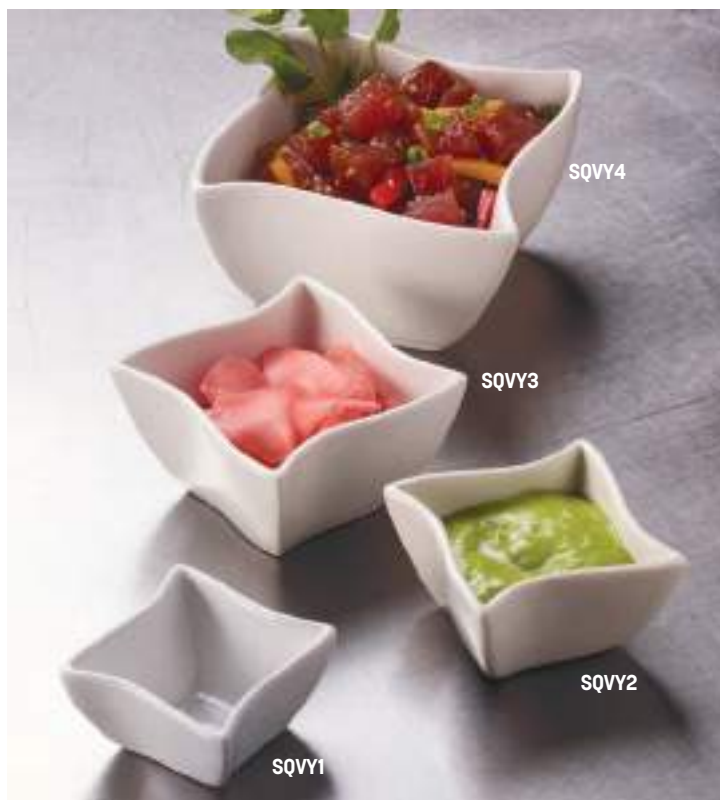

Squound™ Ceramic Sauce Cups

SQSC15 1 ½ oz. (44.4 mL)
2 ¾" Dia. x 1" H (7 x 2.5 cm)

SQSC20 2 oz. (59.1 mL)
3" Dia. x 1" H (7.6 x 2.5 cm)

SQSC30 3 oz. (88.7 mL)
3 ½" Dia. x 1 ¼" H (8.9 x 3.2 cm)

SQSC40 4 oz. (118.3 mL)
4" Dia. x 1 ½" H (10.2 x 3.8 cm)





Ceramekins™

- CRMK2** 2 oz. (59.1 mL)
2 ¾" Dia. x 1 ¼" H (7 x 3.2 cm)
- CRMK4** 4 oz. (118.3 mL)
3 ½" Dia. x 1 ⅝" H (8.9 x 4.1 cm)
- CRMK6** 6 oz. (177.4 mL)
3 ⅝" Dia. x 1 ⅝" H (9.5 x 4.1 cm)

Square Porcelain Sauce Cups

When a culinary experience consists of a single bite, these porcelain cups are the perfect solution.

- CSC15** 1 ½ oz. (44.4 mL)
1" Sq. x 1 ⅝" H (2.5 x 2.9 cm)
- CSC20** 2 oz. (59.1 mL)
2 ½" Sq. x 1 ⅜" H (6.4 x 3.5 cm)
- PORD39** 2 oz. (59.1 mL)
3" Sq. x 1" H (7.6 x 2.5 cm)
- PORB29** 4 oz. (118.3 mL)
3" Sq. x 2" H (7.6 x 5.1 cm)
- PORB30** 5 ½ oz. (162.7 mL)
3 ¼" Sq. x 2 ¼" H (8.3 x 5.7 cm)





Flared Stainless Steel Sauce Cups

- FT15** 2 oz. (59.1 mL)
2 5/8" Dia. x 1 1/4" H (6.7 x 3.2 cm)
- FT25** 3 oz. (88.7 mL)
3" Dia. x 1 1/2" H (7.6 x 3.8 cm)
- FT40** 4 oz. (118.3 mL)
3 3/8" Dia. x 1 7/8" H (8.6 x 4.8 cm)

Double-Wall Stainless Steel Sauce Cup

- DWSC7** 7 oz. (207 mL)
3 3/8" Dia. x 2 5/8" H (8.6 x 6.7 cm)

Ribbed Stainless Steel Sauce Cups

- RSC3** 1 1/2 oz. (44.4 mL)
2 1/2" Dia. x 1" H (6.4 x 2.5 cm)
- RSC1** 2 1/2 oz. (73.9 mL)
2 1/4" Dia. x 1 3/4" H (5.7 x 4.4 cm)
- RSC4** 4 oz. (118.3 mL)
3" Dia. x 2" H (7.6 x 5.1 cm)

Fluted Stainless Steel Sauce Cups

- RB15** 1 1/2 oz. (44.4 mL)
2 1/2" Dia. x 7/8" H (6.4 x 2.2 cm)
- RB25** 2 1/2 oz. (73.9 mL)
2 3/8" Dia. x 1 5/8" H (6 x 4.1 cm)

SATIN FINISH DELIVERS
EASY ELEGANCE



DWSC7



RB15

RB25



RSC4

RSC3

RSC1

HOT

STAINLESS STEEL MAKES THIS COLLECTION SHINE



Stainless Steel Sauce Cups HOT

- MB3** 1 ½ oz. (44.4 mL)
2 ½" Dia. x 1" H (6.4 x 2.5 cm)
- MB1** 2 ½ oz. (73.9 mL)
2 ¼" Dia. x 1 ¾" H (5.7 x 4.4 cm)
- MB4** 4 oz. (118.3 mL)
3" Dia. x 2" H (7.6 x 5.1 cm)
- SSC15** 1 ½ oz. (44.4 mL)
2 ¾" Sq. x 1" H (6 x 2.5 cm)
- D404** 1 ½ oz. (44.4 mL)
2 ¾" L x 2" W x ½" H (7 x 5.1 x 1.3 cm)
- D405** 2 ½ oz. (73.9 mL)
3 ⅞" L x 3" W x ⅞" H (9.8 x 7.6 x 2.2 cm)
- SSC25** 2 ½ oz. (73.9 mL)
2 ¾" Sq. x 1 ⅜" H (6 x 3.5 cm)
- D406** 4 oz. (118.3 mL)
4 ⅝" L x 3 ¾" W x ⅞" H (11.7 x 9.5 x 2.2 cm)
- B34** 3 ½ oz. (103.5 mL)
3 ¼" Dia. x 1 ¼" H (8.3 x 3.2 cm)

Large Capacity Stainless Steel Sauce Cups

- B31** Mirror Finish
8 oz. (236.6 mL)
3 ⅝" Dia. x 2 ¼" H (9.2 x 5.7 cm)
- BS31** Satin Finish
8 oz. (236.6 mL)
3 ⅝" Dia. x 2 ¼" H (9.2 x 5.7 cm)
- BH31** Hammered
8 oz. (236.6 mL)
3 ⅝" Dia. x 2 ¼" H (9.2 x 5.7 cm)

Round Hammered Stainless Steel Sauce Cups HOT

Add a lustrous quality to your tabletop with gorgeous hammered stainless steel sauce cups. Available in a variety of sizes and dishwasher-safe colors. Color may vary slightly.

Silver

- HAMSC3** 1 ½ oz. (44.4 mL)
2 ¼" Dia. x 1" H (5.7 x 2.5 cm)
- HAMSC** 2 ½ oz. (73.9 mL)
2 ¼" Dia. x 1 ¾" H (5.7 x 4.4 cm)
- HAMSC4** 4 oz. (118.3 mL)
2 ¾" Dia. x 2" H (7 x 5.1 cm)

Black

- HAMSCB3** 1 ½ oz. (44.4 mL)
2 ¼" Dia. x 1" H (5.7 x 2.5 cm)
- HAMSCB** 2 ½ oz. (73.9 mL)
2 ¼" Dia. x 1 ¾" H (5.7 x 4.4 cm)
- HAMSCB4** 4 oz. (118.3 mL)
2 ¾" Dia. x 2" H (7 x 5.1 cm)

Gold

- HAMSCG3** 1 ½ oz. (44.4 mL)
2 ¼" Dia. x 1" H (5.7 x 2.5 cm)
- HAMSCG** 2 ½ oz. (73.9 mL)
2 ¼" Dia. x 1 ¾" H (5.7 x 4.4 cm)
- HAMSCG4** 4 oz. (118.3 mL)
2 ¾" Dia. x 2" H (7 x 5.1 cm)

Square Hammered Stainless Steel Sauce Cups

- HAMSC15** 1 ½ oz. (44.4 mL)
2" Sq. x 1" H (5.1 x 2.5 cm)
- HAMSC25** 2 ½ oz. (73.9 mL)
2 ¼" Sq. x 1 ¼" H (5.7 x 3.2 cm)





SMB5

SMB4

SMB3

GREAT FOR INDIVIDUAL SERVINGS



DWSS5

DWS2

**Straight-Sided Satin Finish
Stainless Steel Mini Bowls**

- SMB3** 4 oz. (118.3 mL)
3" Dia. x 1" H (7.6 x 2.5 cm)
- SMB4** 8 oz. (236.6 mL)
4" Dia. x 1 1/4" H (10.2 x 3.2 cm)
- SMB5** 15 oz. (443.6 mL)
5" Dia. x 1 1/4" H (12.7 x 3.2 cm)

**Double-Wall Stainless Steel Angled
Mini Bowls**

Satin Finish

- DWS2** 2.5 oz. (73.9 mL)
3" Dia. x 2 3/4" H (7.6 x 7 cm)
- DWSS5** 5 oz. (147.9 mL)
3 1/2" Dia. x 3" H (8.9 x 7.6 cm)

Hammered

- HDWS2** 2.5 oz. (73.9 mL)
3" Dia. x 2 3/4" H (7.6 x 7 cm)
- HDWS5** 5 oz. (147.9 mL)
3 1/2" Dia. x 3" H (8.9 x 7.6 cm)



HDWS5

HDWS2



Oval Hammered Sauce Cups

These tiny oval sauce cups dress up any dish in need of an accompaniment. Available in sleek finishes and multiple sizes.

Stainless Steel

- HS2** 2 oz. (59.1 mL)
2 ½" L x 2" W x 1 ¼" H
(6.3 x 5 x 3.1 cm)
- HS3** 3 oz. (88.7 mL)
2 ¾" L x 2" W x 1 ¼" H
(6.9 x 5 x 3.1 cm)
- HS4** 4 oz. (118.3 mL)
3 ¼" L x 2 ¾" W x 1 ½" H
(8.2 x 6.9 x 3.8 cm)
- HS8** 8 oz. (236.5 mL)
3 ¾" L x 3" W x 2" H
(9.5 x 7.6 x 5 cm)

Copper

- HSC2** 2 oz. (59.1 mL)
2 ½" L x 2" W x 1 ¼" H
(6.3 x 5 x 3.1 cm)
- HSC3** 3 oz. (88.7 mL)
2 ¾" L x 2" W x 1 ¼" H
(6.9 x 5 x 3.1 cm)
- HSC4** 4 oz. (118.3 mL)
3 ¼" L x 2 ¾" W x 1 ½" H
(8.2 x 6.9 x 3.8 cm)
- HSC8** 8 oz. (236.5 mL)
3 ¾" L x 3" W x 2" H
(9.5 x 7.6 x 5 cm)





Mini Melamine Serving Dishes BPA FREE

Let's face it. Cute sells and these mini melamine bowls and plates are the epitome of adorable! Use as a small dish to plate up small bites or to creatively serve sauces and condiments. These guys may be small, but they pack a powerful punch in versatility.

Rectangular Plates

MMP6 6 5/8" L x 4 3/8" W x 7/8" H
(16.8 x 11.1 x 2.2 cm)

MMP8 8 1/2" L x 5 3/4" W x 1" H
(21.6 x 14.6 x 2.5 cm)

Round Bowls

MMB3 3 oz. (88.7 mL)
3 3/4" Dia. x 1 1/8" H
(9.5 x 2.9 cm)

MMB6 6 oz. (177.4 mL)
4 1/2" Dia. x 1 1/4" H
(11.4 x 3.2 cm)

MMB9 9 oz. (266.2 mL)
5 1/2" Dia. x 1 3/8" H
(14 x 3.5 cm)

Handled Bowls

MMBH3 3 oz. (88.7 mL)
4" L x 3 5/8" W x 2 1/4" H
(10.2 x 2.9 x 5.7 cm)

MMBH7 7 oz. (207 mL)
4 1/4" L x 4 3/4" W x 3" H
(10.8 x 12.1 x 7.6 cm)

Shaped Bowls

MMOB1 1 1/2 oz. (44.4 mL)
4 5/8" L x 2 5/8" W x 2 1/8" H
(11.7 x 6.7 x 5.4 cm)

MMOB2 2 oz. (59.1 mL)
4 1/4" L x 3 3/8" W x 1" H
(10.8 x 8.6 x 2.5 cm)

MMOB25 2 1/2 oz. (73.9 mL)
4 1/4" L x 2 1/2" W x 1 5/8" H
(10.8 x 6.4 x 4.1 cm)

MMOB3 3 oz. (88.7 mL)
5 1/2" L x 3" W x 1 1/4" H
(14 x 7.6 x 3.2 cm)



Unity Collection Sauce Cups

Round

USCR2GE Graphite
2 oz. (59.1 mL)
2 1/2" Dia. x 1 5/8" H
(6.4 x 4.1 cm)

USCR2MO Mocha
2 oz. (59.1 mL)
2 1/2" Dia. x 1 5/8" H
(6.4 x 4.1 cm)

Square

USCS2GE Graphite
2 oz. (59.1 mL)
2" Sq. x 1 5/8" H
(5.1 x 4.1 cm)

USCS2MO Mocha
2 oz. (59.1 mL)
2" Sq. x 1 5/8" H
(5.1 x 4.1 cm)



Crave Collection Sauce Cups

CSC4SH Shadow
4 1/2 oz. (133.1 mL)
3 1/4" Dia. x 2" H
(8.3 x 5.1 cm)

CSC4CL Cloud
4 1/2 oz. (133.1 mL)
3 1/4" Dia. x 2" H
(8.3 x 5.1 cm)

CSC4ST Storm
4 1/2 oz. (133.1 mL)
3 1/4" Dia. x 2" H
(8.3 x 5.1 cm)
(not shown)



Jane Collection Sauce Cups

DSC1WH 1 oz. (29.6 mL)
2 3/4" Dia. x 7/8" H
(7 x 2.2 cm)

DSC3WH 2 3/4 oz. (81.3 mL)
3 1/2" Dia. x 1" H
(8.9 x 2.5 cm)

MSC8 8 oz. (236.6 mL)
3 5/8" Dia. x 2 1/8" H
(9.2 x 5.4 cm)





MSCSB3

MSCRW2

MSCRB2

MSCSW3

STYLISHLY STACKABLE FOR PRESENTATION AND STORAGE



MELBPH

Matte Finish Melamine Stackable Sauce Cups BPA FREE

Round

MSCRB2 Black,
2 ½ oz. (73.9 mL)
2 ¾" Dia. x 1 ¾" H (6 x 4.5 cm)

MSCRW2 White
2 ½ oz. (73.9 mL)
2 ¾" Dia. x 1 ¾" H (6 x 4.5 cm)

Square

MSCSB3 Black
3 oz. (88.7 mL)
2 ¾" Sq. x 1 ¾" H (6 x 4.5 cm)

MSCSW3 White
3 oz. (88.7 mL)
2 ¾" Sq. x 1 ¾" H (6 x 4.5 cm)

Melamine Butter Dish BPA FREE

MELBPH 1 oz. (29.6 mL)
2 ½" Dia. x 1 ⅞" H (6.4 x 2.9 cm)



CRAFTED TO BE DURABLE AND DISHWASHER-SAFE

TSCB2

Black Triangular Bamboo Fiber Sauce Cup

TSCB2 2 oz. (59.1 mL)
2 ⅝" Triangle x 1 ½" H (6.7 x 3.8 cm)

Melamine Ramekins **White with Smooth Sides**

| | |
|----------------|--|
| MRS150W | 1 ½ oz. (44.4 mL) 2 ¾" Dia. x 1 ½" H (6 x 3.8 cm) |
| MRS200W | 2 oz. (59.1 mL) 2 7/8" Dia. x 1 ½" H (7.3 x 3.8 cm) |
| MRS300W | 3 oz. (88.7 mL) 3 ¼" Dia. x 1 7/8" H (8.3 x 4.8 cm) |
| MRS400W | 4 oz. (118.3 mL) 3 ¼" Dia. x 2" H (8.3 x 5.1 cm) |
| MRS600W | 6 oz. (177.4 mL) 3 7/8" Dia. x 2" H (9.8 x 5.1 cm) |

Black with Smooth Sides

| | |
|-----------------|--|
| MRS150BL | 1 ½ oz. (44.4 mL) 2 ¾" Dia. x 1 ½" H (6 x 3.8 cm) |
| MRS200BL | 2 oz. (59.1 mL) 2 7/8" Dia. x 1 ½" H (7.3 x 3.8 cm) |
| MRS300BL | 3 oz. (88.7 mL) 3 ¼" Dia. x 1 7/8" H (8.3 x 4.8 cm) |
| MRS400BL | 4 oz. (118.3 mL) 3 ¼" Dia. x 2" H (8.3 x 5.1 cm) |
| MRS600BL | 6 oz. (177.4 mL) 3 7/8" Dia. x 2" H (9.8 x 5.1 cm) |

White with Fluted Sides

| | |
|----------------|--|
| MRF150W | 1 ½ oz. (44.4 mL) 2 ½" Dia. x 1 ½" H (6.4 x 3.8 cm) |
| MRF250W | 2 oz. (59.1 mL) 2 ¾" Dia. x 1 ½" H (7 x 3.8 cm) |
| MRF350W | 3 oz. (88.7 mL) 3 1/8" Dia. x 1 5/8" H (7.9 x 4.1 cm) |
| MRF450W | 4 oz. (118.3 mL) 3 ¼" Dia. x 2" H (8.3 x 5.1 cm) |

Black with Fluted Sides

| | |
|-----------------|--|
| MRF150BL | 1 ½ oz. (44.4 mL) 2 ½" Dia. x 1 ½" H (6.4 x 3.8 cm) |
| MRF250BL | 2 oz. (59.1 mL) 2 ¾" Dia. x 1 ½" H (7 x 3.8 cm) |
| MRF350BL | 3 oz. (88.7 mL) 3 1/8" Dia. x 1 5/8" H (7.9 x 4.1 cm) |
| MRF450BL | 4 oz. (118.3 mL) 3 ¼" Dia. x 2" H (8.3 x 5.1 cm) |

Square Melamine Sauce Cups **White**

| | |
|----------------|---|
| MELSC15 | 1 oz. (29.6 mL) 2" Sq. x 1 3/8" H (5.1 x 3.5 cm) |
| MELSC20 | 2 oz. (59.1 mL) 2 ½" Sq. x 1 5/8" H (6.4 x 4.1 cm) |

Black

| | |
|-----------------|---|
| MELSCB51 | 1 oz. (29.6 mL) 2" Sq. x 1 3/8" H (5.1 x 3.5 cm) |
| MELSCB21 | 2 oz. (59.1 mL) 2 ½" Sq. x 1 5/8" H (6.4 x 4.1 cm) |



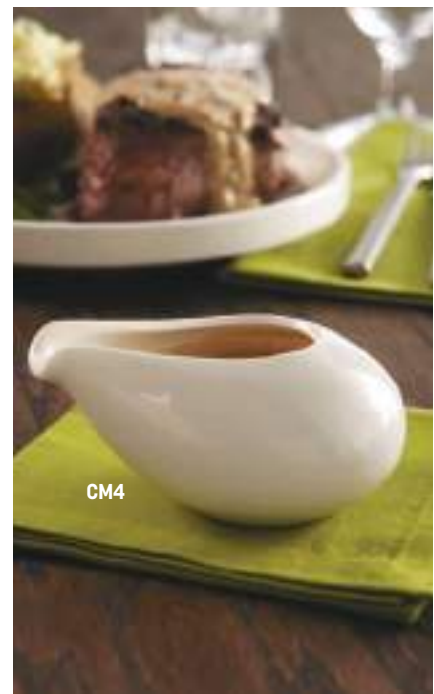
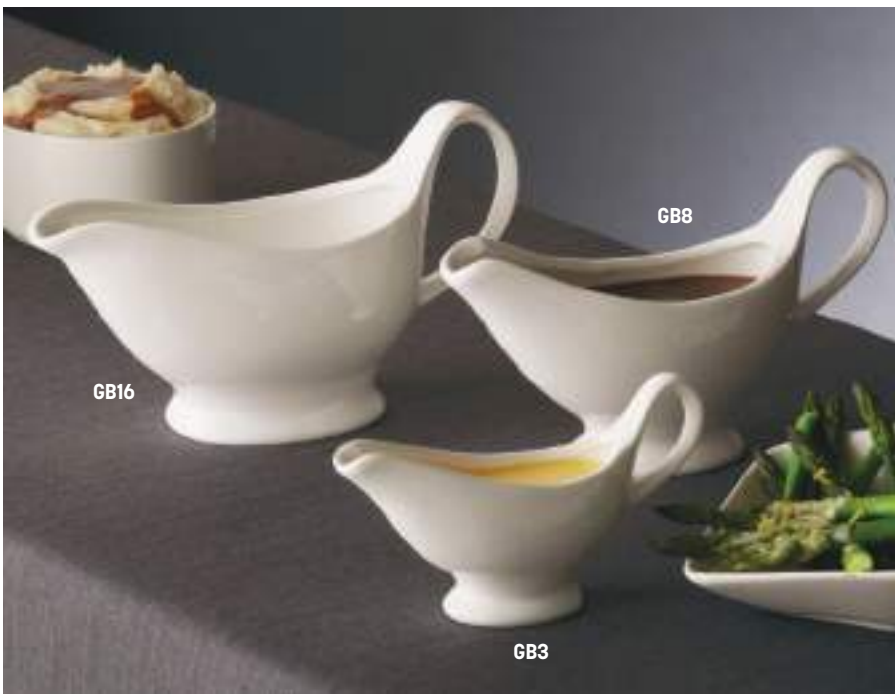

Porcelain Gravy Boats

This classic design comes in three different sizes.

- GB3** 3 oz. (88.7 mL)
6" L x 1 3/4" W x 3 1/2" H
(15.2 x 4.5 x 8.9 cm)
- GB8** 9 oz. (266.2 mL)
8" L x 2 3/4" W x 5" H
(20.3 x 7 x 12.7 cm)
- GB16** 16 oz. (473.2 mL)
9" L x 3 1/2" W x 5 1/4" H
(22.9 x 8.9 x 13.3 cm)

Porcelain Sauce Server

Creamer by day and gravy boat by night, this modern piece features organic curves and a unique handle-free design.

- CM4** 4 oz. (118.3 mL)
3 3/4" L x 2 3/4" W x 2" H
(9.5 x 7 x 5.1 cm)

Stainless Steel Gravy Boats

Perfect for gravy or salad dressings.

- GB300** 3 oz. (88.7 mL)
5 7/8" L x 2 5/8" W x 2 7/8" H
(14.9 x 6.7 x 7.3 cm)
- GB500** 5 oz. (147.9 mL)
7 1/8" L x 3" W x 2 3/4" H
(18.1 x 7.6 x 7.9 cm)
- GB1000** 10 oz. (295.7 mL)
8 3/4" L x 3 3/4" W x 3 1/4" H
(22.2 x 9.5 x 8.3 cm)
- GB1600** 16 oz. (473.2 mL)
9 1/4" L x 4 3/4" W x 4 3/4" H
(23.5 x 12.1 x 12.1 cm)

Stainless Steel Bell Creamers/Syrup Servers

Stainless steel with mirror finish.

- CP150** NEW 1 ½ oz. (44.4 mL)
1 ¾" Dia. x 2" H, 2 ¾" W with Handle
(4.4 x 5.1, 7 cm)
- CP300** 3 oz. (88.7 mL)
2 ½" Dia. x 2 ¾" H, 3 ¾" W with Handle
(5.4 x 6, 9.5 cm)
- CP500** 5 oz. (147.9 mL)
2 ½" Dia. x 2 ¾" H, 4 ¼" W with Handle
(6.4 x 7.3, 10.8 cm)



Ceramic Bud Vases

These simple vases are designed to make the flowers inside pop with color.

Black

- BVJGB5** 2 ⅛" Dia. x 3 ⅞" H
(5.4 x 9.8 cm)
- BVTB7** 1 ½" Dia. x 4" H
(3.8 x 10.2 cm)

White

- BVJGG4** 2" Dia. x 3 ⅞" H
(5.1 x 9.8 cm)
- BVTG6** 1 ½" Dia. x 4" H
(3.8 x 10.2 cm)

Marble NEW

- BVJM8** 2 ⅛" Dia. x 3 ⅞" H
(5.4 x 9.8 cm)
- BVTM9** 1 ½" Dia. x 4" H
(3.8 x 10.2 cm)



NEW



2 oz. Contemporary Glass Shakers

With glass bodies and a variety of stainless steel tops, these shakers feature eye-catching contemporary design. 2" Dia. x 3 1/8" H (5.1 x 7.9 cm).

GLACT2 Shaker with Cheese Top

GLAST2 Shaker with Slotted Top

GLADT2 Shaker with Adjustable Dial Top

GLBASE Shaker Base Only

Replacement Shaker Tops

CT2 Cheese Round Holes

ST2 Spice Slotted

DT2 Adjustable Dial Top

CAP2 Plastic Cover for Top

6 oz. Contemporary Glass Shakers

This stylishly modern line of glass shakers is an instant classic. Each measures in at 2 3/8" Dia. x 4 1/2" H (6 x 11.4 cm).

4406 Shaker with Cheese Top

4407 Shaker with Slotted Top

GLADT6 Shaker with Adjustable Dial Top

GLA600 Shaker Base Only

Replacement Shaker Tops

4406T Cheese Round Holes
2 3/4" Dia. x 1 1/8" H (7 x 2.9 cm)

4407T Spice Slotted
2 3/4" Dia. x 1 1/8" H (7 x 2.9 cm)

DT6 Adjustable Dial Top
2 3/4" Dia. x 1 1/8" H (7 x 2.9 cm)

CAP25 Plastic Cover for Top



6 oz. Vintage Glass Shakers

Part of the Vintage Collection that includes the salt & pepper shakers on pg. 151, these cheese and spice shakers feature stainless steel caps and are dishwasher-safe.

GSC6 Shaker with Cheese Top
6 oz. (177.4 mL)
2 5/8" Sq. x 3 3/4" H (6.7 x 9.5 cm)

GSS6 Shaker with Slotted Top
6 oz. (177.4 mL)
2 5/8" Sq. x 3 3/4" H (6.7 x 9.5 cm)

GSD6 Shaker with Adjustable Dial Top
6 oz. (177.4 mL)
2 5/8" Sq. x 3 3/4" H (6.7 x 9.5 cm)



4 oz. Mason Jar Salt & Pepper Shaker Set

For a fun alternative use of these shakers, remove the caps and pair them with our flight boards (pg. 244) for craft beer tastings.

MSP4 4 oz. (118.3 mL)
5" L x 4 3/4" W x 4" H
(12.7 x 12.1 x 10.2 cm)

6 oz. Swirl Jar Shakers

Our take on classic pizzeria styling. 6 oz. (177.4 mL) capacity.
2 5/8" Dia. x 3 1/2" H (6.7 x 8.9 cm).

Glass

3306 Shaker with Cheese Top

3307 Shaker with Spice Top

PET

LX306 Shaker with Cheese Top
(not shown)

LX307 Shaker with Spice Top
(not shown)

Shipped complete with tops.

8 oz. Glass Shakers

Ideal for condiments such as red pepper, oregano and parmesan cheese. 8 oz. (236.6 mL) capacity.
2 3/4" Dia. x 3 7/8" H (7 x 9.8 cm).

3308 Shaker with Cheese Top

3309 Shaker with Spice Top

16 oz. Satin Finish Stainless Steel Shakers

In stainless steel, these shakers feature fine or coarse holes for different seasonings.
16 oz. (473.2 mL) capacity.
3" Dia. x 7" H (7.6 x 17.8 cm).

TSF7 Shaker with Fine Holes

TSC7 Shaker with Coarse Holes





BEE312

BEE317

BEE319

BEE318

BEE316



BEE607

BHM2



BEE606

12 oz. Glass Beehive Shakers

Our line of stylishly ridged beehive shakers begins with these standard 12 oz. (354.9 mL) pieces. 3" Dia. x 5 3/8" H (7.6 x 13.7 cm).

BEE312 Shaker with Cheese Top

BEE316 Shaker with Sugar Flap Top

BEE317 Shaker with Spice Top

BEE318 Shaker with Dredge Top

BEE319 Shaker with Extra Large Holes Cheese Top

BEE300 Shaker Base Only

2 oz. Glass Beehive Shakers

These 2 oz. (59.1 mL) beehive shakers feature a charming pear-shaped design. 2" Dia. x 3 3/4" H (5.1 x 9.5 cm).

BHM2 Salt & Pepper Shakers

6 oz. Glass Beehive Shakers

These 6 oz. (177.4 mL) feature a ridged glass design. 2 3/4" Dia. x 4 1/8" H (7 x 10.5 cm).

BEE606 Shaker with Cheese Top

BEE607 Shaker with Spice Top

BEE600 Shaker Base Only



12 oz. Shakers

These 12 oz. (354.9 mL) fluted shakers are stain-proof, dishwasher-safe and crafted from nearly indestructible SAN plastic or crystal clear glass. Sugar top has a self-closing flap. 3" Dia. x 5 3/8" H (7.6 x 13.7 cm).

Glass

GLA312 Shaker with Cheese Top

GLA316 Shaker with Sugar Flap Top

GLA317 Shaker with Spice Top

GLA318 Shaker with Dredge Top

GLA319 Shaker with Extra Large 1/4" Holes Cheese Top

GLA300 Shaker Base Only

SAN Plastic

SAN312 Shaker with Cheese Top

SAN316 Shaker with Sugar Flap Top

SAN317 Shaker with Spice Top

SAN318 Shaker with Dredge Top

SAN319 Shaker with Extra Large 1/4" Holes Cheese Top

SAN300 Shaker Base Only

12 oz. Plastic Shakers

These 12 oz. (354.9 mL) paneled shakers are stain-proof, dishwasher-safe and crafted from nearly indestructible plastic. Sugar top has a self-closing flap. 3" Dia. x 5 3/8" H (7.6 x 13.7 cm).

3312 Shaker with Cheese Top

3316 Shaker with Sugar Flap Top

3317 Shaker with Spice Top

3318 Shaker with Dredge Top

3319 Shaker with Extra Large 1/4" Holes Cheese Top

3300 Shaker Base Only





SD10

NEW

Glass Syrup Dispenser ^{NEW}

With this contemporary design, this durable glass syrup dispenser is a great addition to any tabletop. Featuring an easy-pour lever and screw-on top, this dispenser efficiently serves your syrup, honey, and dressings. Replacement top available separately.

- SD10** Syrup Dispenser with Screw-On Top
10 oz. (295.7 mL)
3 1/4" Dia. x 5" H (8.3 x 12.7 cm)

SGLR Chrome Plated Syrup Replacement Lid



M317T
M316T
M312T
M30SP



MINIATURE DESIGN IS EXTRA EASY TO CARRY

MGLCS

Mini Glass Shakers and Caddy

This stainless steel rack and its matching glass shakers are a fraction of the size of regular shakers.

- MGLA3** 2 oz. (59.1 mL) Jar
1 5/8" Dia. x 3 5/8" H (4.1 x 9.2 cm)

MCADDY Caddy
4 1/2" L x 2 1/4" W x 5 1/2" H (11.4 x 5.7 x 14 cm)

- MGLCS** Set (Includes Caddy and Cheese with Spice Shakers)



Replacement Shaker Tops

- M30SP** Salt and Pepper
- M312T** Cheese
- M316T** Sugar Flap Top
- M317T** Spice

Shaker Tops

6 oz. and 8 oz. Tops

- 3307T** Spice Slotted
- 3306T** Cheese Round

12 oz. Tops

- 3312T** Cheese
- 3316T** Sugar Top Flap
- 3317T** Slotted Spice
- 3319T** Cheese Shaker with Extra Large Holes (1/4" Hole)
- 3318T** Dredge with Small Round Holes



3317T
3316T
3319T
3307T
3312T
3306T
3318T

Glass Lightbulb Salt & Pepper Shaker Sets

A shaker and conversation piece, all in one. These eclectic shakers look just like the real thing.

SPLB7 4 oz. (118.3 mL)
2 1/8" Dia. x 4" H (5.4 x 10.2 cm)

SPLBCAP Replacement Caps
1" Dia. x 3/4" H (2.5 x 1.9 cm)

Vintage Glass Salt & Pepper Sets

A timeless way to keep the essentials on hand, these salt & pepper sets add a dash of retro style to diner booths and dinner tables.

GSPR Ribbed Round
2 oz. (59.1 mL)
1 1/2" Dia. x 4 1/2" H (3.8 x 11.4 cm)

GSPC Round
2 oz. (59.1 mL)
1 1/2" Dia. x 4 1/2" H (3.8 x 11.4 cm)

GSPSR Ribbed Square
2 oz. (59.1 mL)
2" Sq. x 2 1/2" H (5.1 x 6.3 cm)

GSPS Square
2 oz. (59.1 mL)
2" Sq. x 2 1/2" H (5.1 x 6.3 cm)

GR2 Replacement Caps
1 1/2" Dia. x 1/2" H (3.8 x 1.3 cm)

Vintage Salt & Pepper Caddies

Specifically designed to go with our Vintage Salt & Pepper Shakers, this beautiful caddy is crafted from your choice of acacia or stainless steel for a timeless look. Shakers sold separately.

Acacia Wood

CADDYW Fits GSPR and GSPC S&P Shakers
5" L x 2 1/2" W x 6 3/4" H
(12.7 x 6.4 x 17.1 cm)

Stainless Steel

CADDYSS Fits GSPR and GSPC S&P Shakers
4 3/4" L x 2 1/2" W x 6 5/8" H
(12.1 x 6.4 x 16.8 cm)





Glass Salt & Pepper Shakers

These classically shaped shakers feature paneled glass and chrome or stainless steel tops. Your choice of top style: Petite, Eiffel Tower, Mushroom Cap or Bullet.

- SP125** Petite
½ oz. (14.8 mL)
2" H (5 cm)
- SP126** Eiffel Tower
1 ¼ oz. (37 mL)
4 ½" H (11.4 cm)
- PNS13** Mushroom Cap
1 oz. (29.6 mL)
3" H (7.6 cm)
- PNS24** Mushroom Cap
2 oz. (59.1 mL)
4" H (10.2 cm)
- BPNS115** Bullet
1 ½ oz. (44.4 mL)
3" H (7.6 cm)

TOPPNS1 Replacement Tops for PNS24

Acrylic Salt & Pepper Combo

Save table space with this rectangular two-in-one shaker.

- CPM62** 3 ½ oz. (103.5 mL)
1 ½" Sq. x 6 ½" H
(3.8 x 16.5 cm)



CPM62



Ceramic Salt & Pepper Shaker Sets

In your choice of three contemporary shapes, these simple shakers deliver graphic simplicity.

- CSPT2** Round Tapered
2 ½ oz. (73.9 mL)
1 ¾" Dia. x 3" H (4.4 x 7.6 cm)
- CSPS3** Square
2 ½ oz. (73.9 mL)
3 ¼" Sq. x 3 ⅜" H (8.3 x 8.6 cm)
- CSPRI** Round
2 ½ oz. (73.9 mL)
3 ¼" Dia. x 3 ⅜" H (8.3 x 8.6 cm)
- CCPLUGS** Replacement Stoppers



Ceramic Mason Jar Salt & Pepper Shaker Set

Bring farm-to-table charm to your presentation with these Mason jar-inspired shakers.

- CMSP** 2 oz. (59.1 mL)
1 ½" Dia. x 3" H (3.8 x 7.6 cm)

Porcelain Salt & Pepper Set

The artful simplicity of these teardrop-shaped shakers complements even the most refined table settings.

- PSP2** 2 oz. (59.1 mL)
2" Dia. x 2 ¼" H (5.1 x 5.7 cm)



Porcelain Salt & Pepper Dishes

Incorporate a tactile element into your dinner service by replacing "shake" with "pinch."

- PSLT17** ½ oz. (14.8 mL)
1 ¾" Dia. x ¾" H (4.4 x 1.9 cm)
- PSLT2** 1 oz. (29.6 mL)
2 ⅛" Dia. x 1" H (5.4 x 2.5 cm)





Stainless Steel Salt & Pepper Shaker Sets

This contemporary design can read as futuristic, industrial or just plain stylish depending on the setting.

Silver

SSP2 Brushed Finish
2 oz. (59.1 mL)
1 3/4" Dia. x 2 3/4" H (4.4 x 7 cm)

HMSP2 Hammered Finish
2 oz. (59.1 mL)
1 3/4" Dia. x 2 3/4" H (4.4 x 7 cm)

HMPLUGS Clear Replacement Stoppers

Copper

CSP2 Brushed Finish
2 oz. (59.1 mL)
1 3/4" Dia. x 2 3/4" H (4.4 x 7 cm)

CHSP2 Hammered Finish
2 oz. (59.1 mL)
1 3/4" Dia. x 2 3/4" H (4.4 x 7 cm)

HMPLUGS Clear Replacement Stopper

Black

BHSP2 Hammered Finish
2 oz. (59.1 mL)
1 3/4" Dia. x 2 3/4" H (4.4 x 7 cm)

BHMPUGS Black Replacement Stoppers

Gold

GHSP2 Hammered Finish
2 oz. (59.1 mL)
1 3/4" Dia. x 2 3/4" H (4.4 x 7 cm)

HMPLUGS Clear Replacement Stoppers



Modern Stainless Steel Salt & Pepper Shaker Sets

Choose from funky, whimsical styles in satin-finished stainless steel. Also available in dishwasher-safe black and gold options (color may vary slightly).

Silver

- SPDX33** 3 oz. (88.7 mL)
1" Sq. x 3 3/4" H (2.5 x 9.5 cm)
- DXP4** 2 oz. (59.1 mL)
1" Sq. x 4" H (2.5 x 10.2 cm)
- SPDX11** 4 oz. (118.3 mL)
3 1/8" L x 2 5/8" H (7.9 x 6.7 cm)
- SPDX22** 3 oz. (88.7 mL)
3 1/4" W x 2 5/8" H (8.3 x 6.7 cm)

Gold

- SPDG33** 3 oz. (88.7 mL)
1" Sq. x 3 3/4" H (2.5 x 9.5 cm)
- SPDG11** 4 oz. (118.3 mL)
3 1/8" L x 2 5/8" H (7.9 x 6.7 cm)

Black

- SPDB33** 3 oz. (88.7 mL)
1" Sq. x 3 3/4" H (2.5 x 9.5 cm)
- SPDB11** 4 oz. (118.3 mL)
3 1/8" L x 2 5/8" H (7.9 x 6.7 cm)
- SPPLUGS** Replacement Stoppers



Satin Finish Stainless Steel Salt & Pepper Shaker Set

A stainless steel set for the contemporary scene, these shakers deliver just the right amount of flash.

- SPM4** 3 oz. (88.7 mL)
1 3/4" Dia. x 4" H (4.4 x 10.2 cm)

Brushed Stainless Steel Salt & Pepper Shaker Sets HOT

Give your tabletops a contemporary upgrade with these brushed stainless steel shakers.

- SP29** Round
1 oz. (29.6 mL) 3" H (7.6 cm)
- SP4** Rectangular
2 oz. (59.1 mL) 2 1/2" H (6.4 cm)
- SP35** Round
1 1/2 oz. (44.4 mL) 3 1/2" H (8.9 cm)
- SP6** Round with Caddy
1 oz. (29.6 mL) 3 1/4" H (8.3 cm)



Salt and Pepper Mill Sets

Red

PMSR62 Salt & Pepper Set
6" H (15.2 cm)

PMKNOB Replacement Screw

White

PMSW62 Salt & Pepper Set
6" H (15.2 cm)

PMKNOB Replacement Screw

Bamboo

PMSBA62 Salt & Pepper Set
6" H (15.2 cm)

PMKNOB Replacement Screw

Acrylic

PMSA62 Salt & Pepper Set
6" H (15.2 cm)

PMKNOB Replacement Screw

Presto-Push Pepper Mill

PMG6 6" H (15.2 cm)



Pepper Mills

Stainless Steel

PMSS62 Salt & Pepper Set
6" H (15.2 cm)

PMSS12 Pepper Mill
12" H (30.5 cm)

PMKNOB Replacement Screw

Black

PMSBL62 Salt & Pepper Set
6" H (15.2 cm)

PMBL8 Pepper Mill
8" H (20.3 cm)

PMBL12 Pepper Mill
12" H (30.5 cm)

PMKNOB Replacement Screw

Mahogany

WPMS62 Salt & Pepper Set
6" H (15.2 cm)

WPM8 Pepper Mill
8" H (20.3 cm)

WPM12 Pepper Mill
12" H (30.5 cm)

WPM18 Pepper Mill
18" H (45.7 cm)

PMKNOB Replacement Screw



Shown with WB33 water bottle

USE WITH CLEAR ACRYLIC
WATER BOTTLES ON PG. 348

PRS2

Stainless Steel Salad Dressing Pourer

This easy-to-clean stainless steel pourer is a brilliant way to repurpose our Acrylic Water Bottles. Just fit the plastic cork into the neck and use the bottle to dispense salad dressing or oil. **Sold in a pack of 12.**

PRS2 Fits WB32, WB33, WB34, WB35
2" Dia. x 3 1/4" H (5.1 x 8.3 cm)

Oil & Vinegar Cruets

For something your customers have never seen before, these hand-blown glass designs feature an inner chamber for vinegar and an outer chamber for oil. An ideal accessory for keeping up with the gastronomic fad.

OVJ1 Inner Capacity, 2 oz. (59.1 mL)
Outer Capacity, 10 1/2 oz. (310.5 mL)
2 1/2" Dia. x 6 1/4" H (6.3 x 15.9 cm)

OVJ2 Inner Capacity, 3 oz. (88.7 mL)
Outer Capacity, 13 1/2 oz. (399.2 mL)
3 3/4" Dia. x 5 3/4" H (9.5 x 14.6 cm)

OVJS Replacement Stoppers

OVJ1

OVJ2



Curved Wire Paper Towel Holders

A normally ordinary product made extraordinary with modern, unique styling.

PTCC Stainless Steel
7" Dia. x 13" H (17.8 x 33 cm)

PTBC Black
7" Dia. x 13" H (17.8 x 33 cm)

Contemporary Paper Towel Holders

Two classic table pieces in one smartly designed product.

PTCR Stainless Steel
7" Dia. x 13" H (17.8 x 33 cm)

PTBR Black
7" Dia. x 13" H (17.8 x 33 cm)

Wrought Iron Paper Towel Holder

Durable wrought iron meets a playful wavy design.

THN61 6" Dia. x 12" H (15.2 x 30.5 cm)

Straw Dispenser

Crafted from stainless steel and plastic, this retro straw dispenser is fun to look at and easy to use.

SD3511 3 1/2" Dia. x 10 3/4" H (8.9 x 27.3 cm)





Cake Stand & Cover

Stand is constructed from bright-finished stainless steel. Cover is made of break-resistant heavy clear plastic. Shipped in three pieces.

19SET Base & Cover Set

19001 Stand Only
13 1/2" Dia. x 7 1/2" H (34.3 x 19.1 cm)

19004 Cover Only
12" Dia. x 6" H (30.5 x 15.3 cm)

Stainless Steel Snail Plate, Tong and Fork

SNF700 Snail Fork
7" L (17.8 cm)

SN60 Six-Compartment Plate

SNT612 Satin Finish Snail Tong

Lobster/Nut Crackers

LNC602 Cast Iron, 6 3/8" L (16.2 cm)

LN722 Chrome, 6 3/8" L (16.2 cm)





Stainless Steel Au Gratin Dishes

In multiple sizes, these serving dishes feature timeless design and subtle metalwork.

Round

- AR060** 6 oz. (177.4 mL)
6 3/4" Dia. x 5 1/2" Top ID (17.1 x 14 cm)
- AR080** 8 oz. (236.6 mL)
7 1/4" Dia. x 5 5/8" Top ID (18.4 x 14.3 cm)
- AR100** 10 oz. (295.7 mL)
6 7/8" Dia. x 6" Top ID (17.5 x 15.2 cm)

Oval

- A0080** 8 oz. (236.6 mL)
8 1/8" L x 4 1/4" W x 1 1/4" H (20.6 x 10.8 x 3.2 cm)
- A0120** 12 oz. (354.9 mL)
8 7/8" L x 4 1/2" W x 1 1/4" H (22.5 x 11.4 x 3.2 cm)
- A0150** 15 oz. (443.6 mL)
9 5/8" L x 5" W x 1 1/2" H (24.4 x 12.7 x 3.8 cm)

Counter Setup Menu Holder

Polished heavy-gauge stainless steel. Screws and bracket included.

- CS125** Holder
15 1/2" L x 5" H (39.4 x 12.7 cm)



Butter Warmer

- BWR34** Ceramic Ramekin
4 oz. (118.3 mL)
Stand
3 1/4" Dia. x 3 7/8" H (8.3 x 9.8 cm)
- RAM1** Replacement Ramekin for BWR34
4 oz. (118.3 mL)



AVAILABLE IN TWO SIZES AND
IN THREE COLORS



WISM31

WISW32

WISB33



CTS31

TRSD1815

HOT

Wood Tray Stands

Your servers will appreciate that these elegant tray stands open with one hand, fold for easy storage and hold heavy loads. Featuring nylon straps and real wood.

Mahogany

WISM31 17" W x 31" H (43.2 x 78.7 cm)

WISM38 18" W x 38" H (45.7 x 96.5 cm)
(not shown)

Walnut

WISW32 17" W x 31" H (43.2 x 78.7 cm)

WISW39 18" W x 38" H (45.7 x 96.5 cm)
(not shown)

Black Finish

WISB33 17" W x 31" H (43.2 x 78.7 cm)

WISB40 18" W x 38" H (45.7 x 96.5 cm)
(not shown)

Deluxe Metal Tray Stands HOT

Choose from polished chrome or black chrome plate tubular steel with black nylon straps. Black plastic feet prevent damage to floors.

CTS31 Black Chrome
19 1/2" L x 15" W x 31" H
(49.5 x 38.1 x 78.7 cm)

TRSD1815 Polished Chrome
19 1/2" L x 15" W x 31" H
(49.5 x 38.1 x 78.7 cm)



FITS OVER 27" OVAL TRAYS
AND INSIDE 29" OVAL TRAYS

ATCU

Antimicrobial Oval Tray Cover

Protect an entire tray of food with just one cover. Ingeniously designed to work with the most popular 27" and 29" oval serving trays, this cover helps deliver food safely from kitchen to table while keeping meals warm and free from contaminants. Made of antimicrobial, dishwasher-safe ABS plastic, this cover not only minimizes germs on its surface but also can be safely sanitized after use. The ideal companion for any server.

ATCU 27 7/8" L x 22 1/2" W x 5 5/8" H
(70.8 x 57.2 x 14.3 cm)

Plastic Plate Cover HOT

Made of durable and dishwasher-safe ABS plastic, this plate cover provides full coverage (no finger or steam hole) for safely delivering food to the table. Universal crown on top of cover allows for quick and easy stacking while innovative inside sizing system allows for fit on plates 10 to 11 1/2" (25.4 to 29.2 cm) in diameter.

APCU 11 7/8" Dia. x 2 7/8" H
(30.2 x 7.3 cm)

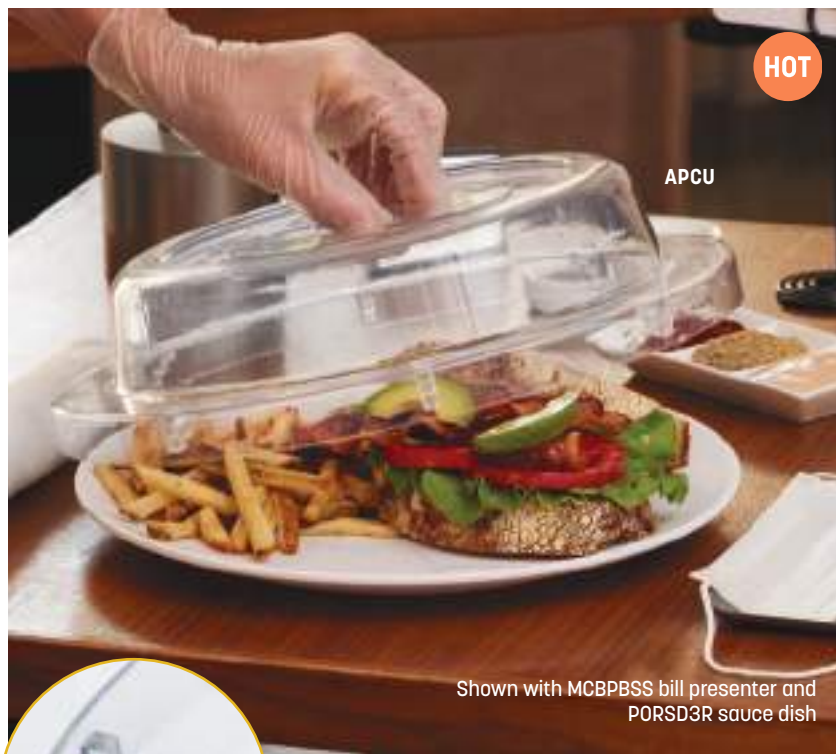

HOT

APCU

Shown with MCBPBSS bill presenter and
PORSD3R sauce dish



CAN COVER AND STACK ON PLATES
10 TO 11 1/2" IN DIAMETER



STANDARD STOCKED PLATE COVERS

Need to please a crowd in a pinch? Our most popular plate covers are now available for rapid turnaround. Made of durable satin-finished stainless steel, these covers feature top-of-the-line heat retention and odor resistance. A well in the top of each cover fits the foot of many different plates. Just measure the diameter of the plate and note the design of the foot to determine the best option. We can also help guide you to the right cover choice with key details about the plate (manufacturer, model and/or size) or by sending a sample plate. All covers are 2" in height and include a finger hole. For help ordering, call 800-333-9133 or email platecovers@amnow.com.

Round Standard Stocked Stainless Steel Plate Covers

| | | | |
|----------------|---|----------------|---|
| PC0600S | Fits plates 5 ⁵ / ₈ " to 6" Dia. (14.3 x 15.2 cm) with Standard or Wide Foot | PC1068S | Fits plates 10 ⁷ / ₁₆ " to 10 ¹ / ₄ " Dia. (26.5 to 27.1 cm) with Narrow Foot |
| PC0688S | Fits plates 6 ³ / ₈ " to 6 ⁷ / ₈ " Dia. (16.8 x 17.5 cm) with Standard, Narrow or Wide Foot | PC1093R | Fits plates 10 ¹ / ₂ " to 10 ⁷ / ₈ " Dia. (26.7 to 27.6 cm) with Standard or Narrow Foot |
| PC0788S | Fits plates 7 ⁵ / ₈ " to 7 ⁷ / ₈ " Dia. (19.4 x 20 cm) with Standard or Narrow Foot | PC1093E | Fits plates 10 ¹ / ₂ " to 10 ⁷ / ₈ " Dia. (26.7 to 27.6 cm) with English-Style or Wide Foot |
| PC0825S | Fits plates 8 ¹ / ₁₆ " to 8 ¹ / ₄ " Dia. (20.5 to 21 cm) with Standard or Wide Foot | PC1112S | Fits plates 11" to 11 ¹ / ₈ " Dia. (27.9 to 28.3 cm) with Standard or Wide Foot |
| PC0875S | Fits plates 8 ³ / ₈ " to 8 ¹³ / ₁₆ " Dia. (21.3 to 22.4 cm) with Standard or Wide Foot | PC1112R | Fits plates 11" to 11 ¹ / ₈ " Dia. (27.9 to 28.3 cm) with Standard or Narrow Foot |
| PC0900S | Fits plates 8 ¹⁵ / ₁₆ " to 9 ¹ / ₈ " Dia. (22.7 to 23.2 cm) with Standard or Wide Foot | PC1150S | Fits plates 11 ¹ / ₈ " to 11 ¹ / ₂ " Dia. (28.3 to 29.2 cm) with Standard or English-Style Foot |
| PC0950R | Fits plates 9 ¹ / ₄ " to 9 ¹ / ₂ " Dia. (23.5 to 24.1 cm) with Standard Foot | PC1175R | Fits plates 11 ⁵ / ₈ " to 11 ³ / ₄ " Dia. (29.5 to 29.8 cm) with Standard Foot |
| PC0988S | Fits plates 9 ⁵ / ₈ " to 9 ⁷ / ₈ " Dia. (24.4 to 25.1 cm) with Standard or English-Style Foot | PC1206R | Fits plates 11 ³ / ₄ " to 12 ¹ / ₁₆ " Dia. (29.8 to 30.6 cm) with Standard Foot |
| PC1025S | Fits plates 10" to 10 ¹ / ₄ " Dia. (25.4 to 26 cm) with Standard or English-Style Foot | PC1244R | Fits plates 12 ¹ / ₈ " to 12 ⁷ / ₁₆ " Dia. (30.8 to 31.6 cm) with Standard Foot |
| PC1062E | Fits plates 10 ³ / ₈ " to 10 ⁵ / ₈ " Dia. (26.4 to 27 cm) with English-Style or Wide Foot | PC1250S | Fits plates 12 ³ / ₁₆ " to 12 ⁹ / ₁₆ " Dia. (31 to 31.9 cm) with Standard, Narrow or Wide Foot |
| PC1068R | Fits plates 10 ⁷ / ₁₆ " to 10 ¹ / ₄ " Dia. (26.5 to 27.1 cm) with Standard Foot | PC1300S | Fits plates 12 ⁵ / ₈ " to 13" Dia. (32 to 33 cm) with Standard, Narrow or Wide Foot |

NEW



Non-Skid Plate Cover Pads

Stack your orders and serve with confidence. These non-skid pads fit on top of plate covers, securing each plate in place during transport. Made of textured silicone for extra resistance. **Sold in a pack of 12.**

SCP65 6 1/2" Dia. (16.5 cm)

SCP8 8" Dia. (20.3 cm)

Plate Cover Plug

Not everyone loves a finger hole. Now there is an easy way to cover the hole of a plate cover for safe, secure transport. Made of durable yet flexible silicone, these plate cover plugs are designed to fit the finger holes of our standard stocked plate covers. **Sold in a pack of 12.**

PCP12 7/8" Dia. (2.2 cm)



PCP12



SCP65 shown with PC0988S plate covers

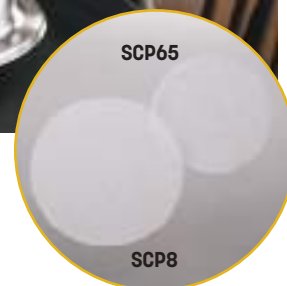

SCP65

SCP8

CUSTOM PLATE COVERS

For more information or to receive a quote, call 800.333.9133 or email platecovers@amnow.com. Sample of plate may be required for evaluation.



CUSTOM PLATE COVERS

For more information or to receive a quote, call 800.333.9133 or email platecovers@amnow.com. Sample of plate may be required for evaluation.



Plate Cover Cart

Aluminum base with five casters. Comes with a steel screw-in bar. Holds up to 175 covers.

SCRACK5 40 ¼" H x 20" Dia. Overall
(102.2 x 50.8 cm)
Pole 37 ¼" H x ½" Dia.
(94.6 x 1.6 cm)
Base 4" H (10.2 cm)

Condiment or Relish Jar Cover

Stainless steel with a deluxe finish. Comes with a heavy riveted stainless knob. Slotted to accommodate dauber spoon.

RD412 Standard size
3 ½" ID (7.94 cm)

RD412



Buffet & Display





SLOW-RELEASE GLASS LID

REVLRD20 shown with REVLRD20BASE

INCLUDES A CONVENIENT SPOON HOLDER

THE EVOLUTION™ COLLECTION

The sharpest, most contemporary designs in the restaurant world need not be limited to the dinner table. The Evolution Collection from American Metalcraft features simple, elegant designs in stainless steel for today's buffets.

Evolution Round Chafer

Chafer features an induction base and comes complete with a stainless steel spoon holder. Stand sold separately.

REVLRD20 7 qt. (6.6 L)
20 ½" L x 20" W x 12" H
(52.1 x 50.8 x 30.5 cm)

Note: For use on induction units greater than 1800 watts.

Replacement Parts

REVLRD20BASE Stand with Fuel Holder
14 ½" L x 17" W x 5 ¾" H
(36.8 x 43.2 x 14.6 cm)

CSR26 Spoon Holder

RFP18RD Round Food Pan

Evolution Rectangular Chafer

Chafer features an induction base and comes complete with a stainless steel spoon holder. Stand sold separately.

REVLRT26 9 qt. (8.5 L)
26" L x 18" W x 12" H
(66 x 45.7 x 30.5 cm)

Note: For use on induction units greater than 1800 watts.

Replacement Parts

REVLRT26BASE Stand with Fuel Holders
22" L x 16" W x 5 ¾" H
(55.9 x 40.6 x 14.6 cm)

CSR26 Spoon Holder

CDFP88 Rectangular Food Pan



REVLRT26 shown with REVLRT26BASE



REVLUICESQ12

Evolution Juice Dispenser

Give brunch a dose of elegance. The polycarbonate body features an offset ice reservoir for easier dispensing and refilling. Legs, lid and frame crafted from sleek stainless steel.

REVLUICESQ12 12 qt. (11.4 L)
 11" L x 12" W x 23 1/8" H
 (27.9 x 30.5 x 58.7 cm)



Replacement Parts

- JFAUC8** Faucet
- JTUBE6** Stainless Steel Ice Tube
- JCOV6** Stainless Steel Cover
- JREP6** Polycarbonate Body



Evolution Coffee Urn

A simple, futuristic design makes this all-stainless steel piece shine. With high-quality faucet and fuel holder.

REVLOSCU12 12 qt. (11.4 L)
 11" L x 13 3/8" W x 21 1/4" H
 (27.9 x 34 x 54 cm)

Replacement Parts

- AFAUC1** Faucet

WARNING: This product can expose you to chemicals including Bisphenol A (BPA), which is known to the State of California to cause birth defects or other reproductive harm. For more information, go to <http://www.P65warnings.ca.gov>. Warning applies to State of California only.

Evolution Beverage Urn

Serve ice-cold juice by day and piping-hot coffee by night with this versatile stainless steel urn. Includes a fuel holder and ice reservoir.

REVLURN12 12 qt. (11.4 L)
 10 1/4" L x 12 5/8" W x 20 7/8" H
 (26 x 32.1 x 53 cm)

Replacement Parts

- AFAUC1** Faucet

Drip Trays

These stainless steel drip trays keep buffet spaces clean without sacrificing aesthetics.

DT3 Round
 5 1/2" Dia. x 1/2" H
 (14 x 1.3 cm)

DT4 Square
 6" Sq. x 1/2" H
 (15.2 x 1.3 cm)

REVLOSCU12



REVLURN12 shown with MICH25 and MICH5 milk cans



COMPLETE THE LOOK WITH EVOLUTION CREAMERS ON PG.120



DT3



DT4

HOT



MESA72C



MESA72H

HOT

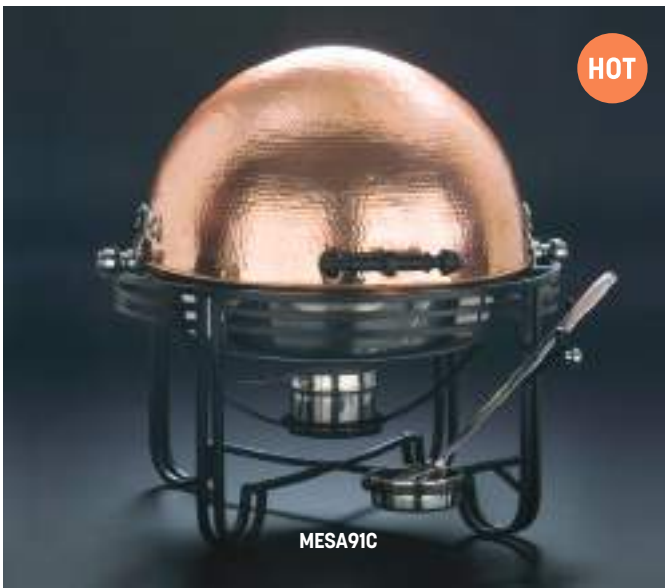

MESA91C



MESA91H

THE MESA™ COLLECTION

Equally elegant and eye-catching, the Mesa Collection is a fabulous way to make your buffet service memorable. Featuring a classic combination of wrought iron and hammered copper or stainless steel, each of these items works independently or as a cohesive collection.

Mesa Hammered Copper Roll-Top Chafers HOT 🔥

These 180° roll-top chafers are adorned with beautiful wrought iron trim and convenient built-in spoon holders. A locking mechanism allows the lid to remain open at 90° for a stunning presentation. Each chafer comes with a 22-gauge food pan, water pan and fuel holder.

MESA91C Round
6 qt. (5.7 L)
19" L x 20" W x 24" H
(48.3 x 50.8 x 61 cm)

MESA72C Rectangular
8 qt. (7.6 L)
27 1/8" L x 21 1/4" W x 19 1/2" H
(68.9 x 54 x 49.5 cm)

Mesa Hammered Stainless Steel Roll-Top Chafers

MESA91H Round
6 qt. (5.7 L)
19" L x 20" W x 24" H
(48.3 x 50.8 x 61 cm)

MESA72H Rectangular
8 qt. (7.6 L)
27 1/8" L x 21 1/4" W x 19 1/2" H
(68.9 x 54 x 49.5 cm)

Replacement Parts

- CDFP44** Round Food Pan
- CDWPM19** Round Water Pan
- CDFP33** Rectangular Food Pan
- CDWPM27** Rectangular Water Pan

Shown with GJ24 square glass jars,
DM10WH mugs and BTS2 condiment rack



MESABUSH13



MESABUCH13

Mesa Coffee Urns

The most stylish way to serve hot beverages. Designed to be paired with a Mesa Roll-Top Chafer.

Silver

MESABUSH13 13 qt. (12.3 L)
14 1/8" Dia. x 23 1/2" H
(35.9 x 59.7 cm)

Copper

MESABUCH13 13 qt. (12.3 L)
14 1/8" Dia. x 23 1/2" H
(35.9 x 59.7 cm)

Replacement Parts

AFAUC1 Faucet



GOLDAGR18



GOLDAGR26



MACD3

Adagio™ Chafers

These stainless steel roll-top chafers can be kept open at any angle. Choose the gold-handled option for an extra luxe flair. Comes complete with a food pan, water pan and fuel holder(s).

Silver-Handled

ADAGIORD18 Round
7 qt. (6.6 L)
18" L x 18 ½" W x 18" H
(45.7 x 47 x 45.7 cm)

ADAGIORT26 Rectangular
9 qt. (8.5 L)
26 ½" L x 19 ½" W x 17 ½" H
(67.3 x 49.5 x 44.5 cm)

Gold-Handled

GOLDAGR18 Round
7 qt. (6.6 L)
18" L x 18 ½" W x 18" H
(45.7 x 47 x 45.7 cm)

GOLDAGR26 Rectangular
9 qt. (8.5 L)
26 ½" L x 19 ½" W x 17 ½" H
(67.3 x 49.5 x 44.5 cm)

Replacement Parts

- RFP18RD** Round Food Pan
- CDWP18** Round Water Pan
- CDFP88** Rectangular Food Pan
- CDWP26** Rectangular Water Pan

Applause™ Chafer

Your crowds will go wild over the satin-finished stainless steel, 90° roll-top rectangular chafer. Comes with standard water pan, food pan and two fuel holders.

MACD3 8 qt. (7.6 L)
24 ½" L x 13 ¾" W x 15 ¼" H
(62.2 x 34.9 x 38.7 cm)

Replacement Parts

- MACTOP** Lid

Chafers Frames

All frames fit standard-sized chafer pans and feature slots for fuel holders. Choose the ornate option for extra style and functionality with spoon holders and side handles. Chafers kits sold separately.

Stackable

SCF2 Wrought Iron Full-Size Frame
24 1/2" L x 16 1/2" W x 8 1/4" H
(62.2 x 41.9 x 21 cm)

Ornate

CF1 Wrought Iron Full-Size Frame & Cup
24" L x 13" W x 11" H
(61 x 33 x 27.9 cm)

Chafers Frame Accessories

CFKIT Food Pan, Water Pan, Lid, (2) Fuel Holders

CDFP55 Food Pan

CDWP66 Water Pan

CDCV77 Lid

Fuel Holder

FH1 Stainless Steel
3 3/4" Dia. x 2 1/2" H, 6 3/4" with Handle
(9.5 x 6.4, 17.1 cm)

Adapter Bars

For dividing water pans into sections.

AB131 12 1/2" L (31.8 cm)

AB211 20 1/2" L (52.1 cm)

Stackable Storage Crate

This large container is especially practical for back-of-house storage. See pairing guide on pg. 456 for fit options.

SCBL 21 1/4" L x 17 5/8" W x 18 1/8" H
(54 x 44.8 x 46 cm)





Folding Beverage Frames

Upgrade buffets in an instant with these collapsible frames. Use with food pans or beverage inserts, and then fold and stack for easy storage. In your choice of size and style.

Black Twilight Crates

- KBC6** 1/6-Size
6 1/4" L x 5 3/4" W x 6 1/2" H
(15.9 x 14.6 x 16.2 cm)
- KBC12** 1/3-Size
12" L x 6 1/8" W x 6 3/8" H
(30.5 x 15.6 x 16.2 cm)
- KBC10** Half-Size
12 1/8" L x 10" W x 8 1/8" H
(30.8 x 25.4 x 20.6 cm)
- KBC20** Full-Size
20 3/8" L x 12 3/8" W x 8 1/4" H
(51.8 x 31.4 x 21 cm)



Stainless Steel Milk Crates

- KSMC6** 1/6-Size
6 1/4" L x 5 3/4" W x 6 1/2" H
(15.9 x 14.6 x 16.5 cm)
- KSMC12** 1/3-Size
12" L x 6 1/8" W x 6 3/8" H
(30.5 x 15.6 x 16.2 cm)
- KSMC10** Half-Size
12 1/8" L x 10" W x 8 1/8" H
(30.8 x 25.4 x 20.6 cm)
- KSMC20** Full-Size
20 1/4" L x 12 3/8" W x 8 1/4" H
(51.4 x 31.4 x 21 cm)



Shown with G30, G21 and G17 griddles, BLHT1 and BLHT2 tongs, and MPL8 mini pots



Shown with G30, G21 and G17 griddles, HM8TNG tongs, BD45 balti dishes, HCHS1 card holder and TAGA6WT chalk card



Twilight Griddle Stands

Elevate your brunch presentation with this trio of griddle stands. All three are crafted from stainless steel so they can stand the heat in style. Tapered for easy storage.

Black

- GSC16** Half-Size
16" L x 8" W x 4 ½" H
(40.6 x 20.3 x 11.4 cm)
- GSC17** Round
17" Dia. x 4 ½" H
(43.2 x 11.4 cm)
- GSC26** Full-Size
26 ¼" L x 14" W x 4 ½" H
(66.7 x 35.6 x 11.4 cm)

Silver

- SGSC16** Half-Size
16" L x 8" W x 4 ½" H
(40.6 x 20.3 x 11.4 cm)
- SGSC17** Round
17" Dia. x 4 ½" H
(43.2 x 11.4 cm)
- SGSC26** Full-Size
26 ¼" L x 14" W x 4 ½" H
(66.7 x 35.6 x 11.4 cm)



Black Twilight Market Trays

Give your deli case an easy, stylish upgrade. A striking angular design gives these dishwasher-safe market trays a contemporary flair.

MTB296 Rectangular
29 3/4" L x 6 1/8" W x 2" H
(75.6 x 15.6 x 5.1 cm)

MTB298 Rectangular
29 3/4" L x 8 1/2" W x 2" H
(75.6 x 21.6 x 5.1 cm)

MTB2910 Rectangular
29 3/4" L x 10 1/2" W x 2" H
(75.6 x 26.7 x 5.1 cm)

MTB156 Rectangular
15" L x 6" W x 2" H
(38.1 x 15.2 x 5.1 cm)

MTB159 Rectangular
15" L x 9" W x 2" H
(38.1 x 22.9 x 5.1 cm)

MTB1512 Rectangular
15" L x 12" W x 2" H
(38.1 x 30.5 x 5.1 cm)

SBBL Rectangular
16 3/8" L x 8 1/4" W x 2" H
(41.6 x 21 x 5.1 cm)

SBBS Square
8 1/8" Sq. X 2" H
(20.6 x 5.1 cm)

Rubberized Wedges NEW

Level up your display - literally - with these handy rubberized wedges! The rubberized coating allows you to prop up crates and trays for full display. Available in different heights for different needs.

DWRB2 5" L x 3" W x 2 1/2" H
(12.7 x 7.6 x 6.4 cm)

DWRB5 5" L x 5" W x 5" H
(12.7 x 12.7 x 12.7 cm)
(not shown)

Ultra-Chill Cold Cell NEW

Keep food colder for longer. These cells freeze at 10° F and maintain cold temperatures up to four hours. Recharge in freezer for 24 hours.*

COLD8 8" Sq. x 1 7/8" H
(20.3 x 4.8 cm)



Shown with COLD8 cold cell and POR9 bowl



PROP UP TRAYS WITH RUBBERIZED WEDGES



COLD CELL MUST MAINTAIN SURFACE-TO-SURFACE CONTACT FOR BEST PERFORMANCE

*The performance of the cold cell will vary based on food types, environmental temperature and humidity and other external variables.



G30 shown on
GSST2514 stand

G17 shown on
GSSS20 stand

Marinated
Vegetables

HAMMERED STAINLESS STEEL GRIDDLES AND STANDS

These gorgeous pieces lend a sparkling touch to any buffet. Each of these warming griddles is individually hammered, making no two alike. Pair them with matching contemporary stainless steel stands to complete the exquisite look.

Large Rectangular Griddle and Stand

G30 Griddle
30 ¾" L x 16 ¼" W x 1 ¾" H
(78.1 x 41.3 x 4.4 cm)

GSST2514 Stand
26 ¼" L x 14" W x 4 ¼" H
(66.7 x 35.6 x 10.8 cm)

Round Griddle and Stand

G17 Griddle
18" Dia. x 2" H
(45.7 x 5.1 cm)

GSSS20 Stand
17" Dia. x 4 ¼" H
(43.2 x 10.8 cm)

G30

G17



Oval Griddle and Stand

G23 Griddle
23 ¾" L x 13 ¾" W x 1 ¾" H
(60.3 x 34.9 x 4.4 cm)

GSOVL Stand
20" L x 14" W x 4 ¾" H
(50.8 x 35.6 x 12.1 cm)

Small Rectangular Griddle and Stand

G21 Griddle
21 ¾" L x 9" W x 1 ½" H
(55.2 x 22.9 x 3.8 cm)

GSREC Stand
17 ¼" L x 9 ¼" W x 5" H
(43.8 x 23.5 x 12.7 cm)

Paella Pan and Stand

GP21 Paella Pan
21 ¾" Dia. x 4 ¾" H
(55.2 x 12.1 cm)

GSSS20 Stand
17" Dia. x 4 ¼" H
(43.2 x 10.8 cm)



Stainless Steel Griddles and Stands

Round Griddle and Stand

GSST17 Griddle
17 1/2" Dia. x 2 1/8" H
(44.5 x 5.4 cm)

GSSS20 Stand
17" Dia. x 4 1/4" H
(43.2 x 10.8 cm)

Rectangular Griddle and Stand

GSSS1526 Griddle
32 5/8" L x 16 1/2" W x 2 1/8" H
(82.9 x 41.9 x 5.4 cm)

GSST2514 Stand
26 1/4" L x 14" W x 4 1/4" H
(66.7 x 35.6 x 10.8 cm)

Flame Guards

FGRS7 7" Dia. x 3 1/2" H
(17.8 x 8.9 cm)

FGRS10 10" Dia. x 3 1/2" H
(25.4 x 8.9 cm)



GSST17 shown with
GSSS20 stand



GSSS1526 shown with
GSST2514 stand



FGRS10 shown with
GSSS1526 griddle and
GSST2514 stand

FGRS7 shown with
GS1775 paella pan
and GSS17 stand

LASER-CUT FLAMES
EMBELLISH THESE
BRUSHED STAINLESS
STEEL GUARDS THAT
PROTECT FUEL CANS
FROM WIND



GS1775 shown
with GSS17 stand

Wrought Iron Griddles and Stands

These griddles and stands are perfect for self-served breakfast, globally-inspired fare, tempting desserts and more.

Round Paella Pan and Stand

GS1775 Paella Pan
21 3/4" Dia. x 4 3/4" H
(55.2 x 12.1 cm)

GSS17 Stand
17" Dia. x 4 1/4" H
(43.2 x 10.8 cm)

Round Griddle and Stand

GS18 Round Griddle with Stand
18" Dia. x 4 1/4" H
(45.7 x 10.8 cm)

GS81 Griddle
18" Dia. x 1" H
(45.7 x 2.5 cm)

GSS17 Stand
17" Dia. x 4 1/4" H
(43.2 x 10.8 cm)

Rectangular Griddles and Stands

GS27 Full-Size Griddle with Stand
27" L x 16" W x 5" H
(68.6 x 40.6 x 12.7 cm)

GS16 Half-Size Griddle with Stand (not shown)
16" L x 13 1/2" W x 5" H
(40.6 x 34.3 x 12.7 cm)

G72 Full-Size Griddle
27" L x 16" W x 1" H
(68.6 x 40.6 x 2.5 cm)

G61 Half-Size Griddle (not shown)
16" L x 13 1/2" W x 1" H
(40.6 x 34.3 x 2.5 cm)



GS18



GS27



CAST IRON

Heavy-duty cast iron goes straight from oven to table and looks great at stations and buffets. In a variety of styles and sizes to accommodate the trendy rustic look.

Round Cast Iron Fry Pans

- CIS8** 48 oz. (1.4 L)
8" Dia. x 2 ¼" H
13 ¾" L with Handle
(20.3 x 5.7, 35 cm)
- CIS10** 64 oz. (1.9 L)
10" Dia. x 2 ¼" H
15 ¾" L with Handle
(25.4 x 5.7, 40 cm)
- CIS12** 96 oz. (2.8 L)
12" Dia. x 2 ¼" H
19" L with Handle
(30.5 x 5.7, 48.3 cm)
- CIS14** 128 oz. (3.8 L)
14" Dia. x 3 ½" H
20" L with Handle
(35.6 x 8.9, 50.8 cm)

Large Cast Iron Casseroles

- CIPO3** 96 oz. (2.8 L)
10 ⅝" L x 8 ⅛" W x 4 ½" H
12 ½" L with Handles, 6 ½" H with Knob
(27 x 20.6 x 11.4, 31.8, 16.5 cm)
- CIPO4** 128 oz. (3.8 L)
11 ⅝" L x 8 ¼" W x 4 ½" H
14" L with Handles, 6 ½" H with Knob
(29.5 x 21 x 11.4, 35.6, 16.5 cm)
- CIPR3** 96 oz. (2.8 L)
8 ¾" Dia. x 4" H
11 ¼" L with Handles, 6" H with Knob
(22.2 x 10.2, 28.6, 15.2 cm)
(not shown)
- CIPR4** 128 oz. (3.8 L)
9 ½" Dia. x 4 ¼" H
12" L with Handles, 6 ½" H with Knob
(24.1 x 10.8, 30.5, 16.5 cm)
(not shown)



Large Silicone Trivets

- TRVR8** Round
8" Dia. x ¼" H
(20.3 x 0.6 cm)
- TRVR10** Round
10" Dia. x ¼" H
(25.4 x 0.6 cm)



Mini Fry Pans and Casseroles

- CIPRT5336** 9 ½ oz. (280.9 mL)
5 ⅜" L x 3 ⅝" W x 1 ⅝" H, 7" L with Handles
(13.7 x 9.2 x 4.1, 17.8 cm)
- CIPS61** 9 ½ oz. (280.9 mL)
5 ¾" Sq. x ⅞" H, 7 ⅞" L with Handles
(14.6 x 2.2, 18.1 cm)
- CIS41** 3 ½ oz. (103.5 mL)
3 ⅞" Dia. x 1" H, 6 ⅞" L with Handle
(9.8 x 2.5, 17.5 cm)
- CIS51** 8 ½ oz. (251.4 mL)
5" Dia. x 1 ½" H, 8 ¼" L with Handle
(12.7 x 3.8, 21 cm)
- CIS61** 15 ½ oz. (458.4 mL)
6 ¼" Dia. x 1 ¼" H, 10" L with Handle
(15.9 x 3.2, 25.4 cm)



Mini Round Casseroles and Pots

- CIPR5125** 8 ½ oz. (251.4 mL)
5" Dia. x 1 ¼" H, 6 ½" L with Handles
(12.7 x 3.2, 16.5 cm)
- CIPR6250** 19 oz. (561.9 mL)
6 ¼" Dia. x 1 ½" H, 8 ¾" L with Handles
(15.9 x 3.8, 22.2 cm)
- CIPR7251** 27 oz. (798.5 mL)
7 ¼" Dia. x 1 ¾" H, 9 ⅝" L with Handles
(18.4 x 4.4, 24.5 cm)
- CIPR42** 9 oz. (266.2 mL)
4" Dia. x 2" H, 5 ⅝" L with Handles
3" H with Knob
(12.7 x 5.1, 14.3, 6 cm)
- CIPR5500** 19 oz. (561.9 mL)
5" Dia. x 2 ¼" H, 6 ½" L with Handles
3 ¾" H with Knob
(12.7 x 5.7, 16.5, 9.5 cm)
- CIPR5526** 27 oz. (798.5 mL)
5 ½" Dia. x 2 ⅝" H, 7 ⅝" L with Handles
4" H with Knob
(14 x 6.6, 19.4, 10.2 cm)



Mini Oval Casseroles and Pots

- CIPOV856** 27 oz. (798.5 mL)
8 ½" L x 6" W x 1 ¾" H, 10 ⅞" L with Handles
(21.6 x 15.2 x 4.5, 27.6 cm)
- CIPOV9567** 36 ½ oz. (1.1 L)
9 ½" L x 6 ⅝" W x 2" H, 12" L with Handles
(24.1 x 16.2 x 5.1, 30.5 cm)
- CIPOV63** 11 ½ oz. (340.1 mL)
5" L x 2 ⅝" W x 2" H, 6 ½" L with Handles
3" H with Knob
(12.7 x 6.7 x 5, 16.5, 7.6 cm)
- CIPOV6040** 17 ½ oz. (517.5 mL)
6" L x 4" W x 2 ½" H, 7 ½" L with Handles
3 ⅞" H with Knob
(15.2 x 10.2 x 6.4, 19.1, 9.8 cm)
- CIPOV745** 23 ½ oz. (695 mL)
7" L x 4 ½" W x 2 ¼" H, 8 ½" L with Handles
4" H with Knob
(17.8 x 11.4 x 5.7, 21.6, 10.2 cm)



Mini Griddle

- CIG85** 8 ¼" L x 5 ¾" W x ¾" H, 9 ½" L with Handles
(21 x 14.6 x 1.9, 24.1 cm)



Mix-and-Match Juice Dispensers

These pieces are all stylishly interchangeable. Just choose a body and a base, and create a unique look that's as refreshing as the beverages you're serving. Bodies come complete with faucet, cover, ice tube and insert.

STEP 1
Pick a Body Size

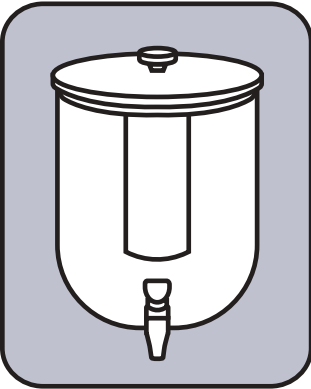

+

STEP 2
Pick a Base.

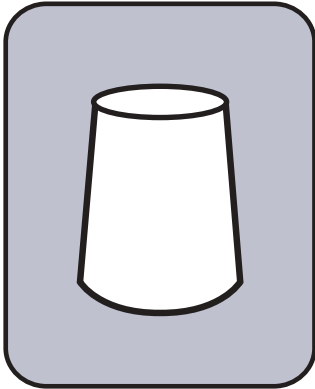

=

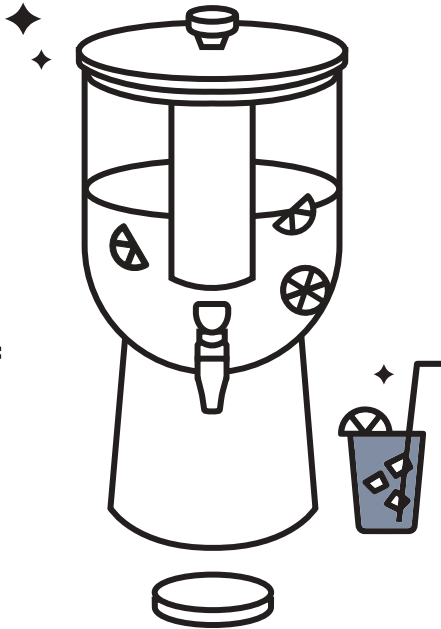

JBASE1 shown with JUICE4



JBASE7 shown with JUICE3





Tritan Plastic Dispenser Bodies

- JUICE3** Body, 12 qt. (11.4 L)
11" L x 10 1/4" W x 13 1/2" H
(27.9 x 26 x 34.3 cm)
- JUICE4** Body, 20 qt. (18.9 L)
12 1/2" L x 12" W x 20 1/2" H
(31.8 x 30.5 x 52.1 cm)

Dispenser Bases

- JBASE1** Hammered Stainless Steel Base
8" Dia. x 7 3/4" H (20.3 x 19.7 cm)
- JBASE2** Wrought Iron Juice Base
8" Dia. x 8" H (20.3 x 20.3 cm)
- JBASE5** Black Twilight Base
8" Dia. x 8" H (20.3 x 20.3 cm)
- JBASE6** Black Twilight Base
9" Dia. x 12" H (22.9 x 30.5 cm)
- JBASE7** Hammered Stainless Steel Base
9" Dia. x 12" H (22.9 x 30.5 cm)
- JBASEMEL8** Acacia/Marble Melamine Base
11 1/4" Dia. x 7 3/4" H (28.6 x 19.7 cm)

Replacement Parts for JUICE3

- JFAUC5** Faucet
- JCOV3** Stainless Steel Cover
- JTUBE3** Stainless Steel Ice Tube with Inset
- JREP4** Plastic Body with Faucet

Replacement Parts for JUICE4

- JFAUC5** Faucet
- JCOV4** Stainless Steel Cover
- JTUBE4** Stainless Steel Ice Tube with Inset
- JREP5** Plastic Body with Faucet





JBASEA8 shown with **JUICE6**

NEW



TOP DISPENSER CAN BE USED ON ITS OWN

Stacking Dual Juice Dispenser **NEW**

Serve up two beverage choices at the same time with this cleverly designed stacking juice dispenser. Made of extra strong polycarbonate, each section offers ample capacity for your largest crowds. Use them together or use the top dispenser on its own for a different look. Pair with bases in different finishes to create a look perfectly suited to your venue.

JUICE6 Dispensers (1) 9.5 qt. (9 L) and (1) 15 qt. (14.2 L)
 11 3/4" L x 9 3/4" W x 25 3/4" H
 (29.8 x 24.8 x 65.4 cm)



JBASEM9 shown with **JUICE6**

NEW

Acacia Wood Juice Dispenser Base **NEW**

Add a rustic touch to your beverage station with this attractive acacia wood juice base! Space-saving knockdown design allows for easy storage.

JBASEA8 Fits with **JUICE6**
 11 7/8" L x 11 7/8" W x 7 3/4" H
 (30.2 x 30.2 x 19.7 cm)

Upton Collection Juice Dispenser Base **NEW**

This juice dispenser base has a rich espresso color that adds timeless splendor to any buffet. Built in metal liner protects wood from potential moisture.

JBASEM9 Fits with **JUICE6**
 11" Dia. x 8 7/8" H
 (27.9 x 22.5 cm)

WARNING: This product can expose you to chemicals including Bisphenol A (BPA), which is known to the State of California to cause birth defects or other reproductive harm. For more information, go to www.P65warnings.ca.gov. Warning applies to State of California only.

Dual Juice Dispenser ⚠️

This clever, doubly functional piece comes complete with polycarbonate body, faucets, cover, ice tubes and grated base.

JUICE12 Dispensers (2) 5.3 qt. (5 L)
17" L x 13 1/2" W x 21" H
(43.2 x 34.3 x 53.3 cm)

Replacement Parts

JFAUC8 Faucet
JSTRN12 Strainer
JCOV12 Cover
JTUBE12 Dual Ice Tubes
JBOD12 Dual Polycarbonate Bodies

**Mini Juice Dispenser** ⚠️

Comes complete with polycarbonate body, faucet, cover, ice tube and grated base.

JUICE5 Dispenser, 5.3 qt. (5 L)
16" L x 9" W x 14" H
(40.6 x 22.9 x 35.6 cm)

Replacement Parts

JSTRN8 Strainer
JCOV8 Cover
JFAUC8 Faucet
JTUBE8 Ice Tube
JBOD5 Polycarbonate Body



JUICE12



JUICE5



WARNING: This product can expose you to chemicals including Bisphenol A (BPA), which is known to the State of California to cause birth defects or other reproductive harm. For more information, go to www.P65warnings.ca.gov. Warning applies to State of California only.



Juice Dispensers

Retro and sleek, these pieces come with polycarbonate bodies, faucets, covers, ice tubes and grated bases.

JUICE1 Dispenser, 8 ½ qt. (8 L)
14 ¼" L x 10 ¼" W x 22" H
(36.2 x 26 x 55.9 cm)

JUICE2 Dispensers, (2) 8 ½ qt. (8 L)
20" L x 10 ¼" W x 22" H
(50.8 x 26 x 55.9 cm)

Replacement Parts

- JSTRN6** Strainer
- JCOV1** Cover
- JTUBE5** Stainless Steel Ice Tube
- JFAUC4** Faucet
- JREP3** Polycarbonate Body



WARNING: This product can expose you to chemicals including Bisphenol A (BPA), which is known to the State of California to cause birth defects or other reproductive harm. For more information, go to www.P65warnings.ca.gov. Warning applies to State of California only.



Allegro Coffee Urns

These 12 qt. (11.4 L) stainless steel urns feature a stylish faucet and a fuel holder. 11 1/8" Dia. x 19 3/4" H (28.3 x 50.2 cm).

ALLEGUCU1 Gold Legs

ALLEGUCU2 Stainless Steel Legs

Allegro Coffee Urn Accessories

AFAUC1 Faucet

Drip Trays

These stainless steel drip trays keep buffet spaces clean without sacrificing aesthetics.

DT3 Round
5 1/2" Dia. x 1/2" H (14 x 1.3 cm)

DT4 Square
6" Sq. x 1/2" H (15.2 x 1.3 cm)





Vintage Hammered Buffetware

Make a statement with our vintage finish buffetware. Elevate your next buffet service with these classically inspired accessories. Will patina with use. Color may vary slightly.

Black

- BLHT6** 6" L Serving Tongs (15.2 cm)
- BLHT1** 9" L Serving Tongs (22.9 cm)
- BLHP10** 10" L Pie Server (25.4 cm)
- BLHF10** 10" L Cold Meat Fork (25.4 cm)
- BLHSS10** 10" L Slotted Spoon (25.4 cm)
- BLHSP10** 10" L Solid Spoon (25.4 cm)
- BLHML** 1 ½ oz., 11 ½" L Ladle (44.4 mL, 29.2 cm)
- BLHT2** 11 ¾" L Serving Tongs (29.8 cm)
- BLHSS** 13 ¼" L Slotted Spoon (33.7 cm)
- BLHSP** 13 ¼" L Solid Spoon (33.7 cm)
- BLHSA10** ½ oz., 9 ⅜" L Salad Spoon (14.8 mL, 23.8 cm)
- BLHSP6** 6 ⅝" L Spreader (16.8 cm)

Bronze

- BVHT6** 6" L Serving Tongs (15.2 cm)
- BVHT1** 9" L Serving Tongs (22.9 cm)
- BVHP10** 10" L Pie Server (25.4 cm)
- BVHF10** 10" L Cold Meat Fork (25.4 cm)
- BVHSS10** 10" L Slotted Spoon (25.4 cm)
- BVHSP10** 10" L Solid Spoon (25.4 cm)
- BVHML** 1 ½ oz., 11 ½" L Ladle (44.4 mL, 29.2 cm)
- BVHT2** 11 ¾" L Serving Tongs (29.8 cm)
- BVHSS** 13 ¼" L Slotted Spoon (33.7 cm)
- BVHSP** 13 ¼" L Solid Spoon (33.7 cm)
- BVHL** 3 ½ oz., 13" L Ladle (103.5 mL, 33 cm)
- BVHF** 13" L Cold Meat Fork (33 cm)
- BVHSA10** ½ oz., 9 ⅜" L Salad Spoon (14.8 mL, 23.8 cm)
- BVHSP6** 6 ⅝" L Spreader (16.8 cm)



-  Black (BL)
-  Stainless Steel (SV)
-  Bronze (BV)
-  Wavy Aged (WV)
-  Gold (GV)

Available in five classic finishes

DISHWASHER-SAFE
VIBRANT COLOR

Gold

- GVHT6** 6" L Serving Tongs (15.2 cm)
- GVHT1** 9" L Serving Tongs (22.9 cm)
- GVHP10** 10" L Pie Server (25.4 cm)
- GVHF10** 10" L Cold Meat Fork (25.4 cm)
- GVHSS10** 10" L Slotted Spoon (25.4 cm)
- GVHSP10** 10" L Solid Spoon (25.4 cm)
- GVHML** 1½ oz., 11½" L Ladle (44.4 mL, 29.2 cm)
- GVHT2** 11¾" L Serving Tongs (29.8 cm)
- GVHSS** 13¼" L Slotted Spoon (33.7 cm)
- GVHSP** 13¼" L Solid Spoon (33.7 cm)
- GVHL** 3½ oz., 13" L Ladle (103.5 mL, 33 cm)
- GVHF** 13" L Cold Meat Fork (33 cm)
- GVHSA10** ½ oz., 9¾" L Salad Spoon (14.8 mL, 23.8 cm)
- GVHSP6** 6⅝" L Spreader (16.8 cm)



Stainless Steel

- SVHT6** 6" L Serving Tongs (15.2 cm)
- SVHT1** 9" L Serving Tongs (22.9 cm)
- SVHP10** 10" L Pie Server (25.4 cm)
- SVHF10** 10" L Cold Meat Fork (25.4 cm)
- SVHSS10** 10" L Slotted Spoon (25.4 cm)
- SVHSP10** 10" L Solid Spoon (25.4 cm)
- SVHML** 1½ oz., 11½" L Ladle (44.4 mL, 29.2 cm)
- SVHT2** 11¾" L Serving Tongs (29.8 cm)
- SVHSS** 13¼" L Slotted Spoon (33.7 cm)
- SVHSP** 13¼" L Solid Spoon (33.7 cm)
- SVHL** 3½ oz., 13" L Ladle (103.5 mL, 33 cm)
- SVHF** 13" L Cold Meat Fork (33 cm)
- SVHSA10** ½ oz., 9¾" L Salad Spoon (14.8 mL, 23.8 cm)
- SVHSP6** 6⅝" L Spreader (16.8 cm)

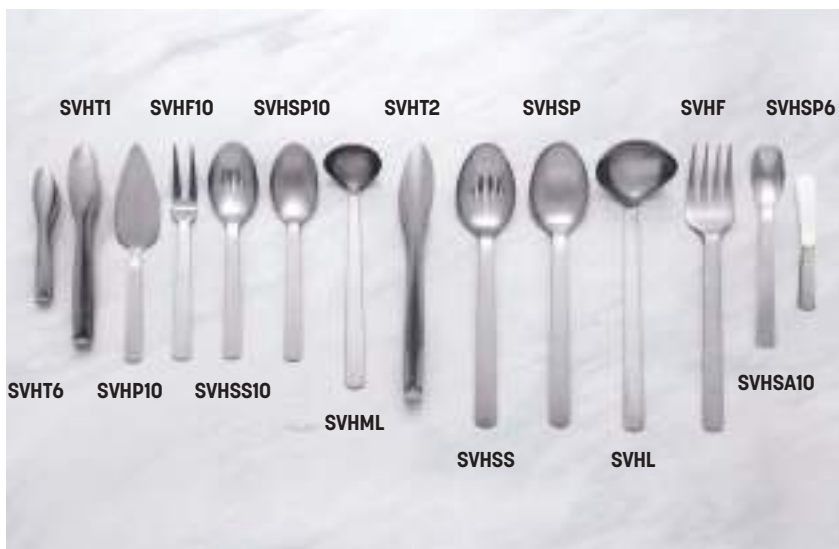

Wavy Aged Stainless Steel

- WVAT6** 6" L Serving Tongs (15.2 cm)
- WVAT1** 9" L Serving Tongs (22.9 cm)
- WVAP10** 10" L Pie Server (25.4 cm)
- WVAF10** 10" L Cold Meat Fork (25.4 cm)
- WVASS10** 10" L Slotted Spoon (25.4 cm)
- WVASP10** 10" L Solid Spoon (25.4 cm)
- WVAML** 1½ oz., 11½" L Ladle (44.4 mL, 29.2 cm)
- WVAT2** 11¾" L Serving Tongs (29.8 cm)
- WVASS** 13¼" L Slotted Spoon (33.7 cm)
- WVASP** 13¼" L Solid Spoon (33.7 cm)
- WVAL** 3½ oz., 13" L Ladle (103.5 mL, 33 cm)
- WVAF** 13" L Cold Meat Fork (33 cm)
- WVASA10** ½ oz., 9¾" L Salad Spoon (14.8 mL, 23.8 cm)
- WVASP6** 6⅝" L Spreader (16.8 cm)





EACH PIECE FEATURES
ONE-OF-A-KIND HANDMADE
WORKMANSHIP

Amano Buffetware NEW

The Amano Collection is the perfect union of contemporary flair and handmade workmanship. Each piece is hand forged of durable stainless steel for a unique yet sophisticated look.

- SHFT6** 6 3/8" L Serving Tongs (16.2 cm)
- SHFT9** 9" L Serving Tongs (22.9 cm)
- SHFT11** 11 3/4" L Serving Tongs (29.8 cm)
- SHFF12** 12" L Cold Meat Fork (30.5 cm)
- SHFSP11** 11" L Pastry Server (27.9 cm)
- SHFL9** 1 oz., 9" L Ladle (29.6 mL, 22.9 cm)
- SHFSA9** 3/4 oz., 9 3/8" L Salad Spoon (22.2 mL, 23.8 cm)
- SHFSS12** 12" L Slotted Spoon (30.5 cm)
- SHFSP12** 12" L Solid Spoon (30.5 cm)
- SHFSP7** 7" L Spreader (17.8 cm)



Hammered Buffet Portioned Servers

With size-marked handles, these pieces are perfect wherever nutritional requirements need to be met.

HMMS18 1/8-Cup, 11 1/2" L Overall (29.6 mL, 29.2 cm)

HMMS14 1/4-Cup, 12" L Overall (59.1 mL, 30.5 cm)

HMMS13 1/3-Cup, 12 3/4" L Overall (78.8 mL, 32.4 cm)

HMMS12 1/2-Cup, 13" L Overall (118.3 mL, 33 cm)

HMMS10 1 Cup, 14" L Overall (236.6 mL, 35.6 cm)

Hammered Buffetware

Hammered stainless steel and inspired designs are time-honored ways of dressing up any buffet.

HM6TNG 6" L Serving Tongs (15.2 cm)

HM8TNG 8" L Serving Tongs (20.3 cm)

HM11CMF 11" L Cold Meat Fork (27.9 cm)

HM11FK 11" L Two-Tined Fork (27.9 cm)

HM12PAS 11" L Pastry Server (27.9 cm)

HM14KN 14" L Serrated Knife (35.6 cm)

HM1LAD 1 oz., 9" L Ladle (29.6 mL, 22.9 cm)

HM9SPN 1/4 oz., 9 1/2" L Salad Spoon (7.4 mL, 24.1 cm)

HM12SL 12" L Slotted Spoon (30.5 cm)

HM12SOL 12" L Solid Spoon (30.5 cm)

HM12NOT 12" L Notched Spoon (30.5 cm)

HM10SPO 10" L Solid Spoon (25.4 cm)

HM10SL 10" L Slotted Spoon (25.4 cm)





SW12PAS

SW6TNG

SW9TNG

SWILAD

SW9SPN



SW10SPO

SW12SOL

SW12SL

ITS6

PTS9

PTC8

Mirage™ Buffetware

These stainless steel serving pieces come in an extensive collection for exceptional presentation consistency.

- SW12PAS** 11" L Pastry Server (27.9 cm)
- SW6TNG** 6" L Tongs (15.2 cm)
- SW9TNG** 9" L Tongs (22.9 cm)
- SWILAD** 1 oz., 9" L Ladle (29.6 mL, 22.9 cm)
- SW9SPN** ½ oz., 9 ½" L Salad Spoon (14.8 mL, 24.1 cm)
- SW10SPO** 10" L Solid Spoon (25.4 cm)
- SW12SOL** 12" L Solid Spoon (30.5 cm)
- SW12SL** 12" L Slotted Spoon (30.5 cm)
- ITS6** 6" L Ice Tongs (15.2 cm)
- PTS9** 8" L Serving Tongs (20.3 cm)
- PTC8** 8" L Pasta Tongs (20.3 cm)



Belaire™ Hollow Handle Buffetware

This collection features mirror-finished stainless steel, one-piece hollow handle construction and an ergonomic finger grip design.

- SLL1** 1 oz., 11" L Spout Ladle
(29.6 mL, 27.9 cm)
- SLL2** 2 oz., 12" L Spout Ladle
(59.1 mL, 30.5 cm)
- SPT14** 14" L Perforated Turner
(35.6 cm)
- SPS11** 11" L Pie Server
(27.9 cm)
- SLP121** 12" L Slotted Spoon
(30.5 cm)
- SSP120** 12" L Solid Spoon
(30.5 cm)
- SLL6** 6 oz., 12" L Ladle
(177.4 mL, 30.5 cm)
- SLL4** 4 oz., 12" L Ladle
(118.3 mL, 30.5 cm)





TONG3



TONG2

Salad Scissor Tongs

TONG3 Tong, Spoon/Spatula Design
10" L (25.4 cm)

TONG2 Tong, Spoon/Three-Tine Fork Design
10" L (25.4 cm)



TG8

TGP8

Serving Tongs

TG8 Solid
8 1/2" L x 2 1/2" W x 2 1/2" H
(21.6 x 6.4 x 6.4 cm)

TGP8 Perforated
8 1/2" L x 2 1/2" W x 2 1/2" H
(21.6 x 6.4 x 6.4 cm)

Evolution Stainless Steel Tongs

Designed with ergonomics and contemporary design in mind, these tongs come in a range of sizes for every use.

TGS8 7 1/4" L (18.4 cm)

TGS6 6" L (15.2 cm)

TGS9 9 1/2" L (24.1 cm)

TGS12 12" L (30.5 cm)



TGS8



TGS6

TGS9

TGS12

Evolution Cheese Knives

Clean lines and satin stainless steel make these knives the most stylish way to serve all manner of cheeses.

- CKNF6** Hard Cheese Knife
9" L (22.9 cm)
- CKNF3** Fork-Tipped Hard Cheese Knife
9" L (22.9 cm)
- CKNF5** Soft Cheese Knife
9" L (22.9 cm)
- CKNF4** Hard Cheese Knife
5 ¼" L (13.3 cm)
- CKNF7** Soft Cheese Spreader
6 ⅝" L (16.8 cm)
- CKNF1** Flat Cheese Knife
5 ¼" L (13.3 cm)
- CKNF2** Semi-Hard Cheese Knife
5 ¼" L (13.3 cm)
- CKNF8** Hard Cheese Fork
5 ¼" L (13.3 cm)



Olive Wood Cheese Knives

Beautifully grained olive wood handles provide contrast to the mirror-finished stainless blades of these expertly crafted cheese knives. Pair with an Olive Wood Serving Board to complete the look.

- CKOW7** Soft Cheese Spreader
5" L (12.7 cm)
- CKOW3** Hard Cheese Knife
6" L (15.2 cm)
- CKOW2** Semi-Hard Cheese Knife
4 ¾" L (12.1 cm)
- CKOW4** Hard Cheese Knife
5" L (12.7 cm)
- CKOW8** Hard Cheese Fork
5" L (12.7 cm)
- CKOW1** Hard Cheese Knife
5" L (12.7 cm)





CER19

CER21

CER23



CER15



THE PRESTIGE™ CERAMIC COLLECTION

The unique shapes of these bowls and platters add fun and intrigue to anything you serve in them.

Rectangular Ceramic Platters

- CER19** 14" L x 7 1/2" W x 2" H
(35.6 x 19.1 x 5.1 cm)
- CER23** 18 1/4" L x 9 1/4" W x 2 3/4" H
(46.4 x 23.5 x 7 cm)
- CER21** 21" L x 12 3/4" W x 3 1/4" H
(53.3 x 32.4 x 8.3 cm)

Square Ceramic Platter

- CER15** 14" Sq. x 1 1/2" H
(35.6 x 3.8 cm)

Wavy Ceramic Platters

- RTWVY1** 14 3/8" L x 8 3/4" W x 1 1/8" H
(36.5 x 22.2 x 2.9 cm)
- CER25** 21 3/4" L x 14 1/8" W x 2" H
(55.2 x 35.9 x 5.1 cm)

Squoval™ Ceramic Bowls

- SQVL712** 37 oz. (1.1 L)
12" L x 7" W x 2 3/4" H
(30.5 x 17.8 x 7 cm)
- SQVL914** 71 oz. (2.1 L)
14" L x 9" W x 3 1/4" H
(35.6 x 22.9 x 8.3 cm)



Shown with an AWRS riser set



Round Ceramic Bowls

- CER5** 40 oz. (1.2 L)
8 ½" Dia. x 3 ¼" H (21.6 x 8.3 cm)
- CER7** 60 oz. (1.8 L)
12" Dia. x 3 ¼" H (30.5 x 8.3 cm)
- CER9** 180 oz. (5.3 L)
17" Dia. x 5" H (43.2 x 12.7 cm)

Squound™ Ceramic Bowls and Sauce Cups

- SQSC15** 1 ½ oz. (44.4 mL)
2 ¾" Dia. x 1" H (7 x 2.5 cm)
- SQSC20** 2 oz. (59.1 mL)
3" Dia. x 1" H (7.6 x 2.5 cm)
- SQSC30** 3 oz. (88.7 mL)
3 ½" Dia. x 1 ¼" H (8.9 x 3.2 cm)
- SQSC40** 4 oz. (118.3 mL)
4" Dia. x 1 ½" H (10.2 x 3.8 cm)
- SQND7** 20 oz. (591.5 mL)
7" Dia. x 2 ⅞" H (17.8 x 7.3 cm)
- SQND9** 44 oz. (1.3 L)
9" Dia. x 3 ¼" H (22.9 x 8.3 cm)
- SQND11** 76 oz. (2.2 L)
10 ¾" Dia. x 4 ⅞" H (27.3 x 10.5 cm)
- SQND13** 122 oz. (3.6 L)
13" Dia. x 4 ½" H (33 x 11.4 cm)
- SQND15** 208 oz. (6.2 L)
15" Dia. x 5 ½" H (38.1 x 14 cm)





THE PRESTIGE™ PORCELAIN COLLECTION

The elegance of porcelain meets the playful profiles of our Prestige Collection, making this wide range of pieces extraordinarily versatile.

Square Porcelain Bowls and Sauce Cups

- CSC15** 1½ oz. (44.4 mL)
1" Sq. x 1⅛" H (2.5 x 2.9 cm)
- CSC20** 2 oz. (59.1 mL)
2½" Sq. x 1⅜" H (6.4 x 3.5 cm)
- WFB3** 3 oz. (88.7 mL)
3" Sq. x 1⅝" H (7.6 x 4.1 cm)
- SQB55** 13 oz. (384.5 mL)
4⅞" Sq. x 2¾" H (12.4 x 7 cm)
- WFB6** 24 oz. (709.8 mL)
6" Sq. x 2⅞" H (15.2 x 6.7 cm)
- SQB88** 48 oz. (1.4 L)
8¼" Sq. x 2½" H (21 x 6.4 cm)
- WFB9** 85 oz. (2.5 L)
9" Sq. x 4" H (22.9 x 10.2 cm)
- WFB12** 193 oz. (5.7 L)
12" Sq. x 5" H (30.5 x 12.7 cm)

Shallow Porcelain Bowls

- POR9** Square
72 oz. (2.1 L)
9¾" Sq. x 2¾" H
(24.8 x 7 cm)
- POR17** Rectangular
144 oz. (4.3 L)
17¾" L x 9¾" W x 2¾" H
(45.1 x 24.8 x 7 cm)



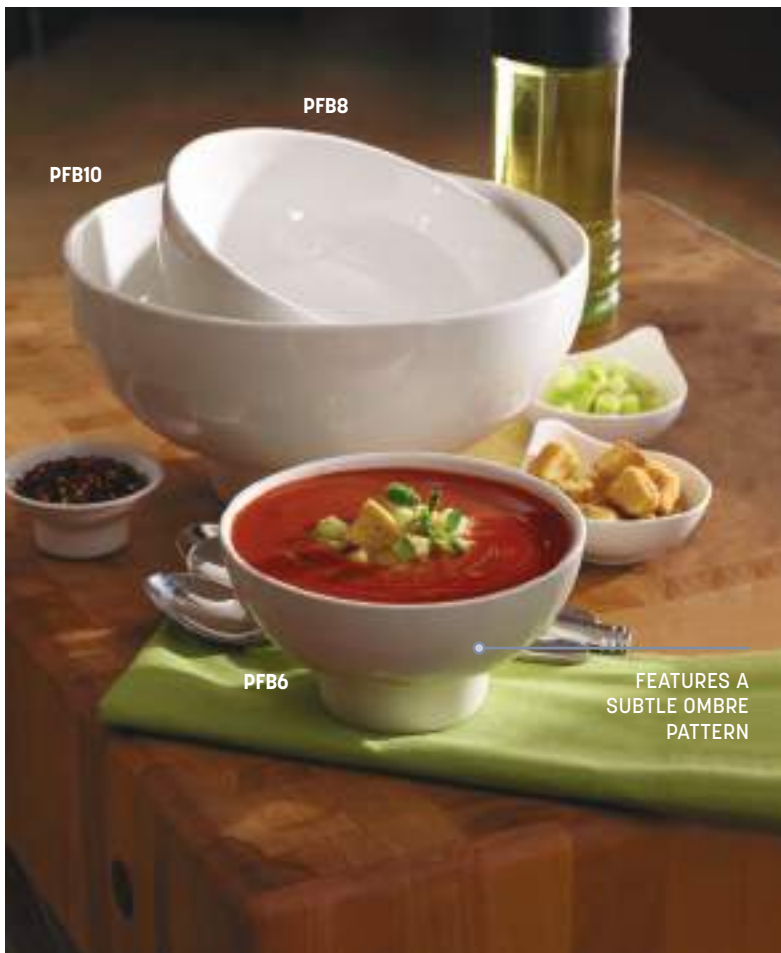

Squavy™ Porcelain Bowls and Sauce Cups

- SQVY1** 1½ oz. (44.4 mL)
2¼" Sq. x 1½" H (5.7 x 3.8 cm)
- SQVY2** 2½ oz. (73.9 mL)
2½" Sq. x 1⅝" H (6.4 x 4.1 cm)
- SQVY3** 5 oz. (147.9 mL)
3½" Sq. x 1⅞" H (8.9 x 4.8 cm)
- SQVY4** 15 oz. (443.6 mL)
4½" Sq. x 2½" H (11.4 x 6.4 cm)
- SQVY5** 25 oz. (739.3 mL)
5½" Sq. x 3" H (14 x 7.6 cm)
- SQVY8** 87 oz. (2.6 L)
8½" Sq. x 3¾" H (21.6 x 9.5 cm)
- SQVY10** 162 oz. (4.8 L)
10½" Sq. x 4⅜" H (26.7 x 11.1 cm)
- SQVY12** 228 oz. (6.7 L)
12" Sq. x 5" H (30.5 x 12.7 cm)

Footed Porcelain Bowls

- PFB6** 24 oz. (709.8 mL)
6" Dia. x 3⅛" H (15.2 x 7.9 cm)
- PFB8** 60 oz. (1.8 L)
8" Dia. x 4¼" H (20.3 x 10.8 cm)
- PFB10** 124 oz. (3.7 L)
10" Dia. x 5⅛" H (25.4 x 13 cm)



PORS140



FEATURES BUILT-IN SAUCE CUPS

PORS136

Porcelain Trays with Built-In Sauce Cups

PORS136 13" L x 6" W x 1/2" H
(33 x 15.2 x 1.3 cm)

PORS140 13" L x 9" W x 1/2" H
(33 x 22.9 x 1.3 cm)

Porcelain Impression Plate

CSP4 12 1/4" L x 11" W x 1" H
(31.1 x 27.9 x 2.5 cm)



CSP4

Rectangular Porcelain Platters

WLD11 11 1/2" L x 4" W x 7/8" H
(29.2 x 10.2 x 2.2 cm)

WLD13 13 1/2" L x 4 1/2" W x 1" H
(34.3 x 11.4 x 2.5 cm)

WLD15 15 1/2" L x 5" W x 1 1/8" H
(39.4 x 12.7 x 2.9 cm)



WLD15

WLD13

WLD11



STACKABLE FOR
EASY STORAGE PSPL8

PSPL12 shown with ACF125 card holder
and TAGA8WT mini chalk card



Shown with BLCHD1, BLCHBC1 card holders,
TAGA7WT mini chalk card and LFTD11 dome

PERFECT FOR BAKERIES, COFFEE
SHOPS AND DISPLAY CASES

Porcelain Serving Plates

Small bites, desserts, baked goods - pretty much everything looks good on these round porcelain serving plates. The crisp white color provides the perfect elegant backdrop for any culinary creation.

PSPL8 8" Dia. x 1 1/4" H
(20.3 x 3.2 cm)

PSPL12 12" Dia. x 1 1/4" H
(30.5 x 3.2 cm)

Porcelain Serving Stands

Give pastries and baked goods a lift with these porcelain pedestal stands. Available in a variety of sizes and heights, each can be used together or on its own to provide added height to any dessert.

PSP4 4" Dia. x 3" H
(10.2 x 7.6 cm)

PSP8 8" Dia. x 3 1/8" H
(20.3 x 7.9 cm)

PSP12 12" Dia. x 5 1/4" H
(30.5 x 13.3 cm)

Black Matte Finish Porcelain Casseroles

The look of cast iron meets the durability and weight of porcelain. Smaller casseroles (20-24 oz.) are perfect for shared sides or warm desserts. Larger casseroles (64-104 oz.) work well at buffets.

PBB9 20 oz. (591.5 mL)
7 1/4" L x 4 1/4" W x 2" H
9 1/4" L with Handles
(18.4 x 10.8 x 5.1, 23.5 cm)

PBB09 24 oz. (709.8 mL)
8 1/8" L x 6" W x 2 1/2" H
9 1/4" L with Handles
(20.6 x 15.2 x 6.4, 23.5 cm)

PBB8 24 oz. (709.8 mL)
6 1/2" Sq. x 2" H
8 1/4" L with Handles
(16.5 x 5.1, 21 cm)

PBB13 64 oz. (1.9 L)
11 5/8" L x 10" W x 2" H
13 1/2" L with Handles
(29.5 x 25.4 x 5.1, 34.3 cm)

PBB135 104 oz. (3.1 L)
10 1/2" L x 9 1/4" W x 3" H
13 1/8" L with Handles
(26.7 x 23.5 x 7.6, 33.3 cm)

PBB12 92 oz. (2.7 L)
12 1/4" L x 9 3/4" W x 2 1/2" H
(31.1 x 24.8 x 6.4 cm)





THE TRANSLUCENCE COLLECTION

We don't say "breathtaking" lightly, but this collection demands it. These handcrafted resin serving vessels feature a rich marbled design. Food-safe and stain-resistant, they combine elegance with durability.

Round Translucence Bowls and Platter

WSBM11 Bowl
84 ½ oz. (2.5 L)
11 ½" Dia. x 3 ½" H
(29.2 x 8.9 cm)

WSP15 Platter
74 ½ oz. (2.2 L)
15 ¼" Dia. x 2 ⅞" H
(38.7 x 5.4 cm)

WSBL15 Bowl
169 oz. (5 L)
15 ¾" Dia. x 3 ½" H
(40 x 8.9 cm)



Oblong Translucence Bowls

WSMB17 47 ½ oz. (1.4 L)
17 ¾" L x 4 ¾" W x 2 ⅝" H
(45.1 x 12.1 x 6 cm)

WSLB27 169 oz. (5 L)
27 ¼" L x 7 ½" W x 3 ⅜" H
(69.2 x 19.1 x 8.6 cm)

Rectangular Translucence Platter

WSRT21 21 ⅞" L x 9 ¾" W x 1 ⅞" H
(53.7 x 24.8 x 4.1 cm)





THE GLACIER™ GLASS COLLECTION

When it comes to our Glacier Collection, the beauty is in the details. These platters and bowls make every meal a social media-worthy moment.

Rectangular Green Glacier Platters

- BG159** 15" L x 9" W x 7/8" H
(38.1 x 22.9 x 2.2 cm)
- BG189** 18" L x 9" W x 7/8" H
(45.7 x 22.9 x 2.2 cm)
- BG1911** 19" L x 11" W x 7/8" H
(48.3 x 27.9 x 2.2 cm)
- BG2113** 21" L x 13" W x 7/8" H
(53.3 x 33 x 2.2 cm)

Round Glacier Bowls

Green Glass

- GBG14** 98 oz. (2.9 L)
14" Dia. x 3" H
(35.6 x 7.6 cm)
- GBG19** 128 oz. (3.8 L)
18" Dia. x 3 1/2" H
(45.7 x 8.9 cm)

Blue Glass

- GBB15** 98 oz. (2.9 L)
14" Dia. x 3" H
(35.6 x 7.6 cm)
- GBB20** 128 oz. (3.8 L)
18" Dia. x 3 1/2" H
(45.7 x 8.9 cm)





CRGSQ94

CRGSQ53

CRGSQ117

CRGSQ73

THE ORGANIC EDGES ON THESE RIMS ENHANCE THE NATURAL LOOK OF THESE PIECES



CRGT19

CRGT23

CRGT21

THE RAIN COLLECTION

From organic edges to natural rain-splashed designs, every detail of these plastic platters and bowls is crafted with intent. And because it's lightweight to boot, the Rain Collection is as practical as it is beautiful.

Square Rain Bowls

- CRGSQ53** 23 oz. (680.2 mL)
5" Sq. x 2 7/8" H (12.7 x 7.3 cm)
- CRGSQ73** 58 oz. (1.7 L)
7" Sq. x 3 1/4" H (17.8 x 8.3 cm)
- CRGSQ94** 125 oz. (3.7 L)
9 1/2" Sq. x 4" H (24.1 x 10.2 cm)
- CRGSQ117** 228 oz. (6.7 L)
12" Sq. x 4 1/2" H (30.5 x 11.4 cm)

Rectangular Rain Platters

- CRGT19** 48 oz. (1.4 L)
14" L x 7 1/2" W x 1 1/2" H
(35.6 x 19.1 x 3.8 cm)
- CRGT23** 92 oz. (2.7 L)
18 1/4" L x 9 1/4" W x 2" H
(46.4 x 23.5 x 5.1 cm)
- CRGT21** 152 oz. (4.5 L)
21" L x 13" W x 2" H
(53.3 x 33 x 5.1 cm)



THE ENDURANCE™ MELAMINE COLLECTION

If you need a collection that can stand the rigors of everyday performance, you're in the right place. These bowls, platters and plates are manufactured from highly durable melamine for long-lasting reliability. Not recommended for microwave use.

Shallow Melamine Bowls BPA FREE

- MELRC3** 10 oz. (295.7 mL)
5 5/8" L x 3 3/8" W x 1 3/4" H
(14.3 x 8.6 x 4.4 cm)
- MELSQ6** 16 oz. (473.2 mL)
6" Sq. x 2" H (15.2 x 5.1 cm)
- MELSQ8** 36 oz. (1.1 L)
8" Sq. x 2" H (20.3 x 5.1 cm)
- MELSQ10** 64 oz. (1.9 L)
10" Sq. x 2" H (25.4 x 5.1 cm)

Shallow Round Melamine Bowls BPA FREE

Whether you serve poke bowls, açai bowls or regular old mac & cheese, these beautiful white pieces will present your creations with style.

- MELR5** 8 oz. (236.6 mL)
5 1/4" Dia. x 1" H (13.3 x 2.5 cm)
- MELR6** 14 oz. (414 mL)
6 5/8" Dia. x 1 3/8" H (16.8 x 3.5 cm)
- MELR8** 28 oz. (828.1 mL)
8" Dia. x 1 3/4" H (20.3 x 4.4 cm)
- MELR9** 46 oz. (1.4 L)
9 1/2" Dia. x 2 1/8" H (24.1 x 5.4 cm)
- MELR11** 86 oz. (2.5 L)
11 1/4" Dia. x 2 3/8" H (28.6 x 6 cm)





Rectangular

Melamine Bowls

HOT **BPA FREE**

- MLRP9** 48 oz. (1.4 L)
9 3/4" L x 5 7/8" W x 2 3/4" H
(24.8 x 14.9 x 7 cm)
- MLRP13** 136 oz. (4 L)
13 3/4" L x 9 7/8" W x 2 3/4" H
(34.9 x 25.1 x 7 cm)
- MLRP17** 233 oz. (6.9 L)
17 5/8" L x 11 7/8" W x 2 3/4" H
(44.8 x 30.2 x 7 cm)
- MLRP19** 157 oz. (4.6 L)
19 5/8" L x 8" W x 3" H
(49.8 x 20.3 x 7.6 cm)

Square Melamine Bowls

HOT **BPA FREE**

- MELSQ53** 23 oz. (680.2 mL)
5" Sq. x 2 7/8" H
(12.7 x 7.3 cm)
- MELSQ73** 58 oz. (1.7 L)
7" Sq. x 3 1/4" H
(17.8 x 8.3 cm)
- MELSQ94** 125 oz. (3.7 L)
9 1/2" Sq. x 4" H
(24.1 x 10.2 cm)
- MELSQ117** 208 oz. (6.2 L)
12" Sq. x 4 1/2" H
(30.5 x 11.4 cm)

Oblong Melamine Bowls BPA FREE

These memorable oval-shaped bowls are perfectly sized for a variety of food presentations. Ideal for buffets and table service alike.

- MLRS9** 18 oz. (532.3 mL)
9" L x 6" W x 1 3/4" H
(22.9 x 15.2 x 4.4 cm)
- MLRS12** 42 oz. (1.2 L)
12" L x 9" W x 2" H
(30.5 x 22.9 x 5.1 cm)
- MLRS16** 64 oz. (1.9 L)
16 7/8" L x 8 1/4" W x 2 3/8" H
(42.9 x 21 x 6 cm)
- MLRS21** 194 oz. (5.7 L)
21" L x 14" W x 2 7/8" H
(53.3 x 35.6 x 7.3 cm)

Angled Round Melamine Bowls BPA FREE

- MELSL52** 11 oz. (325.3 mL)
5" Dia. x 3 1/4" H
(12.7 x 8.3 cm)
- MELSL82** 40 oz. (1.2 L)
8" Dia. x 5" H
(20.3 x 12.7 cm)
- MELSL92** 64 oz. (1.9 L)
9 1/4" Dia. x 5 1/4" H
(23.5 x 13.3 cm)
- MELSL112** 112 oz. (3.3 L)
12" Dia. x 6 1/2" H
(30.5 x 16.5 cm)





FLRB95

FLRB8

FLRB11

Flared Round Melamine Bowls BPA FREE

- FLRB8 33 oz. (1 L)
8" Dia. x 3 3/4" H (20.3 x 9.5 cm)
- FLRB95 54 oz. (1.6 L)
9 1/2" Dia. x 4" H (24.1 x 10.2 cm)
- FLRB11 80 oz. (2.4 L)
11" Dia. x 4 3/4" H (27.9 x 12.1 cm)

Round Melamine Bowls BPA FREE

- MEL5 57 oz. (1.7 L)
8 1/2" Dia. x 3 3/8" H (21.6 x 8.6 cm)
- MEL7 87 oz. (2.6 L)
12" Dia. x 3 3/4" H (30.5 x 9.5 cm)
- MEL9 270 oz. (8 L)
17" Dia. x 4 7/8" H (43.2 x 12.4 cm)

MEGA Melamine Bowl BPA FREE

- MEL22 25 qt. (23.7 L)
24" Dia. x 6" H (61 x 15.2 cm)



MEL9

FITS THE TTRS3
STAND PG. 282



MEL7



MEL5



MEL22



Crave Melamine Serveware NSF BPA FREE

Round Bowls

- CBL78CL** Cloud, 78 oz. (2.3 L)
9 1/2" Dia. x 3 5/8" H (24.1 x 9.2 cm)
- CBL78SH** Shadow, 78 oz. (2.3 L)
9 1/2" Dia. x 3 5/8" H (24.1 x 9.2 cm)
- CBL185CL** Cloud, 185 oz. (5.5 L)
13" Dia. x 4 1/2" H (33 x 11.4 cm)
- CBL185SH** Shadow, 185 oz. (5.5 L)
13" Dia. x 4 1/2" H (33 x 11.4 cm)
- CBL325CL** Cloud, 10.2 qt. (9.6 L)
16" Dia. x 5 1/4" H (40.6 x 13.3 cm)
- CBL325SH** Shadow, 10.2 qt. (9.6 L)
16" Dia. x 5 1/4" H (40.6 x 13.3 cm)
- CBL54ST** Storm, 54 oz. (1.6 L)
7 5/8" Dia. x 4 1/8" H (19.4 x 10.5 cm)
- CBL96SH** Shadow, 96 oz. (2.8 L)
9 1/4" Dia. x 4 7/8" H (23.5 x 12.4 cm)
- CBL141CL** Cloud, 141 oz. (4.2 L)
10 1/2" Dia. x 5 1/2" H (26.7 x 14 cm)



Rectangular Platters

- CPL14CL** Cloud
14 1/4" L x 7 3/8" W x 1 3/8" H
(36.2 x 18.7 x 3.5 cm)
- CPL14SH** Shadow
14 1/4" L x 7 3/8" W x 1 3/8" H
(36.2 x 18.7 x 3.5 cm)
- CPL21CL** Cloud
21" L x 12 7/8" W x 2" H
(53.3 x 32.7 x 5.1 cm)
- CPL21SH** Shadow
21" L x 12 7/8" W x 2" H
(53.3 x 32.7 x 5.1 cm)





Melamine Serving Plates BPA FREE

Serve up your favorite pie on these versatile, durable and washable melamine serving plates. A sleek way to plate up any slice!

- MTP10** 10" Dia. x ¾" H (25.4 x 1.9 cm)
- MTP12** 12" Dia. x 1 ⅛" H (30.5 x 2.9 cm)
- MTP14** 14" Dia. x 1 ⅛" H (35.6 x 2.9 cm)
- MTP16** 16" Dia. x 1 ⅛" H (40.6 x 2.9 cm)
- MTP18** 18" Dia. x 1 ⅜" H (45.7 x 3.5 cm)

Square Melamine Platters BPA FREE

- SQP10** 12" Sq. x 1 ⅜" H (30.5 x 3.5 cm)
- SQP12** 14" Sq. x 1 ½" H (35.6 x 3.8 cm)
- SQP16** 16" Sq. x 2" H (40.6 x 5.1 cm)

Flat Melamine Platters BPA FREE

- MEL148** 14 ½" L x 8 ¼" W x ¾" H (36.8 x 21 x 1.9 cm)
- MEL189** 18 ¼" L x 9" W x ¾" H (46.4 x 22.9 x 1.9 cm)
- MEL1414** 14 ¾" Sq. x ¾" H (36.5 x 1.9 cm)
- MEL2113** 21 ½" L x 13" W x ¾" H (54.6 x 33 x 1.9 cm)





Rectangular Melamine Platters



- MEL12** 12" L x 7" W x 1 1/4" H
(30.5 x 17.8 x 3.2 cm)
- MEL19** 14 1/8" L x 7 1/2" W x 1 1/2" H
(35.9 x 19.1 x 3.8 cm)
- MEL23** 18 1/4" L x 9" W x 1 1/8" H
(46.4 x 22.9 x 4.8 cm)
- MEL21** 21 5/8" L x 13" W x 1 7/8" H
(54.9 x 33 x 4.8 cm)

Disposable Liners

- PBSL1** PET Liner for MEL19
13 3/4" L x 7 1/4" W x 1" H
(34.9 x 18.4 x 2.5 cm)
- PBSL2** PET Liner for MEL23
17 1/2" L x 8 3/4" W x 2" H
(44.5 x 22.2 x 5.1 cm)
- PBSL3** PET Liner for MEL21
19 1/2" L x 12" W x 2" H
(49.5 x 30.5 x 5.1 cm)

Concave Melamine Platters



- MEL44** Triangular
17" L x 2 1/4" H
(43.2 x 5.7 cm)
- MEL42** Square
12" Sq. x 1 5/8" H
(30.5 x 4.1 cm)
- MEL43** Square
16" Sq. x 2" H
(40.6 x 5.1 cm)

Boat Melamine Platters



- MEL49** 24" L x 9" W x 1 5/8" H
(61 x 22.9 x 4.1 cm)
- MEL50** 28" L x 11 1/4" W x 1 1/2" H
(71.1 x 28.6 x 3.8 cm)



FROM TOP
TO BOTTOM:
AWMEL19
AWMEL23
AWMEL21



DETAILED WITH ORGANIC EDGES,
TEXTURED SURFACES AND MOTTLED ACCENTS



PORCELAIN LOOKS, MELAMINE DURABILITY

Rectangular Antique White Melamine Platters BPA FREE

- AWMEL19** 14 1/4" L x 7 1/2" W x 1 1/2" H
(36.2 x 19.1 x 3.8 cm)
- AWMEL23** 18" L x 8 1/4" W x 2" H
(45.7 x 21 x 5.1 cm)
- AWMEL21** 21" L x 13" W x 2" H
(53.3 x 33 x 5.1 cm)

Square Antique White Melamine Bowls BPA FREE

- AWMSQ53** 23 oz. (680.2 mL)
5" Sq. x 2 7/8" H
(12.7 x 7.3 cm)
- AWMSQ73** 58 oz. (1.7 L)
7" Sq. x 3 1/4" H
(17.8 x 8.3 cm)
- AWMSQ94** 125 oz. (3.7 L)
9 1/2" Sq. x 4" H
(24.1 x 10.2 cm)
- AWMSQ117** 216 oz. (6.4 L)
12" Sq. x 4 1/2" H
(30.5 x 11.4 cm)



Trapezoid Melamine Platters BPA FREE

- TRPZ12** 12 1/2" L x 8 1/4" W x 1 1/2" H
(31.8 x 21 x 3.8 cm)
- TRPZ18** 18 3/8" L x 8 1/8" W x 1 1/2" H
(46.7 x 20.6 x 3.8 cm)
- TRPZ23** 22 7/8" L x 8 1/4" W x 1 1/2" H
(58.1 x 21 x 3.8 cm)

Rectangular Melamine Serving Trays BPA FREE

Simple and versatile, these white melamine trays are as dapper as they are durable.

- TMW9** 9 3/8" L x 5 1/8" W x 3/4" H
(23.8 x 13 x 1.9 cm)
- TMW13** 13 7/8" L x 6 1/2" W x 7/8" H
(35.2 x 16.5 x 2.2 cm)
- TMW16** 16" L x 8" W x 1 1/8" H
(40.6 x 20.3 x 2.9 cm)

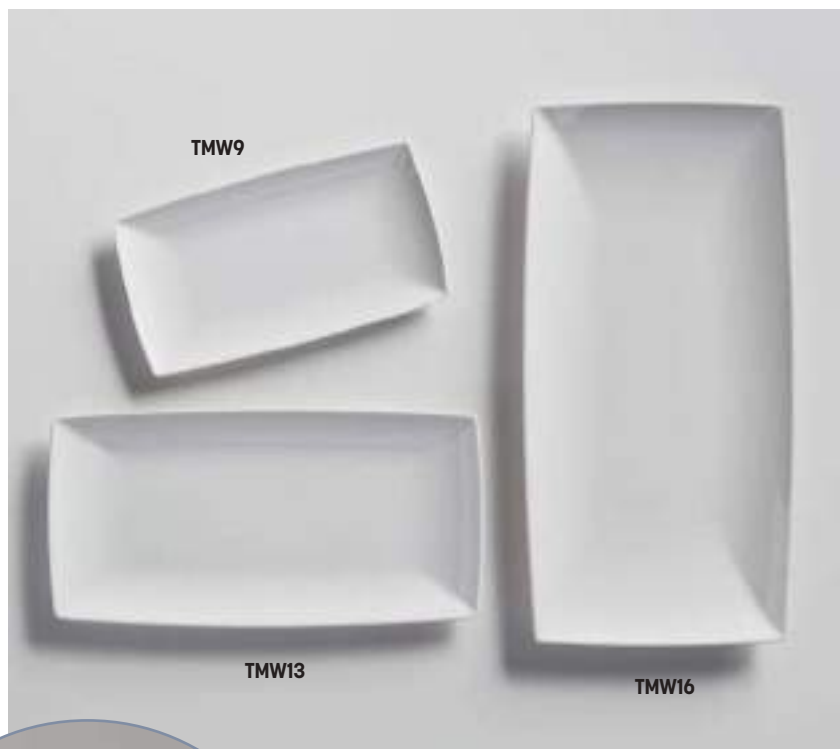

WORKS PERFECTLY IN HIGH-END SETTINGS



Black Rimmed Rectangular Melamine Bowls BPA FREE

- MRCW6** 26 oz. (768.9 mL)
6 7/8" L x 4 1/8" W x 3 1/4" H (17.5 x 10.5 x 8.3 cm)
- MRCW7** 44 oz. (1.3 L)
6 3/8" L x 6 7/8" W x 3 1/4" H (16.2 x 17.5 x 8.3 cm)
- MRCW10** 64 oz. (1.9 L)
10 3/8" L x 6 3/8" W x 3 1/4" H (26.4 x 16.2 x 8.3 cm)
- MRCW13** 82 oz. (2.4 L)
12 5/8" L x 6 3/4" W x 3 1/4" H (32.1 x 17.1 x 8.3 cm)
- MRCW9** 98 oz. (2.9 L)
9 3/4" Sq. x 3 1/4" H (24.8 x 8.3 cm)
- MRW615** 106 oz. (3.1 L)
15" L x 6" W x 3 1/4" H (38.1 x 15.2 x 8.3 cm)
- MRCW12** 131 oz. (3.9 L)
11 3/4" L x 10 3/8" W x 3 1/4" H (29.8 x 26.4 x 8.3 cm)
- MRW815** 144 oz. (4.3 L)
15" L x 8" W x 3 1/4" H (38.1 x 20.3 x 8.3 cm)
- MRW1215** 212 oz. (6.3 L)
15" L x 12" W x 3 1/4" H (38.1 x 30.5 x 8.3 cm)

Black Rimmed Rectangular Melamine Platters HOT BPA FREE

- MRSW6** 6 7/8" L x 4 1/4" W x 1 1/8" H
(17.5 x 10.8 x 2.9 cm)
- MRSW13** 12 3/4" L x 7" W x 1 1/8" H
(32.4 x 17.8 x 2.9 cm)
- MRSW9** 9 7/8" Sq. x 1 1/8" H
(25.1 x 2.9 cm)
- MRSW12** 12 7/8" L x 10 1/4" W x 1 1/8" H
(32.7 x 26 x 2.9 cm)

Shown with PSP8 and PSP4 serving stands and GVHT1 tongs

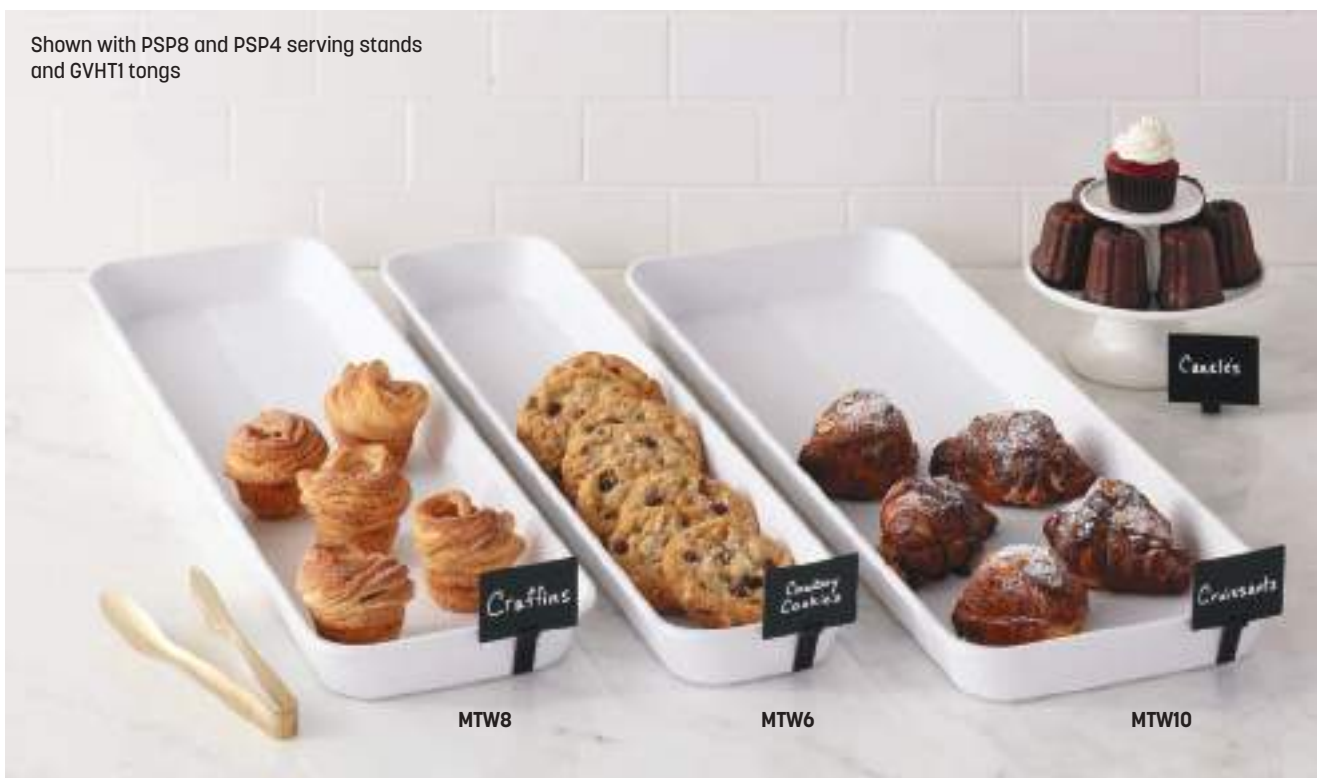

Rectangular Market Trays BPA FREE

The perfect solution for deli cases everywhere, these large melamine trays beautifully display all types of food.

White

- MTW6** 150 oz. (4.4 L)
29 3/4" L x 6 1/8" W x 2" H
(75.6 x 15.6 x 5.1 cm)
- MTW8** 216 oz. (6.4 L)
29 3/4" L x 8 1/2" W x 2" H
(75.6 x 21.6 x 5.1 cm)
- MTW10** 270 oz. (8 L)
29 3/4" L x 10 1/2" W x 2" H
(75.6 x 26.7 x 5.1 cm)

Black

- MT6** 150 oz. (4.4 L)
29 3/4" L x 6 1/8" W x 2" H
(75.6 x 15.6 x 5.1 cm)
- MT8** 216 oz. (6.4 L)
29 3/4" L x 8 1/2" W x 2" H
(75.6 x 21.6 x 5.1 cm)
- MT10** 270 oz. (8 L)
29 3/4" L x 10 1/2" W x 2" H
(75.6 x 26.7 x 5.1 cm)





RCR21 cover shown on MREC21 platter

RCRD14 cover shown on MRDB14 bowl

RCR13 cover shown on MREC13 platter



RCRD14 cover shown on MRDB14 bowl

MTP14

Shown with MCB10MA cup, MCP6MA plate, HM8TNG tongs, HCHS1 card holder and TAGA8WT chalk card

Covered Solutions

More freshness, less germs at your buffet station when you use one of our Covered Solutions. Each melamine platter or bowl pairs perfectly with a roll-top cover made of crystal clear polycarbonate. Pick your sizes and capacities to build the perfect display.

Roll-Top Covers

- RCR13** Rectangular, Half-Size
13 1/4" L x 10 1/2" W x 6 1/4" H
(33.7 x 26.7 x 15.9 cm)
- RCR21** Rectangular, Full-Size
21" L x 13 1/8" W x 7 1/4" H
(53.3 x 33.3 x 18.4 cm)
- RCRD14** Round
14 1/2" Dia. x 7 1/2" H
(36.8 x 19.1 cm)

Platters

- MREC13** Rectangular, Half-Size
12 3/4" L x 10 3/8" W x 1 1/4" H
(32.4 x 26.4 x 3.2 cm)
- MREC21** Rectangular, Full-Size
20 7/8" L x 12 3/4" W x 1 1/4" H
(53 x 32.4 x 3.2 cm)
- MTP14** Round
14" Dia. x 1 1/8" H
(35.6 x 2.9 cm)

Bowls

- MRECB13** Rectangular, Half-Size
176 oz. (5.2 L)
12 3/4" L x 10 3/8" W x 4" H
(32.4 x 26.4 x 10.2 cm)
- MRECB21** Rectangular, Full-Size
328 oz. (9.7 L)
20 7/8" L x 12 3/4" W x 4" H
(53 x 32.4 x 10.2 cm)
- MRDB14** Round, 278 oz. (8.2 L)
14" Dia. x 5 1/4" H
(35.6 x 13.3 cm)



WARNING: This product can expose you to chemicals including Bisphenol A (BPA), which is known to the State of California to cause birth defects or other reproductive harm. For more information, go to www.P65warnings.ca.gov. Warning applies to State of California only.



RCR21 cover shown on MREC21 bowl

MREC21

Shown with WBP34 and WBC36 bottles, BLR14 drinkware, MCP6MA plates, HM8TNG tongs, HCHS1 card holder and TAGA8WT chalk card



RCR13 cover shown on MREC13 platter

MREC13

Shown with GSC6 shaker, GC8 carafe, MMP8 serving dish, HCHS1 card holder and TAGA8WT chalk card



LFTBW9 shown with LFTB65 pedestal

LFTBW8

LFTBW11

THE LIFT COLLECTION

Take your presentation to new heights with our Lift Collection. This family of bowls, plates, pedestals and domes is designed to quite literally elevate your culinary creations. They give your dishes a beautiful platform and draw your guests' attention to where it should be: the food. Buildable, durable and interchangeable, you might just find the Lift Collection indispensable.

Lift Collection Bowls BPA FREE

White

- LFTBW8** 40 oz. (1.2 L)
8 1/2" Dia. x 3 1/2" H (21.6 x 8.9 cm)
- LFTBW9** 68 oz. (2 L)
9 7/8" Dia. x 4 1/2" H (25.1 x 11.4 cm)
- LFTBW11** 110 oz. (3.3 L)
11 1/4" Dia. x 5 1/2" H (28.6 x 14 cm)

Black-Speckled

- LFTBB8** 40 oz. (1.2 L)
8 1/2" Dia. x 3 1/2" H (21.6 x 8.9 cm)
- LFTBB9** 68 oz. (2 L)
9 7/8" Dia. x 4 1/2" H (25.1 x 11.4 cm)
- LFTBB11** 110 oz. (3.3 L)
11 1/4" Dia. x 5 1/2" H (28.6 x 14 cm)



LFTBB9 shown with LFTB65 pedestal

LFTBB8

LFTBB11



FEATURES A TRENDY, SPECKLED DESIGN

Lift Collection Plates BPA FREE

White

- LFTPW11** 8 7/8" Dia. x 1" H (22.5 x 2.5 cm)
- LFTPW12** 11 3/4" Dia. x 1" H (29.8 x 2.5 cm)
- LFTPW13** 13" Dia. x 1" H (33 x 2.5 cm)

Black-Speckled

- LFTPB11** 8 7/8" Dia. x 1" H (22.5 x 2.5 cm)
- LFTPB12** 11 3/4" Dia. x 1" H (29.8 x 2.5 cm)
- LFTPB13** 13" Dia. x 1" H (33 x 2.5 cm)

Lift Collection Pedestals BPA FREE

White

- LFTW63** 6 1/2" Dia. x 3 1/4" H (16.5 x 8.3 cm)
- LFTW65** 6 1/2" Dia. x 4 7/8" H (16.5 x 12.4 cm)
- LFTW67** 6 1/2" Dia. x 7 1/8" H (16.5 x 18.1 cm)

Black

- LFTB63** 6 1/2" Dia. x 3 1/4" H (16.5 x 8.3 cm)
- LFTB65** 6 1/2" Dia. x 4 7/8" H (16.5 x 12.4 cm)
- LFTB67** 6 1/2" Dia. x 7 1/8" H (16.5 x 18.1 cm)

Lift Collection Domes ⚠

- LFTD8** 8 1/8" Dia. x 6 5/8" H (20.6 x 16.8 cm)
- LFTD11** 11" Dia. x 8 5/8" H (27.9 x 21.9 cm)
- LFTD12** 12 1/8" Dia. x 9 1/8" H (30.8 x 23.2 cm)



⚠ **WARNING:** This product can expose you to chemicals including Bisphenol A (BPA), which is known to the State of California to cause birth defects or other reproductive harm. For more information, go to www.P65warnings.ca.gov. Warning applies to State of California only.

Shown with BCH125 card holders

LFTBW12 shown with
LFTB67 pedestal



LFTBW16



LFTBB12 shown with
LFTW67 pedestal

LFTBB16

Lift Collection Serving Bowls BPA FREE

Larger functions require larger capacities. Available in both 94 and 104 ounces, these generously-sized angled bowls are ideal for feeding the crowd. Give each bowl a "lift" with one of the collection's threaded pedestals (sold separately) and you are ready for the masses.

White

LFTBW12 94 oz. (2.8 L)
12" Dia. x 4" H (30.5 x 10.2 cm)

LFTBW16 104 oz. (3.1 L)
16" Dia. x 3" H (40.6 x 7.6 cm)

Black-Speckled

LFTBB12 94 oz. (2.8 L)
12" Dia. x 4" H (30.5 x 10.2 cm)

LFTBB16 104 oz. (3.1 L)
16" Dia. x 3" H (40.6 x 7.6 cm)

Lift Collection Platters BPA FREE

Our Lift Collection plates now have big brothers. Amply sized to feed large groups, each platter offers the flexibility to be used with or without a pedestal (sold separately). Mix with the other plates and bowls in the line for a truly flexible and versatile presentation.

Black-Speckled

LFTPBB22 22" L x 12" W x 2 1/4" H
(55.9 x 30.5 x 5.7 cm)

LFTPBB24 24" L x 9 1/2" W x 2 3/4" H
(61 x 24.1 x 7 cm)

White

LFTPWB22 22" L x 12" W x 2 1/4" H
(55.9 x 30.5 x 5.7 cm)

LFTPWB24 24" L x 9 1/2" W x 2 3/4" H
(61 x 24.1 x 7 cm)

Lift Collection

Tiered Stands NEW BPA FREE

Display your baked goods, light bites and more on this melamine tiered stand! Plates are available in multiple sizes so you can create a dynamic presentation. The melamine construction makes this stand highly durable - ideal for a catered event or busy establishment.

Black-Speckled

LFTTSB17 7 7/8" Dia. Small Plate (20 cm)
9 7/8" Dia. Medium Plate (25.1 cm)
12 5/8" Dia. Large Plate (32.1 cm)
17 1/2" H (44.5 cm) Fully Assembled

White

LFTTSW17 7 7/8" Dia. Small Plate (20 cm)
9 7/8" Dia. Medium Plate (25.1 cm)
12 5/8" Dia. Large Plate (32.1 cm)
17 1/2" H (44.5 cm) Fully Assembled

Replacement Rods

LFTTSRRS Stainless Steel

LFTTSRRB Black

CUSTOMIZE FOR A ONE-TIER, TWO-TIER OR THREE-TIER PRESENTATION. FEATURES PLATES WITH A REVERSIBLE DESIGN



Shown with BAMBL125, BAMBL4 card holders, TAGA7WT chalk cards, GGRW3 bowls and SLR3 lids

LFTPBB24 shown with LFTW65 pedestal



LFTPBB22

LFTPWB24 shown with LFTW63 pedestal



LFTPWB24



LFTTSB17

LFTTSW17

NEW



THE GRAB & GO COLLECTION

Pack it, stack it and grab it! This reusable collection was curated with reinvention of buffet and group dining in mind. Made of dishwasher-safe melamine and coordinating SAN lids, these bowls keep food safe from germs and contaminants.

Round Bowls BPA FREE

White

- GGRW3** 4 oz. (118.3 mL)
3 ¾" Dia. x 1 ¾" H (8.6 x 3.5 cm)
- GGRW5** 9 ½ oz. (280.9 mL)
4 ⅞" Dia. x 1 ⅞" H (12.4 x 4.8 cm)
- GGRW6** 18 oz. (532.3 mL)
6" Dia. x 2 ¾" H (15.2 x 6 cm)
- GGRW8** 32 oz. (946.4 mL)
8 ½" Dia. x 2" H (21.6 x 5.1 cm)

Black-Speckled

- GGRB3** 4 oz. (118.3 mL)
3 ¾" Dia. x 1 ¾" H (8.6 x 3.5 cm)
- GGRB5** 9 ½ oz. (280.9 mL)
4 ⅞" Dia. x 1 ⅞" H (12.4 x 4.8 cm)
- GGRB6** 18 oz. (532.3 mL)
6" Dia. x 2 ¾" H (15.2 x 6 cm)
- GGRB8** 32 oz. (946.4 mL)
8 ½" Dia. x 2" H (21.6 x 5.1 cm)

Round Bowl Lids

- SLR3** Fits GGRW3 and GGRB3
3 ½" Dia. x 1" H (8.9 x 2.5 cm)
- SLR5** Fits GGRW5 and GGRB5
5 ½" Dia. x 1" H (13 x 2.5 cm)
- SLR6** Fits GGRW6 and GGRB6
6 ⅞" Dia. x 1" H (15.6 x 2.5 cm)
- SLR8** Fits GGRW8 and GGRB8
8 ½" Dia. x 1" H (21.6 x 2.5 cm)
(not shown)



Square Bowls

White

GGSW5 12 ½ oz. (369.7 mL)
5" Sq. x 1 ⅝" H (12.7 x 4.1 cm)

GGSW6 27 oz. (798.5 mL)
6 ½" Sq. x 2 ⅝" H (16.5 x 5.4 cm)

Black-Speckled

GGSB5 12 ½ oz. (369.7 mL)
5" Sq. x 1 ⅝" H (12.7 x 4.1 cm)

GGSB6 27 oz. (798.5 mL)
6 ½" Sq. x 2 ⅝" H (16.5 x 5.4 cm)

Square Bowl Lids

SLS5 Fits GGSW5 and GGSB5
5" Sq. x 1" H (12.7 x 2.5 cm)

SLS6 Fits GGSW6 and GGSB6
6 ⅝" Sq. x 1" H (16.8 x 2.5 cm)



Rectangular Bowls

White

GGW74 17 oz. (502.8 mL)
7" L x 4 ¼" W x 2 ⅝" H
(17.8 x 10.8 x 5.4 cm)

GGW76 46 oz. (1.4 L)
7" L x 6 ⅜" W x 3" H
(17.8 x 16.2 x 7.6 cm)

GGW96 25 ½ oz. (754.1 mL)
9" L x 6" W x 2" H
(22.9 x 15.2 x 5.1 cm)

Black-Speckled

GGB74 17 oz. (502.8 mL)
7" L x 4 ¼" W x 2 ⅝" H
(17.8 x 10.8 x 5.4 cm)

GGB76 46 oz. (1.4 L)
7" L x 6 ⅜" W x 3" H
(17.8 x 16.2 x 7.6 cm)

GGB96 25 ½ oz. (754.1 mL)
9" L x 6" W x 2" H
(22.9 x 15.2 x 5.1 cm)

Rectangular Bowl Lids

SL74 Fits GGW74 and GGB74
7 ⅞" L x 4 ⅜" W x 1" H
(18.1 x 11.1 x 2.5 cm)

SL76 Fits GGW76 and GGB76
7" L x 6 ½" W x 1" H
(17.8 x 16.5 x 2.5 cm)

SL96 Lid, Fits GGW96 and GGB96
9" L x 6" W x 1" H
(22.9 x 15.2 x 2.5 cm)
(not shown)





Oval Melamine Platters BPA FREE

High-style oval serving shapes add depth and beauty to the buffet, offered in your choice of dual-tone matte black or matte white with a glossy white center. Made of sleek yet durable melamine, these oval platters offer ample room for serving anything from appetizers, salads to entrees.

Black/White

- NP14** 14" L x 9" W x 1 3/8" H
(35.6 x 22.9 x 3.5 cm)
- NP18** 18" L x 12" W x 1 3/4" H
(45.7 x 30.5 x 4.4 cm)
- NP21** 21 1/2" L x 14 3/8" W x 2" H
(54.6 x 36.5 x 5.1 cm)

White NEW

- NPW14** 14" L x 9" W x 1 3/8" H
(35.6 x 22.9 x 3.5 cm)
- NPW18** 18" L x 12" W x 1 3/4" H
(45.7 x 30.5 x 4.4 cm)
- NPW21** 21 1/2" L x 14 3/8" W x 2" H
(54.6 x 36.5 x 5.1 cm)

Round Melamine Noodle Bowls BPA FREE

Serve up today's global fare in our traditional yet contemporary noodle bowls. Featuring a sleek finish of matte black or matte white with a glossy white center and the most popular capacities, these bowls create a beautiful backdrop for your noodle creations. Also available in larger serving options.

Black/White

- NB30** 30 oz. (887.2 mL)
6 ¾" Dia. x 3 ½" H (17.1 x 8.9 cm)
- NB32** 32 oz. (946.4 mL)
8" Dia. x 3" H (20.3 x 7.6 cm)
- NB50** 50 oz. (1.5 L)
7 ½" Dia. x 3 ⅞" H (19.1 x 9.8 cm)
- NB56** 56 oz. (1.7 L)
10" Dia. x 3 ⅜" H (25.4 x 8.6 cm)
- NB85** 85 oz. (2.5 L)
9" Dia. x 4 ½" H (22.9 x 11.4 cm)
- NB120** 120 oz. (3.5 L)
10" Dia. x 5 ⅞" H (25.4 x 13 cm)

White NEW

- NBW30** 30 oz. (887.2 mL)
6 ¾" Dia. x 3 ½" H (17.1 x 8.9 cm)
- NBW32** 32 oz. (946.4 mL)
8" Dia. x 3" H (20.3 x 7.6 cm)
- NBW50** 50 oz. (1.5 L)
7 ½" Dia. x 3 ⅞" H (19.1 x 9.8 cm)
- NBW56** 56 oz. (1.7 L)
10" Dia. x 3 ⅜" H (25.4 x 8.6 cm)
- NBW85** 85 oz. (2.5 L)
9" Dia. x 4 ½" H (22.9 x 11.4 cm)
- NBW120** 120 oz. (3.5 L)
10" Dia. x 5 ⅞" H (25.4 x 13 cm)





THE FAUX SLATE COLLECTION

It's easy to mistake our Faux Slate Collection for the real thing, but take another look and you'll discover that these gorgeous pieces are actually crafted from durable, washable melamine. Accessorize your tabletops with these unique bowls, platters and peels.

White Square Faux Slate Melamine Bowls BPA FREE

- FSWMEL53** 23 oz. (680.2 mL)
5" Sq. x 2 7/8" H (12.7 x 7.3 cm)
- FSWMEL73** 58 oz. (1.7 L)
7" Sq. x 3 1/4" H (17.8 x 8.3 cm)
- FSWMEL94** 125 oz. (3.7 L)
9 1/2" Sq. x 4" H (24.1 x 10.2 cm)
- FSWMEL117** 208 oz. (6.2 L)
12" Sq. x 4 1/2" H (30.5 x 11.4 cm)

White Faux Slate Flat Melamine Platters BPA FREE

- FSLW10** 10" L x 8 1/4" W x 1/4" H
(25.4 x 21 x 0.6 cm)
- FSLW08** 14 3/4" L x 8 1/4" W x 1/4" H
(37.5 x 21 x 0.6 cm)
- FSLW18** 18" L x 8 1/2" W x 1/4" H
(45.7 x 21.6 x 0.6 cm)
- FSLW14** 14 1/2" Sq. x 1/4" H
(36.8 x 0.6 cm)
- FSLW21** 21 1/2" L x 13" W x 1/4" H
(54.6 x 33 x 0.6 cm)

FSMEL117



FSMEL94



FSMEL53



FSMEL73



Black Square Faux Slate Melamine Bowls

- FSMEL53 23 oz. (680.2 mL)
5" Sq. x 2 7/8" H (12.7 x 7.3 cm)
- FSMEL73 58 oz. (1.7 L)
7" Sq. x 3 1/4" H (17.8 x 8.3 cm)
- FSMEL94 125 oz. (3.7 L)
9 1/2" Sq. x 4" H (24.1 x 10.2 cm)
- FSMEL117 208 oz. (6.2 L)
12" Sq. x 4 1/2" H (30.5 x 11.4 cm)

Black Faux Slate Flat Melamine Platters

- FSLT10 10" L x 8 1/4" W x 1/4" H
(25.4 x 21 x 0.6 cm)
- FSLT08 14 3/4" L x 8 1/4" W x 1/4" H
(37.5 x 21 x 0.6 cm)
- FSLT18 18" L x 8 1/2" W x 1/4" H
(45.7 x 21.6 x 0.6 cm)
- FSLT14 14 1/2" Sq. x 1/4" H
(36.8 x 0.6 cm)
- FSLT21 21 1/2" L x 13" W x 1/4" H
(54.6 x 33 x 0.6 cm)



HOT

FSLT08 shown with MICH25, MICH10 milk cans

USE WITH SECURIT MARKERS-EASY TO IDENTIFY, SIMPLE TO WIPE CLEAN. SEE PG. 321



Black Faux Slate Melamine Platters BPA FREE

The chic texture of slate meets the durability of melamine with these stunning black trays, now with rims to help hold and showcase your latest menu creations.

- FSMEL12** 12" L x 7" W x 1½" H
(30.5 x 17.8 x 3.8 cm)
- FSMEL19** 14" L x 7½" W x 1½" H
(35.6 x 19.1 x 3.8 cm)
- FSMEL23** 18" L x 8¼" W x 2" H
(45.7 x 21 x 5.1 cm)
- FSMEL21** 21" L x 13" W x 2" H
(53.3 x 33 x 5.1 cm)

Black Faux Slate Melamine Serving Peels BPA FREE

- FSR9** 9" Dia. x ⅝" H
12 ⅝" L with Handle
(22.9 x 1.6, 32.1 cm)
- FSR11** 12" Dia. x ⅝" H
16 ¾" L with Handle
(30.5 x 1.6, 42.5 cm)
- FSR14** 15" Dia. x ⅝" H
20 ¾" L with Handle
(38.1 x 1.6, 52.7 cm)



Shown with SVHT6 tongs

THE MELAMINE NATURALS COLLECTION

At first glance, these boards look like real stone and wood serving pieces. But upon closer examination, they're actually crafted from durable, dishwasher-safe melamine.

White Marble Melamine Platters and Bowls BPA FREE

With an elegant marble finish, these bowls and platters are truly chic. They come in the same sizes as our traditional melamine bowls and platters with a modern shape.

- MWME12** 12" L x 7" W x 1 1/2" H
(30.5 x 17.8 x 3.8 cm)
- MWME19** 14" L x 7 1/2" W x 1 1/2" H
(35.6 x 19.1 x 3.8 cm)
- MWME23** 18" L x 8 1/4" W x 2" H
(45.7 x 21 x 5.1 cm)
- MWME21** 21" L x 13" W x 2" H
(53.3 x 33 x 5.1 cm)
- MWMSQ5** 19 oz. (561.9 mL)
5" Sq. x 2 7/8" H (12.7 x 7.3 cm)
- MWMSQ7** 54 oz. (1.6 L)
7" Sq. x 3 1/4" H (17.8 x 8.3 cm)
- MWMSQ9** 127 oz. (3.8 L)
9 1/2" Sq. x 4" H (24.1 x 10.2 cm)
- MWMSQ11** 232 oz. (6.9 L)
12" Sq. x 4 1/2" H (30.5 x 11.4 cm)



Shown with GVHT2 tongs



Shown with GVHT1 tongs

MWB14

MWB12

MWB11



MW32

NEW

MW24

MW18

White Marble Melamine Serving Bowls

BPA FREE

With the look of high-end marble and the durability of melamine, these generously-sized serving bowls are made to be true crowd pleasers. From salads to sides, these bowls provide an elegant backdrop to any group dining event.

MWB11 97 oz. (2.9 L)
11" Dia. x 3 1/8" H
(27.9 x 7.9 cm)

MWB12 137 oz. (4.1 L)
12 3/4" Dia. x 3 3/8" H
(32.4 x 8.6 cm)

MWB14 235 oz. (6.9 L)
14 3/4" Dia. x 3 1/2" H
(37.5 x 8.9 cm)

White Marble Flat Melamine Serving Platters

NEW

BPA FREE

Achieve the stately look of white marble on your buffet line or grazing table without compromising lightweight and dishwasher-safe convenience. These melamine platters are stunningly elegant and equally practical. They pair perfectly with our Black Twilight Modular Risers for a knockout presentation.

MW18 17 3/4" L x 8 3/4" W x 5/8" H
(45.1 x 22.2 x 1.6 cm)

MW24 24" L x 8 3/4" W x 5/8" H
(61 x 22.2 x 1.6 cm)

MW32 31 1/2" L x 8 3/4" W x 5/8" H
(80 x 22.2 x 1.6 cm)

Marble Melamine Serving Boards

White

- MW17** Organic
17 3/8" L x 9 7/8" W x 5/8" H
(44.1 x 25.1 x 1.6 cm)
- MW14** Round
14" Dia. x 1 1/8" H
(35.6 x 2.9 cm)
- MW25** Oval
25 1/2" L x 10 1/4" W x 1 1/8" H
(64.8 x 26 x 2.9 cm)
- MW171** Round
17 1/4" Dia. x 1 1/8" H
(43.8 x 2.9 cm)
- MW21** Round
21 1/2" Dia. x 1 1/8" H
(54.6 x 2.9 cm)

Black

- MB17** Organic
17 3/8" L x 9 7/8" W x 5/8" H
(44.1 x 25.1 x 1.6 cm)
- MB14** Round
14" Dia. x 1 1/8" H
(35.6 x 2.9 cm)
- MB25** Oval
25 1/2" L x 10 1/4" W x 1 1/8" H
(64.8 x 26 x 2.9 cm)
- MB171** Round
17 1/4" Dia. x 1 1/8" H
(43.8 x 2.9 cm)
- MB21** Round
21 1/2" Dia. x 1 1/8" H
(54.6 x 2.9 cm)

A PRACTICAL, STYLISH ALTERNATIVE
TO REAL MARBLE

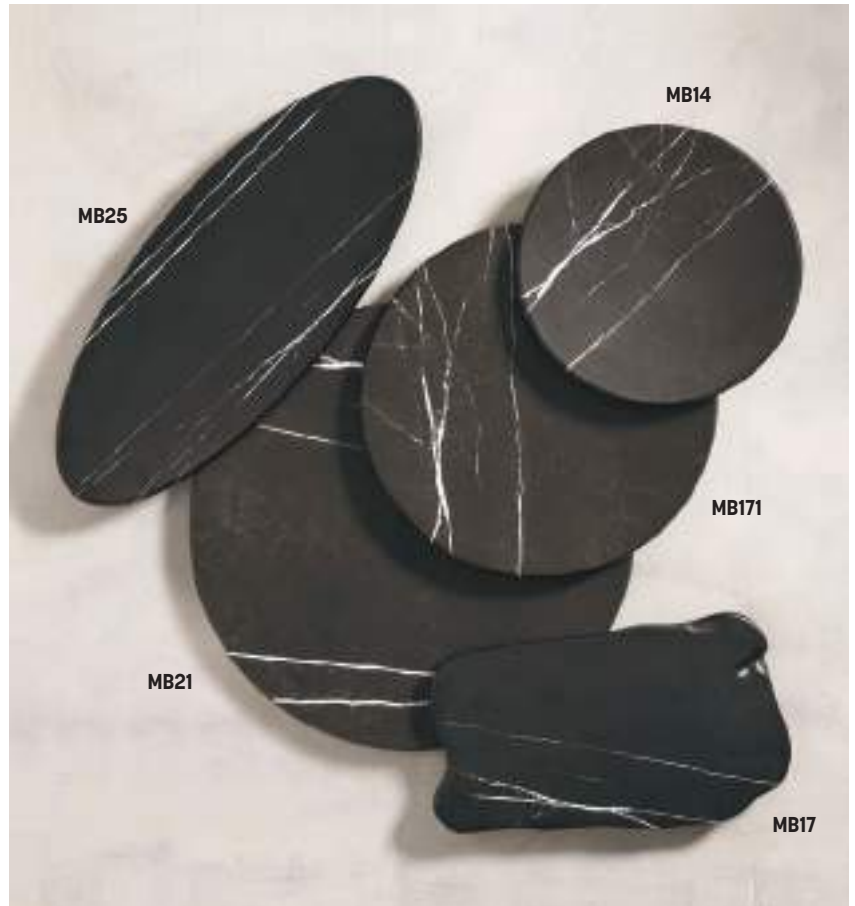



GM1614

GM210

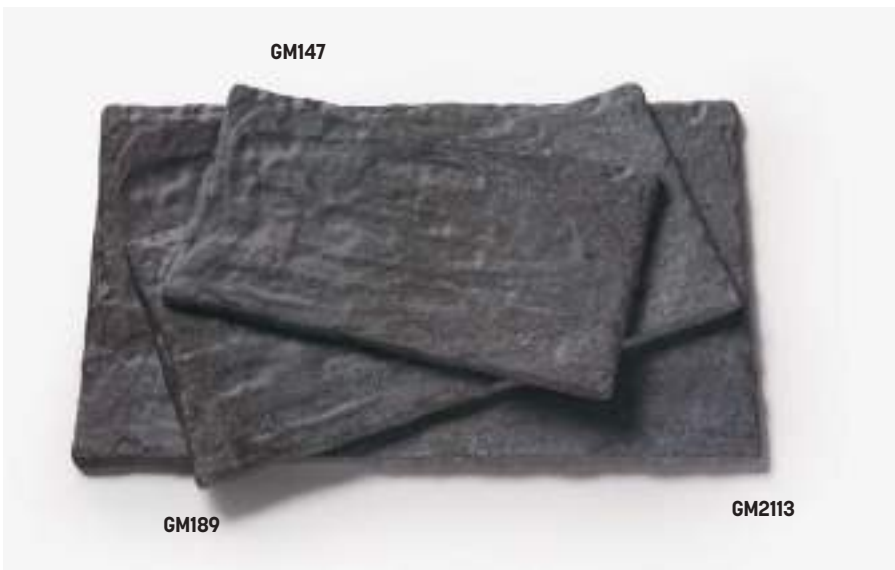

GM147

GM189

GM2113

Greystone Melamine Serving Boards

Your customers will swear that these melamine serving boards and risers are chiseled from stone.

GM1614 Organic Round
16 3/8" L x 14 5/8" W x 5/8" H
(41.6 x 37.1 x 1.6 cm)

GM210 Organic Oblong
21 1/4" L x 10 5/8" W x 5/8" H
(54 x 27 x 1.6 cm)

GM147 Rectangular
14 1/4" L x 8" W x 3/8" H
(36.2 x 20.3 x 1 cm)

GM189 Rectangular
17 3/4" L x 8 3/4" W x 3/8" H
(45.1 x 22.2 x 1 cm)

GM2113 Rectangular
21 3/8" L x 12 3/4" W x 3/8" H
(54.3 x 32.4 x 1 cm)



GM95

GM13

Greystone Melamine Risers

GM95 Round
10 1/8" Dia. x 2 1/8" H
(25.7 x 5.4 cm)

GM13 Rectangular
12 1/4" L x 6 3/4" W x 2" H
(31.1 x 17.1 x 5.1 cm)

Olive Wood Melamine

Serving Boards 

OWM17 Organic
17 3/8" L x 9 7/8" W x 5/8" H
(44.1 x 25.1 x 1.6 cm)

OWM14 Round
14" Dia. x 1 1/8" H
(35.6 x 2.9 cm)

OWM25 Oval
25 1/2" L x 10 1/4" W x 1 1/8" H
(64.8 x 26 x 2.9 cm)

OWM171 Round
17 1/4" Dia. x 1 1/8" H
(43.8 x 2.9 cm)

OWM21 Round
21 1/2" Dia. x 1 1/8" H
(54.6 x 2.9 cm)

Olive Wood Melamine

Serving Peels 

OWM12 Rectangular
12" L x 6" W x 1/2" H
17 1/2" L with Handle
(30.5 x 15.2 x 1.3, 44.5 cm)

OWM10 Square
10" L x 9" W x 1/2" H
14 1/2" L with Handle
(25.4 x 22.9 x 1.3, 36.8 cm)





Shown with GVHT2 tongs

Reclaimed Wood Melamine

Serving Bowls BPA FREE

We took the natural styling of our Reclaimed Wood Melamine Serving Boards and applied it to bowls, creating a great opportunity for cohesive presentation. The exterior of the bowls is wood-textured to complement the unique faux-weathered interior.

- RMB11** 97 oz. (2.9 L)
11" Dia. x 3 1/8" H
(27.9 x 7.9 cm)
- RMB12** 137 oz. (4.1 L)
12 3/4" Dia. x 3 3/8" H
(32.4 x 8.6 cm)
- RMB14** 235 oz. (6.9 L)
14 3/4" Dia. x 3 1/2" H
(37.5 x 8.9 cm)

Reclaimed Wood Melamine

Serving Boards BPA FREE

The on-trend look of reclaimed wood meets the durable functionality of melamine with our serving boards, peels and risers. All of the style, none of the impracticality.

- RM17** Organic
17 3/8" L x 9 7/8" W x 5/8" H
(44.1 x 25.1 x 1.6 cm)
- RM14** Round
14" Dia. x 1 1/8" H
(35.6 x 2.9 cm)
- RM25** Oval
25 1/2" L x 10 1/4" W x 1 1/8" H
(64.8 x 26 x 2.9 cm)
- RM21** Round
21 1/2" Dia. x 1 1/8" H
(54.6 x 2.9 cm)

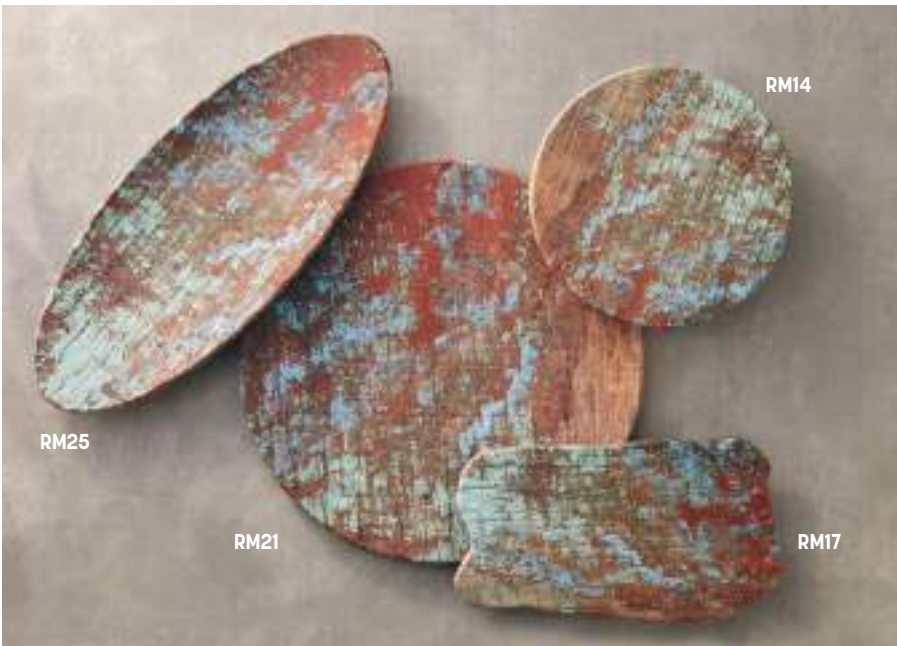

Reclaimed Wood Melamine

Serving Peels BPA FREE

- RM12** Rectangular
12" L x 6" W x 1/2" H
17 1/2" L with Handle
(30.5 x 15.2 x 1.3, 44.5 cm)
- RM10** Square
10" L x 9" W x 1/2" H
14 1/2" L with Handle
(25.4 x 22.9 x 1.3, 36.8 cm)





**Reclaimed Wood
Melamine Serving Boards** BPA
FREE

- RM147** Rectangular
14 1/4" L x 8" W x 3/8" H
(36.2 x 20.3 x 1 cm)
- RM189** Rectangular
17 3/4" L x 8 3/4" W x 3/8" H
(45.1 x 22.2 x 1 cm)
- RM2113** Rectangular
21 3/8" L x 12 3/4" W x 3/8" H
(54.3 x 32.4 x 1 cm)
- RM1614** Organic Round
16 3/8" L x 14 5/8" W x 5/8" H
(41.6 x 37.1 x 1.6 cm)
- RM210** Organic Oblong
21 1/4" L x 10 5/8" W x 5/8" H
(54 x 27 x 1.6 cm)



**Reclaimed Wood
Melamine Risers** BPA
FREE

- RM95** Round
10 1/8" Dia. x 2 1/8" H
(25.7 x 5.4 cm)
- RM13** Rectangular
12 1/4" L x 6 3/4" W x 2" H
(31.1 x 17.1 x 5.1 cm)





AWM25

AWM14

AWM21

AWM171

AWM17

PERFECT FOR FARM-TO-TABLE



ROUND AND OVAL SERVING
BOARDS FEATURE
INCONSPICUOUS 1 1/8" FEET
FOR CONVENIENT SERVING

Acacia Melamine Serving Boards BPA FREE

AWM17 Organic
17 3/8" L x 9 7/8" W x 5/8" H
(44.1 x 25.1 x 1.6 cm)

AWM14 Round
14" Dia. x 1 1/8" H
(35.6 x 2.9 cm)

AWM25 Oval
25 1/2" L x 10 1/4" W x 1 1/8" H
(64.8 x 26 x 2.9 cm)

AWM171 Round
17 1/4" Dia. x 1 1/8" H
(43.8 x 2.9 cm)

AWM21 Round
21 1/2" Dia. x 1 1/8" H
(54.6 x 2.9 cm)

Acacia Melamine Serving Peels BPA FREE

AWM12 Rectangular
12" L x 6" W x 1/2" H
17 1/2" L with Handle
(30.5 x 15.2 x 1.3, 44.5 cm)

AWM10 Square
10" L x 9" W x 1/2" H
14 1/2" L with Handle
(25.4 x 22.9 x 1.3, 36.8 cm)



AWM10

AWM12

NEW



Acacia Melamine

Serving Bowls

NEW BPA FREE

With the look of acacia wood matched with the durability of melamine, these generous-sized serving bowls are made to be true crowd-pleasers. From salads to sides, these bowls provide an elegant backdrop to any group dining event.

- AWMB11** 97 oz. (2.9 L)
11" Dia. x 3 1/8" H
(27.9 x 7.9 cm)
- AWMB12** 137 oz. (4.1 L)
12 3/4" Dia. x 3 3/8" H
(32.4 x 8.6 cm)
- AWMB14** 235 oz. (6.9 L)
14 3/4" Dia. x 3 1/2" H
(37.5 x 8.9 cm)

Wood Melamine Serving Boards

BPA FREE

- MPLB** Bamboo
20 7/8" L x 12 1/2" W x 3/8" H
(53 x 31.8 x 1 cm)
- MPLW** Walnut
20 7/8" L x 12 1/2" W x 3/8" H
(53 x 31.8 x 1 cm)
- MPLA** Elm
20 7/8" L x 12 1/2" W x 3/8" H
(53 x 31.8 x 1 cm)

MPLB



MPLW



MPLA





Rectangular Walnut Melamine Platters BPA FREE

- WMEL19** 14 ¼" L x 7 ½" W x 1 ½" H
(36.2 x 19.1 x 3.8 cm)
- WMEL23** 18" L x 8 7⁄8" W x 2" H
(45.7 x 22.5 x 5.1 cm)
- WMEL21** 21 3⁄8" L x 13" W x 1 3⁄4" H
(54.3 x 33 x 4.4 cm)

Black and White Melamine Serving Trays BPA FREE

You can't go wrong with a timeless black and white color scheme. Perfect for food halls, marketplaces and quick serve restaurants, these lightweight, dishwasher-safe trays are the perfect carrying case for your meal.

- MTB20** Black
19 3⁄8" L x 12 ½" W x 1" H
(49.2 x 31.8 x 2.5 cm)
- MTW20** White
19 3⁄8" L x 12 ½" W x 1" H
(49.2 x 31.8 x 2.5 cm)



Shown with NSB10 number stand,
MSCSW3 sauce cup and MCB36WH bowl

MTB20

MTW20



Tapered Birch Bread Baskets

Available in our most popular sizes, these real wooden pieces perform double duty as baskets or risers.

- TWBB53** 5" Sq. x 3" H
(12.7 x 7.6 cm)
- TWBB73** 7" Sq. x 3 ¼" H
(17.8 x 8.3 cm)
- TWBB94** 9 ½" Sq. x 4" H
(24.1 x 10.2 cm)
- TWBB124** 12" Sq. x 4 ½" H
(30.5 x 11.4 cm)
- TWBREC** 9 ¼" L x 6 ¼" W x 3" H
(23.5 x 15.9 x 7.6 cm)





THE BAMBOO COLLECTION

Go green without sacrificing looks with environmentally friendly bamboo. Warm wood-like tones make this collection a casual way to elevate breakfast buffets, catering, room service and more.

Carbonized Bamboo Serving Boards **HOT**

BWB105 10" L x 5 3/4" W x 3/4" H
(25.4 x 14.6 x 1.9 cm)

BWB109 10" L x 9" W x 3/4" H
(25.4 x 22.9 x 1.9 cm)

BWB185 18 1/4" L x 5 3/4" W x 3/4" H
(46.4 x 14.6 x 1.9 cm)

BWB189 18 1/4" L x 9" W x 3/4" H
(46.4 x 22.9 x 1.9 cm)

Carbonized Bamboo Flight Boards

BWF4 Flight Board
13 7/8" L x 3 3/8" W x 1 1/4" H
(35.2 x 8.6 x 3.2 cm)

BWF3 Pairing Flight Board
13 7/8" L x 6 7/8" W x 1 1/4" H
(35.2 x 17.5 x 3.2 cm)



BWBO shown with MB4 sauce cup

Shown with GMB8 milk bottles

BWBR

Carbonized Bamboo Serving Peels and Boards

Serving Boards

BWBR Round
9" Dia. x ¾" H
(22.9 x 1.9 cm)

BWBO Oblong
13 ½" L x 6" W x ¾" H
(34.3 x 15.2 x 1.9 cm)

Serving Peels

BWBS Rectangular
9 ¼" L x 5" W x ¾" H
13 ¼" L with Handle
(23.5 x 12.7 x 1.9, 33.7 cm)

BWBL Rectangular
15" L x 7" W x ¾" H
19" L with Handle
(38.1 x 17.8 x 1.9, 48.3 cm)



Shown with HMMJ5 apothecary jar

BWBL

ALL OF OUR CARBONIZED SERVING PIECES FEATURE A RICH WOOD PATINA THAT IS LIGHT BROWN ON ONE SIDE AND DARK BROWN ON THE OTHER

BWBS shown with CKNF2 cheese knife



BAM18 shown with
PBSL2 liner and
FRYR375 fry basket

BAM1812

BAM22

BAM14

Rectangular Bamboo Trays

- BAM14** 14 ¼" L x 7 ½" W x 1 ½" H
(36.2 x 19.1 x 3.8 cm)
- BAM18** 18 ⅛" L x 9 ⅛" W x 2" H
(46 x 23.2 x 5.1 cm)
- BAM1812** 18" L x 12" W x 2" H
(45.7 x 30.5 x 5.1 cm)
- BAM22** 21 ¾" L x 13 ⅛" W x 2" H
(55.2 x 33.3 x 5.1 cm)

Disposable Liners

- PBSL1** 13 ¾" L x 7 ¼" W x 1" H
(34.9 x 18.4 x 2.5 cm)
PET Liner for BAM14
- PBSL2** 17 ½" L x 8 ¾" W x 2" H
(44.5 x 22.2 x 5.1 cm)
PET Liner for BAM18
- PBSL3** 19 ½" L x 12" W x 2" H
(49.5 x 30.5 x 5.1 cm)
PET Liner for BAM22

Flat Bamboo Platters

- BAM148** 14 ½" L x 8 ¼" W x ⅞" H
(36.8 x 21 x 2.2 cm)
- BAM189** 18 ¼" L x 9" W x ⅞" H
(46.4 x 22.9 x 2.2 cm)
- BAM141** 14 ⅜" Sq. x ⅞" H
(36.5 x 2.2 cm)
- BAM211** 21 ½" L x 13" W x ⅞" H
(54.6 x 33 x 2.2 cm)



BAM211

BAM148

BAM189

BAM141

Round Bamboo Butcher Blocks

- B10** 10" Dia. x 1 1/2" H
(25.4 x 3.8 cm)
- B12** 12" Dia. x 1 1/2" H
(30.5 x 3.8 cm)
- B14** 14" Dia. x 1 1/2" H
(35.6 x 3.8 cm)
- B16** 16" Dia. x 1 1/2" H
(40.6 x 3.8 cm)



Square Bamboo Bowls

- BAM53** 23 oz. (680.2 mL)
5" Sq. x 3" H
(12.7 x 7.6 cm)
- BAM73** 58 oz. (1.7 L)
7" Sq. x 3 1/4" H
(17.8 x 8.3 cm)
- BAM94** 125 oz. (3.7 L)
9 1/2" Sq. x 4" H
(24.1 x 10.2 cm)
- BAM124** 202 oz. (6 L)
12" Sq. x 4 1/2" H
(30.5 x 11.4 cm)



Angled Bamboo Bowls

- BAMSL52** 8 oz. (236.6 mL)
5" Dia. x 3 1/2" H
(12.7 x 8.9 cm)
- BAMSL82** 22 oz. (650.6 mL)
8 1/4" Dia. x 5 3/8" H
(21 x 13.7 cm)
- BAMSL92** 48 oz. (1.4 L)
9 3/4" Dia. x 6 1/8" H
(24.8 x 15.6 cm)
- BAMSL112** 80 oz. (2.4 L)
11 1/2" Dia. x 7 1/4" H
(29.2 x 18.4 cm)





AWB10

AWB12

AWB7 shown with
HS2 oval hammered sauce cup
and CKNF7 soft cheese spreader



AWB1210

AWB147

THE ASH WOOD COLLECTION

These ash wood boards and peels feature rich patterns, earthy looks and unique handle designs. From charcuterie to single serving sandwiches, there's a size for every need. See pg. 458-459 for special care instructions.

Rimmed Oval Ash Wood Serving Boards

- AWB7 7" L x 4" W x ¾" H
(17.8 x 10.2 x 1.9 cm)
- AWB10 9" L x 6" W x ¾" H
(22.9 x 15.2 x 1.9 cm)
- AWB12 12" L x 9" W x ¾" H
(30.5 x 22.9 x 1.9 cm)

Rimmed Ash Wood Serving Boards

- AWB147 14" L x 7" W x ¾" H
(35.6 x 17.8 x 1.9 cm)
- AWB1210 12" L x 10" W x ¾" H
(30.5 x 25.4 x 1.9 cm)

Ash Wood Rectangular Serving Boards

- AWB1016** 16" L x 10" W x ¾" H
(40.6 x 25.4 x 1.9 cm)
- AWB621** 21" L x 6" W x ¾" H
(53.3 x 15.2 x 1.9 cm)
- AWB1021** 21" L x 10" W x ¾" H
(53.3 x 25.4 x 1.9 cm)

Ash Wood Serving Peels

- AWB617** 12" L x 6" W x ¾" H
17" L with Handle
(30.5 x 15.2 x 1.9, 43.2 cm)
- AWB179** 12" L x 9" W x ¾" H,
17" L with Handle
(30.5 x 22.9 x 1.9, 43.2 cm)



AWB1021

AWB1016

Shown with
HCHL1 hammered
card holder and
TAGA8WT mini
chalk card

AWB621



AWB617

AWB179



MWP13 shown with LFTD12

MWP12 shown with LFTD11

MWPD5

MWPD6

LFTD8

MWP4 shown with LFTD3

MWP5 shown with LFTD4

MWP9



MWP13

MWP12

MWP4

MWP9

MWP5

THE UPTON COLLECTION

In today's world where we eat with our eyes, visual display is key. Enter the Upton Collection: A mix of espresso-finished wood display items perfectly paired with crystal clear domes. The result is a head-turning, rich display sure to catch customer attention.

Upton Collection Plates

Handcrafted, espresso-finished wood plates and platters are perfectly rimmed to frame any menu option. From baked goods to cheese plates, these wood boards will complement any food pairing.

MWP4 4 ¼" Dia. x ¾" H
(10.8 x 1.9 cm)

MWP5 5" Dia. x ¾" H
(12.7 x 1.9 cm)

MWP9 9" Dia. x ¾" H
(22.9 x 1.9 cm)

MWP12 12" Dia. x ¾" H
(30.5 x 1.9 cm)

MWP13 13" Dia. x ¾" H
(33 x 1.9 cm)

MWP14 14 ¼" L x 6 ⅝" W x 1" H
(36.2 x 16.8 x 2.5 cm)



Shown with GVHT6 tongs

NEW

MWP14 shown with LFTD135

NEW

Upton Collection Platters NEW

Give your charcuterie spreads and grazing tables an elegant boost with these stately espresso platters from the Upton Collection. They pair perfectly with our Black Twilight Modular Risers for a knockout presentation.

MWP18 17 ¾" L x 8 ¾" W x 7/8" H
(45.1 x 22.2 x 2.2 cm)

MWP24 24" L x 8 ¾" W x 7/8" H
(61 x 22.2 x 2.2 cm)

MWP32 32" L x 8 ¾" W x 7/8" H
(81.3 x 22.2 x 2.2 cm)

Upton Collection Pedestals

Elegant and beautiful, our Upton Collection pedestals can really be considered works of art. Handcrafted to provide height and beauty to any display. Use with an Upton Collection plate or a clear dome to finish the look.

MWPD5 7" Top Dia. x 5 ¼" H
(17.8 x 13.3 cm)

MWPD6 9" Top Dia. x 6 ¼" H
(22.9 x 15.9 cm)

Clear Domes !

LFTD3 3 ⅝" Dia. x 3 ½" H
(8.6 x 8.9 cm)

LFTD4 4 ⅞" Dia. x 3 ⅞" H
(10.5 x 9.8 cm)

LFTD8 8 ⅞" Dia. x 6 ⅝" H
(20.6 x 16.8 cm)

LFTD11 11" Dia. x 8 ⅝" H
(27.9 x 21.9 cm)

LFTD12 12 ⅞" Dia. x 9 ⅞" H
(30.8 x 23.2 cm)

LFTD135 13 ½" L x 5 ⅞" W x 8" H
(34.3 x 14.9 x 20.3 cm)

NEW

WARNING: This product can expose you to chemicals including Bisphenol A (BPA), which is known to the State of California to cause birth defects or other reproductive harm. For more information, go to www.P65warnings.ca.gov. Warning applies to State of California only.



THE OLIVE WOOD COLLECTION

Whether you choose our striking geometric style or our wavy organic style, you'll have a board with gorgeous marbling and memorable design. No two boards are exactly alike.

Short-Handle Olive Wood Serving Peels

- OWP9** 8" W x 9" L Blade
14" with Handle
(20.3 x 22.9, 35.6 cm)
- OWP13** 12" W x 13" L Blade
22" with Handle
(30.5 x 33, 55.9 cm)
- OWP15** 14" W x 15" L Blade
24" with Handle
(35.6 x 38.1, 61 cm)
- OWP17** 16" W x 17" L Blade
26" with Handle
(40.6 x 43.2, 66 cm)

Olive Wood Serving Peels

- OWB116** 9 1/4" L x 6" W x 5/8" H
10 3/4" L with Handle
(23.5 x 15.2 x 1.6, 27.3 cm)
- OWB117** 9 3/8" L x 5 3/4" W x 5/8" H
12 1/8" L with Handle
(23.8 x 14.6 x 1.6, 30.8 cm)
- OWB118** 13 7/8" L x 5 7/8" W x 5/8" H
16 1/8" L with Handle
(35.2 x 14.9 x 1.6, 41 cm)
- OWB149** 9 7/8" L x 9 1/8" W x 5/8" H
14" L with Handle
(25.1 x 23.2 x 1.6, 35.6 cm)

Organic Olive Wood Serving Peels

- OWP157** 10 3/4" L x 7" W x 3/4" H
14 3/4" L with Handle
(27.3 x 17.8 x 1.9, 37.5 cm)
- OWP178** 12 1/8" L x 7 3/4" W x 3/4" H
17 3/8" L with Handle
(30.8 x 19.7 x 1.9, 44.1 cm)





Olive Wood Polyresin Serving Boards

A showstopping way to serve hors d'oeuvres and charcuteries. These high-end, food-safe serving boards infuse stunning olive wood with a streak of vibrant blue polyresin.

- OWP14** 14" L x 7" W x $\frac{5}{8}$ " H
(35.6 x 17.8 x 1.6 cm)
- OWP12** 12" L x 10" W x $\frac{5}{8}$ " H
(30.5 x 25.4 x 1.6 cm)
- OWP18** 18" L x 10" W x $\frac{5}{8}$ " H
(45.7 x 25.4 x 1.6 cm)

Large Olive Wood Serving Boards

- OWB1810** 18" L x 9 $\frac{1}{8}$ " W x $\frac{3}{4}$ " H
(45.7 x 23.2 x 1.9 cm)
- OWB208** 20" L x 8" W x $\frac{3}{4}$ " H
(50.8 x 20.3 x 1.9 cm)
- OWB2213** 22" L x 13" W x $\frac{3}{4}$ " H
(55.9 x 33 x 1.9 cm)



Shown with HMMJ3, HMMJ2, HMMJ5 apothecary jars

OWB1810 on GJ24 glass jar risers

Shown with GJ8 glass jars



Olive Wood Serving Boards

OWB107 10" L x 7" W x ¾" H
(25.4 x 17.8 x 1.9 cm)

OWB129 12" L x 9" W x ¾" H
(30.5 x 22.9 x 1.9 cm)

Oblong Olive Wood Boats

OWSP 12" L x 4 ½" W x 1" H
(30.5 x 11.4 x 2.5 cm)

OWMP 17 ¾" L x 5 ¼" W x 1 ¼" H
(45.1 x 13.3 x 3.2 cm)

OWLP 23 ⅝" L x 5 ⅞" W x 1 ¼" H
(60 x 14.9 x 3.2 cm)

Shown with
MJ17 and GJ6
glass jars





Shown with
MJ85 mason jar

OWPB16

OWPB9

Oval Olive Wood Serving Boards

OWPB9 9 7/8" L x 5 7/8" W x 1/2" H
(25.1 x 14.9 x 1.3 cm)

OWPB16 16 1/8" L x 7 1/8" W x 1/2" H
(41 x 18.1 x 1.3 cm)

Olive Wood Bread Crates

OWBB1 8 1/2" L x 4" W x 2 3/8" H
(21.6 x 10.2 x 6 cm)

OWBB2 8" L x 6" W x 2 3/8" H
(20.3 x 15.2 x 6 cm)



OWBB2

OWBB1

FLIP CRATES OVER TO
USE THEM AS RISERS



Olive Wood/Marble Serving Peels

Gray Marble

OWBG8 6" L x 3 1/2" W x 1/2" H
8" L with Handle
(15.2 x 8.9 x 1.3, 20.3 cm)

OWBG9 5 5/8" L x 5 1/4" W x 1/2" H
9" L with Handle
(14.3 x 13.3 x 1.3, 22.9 cm)

OWBG15 10" L x 9" W x 1/2" H
14 3/4" L with Handle
(25.4 x 22.9 x 1.3, 37.5 cm)

Black Marble

OWBB8 6" L x 3 1/2" W x 1/2" H
8" L with Handle
(15.2 x 8.9 x 1.3, 20.3 cm)

OWBB9 5 5/8" L x 5 1/4" W x 1/2" H
9" L with Handle
(14.3 x 13.3 x 1.3, 22.9 cm)

OWBB15 10" L x 9" W x 1/2" H
14 3/4" L with Handle
(25.4 x 22.9 x 1.3, 37.5 cm)





Loft Collection Acacia Wood Serving Boards

Plate up anything from pizzas to charcuterie in these beautifully grained wood boards. Made of durable acacia wood, each board is double-sided for versatility in serving. Pair with risers and accessories from the Loft Collection for a complete look.

- ATP10** 10" Dia. x 5/8" H
(25.4 x 1.6 cm)
- ATP12** 12" Dia. x 5/8" H
(30.5 x 1.6 cm)
- ATP14** 14" Dia. x 5/8" H
(35.6 x 1.6 cm)
- ATP16** 16" Dia. x 5/8" H
(40.6 x 1.6 cm)

Acacia Wood Serving Platters

Acacia wood adds a touch of rustic beauty to any buffet line or grazing table. These organically-edged platters will easily boost the look of any charcuterie board or display. They pair perfectly with our Black Twilight Modular Risers for a knockout presentation.

- AB189** 17 3/4" L x 8 3/4" W x 3/4" H
(45.1 x 22.2 x 1.9 cm)
- AB249** 24" L x 8 3/4" W x 3/4" H
(61 x 22.2 x 1.9 cm)
- AB329** 32" L x 8 3/4" W x 3/4" H
(81.3 x 22.2 x 1.9 cm)





MBM4 shown with GJ6 jar

Maple Pressed Wood Serving Peels ^{USA}

A beautiful maple veneer gives these peels the look and feel of wood, but they're also dishwasher-safe. Use them anywhere you'd use a traditional plate.

Rectangular

MBM2 12 1/2" L x 4 3/8" W x 1/4" H
18" L with Handle
(31.8 x 11.1 x 0.6, 45.7 cm)

MBM3 12 1/2" L x 6 1/2" W x 1/4" H
18" L with Handle
(31.8 x 16.5 x 0.6, 45.7 cm)

MBM4 13" L x 8 1/8" W x 1/4" H
18" L with Handle
(33 x 20.6 x 0.6, 45.7 cm)

Round

MBM180 18" Dia. x 1/4" H
28 1/2" L with Handle
(45.7 x 0.6, 72.4 cm)



MBM4

MBM3

MBM2



USA

MBM180

REPLACE TRADITIONAL PLATES
WITH CREATIVE SERVING PEELS

Maple Pressed Wood**Serving Boards** 

A beautiful maple veneer gives these boards the look and feel of wood, but they're also dishwasher-safe. Perfect for flatbreads

- MBSB11** 11" L x 7" W x ¼" H
(27.9 x 17.8 x 0.6 cm)
- MBSB17** 17" L x 9" W x ¼" H
(43.2 x 22.9 x 0.6 cm)
- MBSB20** 19" L x 9" W x ¼" H
(48.3 x 22.9 x 0.6 cm)

Black Pressed Wood**Serving Boards**

Made of natural wood fiber material, this black serving board is the perfect companion to our Mega Flatbread Screens.

- MPSB16** 16" L x 8" W x ¼" H
(40.6 x 20.3 x 0.6 cm)

Rectangular Wood**Serving Peels** 

- MSB2** 12 ½" L x 4 ¾" W x ⅝" H
18" L with Handle
(31.8 x 11.1 x 1.6, 45.7 cm)
- MSB3** 12 ½" L x 6 ½" W x ⅝" H
18" L with Handle
(31.8 x 16.5 x 1.6, 45.7 cm)
- MSB4** 13" L x 8 ⅝" W x ⅝" H
18" L with Handle
(33 x 20.6 x 1.6, 45.7 cm)

Heavy Rubber Wood**Bread Boards** 

- BB812** 9" L x 8 ⅝" W x ¾" H
12 ½" L with Handle
(22.9 x 20.6 x 1.9, 31.8 cm)
- BB816** 10 ⅝" L x 8 ⅝" W x ¾" H
16 ¼" L with Handle
(25.7 x 20.6 x 1.9, 41.3 cm)



BB816

BB812



MBSB17

USA

MBSB20

MBSB11



MPSB16



MSB2

MSB3

MSB4

STYLISH ENOUGH FOR FRONT-OF-HOUSE,
DURABLE ENOUGH FOR BACK-OF-HOUSE



HOT

SB7

SB5

SB3



SB575

SB450

SB400

SB325

Squound Stainless Steel Bowls HOT

Pair stainless steel with a mix of round and square shapes, and you get some of the most contemporary serving bowls on the market.

- SB3** 40 oz. (1.2 L)
7" Dia. x 2 1/8" H (17.8 x 5.4 cm)
- SB5** 67 oz. (2 L)
9" Dia. x 2 3/4" H (22.9 x 7 cm)
- SB7** 126 oz. (3.7 L)
11" Dia. x 3" H (27.9 x 7.6 cm)

Squound Stainless Steel Snack Bowls

- SB325** 3 oz. (88.7 mL)
3 1/8" Dia. x 1 1/2" H (7.9 x 3.8 cm)
- SB400** 5 1/2 oz. (162.7 mL)
3 3/4" Dia. x 1 5/8" H (9.5 x 4.1 cm)
- SB450** 9 1/2 oz. (280.9 mL)
4 1/2" Dia. x 2" H (11.4 x 5.1 cm)
- SB575** 15 oz. (443.6 mL)
5 3/4" Dia. x 2 1/2" H (14.6 x 6.4 cm)



SB1

Round Checker Bowl

With tasteful square cutouts, this brushed stainless steel bowl is a great way to add instant intrigue to baked goods.

- SB1** Checker
8" Dia. x 3 5/8" H (20.3 x 9.2 cm)



Squound Hammered Bowls

| | |
|-------------|--|
| SBH3 | 40 oz. (1.2 L) 7" Dia. x 2 1/8" H (17.8 x 5.4 cm) |
| SBH5 | 67 oz. (2 L) 9" Dia. x 2 3/4" H (22.9 x 7 cm) |
| SBH7 | 126 oz. (3.7 L) 11" Dia. x 3" H (27.9 x 7.6 cm) |

Squound Hammered Snack Bowls

| | |
|---------------|---|
| SBH325 | 3 oz. (88.7 mL) 3 1/8" Dia. x 1 1/2" H (7.9 x 3.8 cm) |
| SBH400 | 5 1/2 oz. (162.7 mL) 3 3/4" Dia. x 1 5/8" H (9.5 x 4.1 cm) |
| SBH450 | 9 1/2 oz. (280.9 mL) 4 1/2" Dia. x 2" H (11.4 x 5.1 cm) |
| SBH575 | 15 oz. (443.6 mL) 5 3/4" Dia. x 2 1/2" H (14.6 x 6.4 cm) |



Shown with MSTNG5 tongs

Moroccan Hammered Bowls

These one-of-a-kind stainless steel bowls are great serving vessels for global cuisine and practically anything else.

| | |
|------------|---|
| HB5 | 16 oz. (473.2 mL) 5" Dia. x 2" H (12.7 x 5.1 cm) |
| HB6 | 27 oz. (798.5 mL) 6" Dia. x 2 1/2" H (15.2 x 6.4 cm) |
| HB7 | 38 oz. (1.1 L) 6 3/4" Dia. x 2 3/4" H (17.1 x 7 cm) |



Shown with SPM4 S&P shakers



NEW

NHS95

NHS66

Stainless Steel Napkin Holders NEW

Modern and sleek, these napkin holders offer a functional design that keeps both full and bar-sized napkins neatly in place, even for outdoor events.

NHS66 6" Sq. x 5" H
(15.2 x 12.7 cm)

NHS95 9" L x 5" W x 5" H
(22.9 x 12.7 x 12.7 cm)

Satin Finish Stainless Steel Trays with Sides

ST10 10" L x 4 1/2" W x 1/2" H
(25.4 x 11.4 x 1.3 cm)

ST12 12" L x 8 1/4" W x 1/2" H
(30.5 x 21 x 1.3 cm)

ST20 20 1/8" L x 4 1/2" W x 1/2" H
(51.1 x 11.4 x 1.3 cm)



Shown with FFCCS45 fry cup and PPRN76 paper bag

ST20

ST10

ST12

Royal Touch™ Round Serving Trays

The name says it all. These heavy-duty stainless steel trays elevate catered events to glamorous affairs with their elegantly embossed design.

SST10 10" Dia. x 1/2" H
(25.4 x 1.3 cm)

SST12 12" Dia. x 1/2" H
(30.5 x 1.3 cm)

SST14 14" Dia. x 1/2" H
(35.6 x 1.3 cm)



SST14

SST12

SST10

THE HAMMERED COLLECTION

Snowflakes, fingerprints and pieces from our Hammered Collection. The connection? Each is one-of-a-kind. These stainless steel trays and bowls are individually hammered with a ball-peen hammer so that each is uniquely stunning.

Hammered Stainless Steel Trays with Sides

HMST10 10" L x 4 1/2" W x 1/2" H
(25.4 x 11.4 x 1.3 cm)

HMST12 12" L x 8 1/4" W x 1/2" H
(30.5 x 21 x 1.3 cm)

HMST20 20 1/8" L x 4 1/2" W x 1/2" H
(51.1 x 11.4 x 1.3 cm)

Hammered Stainless Steel Sheet Pans

Prep, store and serve, all with one super-versatile pan. From the kitchen to the dining room, this jack-of-all-trades gets the job done.

HMSP1813 Half-Size
18" L x 13" W x 1" H
(45.7 x 33 x 2.5 cm)

HMSP2618 Full-Size
26" L x 18" W x 1" H
(66 x 45.7 x 2.5 cm)



HMST10

HMST20



HMST12 with
FRYS443 fry basket
and HAMSC sauce cup



HMSP1813

HMSP2618

IN YOUR CHOICE OF FULL AND
HALF SIZES THAT STORE EASILY
IN YOUR EVERYDAY SPEED RACK

HMRD16



HMRD08



HMRD12



Round Hammered Bowls

- HMRD08** 34 oz. (1 L)
8 1/2" Dia. x 1 5/8" H
(21.6 x 4.1 cm)
- HMRD12** 85 oz. (2.5 L)
12 1/8" Dia. x 2 1/4" H
(30.8 x 5.7 cm)
- HMRD16** 168 oz. (5 L)
16 1/4" Dia. x 2 3/4" H
(41.3 x 7 cm)

Oval Hammered Trays

- HMOST1115** 15" L x 11" W x 3/4" H
(38.1 x 27.9 x 1.9 cm)
- HMOST1317** 17 1/4" L x 13 1/4" W x 1 1/8" H
(43.8 x 33.7 x 2.9 cm)
- HMOST1520** 20" L x 15 1/2" W x 1 1/8" H
(50.8 x 39.4 x 2.9 cm)

Oval Hammered Bowls

- HMOV1418** 144 oz. (4.3 L)
18 5/8" L x 14 1/4" W x 2 1/2" H
(47.3 x 36.2 x 6.4 cm)
- HMOV1621** 192 oz. (5.7 L)
20 1/8" L x 16 1/4" W x 3 1/2" H
(51.1 x 41.3 x 8.9 cm)

HMOST1520



HMOST1317

HMOST1115

HMOV1621



HMOV1418



Square Hammered Trays

| | |
|--------|------------------------------------|
| HMSQ12 | 12" Sq. x 1" H (30.5 x 2.5 cm) |
| HMSQ14 | 14" Sq. x 1" H (35.6 x 2.5 cm) |
| HMSQ16 | 16" Sq. x 1 1/8" H (40.6 x 2.9 cm) |
| HMSQ18 | 18" Sq. x 1 1/8" H (45.7 x 2.9 cm) |
| HMSQ20 | 20" Sq. x 1 1/8" H (50.8 x 2.9 cm) |
| HMSQ22 | 22" Sq. x 1 1/8" H (55.9 x 2.9 cm) |

Rectangular Hammered Trays

| | |
|----------|--|
| HMRT712 | 11 3/8" L x 7 3/8" W x 1" H (28.9 x 18.7 x 2.5 cm) |
| HMRT814 | 14 1/8" L x 7 5/8" W x 1" H (35.9 x 19.4 x 2.5 cm) |
| HMRT1019 | 18 5/8" L x 9 5/8" W x 1 3/8" H (47.3 x 24.4 x 3.5 cm) |
| HMRT1322 | 21 3/4" L x 12 3/4" W x 1 5/8" H (55.2 x 32.4 x 4.1 cm) |



Shown with TAGA6WT chalk cards, LK50 card holders, GMB8 glass milk bottles



From top to bottom:
HMRST1801
HMRST2001
HMRST2201



HMRST1401

HMRST1601



HMRST1301
shown
on SSUS1
riser

HMRT1611

HMRT247

Round Hammered Trays

- HMRST1401 14" Dia. x 1 1/8" H (35.6 x 2.9 cm)
- HMRST1601 16" Dia. x 1 1/8" H (40.6 x 2.9 cm)
- HMRST1801 18" Dia. x 1 1/8" H (45.7 x 2.9 cm)
- HMRST2001 20" Dia. x 1 1/8" H (50.8 x 2.9 cm)
- HMRST2201 22" Dia. x 1 1/8" H (55.9 x 2.9 cm)

Rectangular and Round Hammered Trays

- HMRT1611 Rectangular
16 5/8" L x 11 1/4" W x 3/8" H
(42.2 x 28.6 x 1 cm)
- HMRST1301 Round
78 oz. (2.3 L), 13 3/8" Dia. x 1 3/8" H
(34 x 3.5 cm)
- HMRT247 Rectangular
23 1/2" L x 7 1/2" W x 1/2" H
(59.7 x 19.1 x 1.3 cm)

USE THESE TO STAGE CLASSIC ENTRÉES OR AVANT-GARDE HORS D'OEUVRES; THESE PIECES FROM OUR HAMMERED COLLECTION RAISE CULINARY CREATIONS TO A HIGHER STANDARD OF ARTISTRY



Hammered Stainless Steel Serving Pans

- THRD17** Round
200 oz. (5.9 L)
15" Dia. x 2 3/8" H
17 5/8" Dia. x 3 7/8" H with Handles
(38.1 x 6, 44.8 x 9.8 cm)
- THOV19** Oval
168 oz. (5 L)
18 1/2" L x 12 3/4" W x 2" H
20 1/2" L x 3 1/2" H with Handles
(47 x 32.4 x 5.1, 52.1 x 8.9 cm)
- THRC21** Rectangular
168 oz. (5 L)
18 1/4" L x 14" W x 2" H
20 1/8" L x 3 1/4" H with Handles
(46.4 x 35.6 x 5.1, 51.1 x 8.3 cm)



Stainless Steel Square Bowls

Hammered

- SSQH53** 30 oz. (887.2 mL)
5" Sq. x 2 3/4" H (12.7 x 7 cm)
- SSQH73** 70 oz. (2.1 L)
7" Sq. x 3 1/4" H (17.8 x 8.3 cm)
- SSQH94** 146 oz. (4.3 L)
9 1/2" Sq. x 3 3/4" H (24.1 x 9.5 cm)
- SSQH117** 254 oz. (7.5 L)
12" Sq. x 4 1/2" H (30.5 x 11.4 cm)

Satin Finish

- SSQ53** 30 oz. (887.2 mL)
5" Sq. x 2 3/4" H (12.7 x 7 cm)
- SSQ73** 70 oz. (2.1 L)
7" Sq. x 3 1/4" H (17.8 x 8.3 cm)
- SSQ94** 146 oz. (4.3 L)
9 1/2" Sq. x 3 3/4" H (24.1 x 9.5 cm)
- SSQ117** 254 oz. (7.5 L)
12" Sq. x 4 1/2" H (30.5 x 11.4 cm)





DOUBLE-WALL BOWLS

Need to keep sauces, desserts and entrées cold? These stainless steel bowls get the job done and look fantastic in the process.

Hammered Double-Wall Bowls

- DWBH4** 17 oz. (502.8 mL)
4 ¾" Dia. x 2 ½" H (12.1 x 6.4 cm)
- DWBH6** 34 oz. (1 L)
6" Dia. x 3" H (15.2 x 7.6 cm)
- DWBH10** 156 oz. (4.6 L)
10" Dia. x 4" H (25.4 x 10.2 cm)
- DWBH12** 220 oz. (6.5 L)
12" Dia. x 5" H (30.5 x 12.7 cm)
- DWBH14** 338 oz. (10 L)
14" Dia. x 5" H (35.6 x 12.7 cm)
- DWBH16** 512 oz. (15.1 L)
16" Dia. x 5 ¾" H (40.6 x 14.6 cm)
- HMDWB14** 250 oz. (7.4 L)
14 ⅜" Dia. x 3 ¾" H (36.5 x 9.5 cm)
- HMDWB19** 657 oz. (19.4 L)
19" Dia. x 5 ½" H (48.3 x 14 cm)

Stackable Double-Wall Bowls

- SDWB40** 8 oz. (236.6 mL)
4" Dia. x 2" H (10.2 x 5.1 cm)
- SDWB45** 10 oz. (295.7 mL)
4 ½" Dia. x 2" H (11.4 x 5.1 cm)
- SDWB55** 16 oz. (473.2 mL)
5 ½" Dia. x 2" H (14 x 5.1 cm)



Satin Finish Double-Wall Bowls

- SW4** 17 oz. (502.8 mL)
4 ¾" Dia. x 2 ½" H (12.1 x 6.4 cm)
- DWB6** 34 oz. (1 L)
6" Dia. x 3" H (15.2 x 7.6 cm)
- DWB10** 156 oz. (4.6 L)
10" Dia. x 4" H (25.4 x 10.2 cm)
- DWB12** 220 oz. (6.5 L)
12" Dia. x 5" H (30.5 x 12.7 cm)
- DWB14** 338 oz. (10 L)
14" Dia. x 5" H (35.6 x 12.7 cm)
- DWB16** 512 oz. (15.1 L)
16" Dia. x 5 ¾" H (40.6 x 14.6 cm)

Angled Double-Wall Bowls

- AB6** 23 oz. (680.2 mL)
6" Dia. x 3 ½" H (15.2 x 8.9 cm)
- AB8** 54 oz. (1.6 L)
8" Dia. x 4 ⅝" H (20.3 x 11.7 cm)
- AB12** 108 oz. (3.2 L)
10" Dia. x 5" H (25.4 x 12.7 cm)
- AB13** 216 oz. (6.4 L)
12" Dia. x 6" H (30.5 x 15.2 cm)
- AB14** 304 oz. (9 L)
13 ⅞" Dia. x 6 ½" H (35.2 x 16.5 cm)



UNIQUELY GEOMETRIC
BOTTOM STYLING

Good



Aluminum Seafood Trays

- SEA10** 36 oz., 10" Dia. x 2 1/4" H
(1.1 L, 25.4 x 5.7 cm)
- SEA12** 75 oz., 12" Dia. x 2 1/4" H
(2.2 L, 30.5 x 5.7 cm)
- SEA14** 120 oz., 13 7/8" Dia. x 2 1/4" H
(3.5 L, 35.2 x 5.7 cm)
- SEA16** 160 oz., 16" Dia. x 2 1/4" H
(4.7 L, 40.6 x 5.7 cm)
- SEA18** 200 oz., 17 3/4" Dia. x 2 1/4" H
(5.9 L, 45.1 x 5.7 cm)
- SEA20** 250 oz., 19 3/4" Dia. x 2 1/4" H
(7.4 L, 50.2 x 5.7 cm)

Better



Stainless Steel Seafood Trays

- SSEA10** 36 oz., 10" Dia. x 2 1/4" H
(1.1 L, 25.4 x 5.7 cm)
- SSEA12** 118 oz., 12 1/2" Dia. x 2 1/4" H
(3.5 L, 31.8 x 5.7 cm)
- SSEA14** 169 oz., 14 5/8" Dia. x 2 1/4" H
(5 L, 37.1 x 5.7 cm)
- SSEA16** 230 oz., 16 3/8" Dia. x 2 1/4" H
(6.8 L, 41.6 x 5.7 cm)
- SSEA18** 287 oz., 17 3/4" Dia. x 2 1/4" H
(8.5 L, 45.1 x 5.7 cm)

Best



Double-Wall Stainless Steel Seafood Trays

- DWSEA10** 56 oz., 10" Dia. x 2 1/4" H
(1.7 L, 25.4 x 5.7 cm)
- DWSEA12** 80 oz., 12" Dia. x 2 1/4" H
(2.4 L, 30.5 x 5.7 cm)
- DWSEA14** 112 oz., 14" Dia. x 2 1/4" H
(3.3 L, 35.6 x 5.7 cm)
- DWSEA16** 160 oz., 15 1/2" Dia. x 2 1/4" H
(4.7 L, 39.4 x 5.7 cm)
- DWSEA18** 204 oz., 17 5/8" Dia. x 2 1/4" H
(6 L, 44.8 x 5.7 cm)

Best



Double-Wall Hammered Stainless Steel Seafood Trays

- DWHSEA10** 56 oz., 10" Dia. x 2 1/4" H
(1.7 L, 25.4 x 5.7 cm)
- DWHSEA12** 80 oz., 12" Dia. x 2 1/4" H
(2.4 L, 30.5 x 5.7 cm)
- DWHSEA14** 112 oz., 14" Dia. x 2 1/4" H
(3.3 L, 35.6 x 5.7 cm)
- DWHSEA16** 160 oz., 15 1/2" Dia. x 2 1/4" H
(4.7 L, 39.4 x 5.7 cm)
- DWHSEA18** 204 oz., 17 5/8" Dia. x 2 1/4" H
(6 L, 44.8 x 5.7 cm)



SSEA12 and SSEA16 trays shown with SDRCK



DWHSEA12 and DWHSEA18 shown with SDRCK seafood display rack

Single-Wall

Double-Wall



Copper Hammered Aluminum Seafood Trays

Single-Wall

ASEAC12 80 oz., 12" Dia. x 2" H
(2.4 L, 30.5 x 5.1 cm)

ASEAC14 128 oz., 14" Dia. x 2 1/2" H
(3.8 L, 35.6 x 6.4 cm)

Double-Wall

ADSEAC12 80 oz., 12" Dia. x 2 1/4" H
(2.4 L, 30.5 x 5.7 cm)

ADSEAC14 128 oz., 14" Dia. x 2 1/2" H
(3.8 L, 35.6 x 6.4 cm)



Silver Hammered Aluminum Seafood Trays

Single-Wall

ASEAS12 80 oz., 12" Dia. x 2" H
(2.4 L, 30.5 x 5.1 cm)

ASEAS14 128 oz., 14" Dia. x 2 1/2" H
(3.8 L, 35.6 x 6.4 cm)

Double-Wall

ADSEAS12 80 oz., 12" Dia. x 2 1/4" H
(2.4 L, 30.5 x 5.7 cm)

ADSEAS14 128 oz., 14" Dia. x 2 1/2" H
(3.8 L, 35.6 x 6.4 cm)



Black Hammered Aluminum Seafood Trays

Single-Wall

ASEAB12 80 oz., 12" Dia. x 2" H
(2.4 L, 30.5 x 5.1 cm)

ASEAB14 128 oz., 14" Dia. x 2 1/2" H
(3.8 L, 35.6 x 6.4 cm)

Double-Wall

ADSEAB12 80 oz., 12" Dia. x 2 1/4" H
(2.4 L, 30.5 x 5.7 cm)

ADSEAB14 128 oz., 14" Dia. x 2 1/2" H
(3.8 L, 35.6 x 6.4 cm)



Gold Hammered Aluminum Seafood Trays

Single-Wall

ASEAG12 80 oz., 12" Dia. x 2" H
(2.4 L, 30.5 x 5.1 cm)

ASEAG14 128 oz., 14" Dia. x 2 1/2" H
(3.8 L, 35.6 x 6.4 cm)

Double-Wall

ADSEAG12 80 oz., 12" Dia. x 2 1/4" H
(2.4 L, 30.5 x 5.7 cm)

ADSEAG14 128 oz., 14" Dia. x 2 1/2" H
(3.8 L, 35.6 x 6.4 cm)



ADSEAC12

ADSEAC14

Shown with SDRCK seafood display rack and MB1 sauce cup



ASEAB12

RUBBER COATING PREVENTS TRAYS FROM SLIDING

ASEAB1

Shown with RSRB stand, ASPB sauce cup, WVAT1 tongs and DPN9WH plates

NEW

MSEA10G and
MSEA12G shown
with RSRW8



NEW

Melamine Seafood Trays

NEW BPA FREE

Stylish seafood setups are a breeze with a perfect combination of durable melamine trays, non-slip rubberized stands and perforated ice screens. Available in multiple colors to coordinate with every tabletop.

Silver

MSEA10S 67 oz., 10" Dia. x 2 1/4" H
(2 L, 25.4 x 5.7 cm)

MSEA12S 110 oz., 13" Dia. x 2 1/4" H
(3.3 L, 33 x 5.7 cm)

NEW

Black

MSEA10B 67 oz., 10" Dia. x 2 1/4" H
(2 L, 25.4 x 5.7 cm)

MSEA12B 110 oz., 13" Dia. x 2 1/4" H
(3.3 L, 33 x 5.7 cm)

NEW

Gold

MSEA10G 67 oz., 10" Dia. x 2 1/4" H
(2 L, 25.4 x 5.7 cm)

MSEA12G 110 oz., 13" Dia. x 2 1/4" H
(3.3 L, 33 x 5.7 cm)



DURABLE MELAMINE DRIP TRAYS ADD AESTHETIC AND CONVENIENCE TO SEAFOOD PRESENTATION



Melamine Seafood Drip Trays NEW BPA FREE

Black

MDT9B 9 3/8" Dia. x 5/8" H
(23.8 x 1.6 cm)

MDT12B 12 3/8" Dia. x 5/8" H
(31.4 x 1.6 cm)

White

MDT9W 9 3/8" Dia. x 5/8" H
(23.8 x 1.6 cm)

MDT12W 12 3/8" Dia. x 5/8" H
(31.4 x 1.6 cm)

Rubberized Seafood Stands NEW WATER RESISTANT NON-SLIP

RSRW8 White
8 3/4" Top Dia. x 12" Bottom Dia. x 6 3/8" H
(22.2 x 30.5 x 16.2 cm)

RSRB8 Black
8 3/4" Top Dia. x 12" Bottom Dia. x 6 3/8" H
(22.2 x 30.5 x 16.2 cm)



NEW

DWHVSEA14 and DWHVSEA18 shown with SDRCKV7



NEW

Oval Double-Wall Hammered Stainless Steel Seafood Trays NEW

Give everyone at the table a chance to dig into that delicious seafood display using our oval double-wall seafood trays. Made of hand-hammered stainless steel and double-walled for extra insulation, seafood towers have never looked so good. Longer, oblong shape allows for easy access on the table.

DWHVSEA14 81 oz., 14" L x 9" W x 2 1/4" H (2.4 L, 35.6 x 22.9 x 5.7 cm)

DWHVSEA18 139 oz., 18" L x 12" W x 2 1/4" H (4.1 L, 45.7 x 30.5 x 5.7 cm)

Oblong Seafood Display Racks NEW

Now oblong trays and bowls get a lift with these dynamic oval display racks - the perfect way to ensure everyone at the table can grab a bite.

SDRCKV4 10" L x 5" W Top x 12" L x 7" W Bottom x 4" H (25.4 x 12.7 x 30.5 x 17.8 x 10.2 cm)

SDRCKV7 10" L x 5" W Top x 12" L x 7" W Bottom x 7 3/8" H (25.4 x 12.7 x 30.5 x 17.8 x 18.7 cm)

NEW



SDRCKV7





SDRCKV4



Contempo™ Swirl Risers

The contemporary swirls of these risers are sure to elevate your cuisine in more ways than one. Wire is $\frac{3}{8}$ " thick

LWUS779  7 $\frac{1}{8}$ " Top Dia. x 9" Bottom Dia. x 7" H
(18.1 x 22.9 x 17.8 cm)

LWUSR  7" Top Dia. x 9" Bottom Dia. x 6 $\frac{3}{8}$ " H
(17.8 x 22.9 x 16.2 cm)

SSUS1 7 $\frac{1}{4}$ " Top Dia. x 9" Bottom Dia. x 6 $\frac{3}{4}$ " H
(18.4 x 22.9 x 17.1 cm)

Seafood Display Racks

SDRCK4 Small
7 $\frac{1}{2}$ " Top Dia. x 9 $\frac{5}{8}$ " Bottom Dia. x 4" H
(19.1 x 24.4 x 10.2 cm)

SDRCK Large
7 $\frac{1}{2}$ " Top Dia. x 9 $\frac{5}{8}$ " Bottom Dia. x 7 $\frac{3}{8}$ " H
(19.1 x 24.4 x 18.7 cm)





RSRBH7

RSRBH4

RUBBERIZED COATING KEEPS
BOWLS AND PANS IN PLACE



RSR10

RSRB4

RSRB

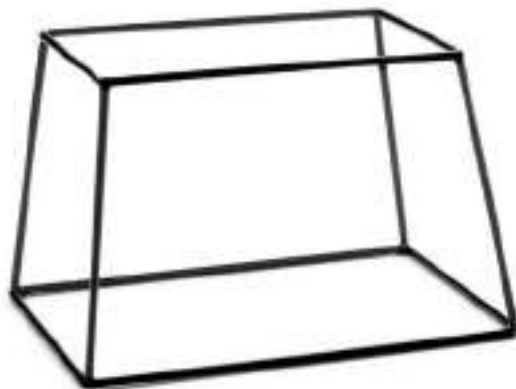

RSRB7



RSRB3

Loft Collection Rubberized Hairpin Stands

The newest additions to our black rubberized stands, these risers boast unique hairpin curved legs with an added rubberized texture to keep things in place.

RSRBH4 9" Dia. x 4" H (22.9 x 10.2 cm)

RSRBH7 9" Dia. x 7" H (22.9 x 17.8 cm)

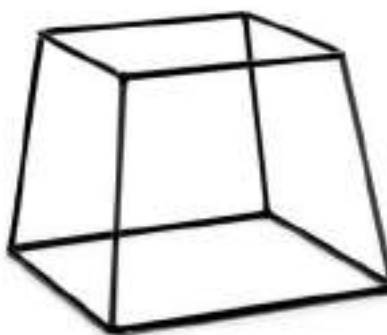

RSSB7

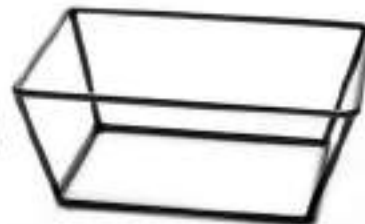

RSSB3

Black Rubberized Stands

Tired of tracking down rubber stoppers to keep your pizza pans in place? These ingenious stands have the rubber built in. Plus, each of these contemporary wire-frame designs are reversible.

Round

RSRB4 7 1/2" Dia. Top x 9 5/8" Bottom Dia. x 4" H (19.1 x 24.4 x 10.2 cm)

RSRB 7 1/2" Dia. Top x 9 5/8" Bottom Dia. x 7 3/8" H (19.1 x 24.4 x 18.7 cm)

RSR10 8 3/8" Dia. Top x 9 7/8" Bottom Dia. x 11 3/4" H (21.3 x 25.1 x 29.8 cm)

Rectangular

RSRB3 9" L x 6" W Top x 11" L x 8" W Bottom x 3 1/2" H (22.9 x 15.2 x 27.9 x 20.3 x 8.9 cm)

RSRB7 9" L x 6" W Top x 11" L x 8" W Bottom x 7" H (22.9 x 15.2 x 27.9 x 20.3 x 17.8 cm)

Square

RSSB3 7" Sq. Top x 9" Sq. Bottom x 3 1/2" H (17.8 x 22.9 x 8.9 cm)

RSSB7 7" Sq. Top x 9" Sq. Bottom x 7" H (17.8 x 22.9 x 17.8 cm)

Rubberized Wedges

Level up your display - literally - with these handy rubberized wedges! The rubberized coating allows you to prop up crates and trays for full display. Available in different heights for different needs.

DWRB2 5" L x 3" W x 2 1/2" H (12.7 x 7.6 x 6.4 cm)

DWRB5 5" L x 5" W x 5" H (12.7 x 12.7 x 12.7 cm)



DWRB5

DWRB2

NEW

USE TO PROP UP MARKET TRAYS ON PG. 176-177



AS20 shown with
MEL23 platter

AS20 shown with
MEL12 platter

AS20 shown with
MEL19 platter and
RGJ4 jars

Shown with HAMSC4, BS31, B31, BH31 sauce cups and KKNF7 cheese knife

LENGTH, WIDTH AND HEIGHT ARE FULLY ADJUSTABLE



Stainless Steel Adjustable Riser

A versatile addition to any buffet setup, this stainless steel stand can fit just about any rectangular platter. Its length, width and height can all be adjusted, making it our most adaptable riser to date.

AS20 12 ¼" L x 7 ⅛" W x 2 ⅞" H
(31.1 x 18.1 x 7.3 cm)
Expands up to 21" L x 11 ½" x 4 ⅛" H
(53.3 x 29.2 x 10.5 cm)

Three-Tier Chrome Arch Stands

An innovative step ladder design makes these stands collapsible when not in use. Check out pg. 455 to see which of our products provide a perfect fit.

TASSM 17 ½" L x 6" W x 11 ¼" H
(44.5 x 15.2 x 28.6 cm)

TASMED 25 ¼" L x 10 ½" W x 13 ¾" H
(64.1 x 26.7 x 34.9 cm)

TASLG 21" L x 15 ¼" W x 12 ¾" H
(53.3 x 38.7 x 32.4 cm)

TASMED shown with CRGSQ94,
TWBB94 and FSMEL94 bowls

TASLG shown with
MEL19 and BAM14
platters

TASSM shown with
GJ24 glass jars

IRONWORKS™ WROUGHT IRON STANDS

Available in two- and three-tier designs, these elegant wrought iron stands hold a wide range of trays, bowls, platters and baskets. Refer to pg. 454 for suggestions on the most effective product combinations. Assembly required.

Rectangular Stands

IS13* Three-Tier Stand
 24 1/2" L x 12 9/16" W x 32 3/8" H
 (62.2 x 31.9 x 82.2 cm)

*Indicates oversize package for UPS

Two-Tier Ironworks Stand

TLSP1219 19 3/8" L x 11 3/4" W x 12 3/8" H
 (49.2 x 29.8 x 31.4 cm)

IS13 shown with three
 MWME121 platters



TLSP1219

Shown with GBB20 and
 GBB15 glacier bowls



TTREC3 shown with three MEL19 platters

Three-Tier Foldable Stands

Elevate your presentations with our three-tier risers.

Rectangular

TTREC3 Open Frame Foldable Stand
17 3/8" L x 7 1/2" W x 10" H
(44.1 x 19.1 x 25.4 cm)

TPREC3 Solid Frame Foldable Stand
 17 3/8" L x 7 1/2" W x 10" H
(44.1 x 19.1 x 25.4 cm)

TMEL3 (1) TTREC3 Open Frame Foldable Stand with
 (3) MEL19 Melamine Platters

Round

TTRS3 Open Frame Foldable Stand
14 1/8" W x 17 3/8" H
(35.9 x 44.1 cm)

TTRSMEL7 (1) TTRS Open Frame Foldable Stand
 with (3) MEL7 Melamine Bowls

Three-Tier Rectangular Stands

IS18 Open Frame Stand
20" L x 13 3/4" W x 12" H
(50.8 x 34.9 x 30.5 cm)

ISP18 Solid Frame Stand
 20" L x 13 3/4" W x 12" H
(50.8 x 34.9 x 30.5 cm)



TPREC3

RECTANGULAR THREE-TIER STANDS ARE AVAILABLE IN ATTRACTIVE RETAIL PACKAGING



TPREC3

ISP18





BRT3 shown with MW18,
MW24 and MW32 platters

Black Twilight Collection Modular Risers

NEW  

Building a customized buffet display has never been easier with our Black Twilight Collection Modular Risers. Designed to adapt to your changing menu needs, each riser can expand a display taller, wider or longer to serve anything from a small luncheon to a large dinner party. Further personalize your look with complementary platters available in different lengths and finishes. Finally, accessorize your display with additional items from the Black Twilight Collection to provide the finishing touches.

- BRT1** Single-Tier Riser
10" L x 10" W x 7 5/8" H
(25.4 x 25.4 x 19.4 cm)
- BRT2** Two-Tier Riser
10" L x 10" W x 16 1/2" H
(25.4 x 25.4 x 41.9 cm)
- BRT3** Three-Tier Riser
10" L x 10" W x 25 1/2" H
(25.4 x 25.4 x 64.8 cm)

NEW



Serving Platters NEW

White Marble Melamine

MW18 17 3/4" L x 8 3/4" W x 5/8" H
(45.1 x 22.2 x 1.6 cm)

MW24 24" L x 8 3/4" W x 5/8" H
(61 x 22.2 x 1.6 cm)

MW32 31 1/2" L x 8 3/4" W x 5/8" H
(80 x 22.2 x 1.6 cm)

Espresso Wood

MWP18 17 3/4" L x 8 3/4" W x 7/8" H
(45.1 x 22.2 x 2.2 cm)

MWP24 24" L x 8 3/4" W x 7/8" H
(61 x 22.2 x 2.2 cm)

MWP32 32" L x 8 3/4" W x 7/8" H
(81.3 x 22.2 x 2.2 cm)

Acacia Wood

AB189 17 3/4" L x 8 3/4" W x 3/4" H
(45.1 x 22.2 x 1.9 cm)

AB249 24" L x 8 3/4" W x 3/4" H
(61 x 22.2 x 1.9 cm)

AB329 32" L x 8 3/4" W x 3/4" H
(81.3 x 22.2 x 1.9 cm)

NEW



BRT1 and BRT2 shown with MWP18 and MWP32 platters



BRR9 shown with **BR15** multifunctional riser and (2) **MTB156** trays

BRR6 shown with **BR15** multifunctional riser



BRR9 shown with **BR15** multifunctional riser and (3) **GJ40** jars

BRR6 shown with **BR15** multifunctional riser and (3) **GJ40** jars



BRR9 shown with (3) **GJ40** jars

BRR6 shown with (3) **GJ40** jars

BUILT IN TILTING DESIGN



CAN BE USED WITH **MSJ5** JARS

Black Twilight Merchandising Risers

Build a full-service grab-and-go station or neatly organize condiments, snacks, and other buffet goodies. The possibilities are endless with these versatile and modern black metal risers. Complete the setup with our assortment of jars, baskets, and market trays.

BRR6 15" L x 5 1/2" W x 6" H
(38.1 x 14 x 15.2 cm)

BRR9 15" L x 5 1/2" W x 9" H
(38.1 x 14 x 22.9 cm)

Merchandising Riser Accessories

MSJ5 Melamine Square Jar
44 oz. (1.3 L)
4 7/8" Sq. x 5" H (12.4 x 12.7 cm)

GJ40 Square Glass Jar
40 oz. (1.2 L)
4 3/4" Sq. x 4 7/8" H (12.1 x 12.4 cm)

BR15 Black Twilight Multifunctional Riser
14 3/8" L x 5 1/8" W x 2" H
(37.1 x 13 x 5.1 cm)

MTB156 Black Twilight Market Tray
15" L x 6" W x 2" H
(38.1 x 15.2 x 5.1 cm)

MTB1512 Black Twilight Market Tray
15" L x 12" W x 2" H
(38.1 x 30.5 x 5.1 cm)
(not shown)

BR15 shown with GJ40 square glass jars



BR126 shown with
MWML19 platter

Shown with BLHT1 tongs and CP7CL coupe plates

BR128

Black Twilight Multifunctional Risers

Whichever way you use them, these metal risers would be a stylish, uber-versatile addition to your buffet service roster. Check out pg. 456 for accessory fit options.

BR126 12 1/8" L x 6 1/8" W x 2" H
(30.8 x 15.6 x 5.1 cm)

BR15 14 5/8" L x 5 1/8" W x 2" H
(37.1 x 13 x 5.1 cm)

BR128 12 1/8" L x 8 1/8" W x 2" H
(30.8 x 20.6 x 5.1 cm)

Black Twilight Two-Tiered Condiment Rack

Contemporary and sleek, this jet-black condiment organizer is an elegant way to keep toppings, sauces or straws in order. Check out pg. 456 for accessory fit options.

BTS2 12 3/4" L x 9" W x 6" H
(32.4 x 22.9 x 15.2 cm)



BTS2 shown with
GJ24 square glass jars,
MESABUSH13 coffee urn

Black Twilight Angled Risers

These black iron risers are modernizing buffetware design at full tilt. The unique angled construction makes self-service easier and looks striking in the process.

ARB3 Set of 3
6 1/2" Sq. x 5 3/4" H
(16.5 x 14.6 cm)
8 1/2" Sq. x 5 3/4" H
(21.6 x 14.6 cm)
10" Sq. x 5 3/4" H
(25.4 x 14.6 cm)



ARB3 shown with
MWMSQ7, MWMSQ9 and
MWMSQ11 bowls

Black Twilight Napkin Holder

Conveniently and compactly display napkins, guest towels and more with this sleek black napkin holder. Versatile enough to fit most decors but complements the Black Twilight Collection completely.

NCB95 9" L x 5" W x 4 1/2" H
(22.9 x 12.7 x 11.4 cm)



NCB95



TTS2319 shown with
PORD39 porcelain
sauce cup



Stainless Steel Tier Stands

The most graceful afternoon teas and pastry parties warrant the most graceful stages. These two- and three-tier stands impress customers in any setting.

STS2 Two-Tier Stand
5 1/2" Dia. x 6 3/8" H
(14 x 16.8 cm)

STS3 Three-Tier Stand
8 1/2" Dia. x 13" H
(21.6 x 33 cm)

Ascent³ Three-Tier Stand

In hammered stainless steel, this three-tier stand is the ultimate in elegance.

TTS2319 23" Dia. x 19 3/4" H
(58.4 x 50.2 cm)

Curl Riser Sets

Choose from a satin or hammered finish to complete these uniquely contemporary stainless steel risers.

Satin

CRS3 Set of 3
8 1/4" L x 4" W x 2" H
(21 x 10.2 x 5.1 cm)
10 1/2" L x 5 1/4" W x 4" H
(26.7 x 13.3 x 10.2 cm)
12 1/2" L x 6" W x 6 1/2" H
(31.8 x 15.2 x 16.5 cm)

Hammered

CRH3 Set of 3
8 1/4" L x 4" W x 2" H
(21 x 10.2 x 5.1 cm)
10 1/2" L x 5 1/4" W x 4" H
(26.7 x 13.3 x 10.2 cm)
12 1/2" L x 6" W x 6 1/2" H
(31.8 x 15.2 x 16.5 cm)



CRS3 shown with
FSLT14 platter



CRH3 shown with
GBG19 bowl

Shown with DPN9WH
narrow rim plates
and GVHT1 tongs



Tiered Buffet Stands

Give your next buffet a huge wow factor with these stunning stands. In colors and shapes designed to impress, there's no better way to elevate bite-sized hors d'oeuvres and desserts to the level of luxury. Built-in plates are crafted from frosted glass.

Gold

SRG3 Oval, Three-Tier Stand
12" L x 7" W x 20 1/2" H
(30.5 x 17.8 x 52.1 cm)
6" and 7 1/4" Dia. Glass Plates
(15.2 and 18.4 cm)

SRG4 Round, Four-Tier Stand
21 1/8" L x 6 5/8" W x 21 3/4" H
(53.7 x 16.8 x 55.2 cm)
6" and 7 1/4" Dia. Glass Plates
(15.2 and 18.4 cm)

Silver

SRS3 Oval, Three-Tier Stand
12" L x 7" W x 20 1/2" H
(30.5 x 17.8 x 52.1 cm)
6" and 7 1/4" Dia. Glass Plates
(15.2 and 18.4 cm)

SRS4 Round, Four-Tier Stand
21 1/8" L x 6 5/8" W x 21 3/4" H
(53.7 x 16.8 x 55.2 cm)
6" and 7 1/4" Dia. Glass Plates
(15.2 and 18.4 cm)

Replacement Frosted Glass Plates

RG6 6" Dia. (15.2 cm)

RG7 7 1/4" Dia. (18.4 cm)

Shown with DPW6WH
wide rim plates and
WVAT1 tongs





RRG2

Geo Riser Sets

With a sleek satin finish and minimalist design, these shimmering gold and black risers are always en vogue. Available in square and round shapes.

Gold

RRG2 Round, Set of 3
 5" Dia. x 1 1/2" H (12.7 x 3.8 cm)
 7" Dia. x 3" H (17.8 x 7.6 cm)
 9" Dia. x 5" H (22.9 x 12.7 cm)

RSQG2 Square, Set of 3
 5" Sq. x 1 1/2" H (12.7 x 3.8 cm)
 7" Sq. x 3" H (17.8 x 7.6 cm)
 9" Sq. x 5" H (22.9 x 12.7 cm)

Black

RRB2 Round, Set of 3
 5" Dia. x 1 1/2" H (12.7 x 3.8 cm)
 7" Dia. x 3" H (17.8 x 7.6 cm)
 9" Dia. x 5" H (22.9 x 12.7 cm)

RSQB2 Square, Set of 3
 5" Sq. x 1 1/2" H (12.7 x 3.8 cm)
 7" Sq. x 3" H (17.8 x 7.6 cm)
 9" Sq. x 5" H (22.9 x 12.7 cm)



RSQG2



RRB2



RSQB2

Shown LFTPBI2 and LFTPWI2 plates



Geometric Riser Sets

Rise to the occasion with our Geometric Risers available in multiple color options and popular heights. Combining lines, angles and shapes together in a cohesive design, these risers are versatile enough to be used with bowls, platters and serving boards.

Gold

- RSGG3** Set of 3
 6" Dia. x 6" H
 (15.2 x 15.2 cm)
 7" Dia. x 7" H
 (17.8 x 17.8 cm)
 9" Dia. x 9" H
 (22.9 x 22.9 cm)

Black

- RRGB3** Set of 3
 6" Dia. x 6" H
 (15.2 x 15.2 cm)
 7" Dia. x 7" H
 (17.8 x 17.8 cm)
 9" Dia. x 9" H
 (22.9 x 22.9 cm)

Stainless Steel

- RSGS3** Set of 3
 6" Dia. x 6" H
 (15.2 x 15.2 cm)
 7" Dia. x 7" H
 (17.8 x 17.8 cm)
 9" Dia. x 9" H
 (22.9 x 22.9 cm)

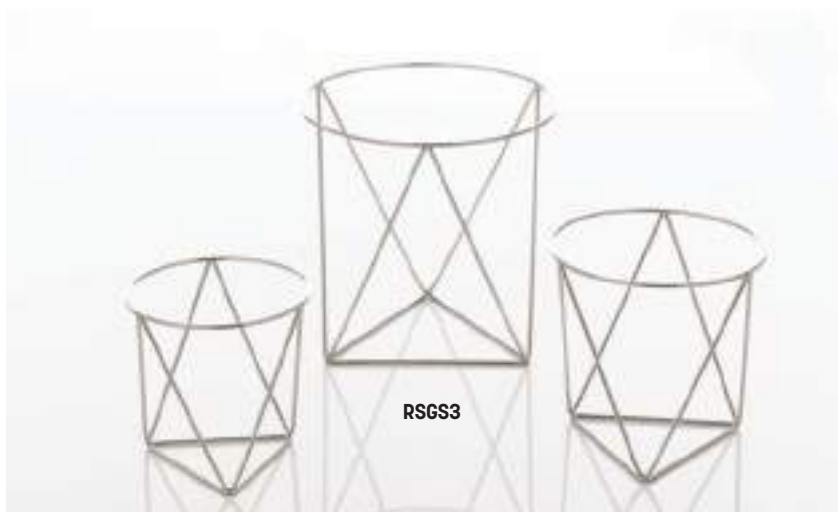



RSG3

Gold Riser Sets

Our customers asked, and we answered. These gold risers are guaranteed crowd-pleasers. In your choice of satin finish or hammered gold.

Satin Finish

- RSG3** Set of 3
 6" Sq. x 4" H (15.2 x 10.2 cm)
 7" Sq. x 6" H (17.8 x 15.2 cm)
 8" Sq. x 8" H (20.3 x 20.3 cm)

Hammered

- RHG1** Set of 3
 6" Sq. x 4" H (15.2 x 10.2 cm)
 7" Sq. x 6" H (17.8 x 15.2 cm)
 8" Sq. x 8" H (20.3 x 20.3 cm)

Stainless Steel Riser Sets

Individually hammered with a ball-peen hammer or in brushed satin, each riser in these sets is unique. Designed to nest for efficient storage.

Satin Finish

- RSS3** Set of 3
 6" Sq. x 4" H (15.2 x 10.2 cm)
 7" Sq. x 6" H (17.8 x 15.2 cm)
 8" Sq. x 8" H (20.3 x 20.3 cm)

Hammered

- RSH1** Set of 3
 6" Sq. x 4" H (15.2 x 10.2 cm)
 7" Sq. x 6" H (17.8 x 15.2 cm)
 8" Sq. x 8" H (20.3 x 20.3 cm)



RHG1



RSS3 shown with BG189 platter



RSH1 shown with MEL23 platter



AC579 shown with GBB15 bowl

Acrylic Frosted Cube Riser Set

These modern, versatile risers are a brilliant addition to all manner of tablescapes.

- AC579** Set of 3
 5" Sq. (12.7 cm)
 7" Sq. (17.8 cm)
 9" Sq. (22.9 cm)

Acrylic Riser Sets

Simple, subtle and versatile, these risers come in sets of four in black or clear acrylic.

Clear

- CRS1** Set of 4
 5" Sq. x 2" H (12.7 x 5.1 cm)
 6" Sq. x 4" H (15.3 x 10.2 cm)
 7" Sq. x 6" H (17.8 x 15.3 cm)
 8" Sq. x 8" H (20.3 x 20.3 cm)

Black

- BRS2** Set of 4
 5" Sq. x 2" H (12.7 x 5.1 cm)
 6" Sq. x 4" H (15.3 x 10.2 cm)
 7" Sq. x 6" H (17.8 x 15.3 cm)
 8" Sq. x 8" H (20.3 x 20.3 cm)



CRS1



BRS2



HMRSET shown with BG1911 platter and SRCH4 card holder

Hammered Stainless Steel Frame Riser Sets

These three-piece riser sets are a stylish way to elevate higher-end culinary creations.

Solid Frame

HMPRS3 Square, Set of 3
 6 ¾" Sq. x 3" H (17.1 x 7.6 cm)
 7 ¾" Sq. x 4" H (19.7 x 10.2 cm)
 9 ¼" Sq. x 5" H (23.5 x 12.7 cm)

HMPRR3 Rectangle, Set of 3
 12 ¾" L x 6" W x 3 ⅞" H
 (32.4 x 15.2 x 7.9 cm)
 13 ¾" L x 7 ⅞" W x 4 ⅞" H
 (34.9 x 18.1 x 10.5 cm)
 14 ½" L x 8 ¼" W x 5 ⅞" H
 (36.8 x 21 x 13 cm)

Open Frame

HMRSET Rectangle, Set of 3
 7 ½" L x 4 ½" W x 4 ¾" H
 (19.1 x 11.4 x 12.1 cm)
 9 ¼" L x 6" W x 6 ½" H
 (23.5 x 15.2 x 16.5 cm)
 11 ½" L x 7 ⅞" W x 7 ½" H
 (29.2 x 20 x 19.1 cm)

Cube Stainless Steel Risers

These brushed stainless steel risers create an upscale, contemporary look that complements even the sleekest settings.

SSR8 4" Sq. x 8" H (10.2 x 20.3 cm)
SSR12 4" Sq. x 12" H (10.2 x 30.5 cm)
SSR4 8" Sq. x 4" H (20.3 x 10.2 cm)



SSR12 shown with BG189 platter



Wood Frame Riser Sets

Black laquered wood in an open or solid frame works well in any buffet or banquet setting.

Solid Frame

AWRSP Square, Set of 3
 6 ³/₄" Sq. x 3" H
 (17.1 x 7.6 cm)
 8 ¹/₂" Sq. x 4 ¹/₂" H
 (21.6 x 11.4 cm)
 10 ¹/₄" Sq. x 6" H
 (26 x 15.2 cm)

AWRRP Rectangle, Set of 3
 13" L x 5 ³/₄" W x 3" H
 (33 x 14.6 x 7.6 cm)
 14 ¹/₂" L x 7" W x 4 ¹/₂" H
 (36.8 x 17.8 x 11.4 cm)
 16" L x 8" W x 6" H
 (40.6 x 20.3 x 15.2 cm)

AWRS Rectangle, Set of 3
 13 ³/₄" L x 7 ³/₈" W x 3 ³/₈" H
 (34.9 x 18.7 x 8.6 cm)
 17 ¹/₂" L x 8 ¹/₂" W x 6 ¹/₂" H
 (44.5 x 21.6 x 16.5 cm)
 20 ³/₈" L x 11 ¹/₄" W x 9 ³/₈" H
 (51.8 x 28.6 x 23.8 cm)

Open Frame

AWR10 Rectangle, Set of 3
 13 ³/₄" L x 7 ³/₈" W x 3 ³/₈" H
 (34.9 x 18.7 x 8.6 cm)
 17 ¹/₂" L x 8 ¹/₂" W x 6 ¹/₂" H
 (44.5 x 21.6 x 16.5 cm)
 20 ³/₈" L x 11 ¹/₄" W x 9 ³/₈" H
 (51.8 x 28.6 x 23.8 cm)



AWR10
 shown with
 CRGT23 and
 CRGT21
 platters



NESTS FOR EASY, ELEGANT STORAGE



RSB1 shown with CRGSQ53 and CRGSQ94 square bowls



RSM2 shown with AWMEL19 and AWMEL23 platters

Wood Riser Sets

These geometric pieces inspire all sorts of imaginative uses. Choose from black or mahogany and create a canvas for glass, melamine, ceramic or even metal dishes.

Black

- RSB1** Set of 3
- 5" Sq. (12.7 cm)
- 7" Sq. (17.8 cm)
- 9" Sq. (22.9 cm)

Mahogany

- RSM2** Set of 3
- 5" Sq. (12.7 cm)
- 7" Sq. (17.8 cm)
- 9" Sq. (22.9 cm)



THICK ACRYLIC WALLS STAND UP TO SUBSTANTIAL WEIGHT

Glacier Acrylic Risers

These acrylic risers look as though they've been chiseled from ice, creating an elegant stage for sushi, hors d'oeuvres and other light bites.

- AC555** 5" Sq. (12.7 cm)
- AC777** 7" Sq. (17.8 cm)

NEW



MWR3 shown with MW24 platter, GVHT6 tongs, GCHG3 card holder and TAGA7WT chalk card

Upton Collection

Arch Riser Sets NEW

The arch. The symbol of strength and stability. The perfect shape for an elegant riser collection from American Metalcraft. Available in a set of three different sizes and heights, these espresso-finished wood risers can mix and match with other wood boards for a complete look. Even flip them upside down for an entirely different aesthetic.

- MWR3** Set of 3
 8 1/2" L x 5" W x 4 3/8" H
 (21.6 x 12.7 x 11.7 cm)
 10 3/8" L x 5" W x 6 3/8" H
 (26.4 x 12.7 x 16.2 cm)
 12" L x 5" W x 8" H
 (30.5 x 12.7 x 20.3 cm)



Upton Collection Crates NEW

These wood crates are as versatile as it gets. As their name implies, use them for holding and storage. They're also a perfect way to display your most delectable baked goods, or you can turn them over to give your buffet a lift. Pair with compatible roll-top polycarbonate lids to keep foods fresh.

- MW1210** Half-Size
 12 3/8" L x 10 1/4" W x 2 1/2" H
 (31.4 x 26 x 6.4 cm)
- MW2012** Full-Size
 20 3/4" L x 12 5/8" W x 2 1/2" H
 (52.7 x 32.1 x 6.4 cm)



Shown with GVHT1 tongs, GCHG3 card holder, TAGA7WT chalk card and ARP6WH plates

CAN BE USED WITH ROLL-TOP POLYCARBONATE LIDS (PG. 220)





RBR33 shown with PSPL12 porcelain plate and OWBG9 serving board

Round Bamboo Riser Set

Form and function combine with this set. Use them as risers with bowls.

- RBR33** Set of 3
 6" Dia. x 4" H
 (15.2 x 10.2 cm)
 9" Dia. x 5" H
 (22.9 x 12.7 cm)
 11" Dia. x 6" H
 (27.9 x 15.2 cm)

Bamboo Frame Riser Set

Minimalist form and natural wood color lend a whimsical, organic atmosphere to buffets. Can be used vertically or horizontally for different heights.

- BAMRSET** Set of 3
 7 1/2" L x 4 1/4" W x 4 3/4" H
 (19.1 x 10.8 x 12.1 cm)
 9 1/4" L x 6 1/4" W x 6" H
 (23.5 x 15.9 x 15.2 cm)
 11 1/4" L x 7 1/2" W x 7 7/8" H
 (28.6 x 19.1 x 20 cm)



BAMRSET shown with BD35 balti dishes on HMRT1019 and HMRT814 trays

Bamboo Riser Sets

Some of our most popular risers, these versatile pieces inspire warmth in any setting.

Natural

- BAMRN1** Set of 3
 5" Sq. x 2 1/2" H
 (12.7 x 6.4 cm)
 7" Sq. x 4 3/4" H
 (17.8 x 12.1 cm)
 9" Sq. x 6 3/8" H
 (22.9 x 16.2 cm)

Dark

- BAMRD2** Set of 3
 5" Sq. x 2 1/2" H
 (12.7 x 6.4 cm)
 7" Sq. x 4 3/4" H
 (17.8 x 12.1 cm)
 9" Sq. x 6 3/8" H
 (22.9 x 16.2 cm)



BAMRN1 shown with CER9 and SQB88 bowls



BAMRD2 shown with BG159 and BG189 platters



WOOD CRATES AND CADDIES

In multiple sizes and finishes, our line of wood crates and caddies works hard in any setting. Smaller sizes are a tasteful way to hold condiments, napkins or flatware, while larger crates are sized to fit with polycarbonate and insulated inserts. Best of all, every piece in this line can be flipped over and used as an imaginative riser. Ideal for display only. Not for transport.

Bamboo Wood Crates and Caddies

Crates

- WTBA6** 1/6-Size
6 1/4" L x 5 3/4" W x 5 3/4" H
(15.9 x 14.6 x 14.6 cm)
- WTBA12** 1/3-Size
12 1/4" L x 6 1/4" W x 6" H
(31.1 x 15.9 x 15.2 cm)
- WTBA10** Half-Size
10 1/4" L x 12 1/2" W x 8" H
(26 x 31.8 x 20.3 cm)
- WTBA20** Full-Size
20 1/2" L x 12 1/2" W x 8" H
(52.1 x 31.8 x 20.3 cm)

Beverage Inserts

- IBT65** 1/6-Size Insulated Insert for WTBA6 (not shown)
- IBT126** 1/3-Size Insulated Insert for WTBA12 (not shown)
- IBT200** Full-Size Polycarbonate Insert for WTBA20 (not shown)

Caddies

- WCBA4** 3 7/8" Sq. x 4 3/4" H
(9.8 x 12.1 cm)
- WCBA7** 7 1/2" L x 6 1/4" W x 4 3/4" H
(19.1 x 15.9 x 12.1 cm)



Shown with **TASSM** stand, **BEE316** shaker and **TIMI** waste bin



WARNING: This product can expose you to chemicals including Bisphenol A (BPA), which is known to the State of California to cause birth defects or other reproductive harm. For more information, go to www.P65warnings.ca.gov. Warning applies to State of California only.



WTV10

WTV12

WTV20 shown with
IBT200 polycarbonate insert

WTV6



WCVL

WCVS



WCV4

WCV7

CADDIES FIT NEATLY IN
LARGER RECTANGULAR
CONDIMENT RACKS LIKE
OUR BWC12 ON PG. 109

Vintage Wood Crates and Caddies

Crates

- WTV6** 1/6-Size
6 1/4" L x 5 3/4" W x 5 3/4" H
(15.9 x 14.6 x 14.6 cm)
- WTV12** 1/3-Size
12 1/4" L x 6 1/4" W x 6" H
(31.1 x 15.9 x 15.2 cm)
- WTV10** Half-Size
10 1/4" L x 12 1/2" W x 8" H
(26 x 31.8 x 20.3 cm)
- WTV20** Full-Size
20 1/2" L x 12 1/2" W x 8" H
(52.1 x 31.8 x 20.3 cm)
- WCVL** 17 3/8" L x 9 1/8" W x 2 3/8" H
(44.1 x 23.2 x 6 cm)
- WCVS** 9" Sq. x 2 3/8" H
(22.9 x 6 cm)

Beverage Inserts

- IBT65** 1/6-Size Insulated
Insert for WTV6
- IBT126** 1/3-Size Insulated
Insert for WTV12
- IBT200** Full-Size Polycarbonate
Insert for WTV20

Caddies

- WCV4** 3 7/8" Sq. x 4 3/4" H
(9.8 x 12.1 cm)
- WCV7** 7 1/2" L x 6 1/4" W x 4 3/4" H
(19.1 x 15.9 x 12.1 cm)



WARNING: This product can expose you to chemicals including Bisphenol A (BPA), which is known to the State of California to cause birth defects or other reproductive harm. For more information, go to www.P65warnings.ca.gov. Warning applies to State of California only.

Black Wood Crates and Caddies

Crates

- WTBL6** 1/6-Size
6 1/4" L x 5 3/4" W x 5 3/4" H
(15.9 x 14.6 x 14.6 cm)
- WTBL12** 1/3-Size
12 1/4" L x 6 1/4" W x 6" H
(31.1 x 15.9 x 15.2 cm)
- WTBL10** Half-Size
10 1/4" L x 12 1/2" W x 8" H
(26 x 31.8 x 20.3 cm)
- WTBL20** Full-Size
20 1/2" L x 12 1/2" W x 8" H
(52.1 x 31.8 x 20.3 cm)

Beverage Inserts



- IBT65** 1/6-Size Insulated Insert for WTBL6
- IBT126** 1/3-Size Insulated Insert for WTBL12
- IBT200** Full-Size Polycarbonate Insert for WTBL20

Caddies

- WCBL4** 3 7/8" Sq. x 4 3/4" H
(9.8 x 12.1 cm)
- WCBL7** 7 1/2" L x 6 1/4" W x 4 3/4" H
(19.1 x 15.9 x 12.1 cm)

Black Twilight Nestable

Baskets

Organizing, displaying and storing has never been so stylish. These nestable, power-house baskets do it all. Perfect for keeping cups and dinnerware in the perfect places in dining halls or for displaying point of purchase snack options. Even use with beverage inserts to serve and chill drinks!

- BNRB6** 1/6-Size, 6 7/8" L x 6 3/8" W x 6" H
(17.5 x 16.2 x 15.2 cm)
- BNRB126** 1/3-Size, 12 1/2" L x 6 1/2" W x 6" H
(31.8 x 16.5 x 15.2 cm)
- BNRB129** Half-Size, 12 1/8" L x 10" W x 8" H
(30.8 x 25.4 x 20.3 cm)
- BNRB20** Full-Size, 20 3/8" L x 12 3/8" W x 8" H
(51.8 x 31.4 x 20.3 cm)

Beverage Inserts



- IBT65** 1/6-Size Insulated Insert for BNRB6
- IBT126** 1/3-Size Insulated Insert for BNRB126
- IBT125** Half-Size Insulated Insert for BNRB129
- IBT200** Full-Size Insulated Insert for BNRB20



AN EASY WAY TO ELEVATE DINING HALL PRESENTATION



WARNING: This product can expose you to chemicals including Bisphenol A (BPA), which is known to the State of California to cause birth defects or other reproductive harm. For more information, go to www.P65warnings.ca.gov. Warning applies to State of California only.



BEVDG20 shown with IBT200 liner

BEVDG129 shown with IBT125 liner

TUBS CAN BE FITTED WITH INSULATED AND POLYCARBONATE INSERTS

BEVDG6

BEVDG126 shown with IBT126 liner



BEVG129

BEVG20

BEVG6

BEVG126

Galvanized Beverage Tubs

In your choice of two galvanized colors, our beverage tubs are useful wherever thirst needs to be quenched en masse. These tubs have a tapered design for easy storage.

Onyx

- BEVDG6** 1/6-Size, 6" L x 6 1/4" W x 5 3/4" H (15.2 x 15.9 x 14.6 cm)
- BEVDG126** 1/3-Size, 12 1/4" L x 6" W x 5 3/4" H (31.1 x 15.2 x 14.6 cm)
- BEVDG129** Half-Size, 12 1/2" L x 9 7/8" W x 7 7/8" H (31.8 x 25.1 x 20 cm)
- BEVDG20** Full-Size, 20 1/2" L x 12" W x 8" H (52.1 x 30.5 x 20.3 cm)

Silver

- BEVG6** 1/6-Size, 6" L x 6 1/4" W x 5 3/4" H (15.2 x 15.9 x 14.6 cm)
- BEVG126** 1/3-Size, 12 1/4" L x 6" W x 5 3/4" H (31.1 x 15.2 x 14.6 cm)
- BEVG129** Half-Size, 12 1/2" L x 9 7/8" W x 7 7/8" H (31.8 x 25.1 x 20 cm)
- BEVG20** Full-Size, 20 1/2" L x 12" W x 8" H (52.1 x 30.5 x 20.3 cm)

Beverage Inserts



- IBT65** 1/6-Size Insulated Insert
- IBT126** 1/3-Size Insulated Insert
- IBT125** Half-Size Polycarbonate Insert
- IBT200** Full-Size Polycarbonate Insert

WARNING: This product can expose you to chemicals including Bisphenol A (BPA), which is known to the State of California to cause birth defects or other reproductive harm. For more information, go to www.P65warnings.ca.gov. Warning applies to State of California only.



BEV820 shown
with IBT200 liner

BEVB556 shown
with IBT65 liner

BEVB6612 shown
with IBT126 liner



BEVI220

BEVC1266 shown
with IBT126 liner

BEVC655 shown
with IBT65 liner

Rectangular Hammered Tubs

Perfect for cafeterias, parties and buffets, these stylishly retro hammered tubs can be fitted with insulated and polycarbonate inserts.

Black

BEVB556 1/6-Size, 6 1/4" L x 5 3/4" W x 5 3/4" H
(15.9 x 14.6 x 14.6 cm)

BEVB6612 1/3-Size, 12 1/4" L x 6 1/4" W x 6" H
(31.1 x 15.9 x 15.2 cm)

BEV820 Full-Size, 20 1/2" L x 12 1/2" W x 8" H
(52.1 x 31.8 x 20.3 cm)

Copper

BEVC655 1/6-Size, 6 1/4" L x 5 3/4" W x 5 3/4" H
(15.9 x 14.6 x 14.6 cm)

BEVC1266 1/3-Size, 12 1/4" L x 6 1/4" W x 6" H
(31.1 x 15.9 x 15.2 cm)

BEVI220 Full-Size, 20 1/2" L x 12 1/2" W x 8" H
(52.1 x 31.8 x 20.3 cm)

Beverage Inserts

IBT65 1/6-Size Insulated Insert

IBT126 1/3-Size Insulated Insert

IBT200 Full-Size Polycarbonate Insert



WARNING: This product can expose you to chemicals including Bisphenol A (BPA), which is known to the State of California to cause birth defects or other reproductive harm. For more information, go to www.P65warnings.ca.gov. Warning applies to State of California only.



Hammered Aluminum Beverage Tubs and Trays

Add a bit of charm to any occasion—from your next brunch buffet to a private table service for two. Available in multiple sizes, our Hammered Aluminum Beverage Tubs and Trays come in beautiful finishes for a striking look wherever they're placed.

Copper

- ATHC16** Tray, 16" Dia. x 2 ¾" H
(40.6 x 7 cm)
- ATHC9** Tub, 7 ¾ qt. (7.3 L)
12 ¼" L x 9" W x 8 ¾" H
(31.1 x 22.9 x 22.2 cm)
- ATHC10** Tub, 10 qt. (9.5 L)
15" L x 10 ¾" W x 7 ¼" H
(38.1 x 27.3 x 18.4 cm)
- ATHC14** Tub, 16 ¼ qt. (15.4 L)
19" L x 14" W x 8 ¼" H
(48.2 x 35.6 x 21 cm)

Gold

- ATHG16** Tray, 16" Dia. x 2 ¾" H
(40.6 x 7 cm)
- ATHG9** Tub, 7 ¾ qt. (7.3 L)
12 ¼" L x 9" W x 8 ¾" H
(31.1 x 22.9 x 22.2 cm)
- ATHG10** Tub, 10 qt. (9.5 L)
15" L x 10 ¾" W x 7 ¼" H
(38.1 x 27.3 x 18.4 cm)
- ATHG14** Tub, 16 ¼ qt. (15.4 L)
19" L x 14" W x 8 ¼" H
(48.2 x 35.6 x 21 cm)

Silver

- ATHS16** Tray, 16" Dia. x 2 ¾" H
(40.6 x 7 cm)
- ATHS9** Tub, 7 ¾ qt. (7.3 L)
12 ¼" L x 9" W x 8 ¾" H
(31.1 x 22.9 x 22.2 cm)
- ATHS10** Tub, 10 qt. (9.5 L)
15" L x 10 ¾" W x 7 ¼" H
(38.1 x 27.3 x 18.4 cm)
- ATHS14** Tub, 16 ¼ qt. (15.4 L)
19" L x 14" W x 8 ¼" H
(48.2 x 35.6 x 21 cm)

Black

- ATHB16** Tray, 16" Dia. x 2 ¾" H
(40.6 x 7 cm)
- ATHB9** Tub, 7 ¾ qt. (7.3 L)
12 ¼" L x 9" W x 8 ¾" H
(31.1 x 22.9 x 22.2 cm)
- ATHB10** Tub, 10 qt. (9.5 L)
15" L x 10 ¾" W x 7 ¼" H
(38.1 x 27.3 x 18.4 cm)
- ATHB14** Tub, 16 ¼ qt. (15.4 L)
19" L x 14" W x 8 ¼" H
(48.2 x 35.6 x 21 cm)





Black Wood Signs

Triangular wooden blocks feature sleek silver labels. Each measures 3" W x 1 3/4" H (7.6 x 4.4 cm).

- SIGNIT2** Iced Tea Sign
- SIGNSK9** Skim Milk Sign
- SIGND4** Decaf Sign
- SIGNC3** Coffee Sign
- SIGNHT1** Hot Tea Sign
- SIGNCR11** Cream Sign
- SIGNM8** Milk Sign
- SIGNW5** Hot Water Sign
- SIGNR6** Reserved Double-Sided Sign
- SIGNS7** No Smoking Double-Sided Sign
- SIGNCO** Carry-Out Pickup Double-Sided Sign

Laser Cut Signs

Silver

- SSD5** Decaf Sign
5" L x 3/4" W x 1 1/4" H
(12.7 x 1.9 x 3.2 cm)
- SSR5** Reserved Sign
5" L x 3/4" W x 1 1/4" H
(12.7 x 1.9 x 3.2 cm)
- SSC5** Coffee Sign
5" L x 3/4" W x 1 1/4" H
(12.7 x 1.9 x 3.2 cm)
- SSHW5** Hot Water Sign
5" L x 3/4" W x 1 1/4" H
(12.7 x 1.9 x 3.2 cm)

Black

- SBD5** Decaf Sign
5" L x 3/4" W x 1 1/4" H
(12.7 x 1.9 x 3.2 cm)
- SBR5** Reserved Sign
5" L x 3/4" W x 1 1/4" H
(12.7 x 1.9 x 3.2 cm)
- SBC5** Coffee Sign
5" L x 3/4" W x 1 1/4" H
(12.7 x 1.9 x 3.2 cm)
- SBHW5** Hot Water Sign
5" L x 3/4" W x 1 1/4" H
(12.7 x 1.9 x 3.2 cm)



Stainless Steel Card Sign

This semicircular stainless steel menu card makes it easy to write on with a Securit Chalk Marker (pg. 321).

SMS1 5" L x 2 1/2" W x 2 5/8" H
(12.7 x 6.4 x 6.7 cm)



SMS1

Stainless Steel Three-Sided Signs

With three messages on every sign, this is an easy way to identify with minimal effort.

TTSVG3 Vegan/Vegetarian/Gluten Free
4 3/4" L x 1 1/2" W x 1 3/8" H
(12.1 x 3.8 x 3.5 cm)

TTSB3 Coffee/Decaf/Hot Water
4 3/4" L x 1 1/2" W x 1 3/8" H
(12.1 x 3.8 x 3.5 cm)

TTMC3 Milk/Cream/Skim
4 3/4" L x 1 1/2" W x 1 3/8" H
(12.1 x 3.8 x 3.5 cm)



TTSVG3

Reserved Signs

Printed on both sides with classic, easily legible lettering.

2600 Plastic Standard Weight
6" L x 2" H (15.2 x 5.1 cm)

2601H Acrylic Heavy Weight
6" L x 2" H (15.2 x 5.1 cm)



2600



2601H



TTSB3



TTMC3



Deluxe Reservation Stands and Card Holders

CH Series made of all stainless steel. Weighted base measures 2 3/8" (6.7 cm). RS Series made of stainless steel with heavy weighted base. Mirror finish, 3 3/8" base (9.2 cm).

- CH4 4" H (10.2 cm)
- CH6 6" H (15.3 cm)
- CH8 8" H (20.3 cm)
- CH10 10" H (25.4 cm)
- RS12 12" H (30.5 cm)
- RS18 18" H (45.7 cm)

Low-Profile Menu and Card Holders

Choose from a range of styles and materials to match your dining room aesthetic.

- MH243** Nickel-Plated
2 1/4" Dia. x 2 1/2" H (5.7 x 6.4 cm)
- BMH221** Black Metal
1 1/2" Dia. x 1 1/2" H (3.8 x 3.8 cm)
- MH220** Stainless Steel
1 1/2" Dia. x 1 1/2" H (3.8 x 3.8 cm)

Heavy Plastic Table Numbers

If speed is the name of your game, it's hard to beat easily legible black numbers on heavy white plastic. Each measures 4" (10.2 cm) square.

- 450** Nos. 1-50
- 4100** Nos. 1-100
- 4150** Nos. 101-150

Mini Stainless Steel Number Tents

A stylish alternative to classic table numbers, these double-sided, embossed tents are crafted from dishwasher-safe, heat-tolerant stainless steel. 1" Sq. x 1 1/2" W (2.5 x 3.8 cm)

- EM199** Nos. 1-99
- EM1200** Nos. 1-200
- EM200** Nos. 201-400
- EM400** Nos. 401-600



MH243



BMH221

MH220



450

DOUBLE-SIDED FOR RAPID IDENTIFICATION



EM199

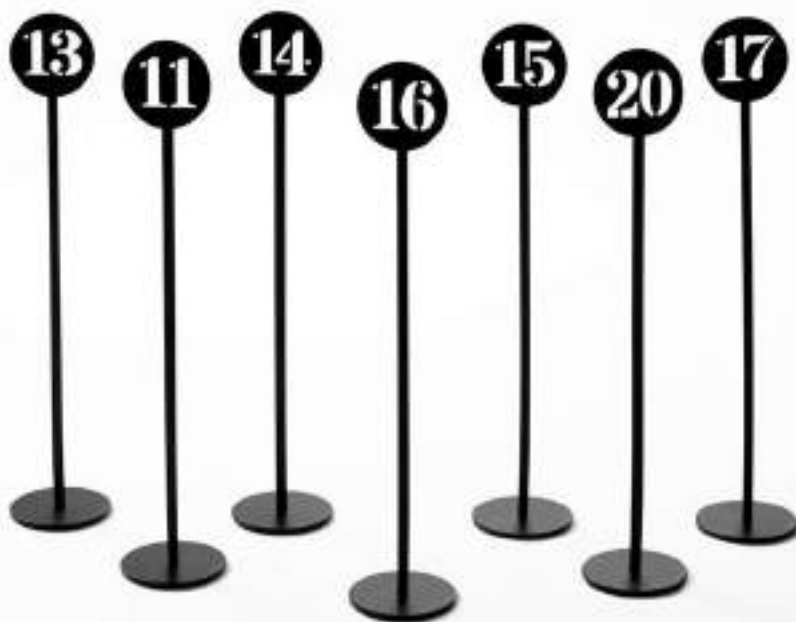

Stands shown from **NSB20**

Laser Cut Number Stands

The stamped-out numbers in these stands deliver more pizzazz than your average table-markers. In your choice of black or silver. 2" Dia. x 10" H (5.1 x 25.4 cm)

Black

- NSB10** Nos. 1-10
- NSB20** Nos. 11-20
- NSB30** Nos. 21-30
- NSB40** Nos. 31-40
- NSB50** Nos. 41-50

Silver

- NSC10** Nos. 1-10
- NSC20** Nos. 11-20
- NSC30** Nos. 21-30
- NSC40** Nos. 31-40
- NSC50** Nos. 41-50



Stands shown from **NSC10**

Harp Weighted Number Stands

Gold

- HPG4** 2 ¼" Dia. x 4" H
(5.7 x 10.2 cm)
- HPG6** 2 ¼" Dia. x 6" H
(5.7 x 15.2 cm)
- HPG8** 2 ¼" Dia. x 8" H
(5.7 x 20.3 cm)
- HPG12** 2 ¼" Dia. x 12" H
(5.7 x 30.5 cm)
- HPG18** 2 ¼" Dia. x 18" H
(5.7 x 45.7 cm)

Black

- HPBL4** 2 ¼" Dia. x 4" H
(5.7 x 10.2 cm)
- HPBL6** 2 ¼" Dia. x 6" H
(5.7 x 15.2 cm)
- HPBL8** 2 ¼" Dia. x 8" H
(5.7 x 20.3 cm)
- HPBL12** 2 ¼" Dia. x 12" H
(5.7 x 30.5 cm)
- HPBL18** 2 ¼" Dia. x 18" H
(5.7 x 45.7 cm)

Chrome

- HPCH4** 2 ¼" Dia. x 4" H
(5.7 x 10.2 cm)
- HPCH6** 2 ¼" Dia. x 6" H
(5.7 x 15.2 cm)
- HPCH8** 2 ¼" Dia. x 8" H
(5.7 x 20.3 cm)
- HPCH12** 2 ¼" Dia. x 12" H
(5.7 x 30.5 cm)
- HPCH18** 2 ¼" Dia. x 18" H
(5.7 x 45.7 cm)

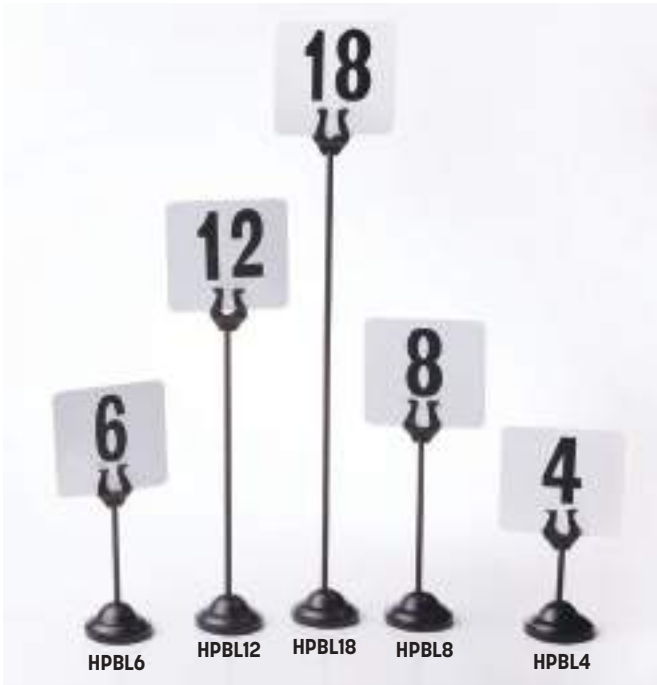

Geometric Card Holders

Display anything from menu cards to QR codes with these abstractly designed Geometric Card Holders. Available in popular colors and a variety of height options.

Silver

GCHS2 1 3/4" L x 1 1/8" W x 2" H
(4.4 x 2.9 x 5.1 cm)

GCHS3 2 5/8" L x 1 5/8" W x 3" H
(6.7 x 4.1 x 7.6 cm)

GCHS4 3 1/2" L x 2" W x 4" H
(8.9 x 5.1 x 10.2 cm)

Black

GCHB2 1 3/4" L x 1 1/8" W x 2" H
(4.4 x 2.9 x 5.1 cm)

GCHB3 2 5/8" L x 1 5/8" W x 3" H
(6.7 x 4.1 x 7.6 cm)

GCHB4 3 1/2" L x 2" W x 4" H
(8.9 x 5.1 x 10.2 cm)

Gold

GCHG2 1 3/4" L x 1 1/8" W x 2" H
(4.4 x 2.9 x 5.1 cm)

GCHG3 2 5/8" L x 1 5/8" W x 3" H
(6.7 x 4.1 x 7.6 cm)

GCHG4 3 1/2" L x 2" W x 4" H
(8.9 x 5.1 x 10.2 cm)

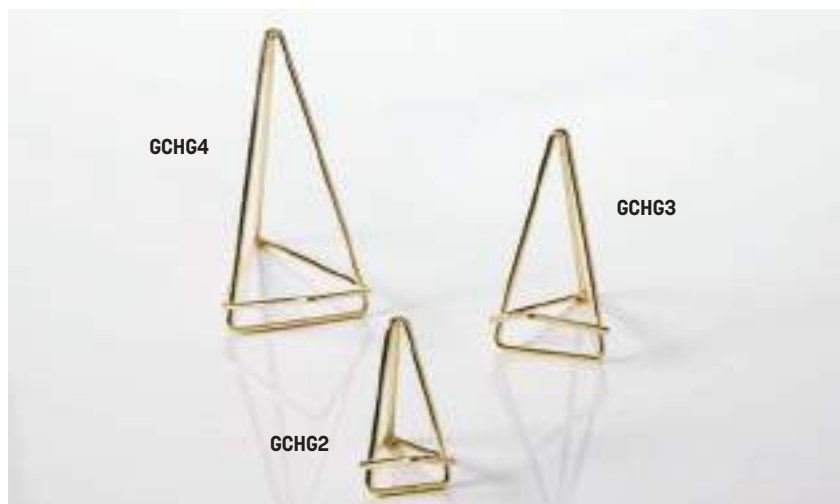
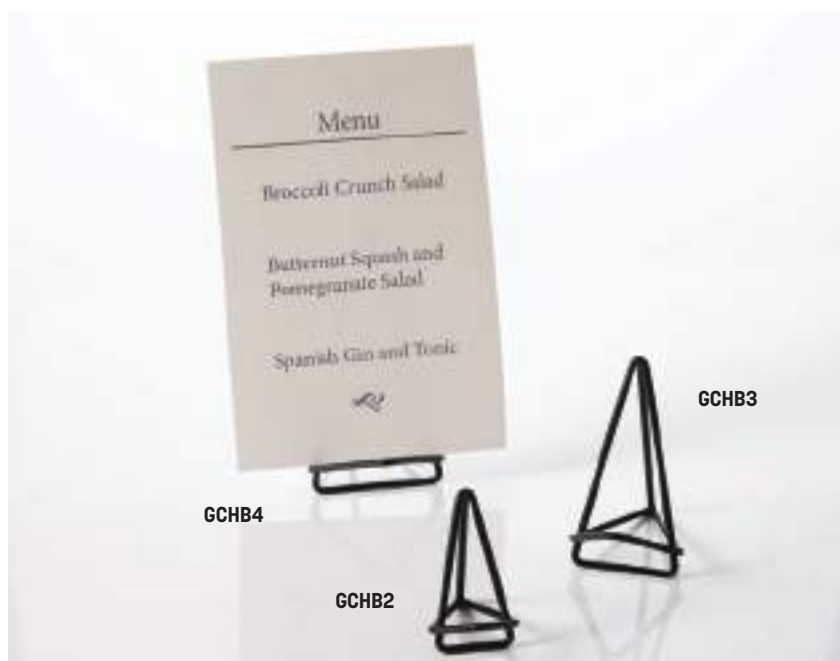



Chrome Spiral Number Holders

This playfully imaginative, spring-like design is available in two sizes.

SNC1 2 3/4" Dia. x 3" H
(6 x 7.6 cm)

MHSC6 2 1/4" Dia. x 6" H
(5.7 x 15.2 cm)

Swirl Base Number Stands

Chrome

NSC1 2" Dia. x 1 1/2" H
(5.1 x 3.8 cm)

NSC4 2 1/2" Dia. x 4" H
(6.4 x 10.2 cm)

NSC6 2 1/2" Dia. x 6" H
(6.4 x 15.2 cm)

NSC8 3" Dia. x 8" H
(7.6 x 20.3 cm)

NSC12 4" Dia. x 12" H
(10.2 x 30.5 cm)

Black

NSB1 2" Dia. x 1 1/2" H
(5.1 x 3.8 cm)

NSB4 2 1/2" Dia. x 4" H
(6.4 x 10.2 cm)

NSB6 2 1/2" Dia. x 6" H
(6.4 x 15.2 cm)

NSB8 3" Dia. x 8" H
(7.6 x 20.3 cm)

NSB12 4" Dia. x 12" H
(10.2 x 30.5 cm)

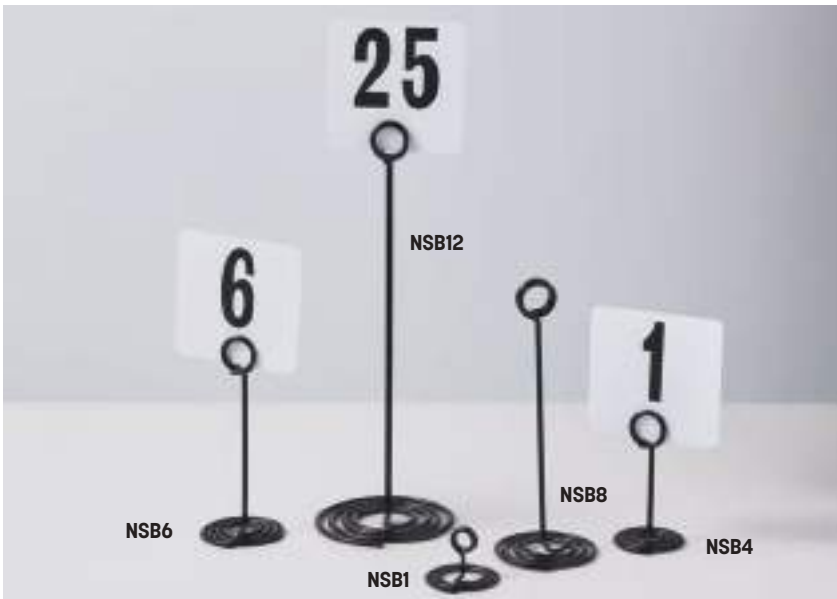
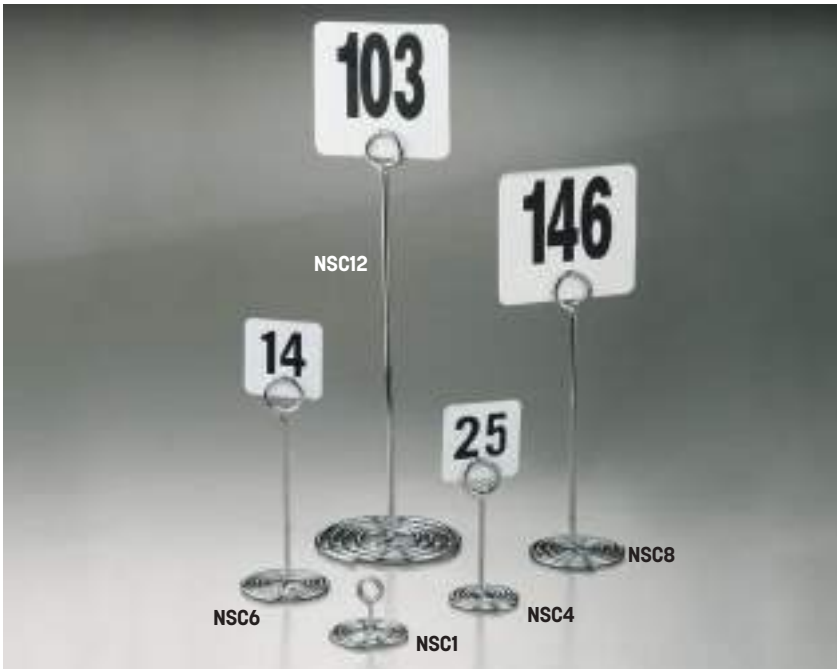

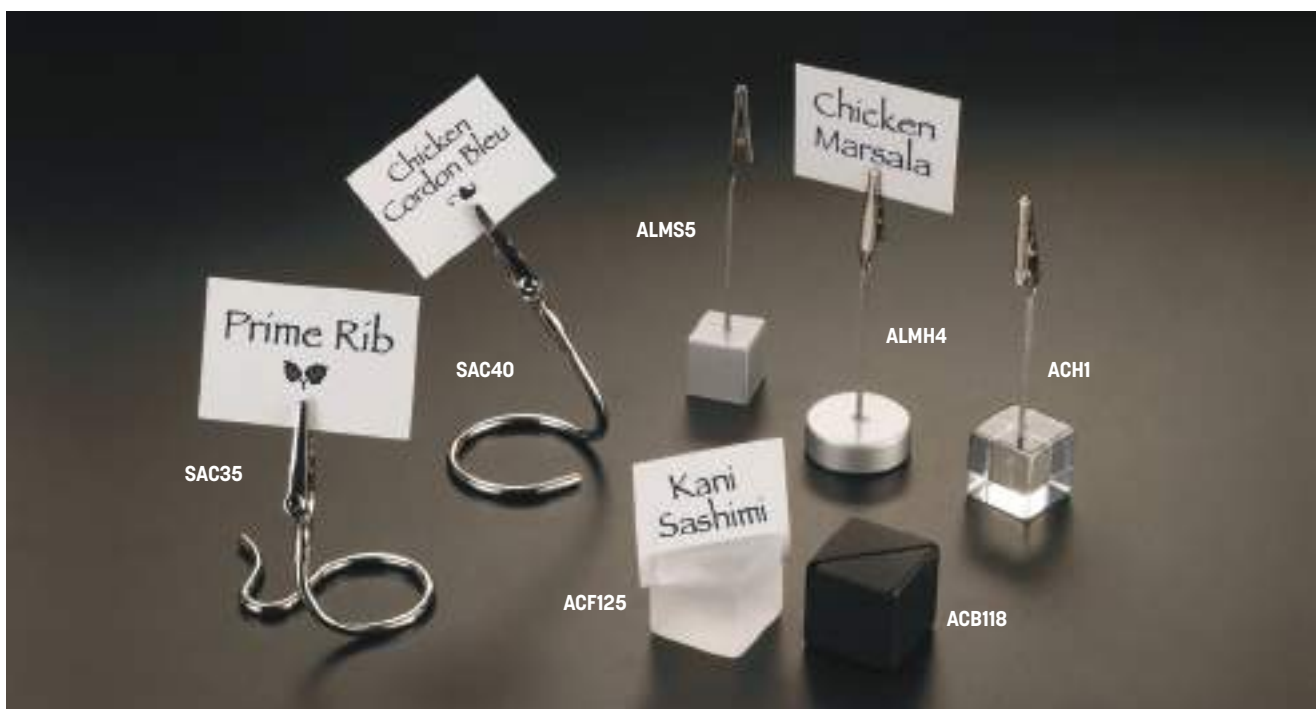

Card Holders

Choose from snappy alligator clips or sophisticated cubes to label buffets in a distinctive, contemporary way.

Swirly Alligator Clip Card Holders

SAC40 "C" Design
4" H (10.2 cm)

SAC35 "S" Design
3 ½" H (8.9 cm)

Aluminum Alligator Clip Card Holders

ALMH4 Round
4 ¼" H (10.8 cm)

ALMS5 Square
4 ¼" H (10.8 cm)

Acrylic Alligator Clip Card Holder

ACH1 Square
4 ¼" H (10.8 cm)

Acrylic Cube Card Holders

ACF125 Frosted White
1 ½" Sq. (2.9 cm)

ACB118 Black
1 ½" Sq. (2.9 cm)

Double-Sided Flexible Sign Clip

Clip these flexible, gravity-defying markers on trays, platters or bowls.

CLIPIT2 5 ¼" L x ½" W
(13.3 x 1.3 cm)

CLIPIT6 6" L x ½" W
(15.2 x 1.3 cm)



CLIPIT2 shown with TAGA8WT and TAGA7WT mini chalk cards



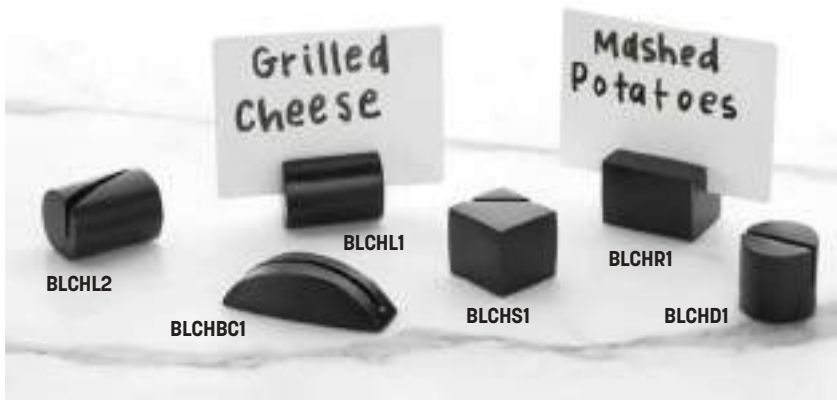

Hammered Aluminum Card Holders ▶

Each aspect of these head-turning designs is purposeful. Small stature keeps table space open, while hammered aluminum is heavy enough to stay in place.

Black

- BLCHL2** Angled Cut Cylinder
1 ¼" L x 7/8" W x 7/8" H
(3.2 x 2.2 x 2.2 cm)
- BLCHL1** Cylinder
1 ¼" L x 7/8" W x 7/8" H
(3.2 x 2.2 x 2.2 cm)
- BLCHBC1** Half Moon
2 ½" L x ¾" W x ¾" H
(5.4 x 1.9 x 1.9 cm)
- BLCHS1** Angled Cut Square
7/8" Sq. (2.2 cm)
- BLCHR1** Rectangular
1" L x 1 ¼" W x 1" H
(2.5 x 3.2 x 2.5 cm)
- BLCHD1** Round
7/8" Dia. x ¾" H
(2.2 x 1.9 cm)



Silver

- HCHL2** Angled Cut Cylinder
1 ¼" L x 7/8" W x 7/8" H
(3.2 x 2.2 x 2.2 cm)
- HCHL1** Cylinder
1 ¼" L x 7/8" W x 7/8" H
(3.2 x 2.2 x 2.2 cm)
- HCHBC1** Half Moon
2 ½" L x ¾" W x ¾" H
(5.4 x 1.9 x 1.9 cm)
- HCHS1** Angled Cut Square
7/8" Sq. (2.2 cm)
- HCHR1** Rectangular
1" L x 1 ¼" W x 1" H
(2.5 x 3.2 x 2.5 cm)
- HCHD1** Round
7/8" Dia. x ¾" H
(2.2 x 1.9 cm)



Copper

- BCHL2** Angled Cut Cylinder
1 ¼" L x 7/8" W x 7/8" H
(3.2 x 2.2 x 2.2 cm)
- BCHL1** Cylinder
1 ¼" L x 7/8" W x 7/8" H
(3.2 x 2.2 x 2.2 cm)
- BCHBC1** Half Moon
2 ½" L x ¾" W x ¾" H
(5.4 x 1.9 x 1.9 cm)
- BCHS1** Angled Cut Square
7/8" Sq. (2.2 cm)
- BCHR1** Rectangular
1" L x 1 ¼" W x 1" H
(2.5 x 3.2 x 2.5 cm)
- BCHD1** Round
7/8" Dia. x ¾" H
(2.2 x 1.9 cm)



BC1 shown with TAGA7WT mini chalk card

Cast Aluminum Card Holder ▶

- BC1** Half Moon
2 ½" L x ¾" W x ¾" H
(5.4 x 1.9 x 1.9 cm)

MCHW125 shown with TAGA6WT chalk card



MCHB125 shown with TAGA8WT chalk card



SRCH125

SRCH4 shown with TAGA7WT mini chalk card

Marble Card Holders

Add a touch of elegance to any setting with black or white marble.

MCHB125 Black
1 1/4" Sq. x 1" H
(3.2 x 2.5 cm)

MCHW125 White
1 1/4" Sq. x 1" H
(3.2 x 2.5 cm)

Round Rod Card Holders

Brushed stainless steel and minimalistic design resonate elegance. Fit a variety of card sizes in the 1/4" (0.64 cm) slit.

SRCH125 1 1/4" L x 5/8" H
(3.2 x 1.6 cm)

SRCH4 4" L x 5/8" H
(10.2 x 1.6 cm)



SSCH4 and SSCH125 shown with TAGA7WT mini chalk card

PERFECT FIT FOR MINI CHALK CARDS (PG. 321)

Square Rod Card Holders

Simple and functional, these stainless steel pieces hold all manner of cards.

Silver

SSCH125 3/8" Sq. x 1 1/2" L
(1 x 3.8 cm)

SSCH4 3/8" Sq. x 4 1/8" L
(1 x 10.5 cm)

Black

BCH125 3/8" Sq. x 1 1/2" L
(1 x 3.8 cm)

BCH4 3/8" Sq. x 4 1/8" L
(1 x 10.5 cm)



BCH4

BCH125

Stainless Steel Card Holders

Clever design takes up minimal table space, while brushed stainless steel is effortlessly cool.

DXCH1 2" L x 2" W x 3/4" H
(5.1 x 5.1 x 1.9 cm)



DXCH1

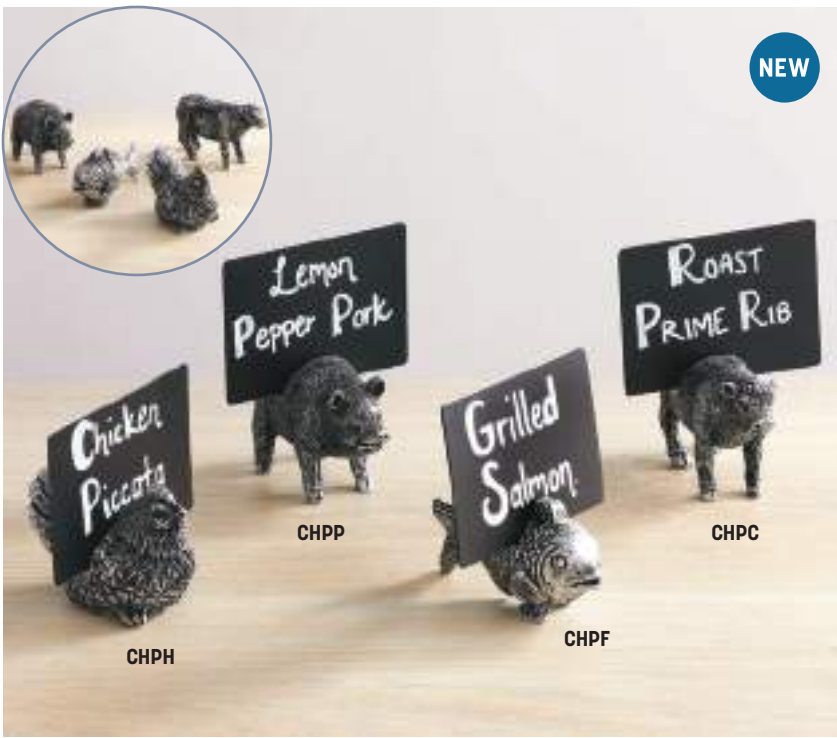

NEW

Whimsical Card Holders NEW

Add a touch of whimsy to your buffet! Featuring our favorite farmhouse friends, these card holders can creatively label corresponding dishes on the buffet or hold promotional menu specials or place cards on the tabletop.

- CHPH** Hen
2 3/8" L x 1 1/2" W x 1 7/8" H
(6 x 3.8 x 4.8 cm)
- CHPP** Pig
2 5/8" L x 1 1/2" W x 1 3/4" H
(6.7 x 3.8 x 4.4 cm)
- CHPF** Fish
2 3/4" L x 1 1/4" W x 1 5/8" H
(7 x 3.2 x 4.1 cm)
- CHPC** Cow
3" L x 1 3/8" W x 2" H
(7.6 x 3.5 x 5.1 cm)

Stone Card Holders

As though they've been plucked from a riverbed, these card holders create a fun, organic effect.

- CHBS** Black
1 1/4" L x 1" W x 1/2" H
(3.2 x 2.5 x 1.3 cm)
- CHGS** Gray
1 1/4" L x 1" W x 1/2" H
(3.2 x 2.5 x 1.3 cm)

Acrylic Card Holder Set

Fifty contemporary clear acrylic card holders in a convenient carrying case. **Sold in a set of 50.**

- LK50** 1 1/4" L x 1" W x 1/4" H
(3.2 x 2.5 x 0.6 cm)



LK50

Shown with TAGA8WT mini chalk card

INCLUDES CARRYING CASE THAT HOLDS ALL FIFTY CARD HOLDERS



BAMBL125

BAMCH125



BAMBL4

BAMCH4 shown with
TAGA7WT mini
chalk card

Bamboo Card Holders

Clean lines and contemporary styling draws customers' eyes to the cards.

BAMBL125 Black
1 1/4" L x 1 1/8" W x 3/4" H
(3.2 x 2.9 x 1.9 cm)

BAMCH125 Natural
1 1/4" L x 1 1/8" W x 3/4" H
(3.2 x 2.9 x 1.9 cm)

BAMBL4 Black
4" L x 1 1/8" W x 3/4" H
(10.2 x 2.9 x 1.9 cm)

BAMCH4 Natural
4" L x 1 1/8" W x 3/4" H
(10.2 x 2.9 x 1.9 cm)

Square Wood Card Holders

In olive wood or walnut, these cubes with rounded corners measure 1 1/8" Sq. (2.9 cm).

SOCH Olive Wood

SWCH Walnut

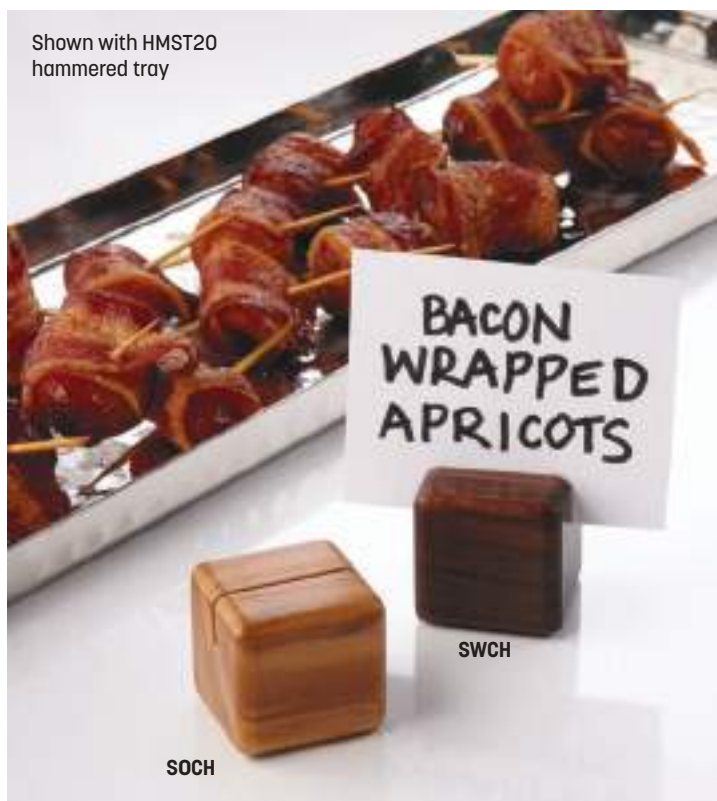
Shown with HMST20
hammered tray

SOCH

SWCH



CMCSW2

USE SECURIT MARKERS
(PG. 321) ON ANY OF
THESE SIGNS

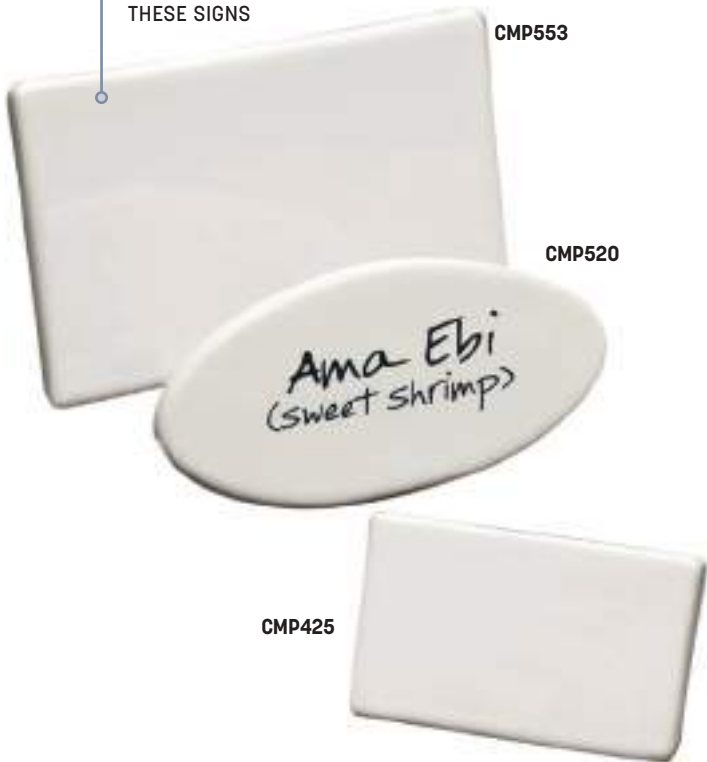

CMP553

CMP520

CMP425

Geometric Ceramic Card Signs

Write, wipe, repeat. These ceramic signs are endlessly reusable and appropriate for all levels of formality.

- CMCSW2** Rectangle
5" L x 2 1/4" W x 2 1/2" H
(12.7 x 5.7 x 6.4 cm)
- CMP553** Rectangle
5 1/2" L x 3 1/2" H
(14 x 8.9 cm)
- CMP520** Oval
5" L x 2 3/8" H
(12.7 x 6 cm)
- CMP425** Rectangle
3 3/4" L x 2 1/2" H
(9.5 x 6.4 cm)



Black Display Stands

Display promotional messages, QR menu codes, or provide a safe stand for cell phones with these versatile black display stands. Available in multiple sizes for individual needs.

- BDS2** 2" L x 3 3/8" W x 3 1/4" H
(5.1 x 8.6 x 8.3 cm)
- BDS3** 3" L x 5" W x 4 1/2" H
(7.6 x 12.7 x 11.4 cm)
- BDS4** 4 1/8" L x 6" W x 5 3/4" H
(10.5 x 15.2 x 14.6 cm)

Mini Chalk Cards

These mini blackboards fit into holders, clips and number stands. Each pack comes with its own White Securit Chalk Marker, four mini chalk card picks and two acrylic mini chalk card holders. **Sold in a pack of 20.**

- TAGA8WT** 3" L x 2" H (7.6 x 5.1 cm)
- TAGA7WT** 4" L x 3" H (10.2 x 7.6 cm)
- TAGA6WT** 6" L x 4" H (15.2 x 10.2 cm)



TAGA6WT shown with MCHW125 card holder

TAGA8WT shown with MCHB125 card holder

TAGA7WT shown with MCHB125 card holder

COMES WITH WHITE SECURIT MARKER THAT MAKES LABELING A CINCH



Tabletop Boards

Create custom messages and designs in your choice of size and finish. Removable, reusable blackboard included. Markers sold separately on pg. 321.

- ELEBSM** 4" W x 6" H
(10.2 x 15.2 cm)
- ELEBME** 6" W x 9" H
(15.2 x 22.9 cm)
- ELEBLA** 9" W x 12" H
(22.9 x 30.5 cm)

Tabletop Chalkboards

These stand-alone, one-piece boards are a modern way to elevate buffets, breakfast bars and display cases.

- TBABLA8** 2 7/8" L x 7/8" W x 2" H
(7.3 x 2.2 x 5.1 cm)
Pack of 5
- TBABLA7** 2 7/8" L x 1 3/8" W x 4 1/8" H
(7.3 x 3.5 x 10.5 cm)
Pack of 5
- TBABLA6** 4 1/8" L x 1 3/4" W x 5 7/8" H
(10.5 x 4.4 x 14.9 cm)
Pack of 3
- TBABLA5** 5 7/8" L x 3" W x 8 1/4" H
(14.9 x 7.6 x 21 cm)
Pack of 3



Mini Tabletop Sandwich Board

There are few more iconic forms of restaurant signage than the sandwich board. This tabletop mini sandwich board takes that classic look and brings it up-to-date, playfully announcing daily specials, drink deals and menu updates directly at the table where guests can't miss them.

- SBSBMNI** Plain, 6" W x 9 3/4" H
(15.2 x 24.8 cm)

Stencil Set

With these transparent stencil letters, numbers and symbols, anyone can make impressively professional signage.

- SECSTN5** Stencil Set
9" L x 13" W (22.9 x 33 cm)



SBSBMNI



SECSTN5

Securit®



Mini Tip



- FROM LEFT TO RIGHT**
 WHITE
 BLUE
 GREEN
 RED
 NEON YELLOW
 NEON PINK
 NEON ORANGE
 NEON PURPLE



SMA100WT BLSMA100V4WH BLSMA100V4CO BLSMA100V4TR



Small Tip



- FROM LEFT TO RIGHT:**
 WHITE
 BLUE
 GREEN
 RED
 YELLOW
 SLATE GRAY
 FORGET-ME-NOT
 MOSS GREEN
 BUTTERCUP
 GOLDEN YARROW
 HONEYSUCKLE
 JUBILEE CHERRY
 BURNT SIENNA



SMA510WT BLSMA510WT SMA510V4WT SMA510V4 SMA510V8ET

Original Chalk Markers

Great signage takes a bit of artistry, but just using a better medium will bring out your most inspired menus and promotions. These chalk markers are resistant to smudging, fading and light rain. Plus, they can be used on any non-porous surfaces and easily cleaned off with a soapy wet cloth.

Mini Tip Markers

- SMA100WT** White Mini Tip Bulk Pack
-
- BLSMA100V4WH** White Mini Tip Blister 4-Pack
-
- BLSMA100V4CO** Assortment Mini Tip Blister 4-Pack (White, Blue, Green, Red)
-
- BLSMA100V4TR** Assortment Tropical Mini Tip Blister 4-Pack (Neon Purple, Neon Yellow, Neon Pink, Neon Orange)
-

Small Tip Markers

- SMA510WT** White Small Tip Bulk Pack
-
- BLSMA510WT** White Small Tip Blister 2-Pack
-
- SMA510V4WT** White Small Tip 4-Pack
-
- SMA510V4** Assortment Small Tip 4-Pack (Green, Yellow, Blue, Red)
-
- SECSTN5** Earth Tone Assortment Small Tip 8-pack (Slate Gray, Forget-Me-Not, Moss Green, Buttercup, Golden Yarrow, Honeysuckle, Jubilee Cherry, Burnt Sienna)
-



Wood Menu Holders

These versatile clipboards and rubberband boards can be used for full-service menus, bar service and check presentation. In your choice of style, color and size.

Bamboo Clipboards

- BB8** 4" W x 8" H (10.2 x 20.3 cm)
- BB4** 4 ½" W x 12 ½" H (11.4 x 31.8 cm)
- BB12** 9" W x 12 ½" H (22.9 x 31.8 cm)
- BB15** 9" W x 15 ½" H (22.9 x 39.4 cm)

Bamboo Rubberband Boards

- BBR12** 4 ½" W x 12 ½" H (11.4 x 31.8 cm)
- BBRB** 9" W x 12 ½" H (22.9 x 31.8 cm)
- BBR15** 9" W x 15 ½" H (22.9 x 39.4 cm)

Espresso Clipboards

- CB8** 4" W x 8" H (10.2 x 20.3 cm)
- CB4** 4 ½" W x 12 ½" H (11.4 x 31.8 cm)
- CB12** 9" W x 12 ½" H (22.9 x 31.8 cm)
- CB15** 9" W x 15 ½" H (22.9 x 39.4 cm)

Espresso Rubberband Boards

- CBRB12** 4 ½" W x 12 ½" H (11.4 x 31.8 cm)
- CBRB** 9" W x 12 ½" H (22.9 x 31.8 cm)
- CBR15** 9" W x 15 ½" H (22.9 x 39.4 cm)

Classic Menu Holder and Bill Presenter

For more classical presentation, these holders feature a faux leather finish with gold lettering or design, gold corner reinforcements, an elastic cord and a two-page plastic insert.

MCCRLSBL Black Menu Holder
10" W x 13" H (25.4 x 33 cm)

MCCRBPBL Black Bill Presenter with Cash and Credit Card Sleeves
5" W x 9" H (12.7 x 22.9 cm)

MCCRLSBL



MCCRBPBL

Trendy Menu Holder and Bill Presenter

Details like a faux leather finish, double-sided stitching, debossed lettering, an elastic cord inside the spine and a two-page plastic insert make these a fantastic contemporary alternative to the traditional menu.

MCTRLSBL Black Menu Holder
10" W x 13" H (25.4 x 33 cm)

MCTRBPBL Black Bill Presenter with Cash and Credit Card Sleeve
5" W x 9" H (12.7 x 22.9 cm)

WITH STYLISH DOUBLE-SIDED STITCHING

MCTRBPBL



MCTRLSBL

Bill Presenter Treasure Box

The perfect way to end the meal! This Treasure Box can present bills, teas, even after-dinner treats.

MCBPBOXAN 6" L x 4" W x 4 1/4" H
(15.2 x 10.2 x 10.8 cm)



MCBPBOXAN



Bamboo Block Check Presenter

Your customers will remember this compact, ultra-contemporary way to pay.

WBB 3 1/2" L x 2 3/4" W x 3 1/4" H
(8.9 x 7 x 8.3 cm)



WBB

Stainless Steel Bill Presenter

MCBPBSS 7 1/4" L x 3 5/8" W x 1/2" H
(18.4 x 9.2 x 1.3 cm)

Black Bill Presenter

This simple PVC presenter features two-page clear plastic sleeves and a credit card sleeve.

MCBRBPBL 5" W x 9 3/8" H
(12.7 x 23.8 cm)



MCBPBSS



MCBRBPBL

EASY TO CLEAN AND
UPDATE ON THE FLY

HOT



WBWBL4060



WBWBL6080

Wall Boards

Natural black wood frames turn up the professionalism on these scratch-resistant boards. White Securit Chalk Marker, wall-mounting wire and hooks included.

WBWBL4060 15 3/4" W x 23 5/8" H (40 x 60 cm)

WBWBL6080 31 1/2" W x 23 5/8" H (80 X 60 cm)

Deluxe Sandwich Boards

The double-sided design and vibrant finishes on these premium sandwich boards make them ideal for catching eyes in high-traffic areas. Featuring robust, UV-resistant Securit writing surfaces that are suitable for all weather conditions.

Mahogany

SBDM85 21 1/2" L x 2 1/4" W x 33 1/2" H
(54.6 x 5.7 x 85.1 cm)
(not shown)

SBSM135 28 1/8" L x 2 3/8" W x 54 3/4" H
(71.4 x 6 x 139.1 cm)

Plain

SBDB85 21 1/2" L x 2 1/4" W x 33 1/2" H
(54.6 x 5.7 x 85.1 cm)
(not shown)

SBSB135 28 1/8" L x 2 3/8" W x 54 3/4" H
(71.4 x 6 x 139.1 cm)



SBSM135



SBSB135

Sandwich Boards

These simple, smartly-priced sandwich boards don't skimp on quality. Featuring natural black wood frames and scratch-resistant writing surfaces.

SBDBL85 21 1/2" L x 2 1/4" W x 33 1/2" H
(54.6 x 5.7 x 85.1 cm)

SBSBL120 27 1/4" L x 4" W x 49 1/4" H
(69.2 x 10.2 x 125.1 cm)
(not shown)



SBDBL85



SPRV1



SPRV2

Free-Standing Smoker Poles

Maintain a comfortable space for all customers with this modern, inconspicuous cigarette disposal. Featuring screw-off top (on free-standing pole) or bottom (on wall-mounted pole) for quick emptying. Intended for outdoor use only.

SPRV1 Brushed Stainless Steel
Free-Standing Smoker Pole & Base
9 3/4" Dia. x 40" H (24.8 x 101.6 cm)

SPRV2 Black
Free-Standing Smoker Pole & Base
9 3/4" Dia. x 40" H (24.8 x 101.6 cm)

Wall-Mounted Smoker Pole

SPSSWM2 Brushed Stainless Steel
Wall-Mounted Smoker Pole
2 1/2" Dia. x 22" H (6.4 x 55.9 cm)



SPSSWM2

BOTTOM SCREWS
OFF FOR EASY
EMPTYING



RBSS
(one set shown)

Value-Priced Barrier Systems

The ideal way to control a crowd and ensure social distancing measures are clearly displayed. With a low price tag and sleek, modern design, these sets are the perfect social distancing solution. Set includes two poles, two bases and black nylon tape. Signs sold separately.

RBSS 84" Tape x 35 1/4" H Posts
(213.4 x 89.5 cm)
12 1/2" (31.8 cm) Dia. Bases

RBSBL 84" Tape x 35 1/4" H Posts
(213.4 x 89.5 cm)
12 1/2" (31.8 cm) Dia. Bases

NEW VALUE-PRICED SETS



RBSBL
(one set shown)



USE WITH CORRESPONDING
VALUE-PRICED BARRIER
SYSTEM SIGNS TO DISPLAY
KEY INFORMATION



RBSIGNBL shown with RBSBL barrier system

Value-Priced Barrier System Signs

Display important social distancing instructions with this two-sided, stainless steel sign. Simply slide it over the top of the post for instant customer communication.

Satin

RBSIGNS Vertical, Fits RBSS
8 1/2" W x 11" H
(21.6 x 27.9 cm)

RBHSIGNS Horizontal, Fits RBSS
11" W x 8 1/2" H
(27.9 x 21.6 cm)

Black

RBSIGNBL Vertical, Fits RBSBL
8 1/2" W x 11" H
(21.6 x 27.9 cm)

RBHSIGNBL Horizontal, Fits RBSBL
11" W x 8 1/2" H
(27.9 x 21.6 cm)





RSRTRD
(four sets shown)

USABLE INDOOR OR OUTDOOR



RSRTGY
(two sets shown)

RSRTBK
(two sets shown)



RSBPBL (two sets shown)

ALL BARRIER SYSTEMS ARE FOR BOTH INDOOR AND OUTDOOR USE

Retractable Barrier Systems

This versatile set extends your choice of nylon tape up to 84" (213.4 cm). Resilient nylon allows you to control the flow of customers in al fresco settings too. Set includes one post, nylon tape and one base.

Red Tape

RSRTRD Brushed Stainless Steel Post & Base
Red Nylon Tape
84" Tape x 40" H Post (213.4 x 101.6 cm)
15" (38.1 cm) Dia. Base

RSRTRVSRDC1 Replacement Post for RSRTRD

Gray Tape

RSRTGY Brushed Stainless Steel Post & Base
Gray Nylon Tape
84" Tape x 40" H Post (213.4 x 101.6 cm)
15" (38.1 cm) Dia. Base

RSRTRVSGYC2 Replacement Post for RSRTGY

Black Tape

RSRTBK Brushed Stainless Steel Post & Base
Black Nylon Tape
84" Tape x 40" H Post (213.4 x 101.6 cm)
15" (38.1 cm) Dia. Base

RSRTRVSBLC4 Replacement Post for RSRTBK

Replacement Parts

RSRTRVSC3 Replacement Base

Black Retractable Barrier System

Our classic barrier system, now available in sleek black-on-black styling. Extends up to 84" (213.4 cm). For indoor and outdoor use. Set includes one post, nylon tape and one base.

RSBPBL Black Matte Post & Base
Black Nylon Tape
84" Tape x 40" H Post
(213.4 x 101.6 cm)
15" (38.1 cm) Dia. Base

RSRTBLC8 Replacement Post

RSRTBLC9 Replacement Base

Retractable Barrier System Set

RSRTLWCH (2) Brushed Stainless Steel Posts & Bases
Black Nylon Tape
84" Tape x 37" H Posts (213.4 x 93 cm)
13" (33 cm) Dia. Bases



RSRTLWCH
(one set shown)



RSSIGNBLK shown with RSBPBL barrier system



RSSIGNLSPS shown with RSRTBK barrier system

Retractable Barrier System Signs

Popular demand has prompted us to add these two-sided signs designed to be mounted on all Securit retractable barriers. Simply slide the sign over the top of the post for instant customer communication. Available in a satin and black finish, horizontal and vertical orientations.

Satin

RSSIGNLSPS Vertical, Fits RSRTRD, RSRTGY, RSRTBK and RSRTLWCH
8 ½" W x 11" H (21.6 x 27.9 cm)

RHSSIGNLSPS Horizontal, Fits RSRTRD, RSRTGY, RSRTBK and RSRTLWCH
11 ½" W x 8 ½" H (29.2 x 21.6 cm)

Black

RSSIGNBLK Vertical, Fits RSBPBL
8 ½" W x 11" H (21.6 x 27.9 cm)

RHSSIGNBLK Horizontal, Fits RSBPBL
11 ½" W x 8 ½" H (29.2 x 21.6 cm)

Sign Sets

Communicating to guests just got easier. We have taken the four most common statements and applied them to sleek black signage, perfect for any barrier sign. Sign set includes: Please Wait to be Seated, Please Enter Here, Section Closed and Carry-Out Pickup.

RBHMSG Horizontal Pack
10 ¾" W x 8" H (27.3 x 20.3 cm)

RBVMSG Vertical Sign Pack
8" W x 10 ¾" H (20.3 x 27.3 cm)



RHSSIGNBLK



RHSSIGNLSPS



RBVMSG



RBHMSG



RSCLG



RSCLC

Deluxe Rope Barrier Systems

Finished with gold or silver to give your customers the Hollywood treatment. Set includes one post and one base.

Gold

RSCLG Classic Barrier
Gold-Plated Post & Base
15" Dia. x 40" H (38.1 x 101.6 cm)

RSCLGOA1 Replacement Post

RSCLGOA2 Replacement Base

Silver

RSCLC Classic Barrier Polished Chrome
Flat Head Post & Base
15" Dia. x 40" H (38.1 x 101.6 cm)

RSCLCHB1 Replacement Post

RSCLCHB2 Replacement Base

Rope Barrier System Set

Crafted from mirror-polished, high-grade stainless steel and featuring an anti-scratch base. Ropes sold separately.

RSLWCH (2) Bases and (2) Posts
12 1/2" Dia. x 37 1/4" H
(31.8 x 94.6 cm)

Barrier System Braided Ropes

2" (5.1 cm) thick and 60" (5.1 x 152.4 cm) long, in an elegant braided style with your choice of metal finish. For both indoor and outdoor use.

RSCLRPGOBL Black - Gold Ends

RSCLRPCHBL Black - Chrome Ends



RSCLRPGOBL

RSCLRPCHBL



RSLWCH

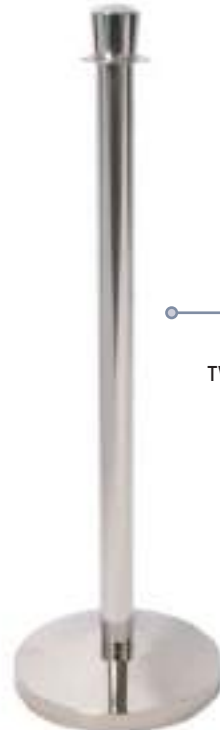

SET INCLUDES
TWO POSTS AND
TWO BASES

Bar Supplies





PERFECT FOR OUTDOOR
DINING DUE TO DURABLE
AND LIGHTWEIGHT DESIGN

DRINKWARE

Poolside dining. Outdoor patios. Rooftop Bars. Today's hottest dining trends call for durable drinkware that can withstand the rigors of an outside environment. Made of BPA-free Tritan™ copolyester, rest assured that our drinkware is lightweight, strong, stain-resistant and commercial dishwasher safe. The look of glass with the durability of plastic.

Crave Storm Collection NEW BPA FREE

Finish the look with beautiful, organically textured Tritan glasses from the Crave Storm Collection. Each tumbler gives the look of handmade glass with the durability of a shatter-resistant, dishwasher-safe Tritan copolyester construction.

BCR9ST Stackable Rocks
9 oz. (266.2 mL)
3 1/8" Dia. x 4 1/4" H (7.9 x 10.8 cm)

BCR15ST Stackable Double Old Fashioned
15 oz. (443.6 mL)
3 5/8" Dia. x 4 5/8" H (9.2 x 11.7 cm)

BCH18ST Stackable Highball
18 oz. (532.3 mL)
3 1/2" Dia. x 6 1/4" H (8.9 x 15.9 cm)



The Parker Collection

With the look of crystal but the durability of plastic, the Parker Collection's elegant sophistication will certainly turn heads. Made of Tritan copolyester, a shatter-resistant, ultra-strong, dishwasher-safe material.

- BPF8** Stemless Champagne Flute
9 oz. (266.2 mL)
2 3/8" Dia. x 5 1/2" H (6 x 14 cm)
- BPW13** Stemmed Wine/Drink Glass
13 oz. (384.5 mL)
4 1/8" Dia. x 8" H (10.5 x 20.3 cm)
- BPSW15** Stemless Wine Glass
15 oz. (443.6 mL)
3 1/2" Dia. x 4 1/2" H (8.9 x 11.4 cm)
- BPSW20** Stemless Wine Glass
20 oz. (591.5 mL)
3 3/4" Dia. x 5" H (9.5 x 12.7 cm)
- BPCL72** Carafe with Lid
72 oz. (2.1 L)
5" Dia. x 11" H (12.7 x 27.9 cm)
- BPWC7** Wine Bucket
7" Dia. x 7 3/4" H (17.8 x 19.7 cm)
- BPD13** Double Old Fashioned
13 oz. (384.5 mL)
3 5/8" Dia. x 4 3/8" H (9.2 x 11.1 cm)
- BPH21** Highball
21 oz. (621 mL)
3 1/2" Dia. x 6 3/4" H (8.9 x 17.1 cm)





HOT

BLH19

BLS14

BLR14

STACKABLE
DESIGN



BHH19

BHR14

Lilli Collection

HOT BPA FREE

Our Lilli Collection features a fresh embossed design that provides a nostalgic feel. Made with BPA-free Tritan copolyester, these glasses have the delicate look of glass with the durability of plastic.

BLR14 Double Old Fashioned
14 oz. (414 mL)
3 1/4" Dia. x 4 1/2" H (8.3 x 11.4 cm)

BLS14 Stackable Double Old Fashioned
14 oz. (414 mL)
3 3/8" Dia. x 4 1/2" H (8.6 x 11.4 cm)

BLH19 Highball
19 oz. (561.9 mL)
3 3/8" Dia. x 6 1/4" H (8.6 x 15.9 cm)

Hadley Collection

BPA FREE

Old-fashioned charm meets current fashion with the Hadley Collection. Featuring a cut crystal look, this line exudes pure elegance. Ideal for outdoor bars and lounges.

BHR14 Double Old Fashioned
14 oz. (414 mL)
3 3/8" Dia. x 4 1/2" H (8.6 x 11.4 cm)

BHH19 Highball
19 oz. (561.9 mL)
3 3/8" Dia. x 6 1/4" H (8.6 x 15.9 cm)

Shown with WBC36 water bottle



BSH20

BSR14

Sanibel Collection BPA FREE

A classic everyday look, the Sanibel Collection features a weighted base and cut crystal design. A perfect choice for ice cold water, cocktails or soft drinks, this line of clear, resilient Tritan drinkware provides a refreshing twist on a hot summer day.

BSR14 Double Old Fashioned
14 oz. (354.9 mL)
3 3/8" Dia. x 3 3/4" H (8.6 x 9.5 cm)

BSH20 Highball
20 oz. (591.5 mL)
3 1/8" Dia. x 6 1/8" H (7.9 x 15.6 cm)

Unity Collection BPA FREE

With a heavy base and slight taper, this crystal-clear Tritan line of glasses complements our Unity dinnerware collection entirely. This line is versatile for everyday use but also provides an upscale look.

BUR15 Double Old Fashioned
15 oz. (443.6 mL)
3" Dia. x 4 3/8" H (7.6 x 11.1 cm)

BUH18 Highball
18 oz. (532.3 mL)
2 3/4" Dia. x 6 1/4" H (7 x 15.9 cm)



BUH18

BUR15



OUR BIGGEST MUG MEASURES IN AT AROUND A GALLON AND A HALF (YES, REALLY) TO QUENCH EVEN THE THIRSTIEST CROWDS

CM96H

CM192H

Shown with
AWB12 rimmed oval ashwood serving board,
MDLR10 stainless steel muddler and
CM16H Moscow mule mug

MOSCOW MULE MUGS

In a range of sizes and finishes, our trendy Moscow Mule Mugs can accommodate individual drinks or shareable cocktails. Or, for an outside-the-box conversation piece, load them up with food.

Jumbo Hammered Copper Moscow Mule Mugs

CM96H 96 oz. (2.8 L)
6" Dia. x 6 5/8" H
8" W with Handle
(15.2 x 16.8, 20.3 cm)

CM192H 192 oz. (5.7 L)
7 1/2" Dia. x 8 1/8" H
9 1/2" W with Handle
(19.1 x 20.6, 24.1 cm)

Moscow Mule Mugs HOT

Copper/Brass

CM16H Hammered Finish
 16 oz. (473.2 mL)
 3 3/4" Dia. x 4 3/4" H
 4 3/4" W with Handle
 (9.5 x 12.1, 12.1 cm)

CM16P Mirror Finish
 16 oz. (473.2 mL)
 3 3/4" Dia. x 4 3/4" H
 4 3/4" W with Handle
 (9.5 x 12.1, 12.1 cm)

Gold/Brass

GM16H Hammered Finish
 16 oz. (473.2 mL)
 3 3/4" Dia. x 4 3/4" H
 4 3/4" W with Handle
 (9.5 x 12.1, 12.1 cm)

GM16P Mirror Finish
 16 oz. (473.2 mL)
 3 3/4" Dia. x 4 3/4" H
 4 3/4" W with Handle
 (9.5 x 12.1, 12.1 cm)

Black/Brass

BM16H Hammered Finish
 16 oz. (473.2 mL)
 3 3/4" Dia. x 4 3/4" H
 4 3/4" W with Handle
 (9.5 x 12.1, 12.1 cm)

BM16P Mirror Finish
 16 oz. (473.2 mL)
 3 3/4" Dia. x 4 3/4" H
 4 3/4" W with Handle
 (9.5 x 12.1, 12.1 cm)





THE ANTIQUE COPPER COLLECTION

Natural elements and minerals are on-trend. So it just made sense to add all of these copper mugs, tumblers, cocktail shakers and bar accessories to our line. Mix, stir, shake and toast... Here's to you.

Antique Copper Moscow Mule Tumblers

- ACT** Satin Finish
14 oz. (414 mL)
2 ¾" Dia. x 3 ½" H (7 x 8.9 cm)
- ACTH** Hammered Finish
14 oz. (414 mL)
2 ¾" Dia. x 3 ½" H (7 x 8.9 cm)

Antique Copper Moscow Mule Mugs

- ACM** Satin Finish
14 oz. (414 mL)
2 ¾" Dia. x 3 ½" H, 3 7/8" W with Handle
(7 x 8.9, 9.8 cm)
- ACMH** Hammered Finish
14 oz. (414 mL)
2 ¾" Dia. x 3 ½" H, 3 7/8" W with Handle
(7 x 8.9, 9.8 cm)

Antique Copper Cups

- ACC** Satin Finish
14 oz. (414 mL)
3 ½" Dia. x 3 ½" H (7.9 x 8.9 cm)
- ACCH** Hammered Finish
14 oz. (414 mL)
3 ½" Dia. x 3 ½" H (7.9 x 8.9 cm)



Martini Glass Servers

Use these stainless steel martini glasses for their obvious purpose or for serving snacks, appetizers and other finger foods.

MART1 10 oz. (295.7 mL)
5 7/8" Dia. x 8 1/4" H x 2 1/2" Deep
(14.9 x 21 x 6.4 cm)

JMART15 80 oz. (2.4 L)
9" Dia. x 15" H x 5 1/4" Deep
(22.9 x 38.1 x 13.3 cm)

Double-Wall Martini Glasses

In a satin or hammered stainless steel design, these glasses perform double duty for beverages or bar snacks.

DWC7 Satin Finish
7 oz. (207 mL)
4 1/2" Dia. x 3 3/4" H
(11.4 x 9.5 cm)

DWCH7 Hammered Finish
7 oz. (207 mL)
4 1/2" Dia. x 3 3/4" H
(11.4 x 9.5 cm)





Hammered Double-Wall Collins Glasses

Mix and serve over ice with these double-wall hammered Collins glasses. Available in durable stainless steel and in a variety of popular colors, each glass is designed to keep cocktails ultra-chilled without outer condensation. The experience is purely enjoyable.

HMCC14 Copper
14 oz. (414 mL)
2 5/8" Dia. x 6" H
(6.7 x 15.2 cm)

HMCB14 Black
14 oz. (414 mL)
2 5/8" Dia. x 6" H
(6.7 x 15.2 cm)

HMCS14 Silver
14 oz. (414 mL)
2 5/8" Dia. x 6" H
(6.7 x 15.2 cm)

Moroccan Tumbler

Whether you use this tumbler for creative beverage service or even more imaginative food presentation, it delivers a handcrafted aesthetic. Made of stainless steel.

HV3 Silver
12 oz. (354.9 mL)
3 1/4" Dia. x 4 1/4" H
(8.3 x 10.8 cm)



HV3

Shown with
FSLT10 faux slate
melamine platter

GREAT FOR FOOD OR DRINK

Hammered Double-Wall Cups and Tumblers

Make a splash at the bar with these hammered, mirrored-finish stainless steel designs in three different colors.

Copper

HMTC14 Mule Cup
14 oz. (414 mL)
3 1/2" Dia. x 4 1/2" H
(8.9 x 11.4 cm)

HMTC16 Tumbler
16 oz. (473.2 mL)
3 1/2" Dia. x 5 3/4" H
(8.9 x 14.6 cm)

Silver

HMTS14 Mule Cup
14 oz. (414 mL)
3 1/2" Dia. x 4 1/2" H
(8.9 x 11.4 cm)

HMTS16 Tumbler
16 oz. (473.2 mL)
3 1/2" Dia. x 5 3/4" H
(8.9 x 14.6 cm)

Black

HMTB14 Mule Cup
14 oz. (414 mL)
3 1/2" Dia. x 4 1/2" H
(8.9 x 11.4 cm)

HMTB16 Tumbler
16 oz. (473.2 mL)
3 1/2" Dia. x 5 3/4" H
(8.9 x 14.6 cm)



CREATIVE COCKTAILS CALL FOR CREATIVE CUPS, AND WE HAVE ONE FOR EVERY OCCASION



Shown with SST14 Royal Touch serving tray

Alternative Drinking Vessels

Mix up cups, bottles and jars to achieve creative, interesting service for beverages of all types.

- MJ17** Mason Jar
17 oz. (502.8 mL)
3" Dia. x 5 3/8" H (7.6 x 13.7 cm)
- GMB8** Glass Milk Bottle
8 oz. (236.6 mL)
2 1/4" Dia. x 5 1/2" H (5.7 x 14 cm)
- JC11** Mint Julep Cup
11 oz. (325.3 mL)
3" Dia. x 4 1/4" H (8.3 x 10.8 cm)
- HV3** Moroccan Tumbler
12 oz. (354.9 mL)
3 1/4" Dia. x 4 1/4" H (8.3 x 10.8 cm)
- MICH15** Stainless Steel Milk Can
15 oz. (443.6 mL)
2 3/4" Dia. x 5" H (7 x 12.7 cm)
- GMB16** Glass Milk Bottle
16 oz. (473.2 mL)
2 3/4" Dia. x 6 1/2" H (7 x 16.5 cm)
- GJ8** Square Glass Jar
8 oz. (236.6 mL)
3" Sq. x 3" H (7.6 x 7.6 cm)
- MJ85** Mason Jar
8 1/2 oz. (250 mL)
3" Dia. x 3 1/2" H (7.6 x 8.9 cm)



Classic Mint Julep Cups

Featuring elegant beading and a mirrored finish, these stunning cups will have your mint julep presentation off to the races.

- JC12** 12 oz. (354.9 mL)
3 3/8" Dia. x 4 1/2" H (8.6 x 11.4 cm)
- JC16** 16 oz. (473.2 mL)
3 5/8" Dia. x 5 3/4" H (9.2 x 14.6 cm)

Mint Julep Cups

Make every day Derby Day with these sleek Mint Julep Cups crafted from brushed stainless steel.

- JC8** 8 oz. (236.6 mL)
2 7/8" Dia. x 3 7/8" H (7.4 x 9.8 cm)
- JC11** 11 oz. (325.3 mL)
3" Dia. x 4 1/4" H (7.6 x 10.8 cm)
- JC14** 14 oz. (414 mL)
3 1/4" Dia. x 4 5/8" H (8.3 x 11.8 cm)

Carbonized Bamboo Flight Boards

The rich color of these flight boards brings out the best in brews and bites alike.

BWF4 Flight Board
 13 7/8" L x 3 3/8" W x 1 1/4" H
 (35.2 x 8.6 x 3.2 cm)

BWF3 Pairing Flight Board
 13 7/8" L x 6 7/8" W x 1 1/4" H
 (35.2 x 17.5 x 3.2 cm)



Shown with BHR14 drinkware and BSS12 bar spoon



Shown with MSTNG5 tongs

COCKTAIL PREP

With the cocktail craze in full swing, it's not enough to make great drinks. You have to look good doing it. As mixology methods become more refined, bartending experts look to step up their game with accessories that match their liquid assets. These pieces raise the bar for preparation and presentation.

Cocktail Mixing Tins

Mix up ice cold cocktails with a modern twist with these stainless steel mixing tins. Featuring a contemporary satin-finished design, each drink will pour with ease from the precision spout. Durable and dishwasher safe.

MTS20 20 oz. (591.5 mL)
3 3/8" Dia. x 4 1/4" H (8.6 x 10.8 cm)

MTS26 26 oz. (768.9 mL)
3 1/2" Dia. x 5" H (8.9 x 12.7 cm)

MTS32 32 oz. (946.4 mL)
4" Dia. x 5 1/2" H (10.2 x 14 cm)

Cocktail Mixing Glasses

In 20, 25 and 30 oz. capacities, this barware is available in stemmed, clear, diamond and hand-cut glass designs.

Clear

MGC20 20 oz. (591.5 mL)
3 1/2" Dia. x 5 1/4" H (8.9 x 13.3 cm)

MGC25 25 oz. (739.3 mL)
3 1/2" Dia. x 6 1/2" H (8.9 x 16.5 cm)

Diamond

MGD20 20 oz. (591.5 mL)
3 1/2" Dia. x 5 1/4" H (8.9 x 13.3 cm)

MGD25 25 oz. (739.3 mL)
3 1/2" Dia. x 6 1/2" H (8.9 x 16.5 cm)

Hand-Cut

MGL20 20 oz. (591.5 mL)
3 1/2" Dia. x 5 1/4" H (8.9 x 13.3 cm)

MGL25 25 oz. (739.3 mL)
3 1/2" Dia. x 6 1/2" H (8.9 x 16.5 cm)



BEAUTIFUL
DIAMOND
PATTERN

Glass Bitters Bottles

Choose from three different designs that include a stainless steel and silicone stopper.

BB2 Clear
4 oz. (118.3 mL)
2 1/2" Dia. x 5 1/2" H (6.4 x 14 cm)

BBC2 Diamond
4 oz. (118.3 mL)
2 1/2" Dia. x 5 1/2" H (6.4 x 14 cm)

BBRC Replacement Stainless Steel
and Silicone Dasher (not shown)
1" Dia. x 2 1/2" H (2.5 x 6.3 cm)



GORGEOUS
HAND-CUT
DESIGN



BEAUTIFUL
DIAMOND
DETAILS

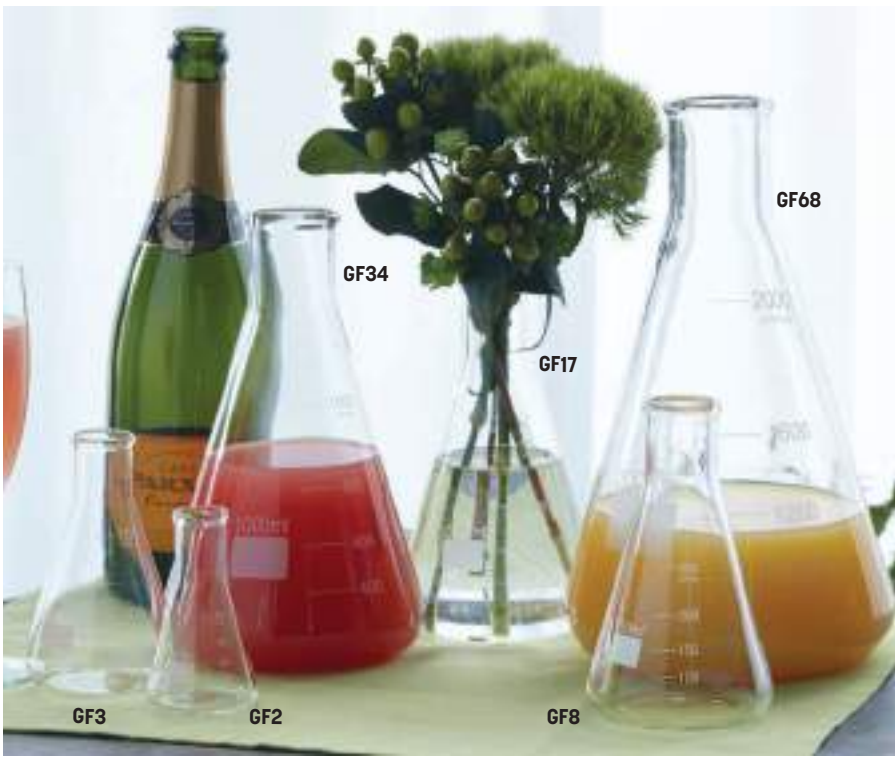

THE CHEMISTRY COLLECTION

Create your most inspired concoctions with these flasks and beakers that make even classic cocktails feel experimental. Capacity markings make measuring easy.

Glass Chemistry Flasks

- GF2** 1 ¾ oz. (50 mL)
2" Dia. x 3 ¾" H (5.1 x 9.5 cm)
- GF3** 5 oz. (150 mL)
3" Dia. x 4 ¾" H (7.6 x 12.1 cm)
- GF8** 8 ½ oz. (250 mL)
3 ½" Dia. x 5 ¾" H (8.9 x 14.6 cm)
- GF17** 17 oz. (500 mL)
4" Dia. x 7" H (10.2 x 17.8 cm)
- GF34** 34 oz. (1000 mL)
5" Dia. x 8 ¾" H (12.7 x 22.2 cm)
- GF68** 68 oz. (2000 mL)
6 ½" Dia. x 11" H (16.5 x 27.9 cm)

Glass Chemistry Beakers

- GBE2** 1 ¾ oz. (50 mL)
1 ¾" Dia. x 2 ¼" H (4.5 x 5.7 cm)
- GBE3** 3 ½ oz. (100 mL)
2 ½" Dia. x 3" H (6.4 x 7.6 cm)
- GBE8** 8 ½ oz. (250 mL)
3" Dia. x 4" H (7.6 x 10.2 cm)
- GBE17** 17 oz. (500 mL)
3 ¼" Dia. x 5" H (8.3 x 12.7 cm)
- GBE34** 34 oz. (1000 mL)
4 ¼" Dia. x 5 ¼" H (10.8 x 13.3 cm)
- GBE64** 64 oz. (2000 mL)
5 ¼" Dia. x 7 ½" H (13.3 x 19.1 cm)



CAPACITIES ARE CLEARLY MARKED



Glass Water Bottles and Stoppers

Mix and match two styles of carafes and three styles of stoppers to elevate your H₂O. Bottles and stoppers sold separately.

Glass Water Bottles

- GCD28** Diamond
29 oz., 28 oz. to Shoulder (0.9 L, 0.8 L)
3 1/8" Dia. x 10 1/4" H (7.9 x 26 cm)
- GCH28** Pebbled
29 oz., 28 oz. to Shoulder (0.9 L, 0.8 L)
3 1/8" Dia. x 10 1/4" H (7.9 x 26 cm)

Glass and Silicone Bottle Stoppers

- GSB2** Blue Marble, 1 3/4" Dia. x 2 3/4" H (4.4 x 7 cm)
- GSC2** Clear, 1 3/4" Dia. x 2 3/4" H (4.4 x 7 cm)
- GSF2** Frosted, 1 3/4" Dia. x 2 3/4" H (4.4 x 7 cm)

Glass Carafes

With smaller sizes for individual servings of beverages and larger sizes for shared drinks, these elegantly curved carafes are a stylish addition to any brunch or dinner service.

Multi-Serving

- GC36** 36 oz., 34 oz. to Shoulder (1.1 L, 1 L)
4" Dia. x 9 1/2" H (10.2 x 24.1 cm)
- GC34** 34 oz., 16 oz. to Shoulder (1 L, 473.2 mL)
4" Dia. x 9 1/2" H (10.2 x 24.1 cm)

Single-Serving

- GC12** 12 oz., 10.5 oz. to Shoulder (354.9 mL, 310.5 mL)
3 1/4" Dia. x 4 3/4" H (8.2 x 12 cm)
- GC8** 8 oz., 3 oz. to Shoulder (236.6 mL, 88.7 mL)
3" Dia. x 4 3/4" H (7.6 x 12 cm)





Clear Acrylic Water Bottles

In a quartet of distinct styles, these one-liter acrylic bottles make even simple beverages photogenic. Cap included.

WB32 Clear, 34 oz. (1 L)
 3 1/2" Dia. x 11 1/4" H
 (8.9 x 28.6 cm)

WB33 Fluted, 34 oz. (1 L)
 3 1/2" Dia. x 11 1/4" H
 (8.9 x 28.6 cm)

WB34 Pebbled, 34 oz. (1 L)
 3 1/2" Dia. x 11 1/4" H
 (8.9 x 28.6 cm)

WB35 Diamond 34 oz. (1 L)
 3 1/2" Dia. x 11 1/4" H
 (8.9 x 28.6 cm)

WBCAP Replacement Cap
 1" Dia. x 1" H
 (2.5 x 2.5 cm)



Stainless Steel Tapered Pourer

Turn one of our Clear Acrylic Water Bottles into a jumbo-sized mixer bottle with this pourer made from stainless steel and plastic cork. It's a memorable way to give your bar an extra splash of panache. **Sold in a pack of 12.**

DPR1 Stainless Steel Pourer
 Fits WB32, WB33, WB34, WB35
 1 3/4" Dia. x 4 3/4" H
 (4.4 x 12.1 cm)



Hinged Acrylic Water Bottles

Our original take on a popular style, these gasketed bottles are designed to keep out contaminants.

WBC34 Clear, 34 oz. (1 L)
 4 1/8" Dia. x 11 5/8" H (10.5 x 29.5 cm)

WBC36 Clear, 36 oz. (1.1 L)
 3 3/8" Dia. x 11 1/8" H (8.6 x 28.3 cm)

Pebbled Acrylic Water Bottle

Inspired by our pebbled glass water bottle, this piece is made from plastic for extra durability. Cap included.

WBP34 Clear, 34 oz. (1 L)
 3 7/8" Dia. x 11 5/8" H (8.9 x 29.5 cm)

WBPCAP Replacement Cap
 2 1/4" Dia. x 5/8" H (5.7 x 1.6 cm)



Cocktail Smoking Dome Cover

Smoking cocktails has never been easier with this crystal-clear polycarbonate dome cover. Complete with a silicone valve that accommodates most smoking guns, this durable dome is designed to keep smoke in while cocktails and other menu items get properly flavored.

SLFTD8 8 ¼" Dia. x 8 ½" H
(21 x 21.6 cm)



SMOKING GUN
SOLD SEPARATELY

SLFTD8

Shown with MWP9 plate and BHR14 drinkware

Black Silicone Ice Molds

All are made of dishwasher-safe, BPA-free, food-safe silicone and withstand temperatures from -4° F (-20° C) to 392° F (200° C). Molds create perfectly round or square ice.

Sphere Molds

SMSR4 (4) 2 ½" Dia. (6.4 cm)
4 oz. (118.3 mL)
6 ⅞" Sq. x 2 ½" H (15.6 x 6.4 cm)
Tray with Lid

SMSR8 (6) 1 ½" Dia. (3.8 cm)
1 ¾ oz. (51.8 mL)
7" L x 4 ⅝" W x 1 ½" H
(17.8 x 11.7 x 3.8 cm)
Tray with Lid



SMSR8

SMSR4

Cube Molds

SMSC4 (4) 2" Sq. (5.1 cm)
3 ½ oz. (103.5 mL)
4 ½" Sq. x 2" H (11.4 x 5.1 cm)
Tray with Lid

SMSC8 (8) 2" Sq. (5.1 cm)
3 ½ oz. (103.5 mL)
8 ½" L x 4 ½" W x 2" H
(21.6 x 11.4 x 5.1 cm)



SMSC4

SMSC8



WARNING: This product can expose you to chemicals including Bisphenol A (BPA), which is known to the State of California to cause birth defects or other reproductive harm. For more information, go to www.P65warnings.ca.gov. Warning applies to State of California only.



BSSET

Boston Shaker Sets

Chill it, shake it and serve it! These weighted satin-finish stainless steel tins fit firmly together to mix up your favorite cocktails. Available in a set or as individual sizes. Gold color may vary slightly.

Silver

BSSET Set, 18 oz. (532.3 mL)
 3 3/8" Dia. x 5 1/4" H (8.6 x 13.3 cm)
 28 oz. (828.1 mL)
 3 5/8" Dia. x 7" H (9.2 x 17.8 cm)

BS18 Replacement Cup, 18 oz. (532.3 mL)
 3 3/8" Dia. x 5 1/4" H (8.6 x 13.3 cm)

BS28 Replacement Cup, 28 oz. (828.1 mL)
 3 5/8" Dia. x 7" H (9.2 x 17.8 cm)

Gold

GBSSET Set, 18 oz. (532.3 mL)
 3 3/8" Dia. x 5 1/4" H (8.6 x 13.3 cm)
 28 oz. (828.1 mL)
 3 5/8" Dia. x 7" H (9.2 x 17.8 cm)

GBS18 Replacement Cup, 18 oz. (532.3 mL)
 3 3/8" Dia. x 5 1/4" H (8.6 x 13.3 cm)

GBS28 Replacement Cup, 28 oz. (828.1 mL)
 3 5/8" Dia. x 7" H (9.2 x 17.8 cm)



DISHWASHER-SAFE
FINISH

GBSSET

NEW

Antique Copper Cocktail Shakers

Part of our award-winning Antique Copper Collection, these cocktail shakers do more than mix drinks—they spark conversations.

ACS Satin, 24 oz. (710 mL)
 4" Dia. x 9 1/4" H (10.2 x 23.5 cm)

ACSH Hammered, 24 oz. (710 mL)
 4" Dia. x 9 1/4" H (10.2 x 23.5 cm)

Beehive Cocktail Shakers

These three-piece beehive stainless steel shakers feature a high-polished mirror finish on the shaker, strainer top and jigger cap.

BHS109 8 oz. (240 mL)
 2 5/8" Dia. x 6 3/8" H (6.7 x 16.2 cm)

BHS117 16 oz. (470 mL)
 3 1/4" Dia. x 8" H (8.3 x 20.3 cm)

BHS124 24 oz. (710 mL)
 3 1/2" Dia. x 8 7/8" H (8.9 x 22.5 cm)



ACS

ACSH



BHS109

BHS124

BHS117

Three-Piece Cocktail Shakers HOT 

- CSJ108** 8 oz. (240 mL)
3 1/8" Dia. x 5 3/4" H (7.9 x 14.6 cm)
- CSJ116** 16 oz. (470 mL)
3 1/8" Dia. x 7 1/2" H (7.9 x 19.1 cm)
- CSJ174** 28 oz. (830 mL)
4" Dia. x 8 1/4" H (10.2 x 21 cm)

Replacement Jigger Cup

- CSJCUP** 3 oz. (89 mL) (not shown)
2" Dia. x 2 1/4" H (5.1 x 5.7 cm)

Cocktail Shakers and Malt Cup

- CS080** Shaker
8 oz. (240 mL)
3" Dia. x 3 1/4" H (7.6 x 8.3 cm)
- CS200** Shaker
16 oz. (470 mL)
3 3/4" Dia. x 4 5/8" H (9.5 x 11.7 cm)
- CS100** Shaker
28 oz. (800 mL)
3 5/8" Dia. x 7" H (9.2 x 17.8 cm)
- MM100** Malt Cup
32 oz. (950 mL)
4 1/8" Dia. x 7" H (10.5 x 17.8 cm)

Bar Glass/Mixing Glass USA

- MG578** 16 oz. (470 mL)
3 3/8" Dia. x 5 7/8" H (8.6 x 14.9 cm)



COMES COMPLETE WITH INSCRIBED RECIPES





Japanese-Style Stainless Steel Jiggers

- JG2** ½ oz. x ¾ oz. (14.8 x 22.2 mL)
- JG1** ½ oz. x 1 oz. (14.8 x 29.6 mL)
- JG12** ½ oz. x 1 ½ oz. (14.8 x 44.4 mL)
- JG14** ½ oz. x 1 ¼ oz. (14.8 x 37 mL)
- JG22** 1 oz. x 1 ¼ oz. (29.6 x 37 mL)
- JG2A** ¾ oz. x 1 ¼ oz. (22.2 x 37 mL)
- JG3** ¾ oz. x 1 ½ oz. (22.2 x 44.4 mL)
- JG4** 1 oz. x 1 ½ oz. (29.6 x 44.4 mL)
- JG5** 1 oz. x 2 oz. (29.6 x 59.1 mL)
- JG63** 1 ¼ oz. x 2 oz. (37 x 59.1 mL)

Stainless Steel Jiggers

- J202** ½ oz. x ¾ oz. (14.8 x 22.2 mL)
- J201** ½ oz. x 1 oz. (14.8 x 29.6 mL)
- J214** ½ oz. x 1 ¼ oz. (14.8 x 37 mL)
- J212** ½ oz. x 1 ½ oz. (14.8 x 44.4 mL)
- J208** ⅝ oz. x 1 ¼ oz. (18.5 x 37 mL)
- J206** ¾ oz. x 1 oz. (22.2 x 29.6 mL)
- J202A** ¾ oz. x 1 ¼ oz. (22.2 x 37 mL)
- J203** ¾ oz. x 1 ½ oz. (22.2 x 44.4 mL)
- J222** 1 oz. x 1 ¼ oz. (29.6 x 37 mL)
- J204** 1 oz. x 1 ½ oz. (29.6 x 44.4 mL)
- J205** 1 oz. x 2 oz. (29.6 x 59.1 mL)
- J263** 1 ¼ oz. x 2 oz. (37 x 59.1 mL)
- J266** 1 ½ oz. x 2 oz. (44.4 x 59.1 mL)



Evolution Tongs

These stainless steel tongs feature a 21st-century design with ergonomic styling.

- TGS8** 7 ¼" L (18.4 cm)
- TGS6** 6" L (15.2 cm)
- TGS9** 9 ½" L (24.1 cm)
- TGS12** 12" L (30.5 cm)

Serving Tongs

These versatile brushed stainless steel tongs can be used for anything from bread to ice cubes.

TG8 Solid
8 ½" L (21.6 cm)

TGP8 Perforated
8 ½" L (21.6 cm)

Stainless Steel Utility Tongs

Your basic utility tongs never go out of style.

UT707 7" L (17.8 cm)

Stainless Steel Ice Tongs

The serrated claws on these short tongs make gripping a breeze when time is at a premium.

MSTNG5 5" L (12.7 cm)



Shown with GBE8 glass beaker



Stainless Steel Bar Whisks

Cocktailing is an art. These whisks are a mixologist's right-hand memory maker.

- SBW5** Square
5" L (12.7 cm)
- SBW7** Square
7" L (17.8 cm)
- SBW9** Round
9" L (22.9 cm)
- SBW10** Square
10 ½" L (26.6 cm)

Stainless Steel Bar Utensils

The bartender's arsenal of tools, all in one stylish collection. Each utensil is crafted from stainless steel and tipped with black rubber.

- SZ56** Zester
6 ¾" L (17.1 cm)
- SM9** Cocktail Muddler
9 ⅛" L (23.2 cm)

NEW



MWW10

MAW10

Wood Muddlers NEW

Perfect for crushing fruits and herbs for delicious cocktails. Designed with a flat end to easily crush ingredients together.

MAW10 Acacia
10" L (25.4 cm)

MWW10 Walnut
10" L (25.4 cm)

Stainless Steel Muddlers

These muddlers are expertly designed with ridges and rounded edges to offer a tighter and more comfortable grip in your hand.

MDLR7 7" L (17.8 cm)

MDLR10 10" L (25.4 cm)



MDLR10

MDLR7

Plastic Muddler NEW

Add a burst of flavor to hand-crafted cocktails with our durable dishwasher-safe plastic muddler. Featuring a clever dual-sided design: the round side is perfect for softer muddling while the flat edge is ideal for tougher ingredients.

MPS10 10" L (25.4 cm)



NEW

MPS10



Stainless Steel Tapered Liquor Pourers

Designed to match our supremely stylish bar tools, these tapered pourers add a touch of class to standard-sized liquor bottles. Dishwasher-safe. **Sold in a pack of 12.**

| | |
|-------------|--|
| TPRS | Silver 1 ¼" Dia. x 4 ½" L (3.2 x 11.4 cm) |
| TPRB | Black 1 ¼" Dia. x 4 ½" L (3.2 x 11.4 cm) |
| TPRG | Gold 1 ¼" Dia. x 4 ½" L (3.2 x 11.4 cm) |

Japanese-Style Stainless Steel Jiggers

Upgrade your bar measuring tools with these dishwasher-safe Japanese-Style Jiggers. Available in a variety of dishwasher-safe sleek trendy finishes, each jigger features two different measuring capacities to craft the finest cocktails.

| | |
|-------------|--|
| JG4 | Silver 1 oz. x 1 ½ oz. (29.6 x 44.4 mL) |
| JG5 | Silver 1 oz. x 2 oz. (29.6 x 59.1 mL) |
| JGB4 | Black 1 oz. x 1 ½ oz. (29.6 x 44.4 mL) |
| JGB5 | Black 1 oz. x 2 oz. (29.6 x 59.1 mL) |
| JGG4 | Gold 1 oz. x 1 ½ oz. (29.6 x 44.4 mL) |
| JGG5 | Gold 1 oz. x 2 oz. (29.6 x 59.1 mL) |



Stainless Steel Bar Spoons

A must-have for anywhere mixology is practiced, these sleek and simple weighted-handled spoons look great and make crafting cocktails a cinch. In your choice of finish. Dishwasher-safe.

BSS12 Silver
12" L (30.5 cm)

BSB12 Black
12" L (30.5 cm)

BSG12 Gold
12" L (30.5 cm)

Bar Spoon/Strainer

Mix up popular cocktails while straining out ice and other ingredients with this two-in-one spoon and strainer. Made of durable stainless steel, this tool is a popular mainstay for any of today's mixologists.

BSST12 12" L (30.5 cm)



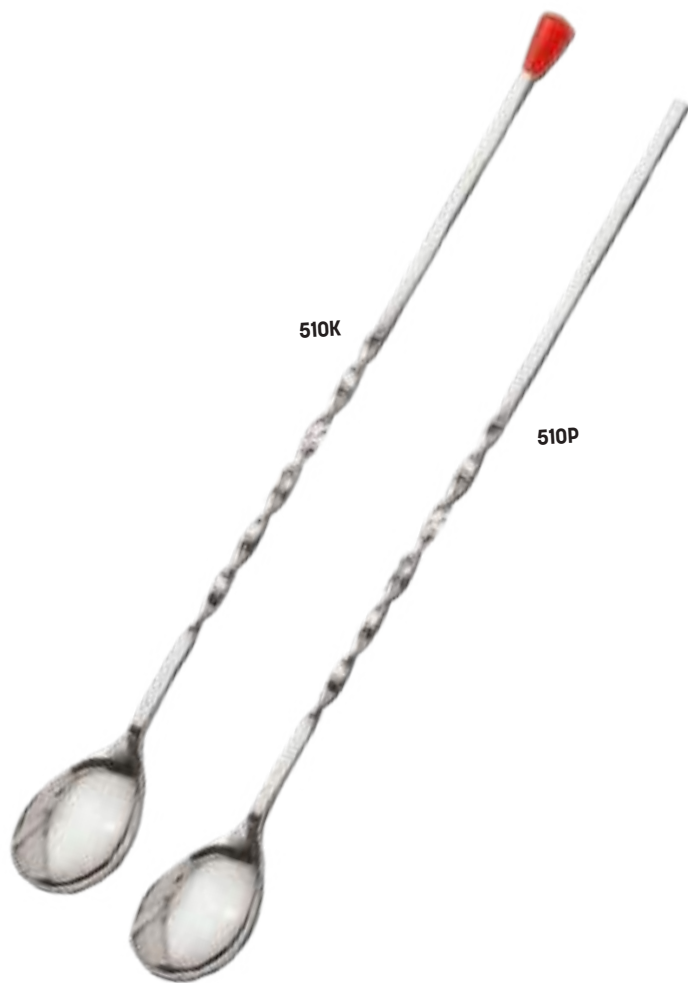

Twisted Bar Spoons

Polished stainless steel with twisted shanks for appearance and durability.

- 510P** No Knob
10" L (25.4 cm)
- 511P** No Knob
11" L (27.9 cm)
(not shown)
- 510K** Red Knob
10" L (25.4 cm)
- 511K** Red Knob
11" L (27.9 cm)
(not shown)
- 512K** Red Knob
12" L (30.5 cm)
(not shown)

Ice Scoops

Easily measure up ice for drinks and cocktails with these durable ice scoops.

- IS734** Cast Aluminum Scoop
 ¼ cup (59.14 mL)
7 ¾" L x 2 ¼" W (19.7 cm x 5.7 cm)
- IS900** Stainless Scoop
½ cup (118.3 mL)
9 ¼" L x 3 ⅜" W (23.5 x 8.6 cm)



Paring Knives

Jazz up your cocktails with beautiful garnishes and tasty zest. Featuring professional-grade blades sharp enough to slice through hard-rind citrus fruit with total ease. Available in your choice of wood or stainless steel easy-grip handles.

- PKW8** Wood Handle Paring Knife
8" L x 1" W, 3 ½" L Blade
(20.3 x 2.5, 8.9 cm)
- PKS8** Stainless Steel Paring Knife
7 ⅞" L x ⅞" W, 3 ½" L Blade
(20 x 2.2, 8.9 cm)



Combination Citrus Squeezer/Bottle Opener

This stainless steel lemon/lime squeezer performs double-duty at the bar.

LSB0 8 1/2" L x 2 1/2" W x 1 1/2" H
(21.6 x 6.4 x 3.8 cm)



Black Finish Squeezer

This heavy-duty metal squeezer with a black lacquered finish features oversized holes for pulp.

LSB3 8 1/2" L x 2 7/8" W x 2 3/8" H
(21.6 x 7.3 x 6 cm)



Bar Strainers

A staple item for every bar, strainers sift out ice and solid ingredients while allowing flavors to mingle in each cocktail. Available in multiple stainless steel options to fit specific crafting requirements. Dishwasher-safe.

JS6 Julep Strainer
6 1/4" L (15.9 cm)

CS8 Mesh Conical Strainer
9 1/4" L (23.5 cm)

S208 2-Prong Strainer
5 1/2" L (14 cm)

S209 4-Prong Strainer
5 3/4" L (14.6 cm)

STC2 2-Prong Tight Coil Strainer
5 3/4" L (14.6 cm)

STC4 4-Prong Tight Coil Strainer
6" L (15.2 cm)



Lemon Lime Peeler

Professional tools ideal for the bar or the kitchen.

106 Peeler/Zester, 6" L (15.2 cm)

Bar Board

White pressed plastic with non-slip ridges. 1/2" (1.3 cm) thick for longer usage.

BB6105 10" L x 6" W x 1/2" H
(25.4 x 15.2 x 1.3 cm)





Top-Shelf™ Waiter's Corkscrews

Choose from a variety of premium stainless steel corkscrews that are as beautiful as they are functional. All are top-shelf choices.

WCRP Red Pear Wood, Two-Stage
4 ¼" L x 1" W x ½" H
(10.8 x 2.5 x 1.3 cm)

WCMA Mahogany Wood, Two-Stage
5 ¼" L x 1 ¼" W x ½" H
(13.3 x 3.2 x 1.3 cm)

Corkscrews

From a portable plastic corkscrew to stainless steel waiter's corkscrews and a deluxe-finished wing corkscrew, we have the perfect tool for every bottle.

CS7545 Pocket Corkscrew
4 ¼" L (10.8 cm)

WCS871 Waiter's Straight Knife
4 ¼" L x 1" W x ¼" H
(10.8 x 2.5 x 0.6 cm)

WCS867 Waiter's Curved Knife
4 ½" L x 7/8" W x 7/8" H
(11.4 x 2.2 x 2.2 cm)

WCSB415 Waiter's Black Plastic
4 ½" L x 1" W x 7/8" H
(11.4 x 2.5 x 2.2 cm)

CS301 Wing Corkscrew
 6 ¼" L x 1 ¾" W
(15.9 x 4.4 cm)

WCS137 Waiter's Stainless Steel
4 ¾" L x 1" W x ¼" H
(11.1 x 2.5 x 0.6 cm)



Stainless Steel Bar Trays and Liners

These bar trays feature a brushed stainless steel lip. Clear mesh liner sold separately.

Trays

SSBT11 11" Dia. (27.9 cm)

SSBT14 14" Dia. (35.6 cm)

Liners

BTTL9 Liner for SSBT11
9 1/4" Dia. (23.5 cm)

BTTL11 Liner for SSBT14
11 3/8" Dia. (29.5 cm)

Double-Wall Hammered Wine Cooler

This stainless steel wine cooler features an elegant hammered design and double-wall insulation to keep bottles colder longer.

DWWC5 54 oz. (1.6 L)
5 3/4" Dia. x 9 5/8" H
(14.6 x 24.4 cm)



CAN ALSO SERVE AS A
SHAREABLE DRINKING VESSEL





Stainless Steel Wine Coolers

Brushed stainless steel coolers are suitable for wine and champagne bottles. Double-wall insulation keeps wine chilled for up to four hours.

SWC48 Straight-Sided
4 3/4" Dia. x 7 5/8" H (12.1 x 19.4 cm)

HGWC1 Hourglass
5 1/4" Dia. x 8" H (13.3 x 20.3 cm)

SLWC2 Angled
5 1/4" Dia. x 9 1/4" H (13.3 x 23.5 cm)

Acrylic Wine Coolers

Double-wall construction provides insulation that keeps chilled wine at proper temperature for up to three hours. Can hold bottles up to 3" (9.52 cm) in diameter.

AWC49 Clear, 5" W x 9" H (12.7 x 23.5 cm)

WCFS462 Silver, 5" W x 9" H (12.7 x 23.5 cm)

Marble Wine Coolers

Coolers keep wine or champagne at proper serving temperature without ice for up to two hours. Color may vary.

MWC57 White, 5" Dia. x 7" H (12.7 x 17.8 cm)

MWC59 Black, 5" Dia. x 7" H (12.7 x 17.8 cm)

Wine Coasters

Choose from a shiny hammered design or a brushed satin finish on these double-wall coasters. Each performs double duty as great little snack servers too.

Silver

SW4 4 3/4" Dia. x 2 1/2" H (12.1 x 6.4 cm)

DWBH4 4 3/4" Dia. x 2 1/2" H (12.1 x 6.4 cm)

Gold

GW4 4 3/4" Dia. x 2 1/2" H (12.1 x 6.4 cm)

GHW4 4 3/4" Dia. x 2 1/2" H (12.1 x 6.4 cm)



Silver-Thread Champagne Bucket and Wine Cooler

So understated and elegant, this double-wall champagne bucket and wine cooler feature brushed stainless steel finishes with polished and etched bases.

SDWW5 Wine Cooler
5 1/2" Dia. x 8 1/4" H (13.3 x 21 cm)

SDWC7 Champagne Bucket
8" Dia. x 8 5/8" H (20.3 x 21.9 cm)



Gold Champagne Bucket and Wine Cooler NEW

Elegantly crafted to celebrate in style, our double-wall champagne bucket and wine cooler are brushed in a timeless gold finish.

GDWW5 Wine Cooler
5 1/2" Dia. x 8 1/4" H (13.3 x 21 cm)

GDWC7 Champagne Bucket
8" Dia. x 8 5/8" H (20.3 x 21.9 cm)



Hammered Wine Buckets and Coolers

Choose from classic stainless steel or copper-plated stainless steel.

Stainless Steel

HMWC75 Wine Cooler
4 3/4" Dia. x 7 1/4" H (12.1 x 18.4 cm)

WB9 Champagne Bucket
9 3/8" L x 8" W x 8 3/8" H (23.8 x 20.3 x 21.3 cm)

Copper-Plated NEW

SW4C Wine Cooler
4 3/4" Dia. x 7 1/4" H (12.1 x 18.4 cm)

WB8C Champagne Bucket
9 3/8" L x 8" W x 8 3/8" H (23.8 x 20.3 x 21.3 cm)



NO TWO ARE ALIKE



SWSC



SWB, SWBSTND
sold separately

Swirl Wine Cooler

Featuring the same design as the Swirl Wine Bucket, this chiller adds an air of sophistication.

SWSC 4 1/2" Dia. x 7 1/4" H (11.4 x 18.4 cm)

Swirl Wine Bucket and Stand

The embossed swirl design on this double-wall bucket fits seamlessly into the most sophisticated settings.

SWB Champagne Bucket
5 qt. (4.7 L)
8 3/4" Dia. x 8 5/8" H (22.9 x 21.9 cm)

SWBSTND Stand
6 1/4" Dia. x 24" H (15.9 x 61 cm)

Hammered Wine Bucket and Stand

This beautiful double-wall stainless steel wine bucket is a knockout on its own. Pair it with the matching stand for a tall, slender floor presentation.

HMWB Champagne Bucket
5 qt. (4.7 L)
8 3/4" Dia. x 8 5/8" H (22.9 x 21.9 cm)

HMWBSTND Stand
6 1/8" Dia. x 24" H (15.6 x 61 cm)

Oval Wine Bucket Stand

This hammered stainless steel bucket fits two wine or champagne bottles. Use the bucket on a tabletop or pair it with the stand for a perfect fit.

O2BWB 2-Bottle Wine Bucket
7 qt. (6.6 L)
8 3/8" L x 10 5/8" W x 9" H
(21.3 x 27 x 22.9 cm)

OWBS Stand
24 1/4" H (61.6 cm)



O2BWB
bucket

OWBS
stand

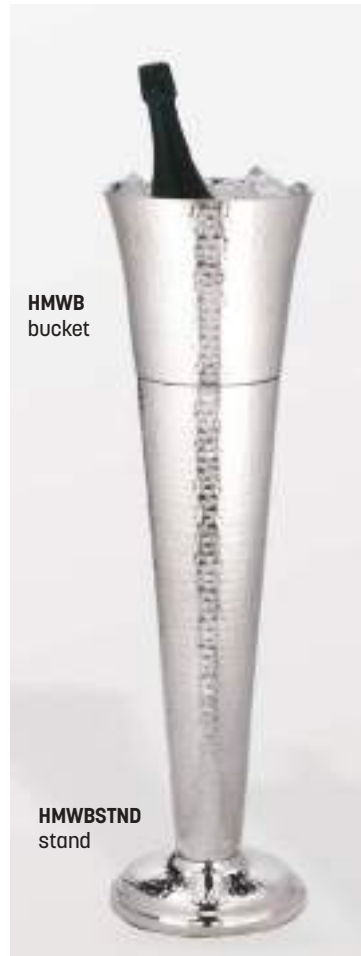

HMWB
bucket

HMWBSTND
stand

Beverage Tub Stands

Our Hammered Double-Wall Party Tubs are impressive on their own. Elevate them with these stands and you'll have a serious showpiece on your hands. Each size features a wide foot for extra stability.

- BTS12** Holds DWBT15
12 1/4" Dia. x 23 5/8" H (31.1 x 60 cm)
- BTS16** Holds DWBT185
16" Dia. x 25" H (40.6 x 63.5 cm)

Champagne Service

Choose from our hammered stainless steel wine bucket or our stainless steel champagne bucket and pair it with one of three stands.

- CHB32** Champagne Bucket Only
8 qt. (7.6 L)
8 3/4" Dia. x 10 1/2" H (22.2 x 26.7 cm)
- CS31** Champagne Stand Only
28" H (71.1 cm)
- CBS33** Champagne Bucket and Stand
8 qt. (7.6 L)
8 3/4" Dia. x 10 1/2" H Bucket
30 1/2" H (77.5 cm) with Stand
(22.2 x 26.7 cm)
- WB9** Hammered Stainless Steel Bucket
5 qt. (4.7 L)
8" Dia. x 8 1/2" H (20.3 x 21.6 cm)
- WICS34** Ironworks Stand
8" Dia. x 32 1/4" H (20.3 x 81.9 cm)
- WBS24** Stand
6 3/8" Dia. x 23 1/2" H (16.2 x 59.7 cm)



Martini Wine Stand

Bottle service goes meta with this clever stainless steel creation. It's also a dramatic way to serve chilled appetizers or desserts.

- WBSM42** 9 qt. (8.5 L)
14 3/4" Dia. x 31 1/2" H x 8 1/2" Deep
(37.5 x 80 x 21.6 cm)





Hammered Aluminum Beverage Tubs and Trays

Add a bit of charm to any occasion from your next brunch buffet to a private table service for two. Available in a variety of sizes, our Hammered Aluminum Beverage Tubs and Trays come in multiple beautiful finishes for a striking look wherever they're placed.

Copper

- ATHC16** Tray, 16" Dia. x 2 ¾" H
(40.6 x 7 cm)
- ATHC9** Tub, 7 ¾ qt. (7.3 L)
12 ¼" L x 9" W x 8 ¾" H
(31.1 x 22.9 x 22.2 cm)
- ATHC10** Tub, 10 qt. (9.4 L)
15" L x 10 ¾" W x 7 ¼" H
(38.1 x 27.3 x 18.4 cm)
- ATHC14** Tub, 16 ¼ qt. (15.3 L)
19" L x 14" W x 8 ¼" H
(48.3 x 35.6 x 21 cm)

Gold

- ATHG16** Tray, 16" Dia. x 2 ¾" H
(40.6 x 7 cm)
- ATHG9** Tub, 7 ¾ qt. (7.3 L)
12 ¼" L x 9" W x 8 ¾" H
(31.1 x 22.9 x 22.2 cm)
- ATHG10** Tub, 10 qt. (9.4 L)
15" L x 10 ¾" W x 7 ¼" H
(38.1 x 27.3 x 18.4 cm)
- ATHG14** Tub, 16 ¼ qt. (15.3 L)
19" L x 14" W x 8 ¼" H
(48.3 x 35.6 x 21 cm)

Silver

- ATHS16** Tray, 16" Dia. x 2 ¾" H
(40.6 x 7 cm)
- ATHS9** Tub, 7 ¾ qt. (7.3 L)
12 ¼" L x 9" W x 8 ¾" H
(31.1 x 22.9 x 22.2 cm)
- ATHS10** Tub, 10 qt. (9.4 L)
15" L x 10 ¾" W x 7 ¼" H
(38.1 x 27.3 x 18.4 cm)
- ATHS14** Tub, 16 ¼ qt. (15.3 L)
19" L x 14" W x 8 ¼" H
(48.3 x 35.6 x 21 cm)

Black

- ATHB16** Tray, 16" Dia. x 2 ¾" H
(40.6 x 7 cm)
- ATHB9** Tub, 7 ¾ qt. (7.3 L)
12 ¼" L x 9" W x 8 ¾" H
(31.1 x 22.9 x 22.2 cm)
- ATHB10** Tub, 10 qt. (9.4 L)
15" L x 10 ¾" W x 7 ¼" H
(38.1 x 27.3 x 18.4 cm)
- ATHB14** Tub, 16 ¼ qt. (15.3 L)
19" L x 14" W x 8 ¼" H
(48.3 x 35.6 x 21 cm)





Square Hammered Tubs

These dishwasher-safe hammered stainless steel tubs are perfect for the most elegant events.

- STH6** 1 3/8 qt. (1.3 L)
6" Sq. x 3 1/4" H
(15.2 x 8.3 cm)
- STH8** 6 1/4 qt. (5.9 L)
8" Sq. x 7 1/4" H
(20.3 x 18.4 cm)
- STH14** 22 1/2 qt. (21.3 L)
14" Sq. x 8 1/2" H
(35.6 x 21.6 cm)
- STH16** 32 1/2 qt. (30.8 L)
16 1/2" Sq. x 9 1/2" H
(41.9 x 24.1 cm)

Angled Hammered Tubs

Available in a variety of versatile sizes, these upscale stainless steel tubs are perfect for table service of wine or beer on ice.

- HMSR6** 2 qt. (1.9 L)
6" Dia. x 7 1/2" H
(15.2 x 43.7 cm)
- HMSR7** 3 qt. (2.8 L)
7" Dia. x 8 1/2" H
(17.8 x 21.6 cm)
- HMSR8** 5 qt. (4.7 L)
8" Dia. x 9 1/2" H
(20.3 x 24.1 cm)



Acacia Marble Melamine Tub NEW

Get the look of acacia wood and marble with the durability of melamine in this trendy, upscale tub.

- JBASEMEL8** 7 1/2 qt. (7.1 L)
11 1/4" Dia. x 7 3/4" H
(28.6 x 19.7 cm)



Party Tubs

Stainless Steel

A dual satin and mirror finish dresses up this tub.

STUB20 25 ¼ qt. (24 L)
20 ½" L x 15" W x 11 ½" H
(51.1 x 38.1 x 28.3 cm)

Galvanized

Hand-wash only. Not for use with acidic foods.

GPTUB20 25 ¼ qt. (24 L)
20 ½" L x 15" W x 11" H
(51.1 x 38.1 x 27.9 cm)

Hammered Party Tub

Manufactured from heavy-duty stainless steel, our big party tub is individually crafted with a ball-peen hammer.

HMDOB19149 25 ¼ qt. (24 L)
19 ½" L x 9" W x 13 ½" H
(49.5 x 22.9 x 34.3 cm)

Double-Wall Party Tubs HOT

These stainless steel tubs feature a mirror finish on the outside with a hammered accent band that runs around the middle. Inside is brushed stainless steel. Free-swinging decorative handles round out the look.

DWBT15 15 qt. (14.2 L)
15" Dia. x 7" H (38.1 x 17.8 cm)

DWBT185 29 qt. (27.4 L)
18 ½" Dia. x 9" H (47 x 22.9 cm)

Punch Bowls

Stainless steel and an elegant profile deliver a one-two punch for large group beverage service.

Hammered

HMPB12 8 qt. (7.6 L)
17" Dia. x 10 ⅞" H
(43.2 x 27.6 cm)

HMPB20 13 qt. (12.3 L)
18 ½" Dia. x 12" H
(47 x 30.5 cm)



CHECK OUT PARTY TUB
STANDS ON PG. 365



HOT

HMPB20

THESE STAINLESS STEEL PUNCH
BOWLS ARE A REAL KNOCKOUT



HMPB12

DWIB40



Top-Shelf Double-Wall Ice Bucket with Ice Tongs

Featuring a high-polished mirror finish, this stainless steel bucket comes with ice tongs and removable grating in the base for drainage.

DWIB40 40 oz. (1.2 L)
5 7/8" Dia. x 7 1/2" H
(14.9 x 19.1 cm)

Satin Finish Double-Wall Ice Buckets with Ice Tongs

These little stainless steel ice buckets come in unique contemporary styles and are perfect for tableside service. Double-wall design keeps ice cooler longer. Features a removable grating in the base to drain water.

ISSB4 34 oz. (1 L)
4 3/8" Dia. x 6 1/4" H
(11.1 x 15.9 cm)

ISSB6 34 oz. (1 L)
4 7/8" Dia. x 6 3/8" H
(12.4 x 16.2 cm)

ISSB4



ISSB4, ISSB6,
DWIB40
ICE BUCKETS
HAVE GRATING
INSIDE



ISSB6



Plastic Condiment Holder

Use this plastic container at the beverage bar, taco bar, omelet station or anywhere else! Features an easy-swing hinged lid and 1 1/2" (3.8 cm) deep storage base for ice.

FCS16 4-Compartment
22 oz. (650.6 mL) each
16" L x 6 1/4" W x 5 1/4" H
(40.6 x 15.9 x 13.3 cm)

Replacement Insert

RC5 22 oz. (650.6 mL) (not shown)
5 3/4" L x 3 5/8" W x 2 3/4" H
(14.6 x 9.2 x 7 cm)

Stainless Steel Condiment Holders

A beautiful stainless steel finish sparkles on these condiment holders. Four, five or six compartments are perfect for keeping all of your garnishes in one place. The sanitary plastic containers fit inside, and a clear, plastic-hinged cover seals in freshness. 16 oz. (473.2 mL) plastic containers.

Hammered Finish

HMCD4 4-Compartment
12" L x 5 3/4" W x 3 1/2" H
(30.5 x 14.6 x 8.9 cm)
(not shown)

HMCD5 5-Compartment
14 3/4" L x 5 3/4" W x 3 1/2" H
(37.5 x 14.6 x 8.9 cm)
(not shown)

HMCD6 6-Compartment
17 3/4" L x 5 3/4" W x 3 1/2" H
(45.1 x 14.6 x 8.9 cm)

Satin Finish

CD4 4-Compartment
12" L x 5 3/4" W x 3 1/2" H
(30.5 x 14.6 x 8.9 cm)
(not shown)

CD5 5-Compartment
14 3/4" L x 5 3/4" W x 3 1/2" H
(37.5 x 14.6 x 8.9 cm)
(not shown)

CD6 6-Compartment
17 3/4" L x 5 3/4" W x 3 1/2" H
(45.1 x 14.6 x 8.9 cm)

Black Finish

CDB4 4-Compartment
12" L x 5 3/4" W x 3 1/2" H
(30.5 x 14.6 x 8.9 cm)
(not shown)

CDB5 5-Compartment
14 3/4" L x 5 3/4" W x 3 1/2" H
(37.5 x 14.6 x 8.9 cm)
(not shown)

CDB6 6-Compartment
17 3/4" L x 5 3/4" W x 3 1/2" H
(45.1 x 14.6 x 8.9 cm)

Replacement Insert

PCI10 Plastic Insert for HMCD4, HMCD5, HMCD6, CD4, CD5, CD6, CDB4, CDB5, CDB6
16 oz. (473.2 mL)



FCS16

KEEPS ALL OF
YOUR GARNISHES COLD



HMCD6

CD6



CDB6



BARB7

BARB5



NEW

BARG7

BARG5

Metal Bar and Coffee Caddies

Colorful bar accessories really “pop” in these metal caddies.

Black

BARB5 8" L x 4" W x 4 1/8" H
(20.3 x 10.2 x 10.5 cm)

BARB7 9 1/8" L x 5 7/8" W x 4 1/8" H
(23.2 x 14.9 x 10.5 cm)

Gold

BARG5 8" L x 4" W x 4" H
(20.3 x 10.2 x 10.2 cm)

BARG7 9 1/8" L x 5 7/8" W x 4 1/8" H
(23.2 x 14.9 x 10.5 cm)

Antique Copper

BARC5 8" L x 4" W x 4 1/8" H
(20.3 x 10.2 x 10.5 cm)

BARC7 9 1/8" L x 5 7/8" W x 4 1/8" H
(23.2 x 14.9 x 10.5 cm)



BARC7

BARC5



HMBAR8

BARS7

Stainless Steel Caddies

BARS7 Satin Finish
 9 1/8" L x 5 7/8" W x 4 1/8" H
 (23.2 x 14.9 x 10.5 cm)

HMBAR8 Hammered Finish
 9 1/8" L x 5 7/8" W x 4 1/8" H
 (23.2 x 14.9 x 10.5 cm)

Plastic Bar Caddy

Black plastic six-compartment organizer.

BAR6 Black
 9 1/2" L x 5 3/4" W x 4 1/8" H
 (24.1 x 14.6 x 10.5 cm)



BAR6

NOT FOR SALE IN
NEW ZEALAND
OR ON MARS
(SERIOUSLY)

LB027

SBO154



BBC39



Bottle and Can Opener

Heavy-gauge tempered stainless steel opener with a hardwood handle.

BBC39 Deluxe Bottle/Can Opener

 4 1/2" L (11.4 cm)

Flat Bottle Openers

Slim, low-profile stainless steel design slips easily into pockets for convenient service.

SBO154 4 1/4" L (10.8 cm)

LB027 7" L (17.8 cm)

Bottle Stoppers

Stop fizz and flavor from escaping with these plastic bottle stoppers. **Sold in a pack of 3.**

EBSS312 Bottle Stoppers

Champagne Bottle Stopper

This stainless steel stopper with high-gloss finish keeps champagne bubbly for up to two days.

CHBST112 Champagne Bottle Stopper

EBSS312



CHBST112





BLACKBM1218 shown with S208 strainer

ALSO AVAILABLE IN BROWN

Service Mat

One-piece rubber construction. 18" L x 12" W (45.7 x 30.5 cm).

BROWNBM1218 Brown (not shown)

BLACKBM1218 Black

Deluxe Bar Mat

One-piece rubber construction. 27" L x 3 1/4" W (68.6 x 8.3).

BM23 Brown

BLM24 Black



BLM24 shown with J205 jigger

BM23

Bar Tile

These 12" square (30.5 cm) molded vinyl tiles snap together. Textured surface prevents slippage, and feet improve drainage and air circulation.

BT12X12 Black

Bar Tray Mat

Round black non-slip mat fits bar trays.

BTTL13 13" Dia. (33 cm)



BTTL13



BT12X12



WARNING: This product can expose you to chemicals including Di(2-ethylhexyl)phthalate (DEHP) & Diisononyl Phthalate (DINP), which are known to the State of California to cause birth defects or other reproductive harm. For more information, go to <http://www.P65warnings.ca.gov>. Warning applies to State of California only.



GR1435

AVAILABLE IN TWO COLORS:
WALNUT AND ESPRESSO



913ST

699ST

524ST

USA

Glass Racks

A wide variety of glasses easily slip in and out of rack ends. Easy to assemble and hang. 35" L x 14" W x 1 1/2" H (88.9 x 35.6 x 3.8 cm).

GR1435 Walnut

RG5341 Espresso
(not shown)

Strainer Funnels

Spun 16-gauge aluminum with a built-in strainer. Makes disposing of accumulated debris easy.

524ST 1 pint (473 mL)
1.25 mm

699ST 1 qt. (946 mL)
1.25 mm

913ST 2 qt. (1.9 L)
1.25 mm

Free-flow funnels are listed on pg. 396.

Kitchen Supplies





DEVELOPS NON-STICK
QUALITIES OVER TIME



SEE PG. 458-459 FOR
PROPER CARE AND USE

Fry Pans

In black or carbon steel, these non-coated fry pans tolerate high heat, making them safe for induction, oven and broiler.

Black Steel

- BSFP8** 7 7/8" Dia. (20 cm)
14 1/4" L (36.2 cm) Overall
- BSFP10** 9 1/2" Dia. (24.1 cm)
17 7/8" L (43.5 cm) Overall
- BSFP11** 11 1/8" Dia. (28.3 cm)
20 1/4" L (51.4 cm) Overall
- BSFP12** 12 1/2" Dia. (31.8 cm)
23 1/4" L (59.1 cm) Overall

Carbon Steel

- CSFP8** 8 1/8" Dia. (20.6 cm)
14 1/2" L (36.8 cm) Overall
- CSFP10** 9 1/2" Dia. (24.8 cm)
17 1/2" L (44.5 cm) Overall
- CSFP11** 11 1/8" Dia. (28.3 cm)
20 1/4" L (51.4 cm) Overall
- CSFP12** 12" Dia. (30.5 cm)
22" L (55.9 cm) Overall

Piano Whips - Sealed

Featuring stainless steel construction, sanitary sealed handles and flexible wire, these are perfect for whisking delicate sauces and batters.

| | |
|-------------|-----------------|
| PW10 | 10" L (25.4 cm) |
| PW12 | 12" L (30.5 cm) |
| PW14 | 14" L (35.6 cm) |
| PW16 | 16" L (40.6 cm) |
| PW18 | 18" L (45.7 cm) |

One-Piece Ladles

All-purpose stainless steel ladles featuring heavy-gauge construction. Sizes are clearly marked for ease of use.

| | |
|---------------|---|
| L11005 | ½ oz. (14.8 mL) 11" (27.8 cm) Handle |
| L1101 | 1 oz. (29.6 mL) 10 ½" (26.7 cm) Handle |
| L11015 | 1 ½ oz. (44.4 mL) 10 ¾" (27.3 cm) Handle |
| L1102 | 2 oz. (59.1 mL) 10 ¾" (27.3 cm) Handle |
| L1103 | 3 oz. (88.7 mL) 11 ¾" (29.8 cm) Handle |
| L1104 | 4 oz. (118.3 mL) 14" (35.6 cm) Handle |
| L1105 | 5 oz. (147.8 mL) 12 ½" (31.8 cm) Handle |
| L1106 | 6 oz. (177.4 mL) 12 ¾" (32.4 cm) Handle |
| L1107 | 7 oz. (207 mL) 12 ½" (31.8 cm) Handle |
| L1108 | 8 oz. (236.6 mL) 12 ¾" (31.1 cm) Handle (not shown) |
| L1112 | 12 oz. (354.8 mL) 12 ¾" (32.4 cm) Handle (not shown) |

Two-Piece Syrup Ladles

Stainless steel two-piece welded ladles stand up to sticky syrup, fudge, fruit and gravy.

| | |
|-------------|--|
| L210 | 1 oz. (29.6 mL) 7" (17.8 cm) Handle |
| L215 | 1 ½ oz. (44 mL) 7" (17.8 cm) Handle |
| L220 | 2 oz. (59.1 mL) 7" (17.8 cm) Handle |

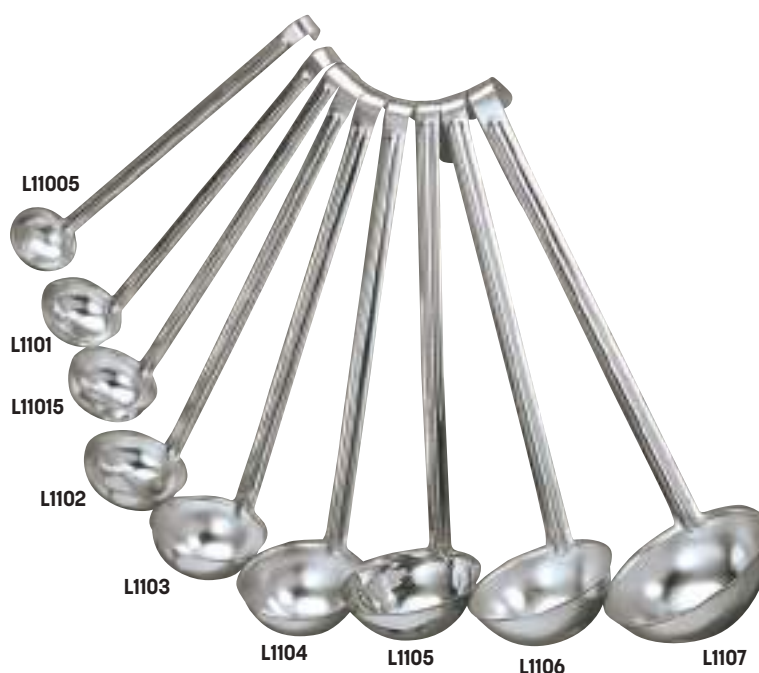
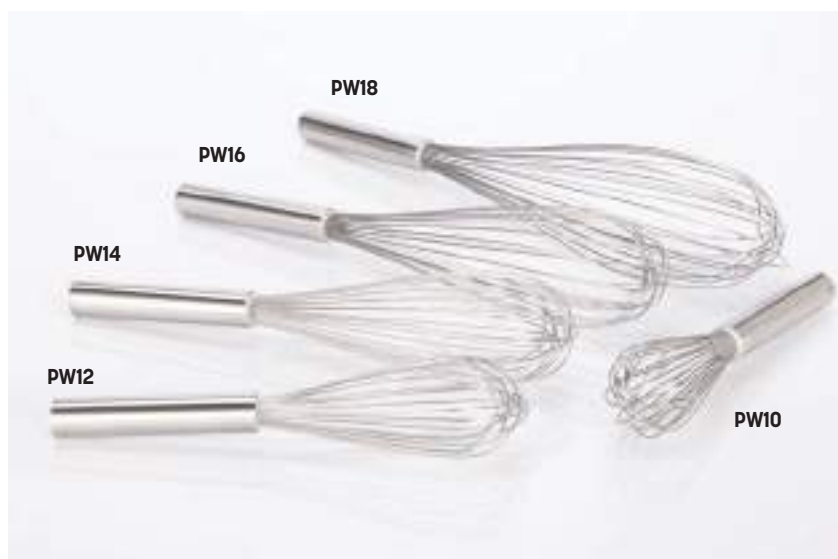



Thumb Dishers

Stainless steel with color-coded poly handles. Scoop number printed on finger guard and bowl sweep. Full-loop release bar.

| | |
|---------------------|---|
| NSPDS6 | White, #6 9" L (22.9 cm) Overall |
| NSPDS8 | Gray, #8 9" L (22.9 cm) Overall |
| NSPDS10 | Ivory, #10 8 5/8" L (21.9 cm) Overall |
| NSPDS12 | Green, #12 8 7/8" L (22.5 cm) Overall |
| NSPDS16 | Blue, #16 8 3/8" L (21.3 cm) Overall |
| NSPDS20 | Yellow, #20 8 3/8" L (21.3 cm) Overall |
| NSPDS24 | Red, #24 8" L (20.3 cm) Overall |
| NSPDS30 | Black, #30 8" L (20.3 cm) Overall |
| NSPDS40 | Orchid, #40 7 1/2" L (19.1 cm) Overall |
| NSPDS SPRING | Replacement Springs |

Ice Cream Spade

Stainless steel spade with a durable black plastic handle for serving even the most frozen ice creams.

| | |
|---------------|---|
| CRM922 | Stainless Steel Blade 3" L x 3 1/2" W (7.6 x 8.9 cm) 9" L (22.9 cm) Overall |
|---------------|---|

THUMB DISHER PORTION CONTROL CHART

| Size | Dia. of Bowl | Fluid Capacity | Patties (lb) | Scoops (qt.) |
|------|--------------------|--------------------|--------------|--------------|
| ○ 6 | 3" (7.62 cm) | 5 oz. (147.9 mL) | 1 | 6 |
| ● 8 | 2 3/4" (6.99 cm) | 4 oz. (118.3 mL) | 3 | 8 |
| ● 10 | 2 5/8" (6.67 cm) | 3.20 oz. (94.6 mL) | 4 | 10 |
| ● 12 | 2 1/2" (6.35 cm) | 2.66 oz. (78.7 mL) | 5 | 12 |
| ● 16 | 2 1/4" (5.72 cm) | 2 oz. (59.1 mL) | 6-8 | 16 |
| ● 20 | 2 1/6" (5.24 cm) | 1.60 oz. (47.3 mL) | 9-10 | 20 |
| ● 24 | 1 29/32" (4.84 cm) | 1.30 oz. (38.4 mL) | 11-12 | 24 |
| ● 30 | 1 3/4" (4.45 cm) | 1.05 oz. (31 mL) | 13-14 | 30 |
| ● 40 | 1 5/8" (4.13 cm) | 0.81 oz. (24 mL) | 15-16 | 40 |



CRM922

Bakelite Handle Spoons

Stainless steel spoons with Bakelite handles.
Available in three differently styled bowls.
13" L (33 cm) overall.

- 132SL** Slotted Bowl
130SO Solid Bowl
131PE Perforated Bowl

Spooners

One-piece stainless steel construction.
Choose between solid and perforated
bowls. Featuring color-coded Bakelite
10 3/4" (27.3 cm) grip handles.

Solid Bowl

- SPN2** Red
2 oz. (59.1 mL)
2 1/2" Dia. (6.4 cm)
- SPN3** Beige
3 oz. (88.7 mL)
3" Dia. (7.6 cm)
- SPN4** Green
4 oz. (118.3 mL)
3 3/8" Dia. (8.6 cm)
- SPN5** Yellow
5 oz. (147.8 mL)
3 1/2" Dia. (8.9 cm)
- SPN6** Black
6 oz. (177.4 mL)
3 3/4" Dia. (9.5 cm)
- SPN8** Blue
8 oz. (236.6 mL)
4" Dia. (10.2 cm)

Perforated Bowl

- SPNP2** Red
2 oz. (59.1 mL)
2 1/2" Dia. (6.4 cm)
- SPNP3** Beige
3 oz. (88.7 mL)
3" Dia. (7.6 cm)
- SPNP4** Green
4 oz. (118.3 mL)
3 3/8" Dia. (8.6 cm)
- SPNP5** Yellow
5 oz. (147.8 mL)
3 1/2" Dia. (8.9 cm)
- SPNP6** Black
6 oz. (177.4 mL)
3 3/4" Dia. (9.5 cm)
- SPNP8** Blue
8 oz. (236.6 mL)
4" Dia. (10.2 cm)



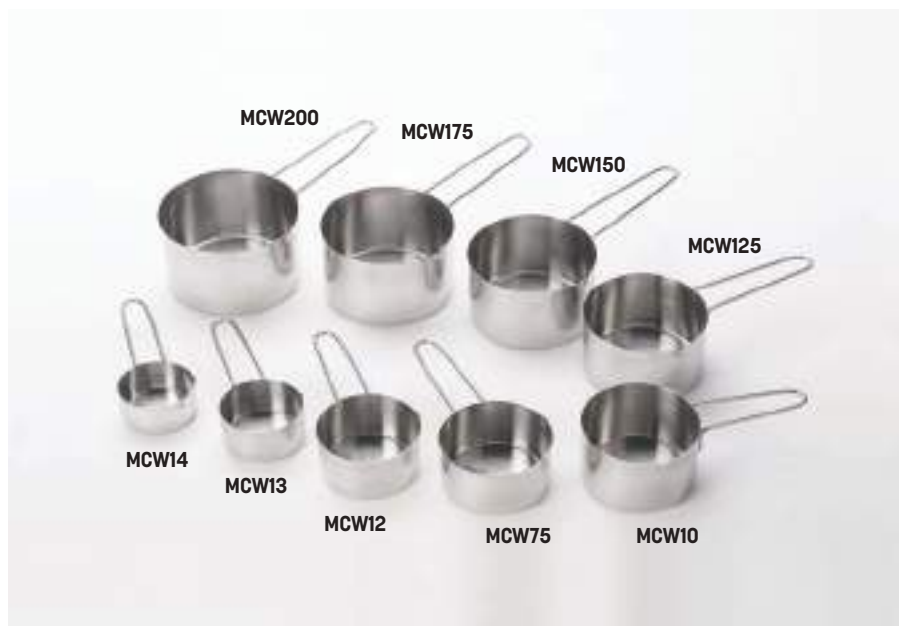

Wire-Handled Measuring Cups

Long-Handled

These stainless steel measuring cups feature extra-long handles to minimize hand-to-food contact. Sold individually.

| | |
|---------------|--|
| MCL14 | ¼-Cup (59.1 mL) 8 ⅞" L (20.6 cm) Overall |
| MCL13 | ⅓-Cup (78.9 mL) 8 ½" L (21.6 cm) Overall |
| MCL12 | ½-Cup (118.3 mL) 8 ⅞" L (22.5 cm) Overall |
| MCL75 | ¾-Cup (177.4 mL) 9 ¼" L (23.5 cm) Overall |
| MCL10 | 1 Cup (236.6 mL) 9 ⅞" L (23.2 cm) Overall |
| MCL125 | 1 ¼-Cup (295.7 mL) 9 ¾" L (24.8 cm) Overall |
| MCL150 | 1 ½-Cup (354.9 mL) 9 ⅝" L (24.4 cm) Overall |
| MCL175 | 1 ¾-Cup (414 mL) 10" L (25.4 cm) Overall |
| MCL200 | 2 Cup (473.2 mL) 10 ¼" L (26 cm) Overall |

Short-Handled

| | |
|---------------|--|
| MCW4 | Set of 4 ¼-Cup (59.1 mL), ⅓-Cup (78.9 mL), ½-Cup (118.3 mL) and 1 Cup (236.6 mL) |
| MCW14 | ¼-Cup (59.1 mL) 5 ⅞" L (13.7 cm) Overall |
| MCW13 | ⅓-Cup (78.9 mL) 5 ⅝" L (14.3 cm) Overall |
| MCW12 | ½-Cup (118.3 mL) 5 ⅞" L (14.9 cm) Overall |
| MCW75 | ¾-Cup (177.4 mL) 6 ⅞" L (15.6 cm) Overall |
| MCW10 | 1 Cup (236.6 mL) 6 ½" L (16.5 cm) Overall |
| MCW125 | 1 ¼-Cup (295.7 mL) 7 ¼" L (18.4 cm) Overall |
| MCW150 | 1 ½-Cup (354.9 mL) 7 ½" L (19.1 cm) Overall |
| MCW175 | 1 ¾-Cup (414 mL) 8 ⅞" L (20.6 cm) Overall |
| MCW200 | 2 Cup (473.2 mL) 8 ⅞" L (21.6 cm) Overall |

Flat-Handled Measuring Cup Set

| | |
|-------------|--|
| MCL4 | Set of 4 ¼-Cup (59.1 mL), ⅓-Cup (78.9 mL), ½-Cup (118.3 mL) and 1 Cup (236.6 mL) |
|-------------|--|

Stainless Steel Measuring Spoon Sets

Different designs available in sets of four different capacities held together by O-rings

MSSS73 1 Tablespoon (14.8 mL), 1 Teaspoon (4.9 mL),
½ Teaspoon (2.5 mL), ¼ Teaspoon (1.2 mL)

MSSR74 1 Tablespoon (14.8 mL), 1 Teaspoon (4.9 mL),
½ Teaspoon (2.5 mL), ¼ Teaspoon (1.2 mL)

MSSF75 1 Tablespoon (14.8 mL), ½ Tablespoon (7.4 mL),
1 Teaspoon (4.9 mL), ½ Teaspoon (2.5 mL)



Dredge

Made of durable plastic, this transparent dredge is dishwasher-safe, as well as stain and odor-resistant. Holds 10 oz. (295 mL). Each unit is shipped with a coarse, medium and fine lid.

10SD Dredge with 3 Tops
4" L x 3" W x 3 ¾" H
(10.2 x 7.6 x 9.5 cm)

Replacement Dredge Lids

T10SDC Coarse Top
3 ½" Dia. x ¾" H
(7.9 x 0.9 cm)

T10SDM Medium Top
3 ½" Dia. x ¾" H
(7.9 x 0.9 cm)

T10SDF Fine Top
3 ½" Dia. x ¾" H
(7.9 x 0.9 cm)



Hand-Crank Cheese Graters

Choose between two easy-to-use graters. The plastic model comes with interchangeable stainless steel cylinders for thin strips, medium grating or fine grating. The stylish stainless steel model comes with one cylinder.

PCG9 Plastic
7 ¾" L x 2 ½" W x 3 ½" H
(19.7 x 6.7 x 8.9 cm)

SCG8 Stainless Steel
8 ⅝" L x 3 ⅝" W x 2 ⅞" H
(21.9 x 9.2 x 7.3 cm)



China Cap Strainers

Heavy-gauge stainless steel with permanently welded handle, band and clip. Comes in your choice of cone and perforation sizes.

Fine - ⅛" (1.59 mm) Perforations

CC10F 10" ID x 10" D x 20" L
(25.4 x 25.4 x 50.8 cm)

CC12F 12" ID x 12" D x 22" L
(30.5 x 30.5 x 55.9 cm)

Coarse - ⅜" (2.38 mm) Perforations

CC10C 10" ID x 10" D x 20" L
(25.4 x 25.4 x 50.8 cm)

CC12C 12" ID x 12" D x 22" L
(30.5 x 30.5 x 55.9 cm)





French Fry Scoops

Choose between right-handed or ambidextrous use. Crafted from stainless steel with plastic handles to protect hands from heat.

- FFSR1** Right Handle
9" L x 8 1/2" W x 2 1/2" H
(22.9 x 21.6 x 6.4 cm)
- FFSD3** Dual Handle
9" L x 8 1/2" W x 2 1/2" H
(22.9 x 21.6 x 6.4 cm)
- FFHANDLE** Replacement Handle
4 1/4" L x 1 1/8" W x 1" H
(10.8 x 2.9 x 2.5 cm)

Aluminum Scoops

Heavy-duty all-purpose scoops crafted from brightly finished cast aluminum with easy-grip handles.

- ASC5** 5 oz. (147.9 mL)
4 3/4" L x 2 3/8" W Bowl
7 1/4" L with Handle
(12.1 x 6, 18.4 cm)
- ASC12** 12 oz. (354.8 mL)
5 7/8" L x 3 1/4" W Bowl
8 1/2" L with Handle
(14.9 x 8.3, 21.6 cm)
- ASC24** 24 oz. (709.7 mL)
7" L x 4" W Bowl
10 1/4" L with Handle
(17.8 x 10.2, 26 cm)
- ASC38** 38 oz. (1.12 L)
8 5/8" L x 4 7/8" W Bowl
11 7/8" L with Handle
(21.9 x 12.4, 30.2 cm)
- ASC58** 8 oz. (1.72 L)
10 1/4" L x 5 1/4" W Bowl
14" L with Handle
(26 x 13.3, 35.6 cm)
- ASC84** 84 oz. (2.49 L)
11 3/8" L x 6 1/2" W Bowl
15 3/4" L with Handle
(28.9 x 16.5, 40 cm)



Polycarbonate Scoops

Scoop ice and other bulk ingredients with these clear, polycarbonate measures specifically designed to handle the rigors of foodservice. Made of durable and dishwasher-safe polycarbonate with easy-to-grip handles, these scoops will surely make measuring easy. Available in multiple capacities.

- PCSC6** 6 oz. (177.4 mL)
10 1/2" L x 2 3/8" W Bowl
(26.7 x 6 cm)
- PCSC12** 12 oz. (354.9 mL)
11 3/8" L x 2 7/8" W Bowl
(28.9 x 7.3 cm)
- PCSC24** 24 oz. (709.8 mL)
12 3/8" L x 4" W Bowl
(31.4 x 10.2 cm)

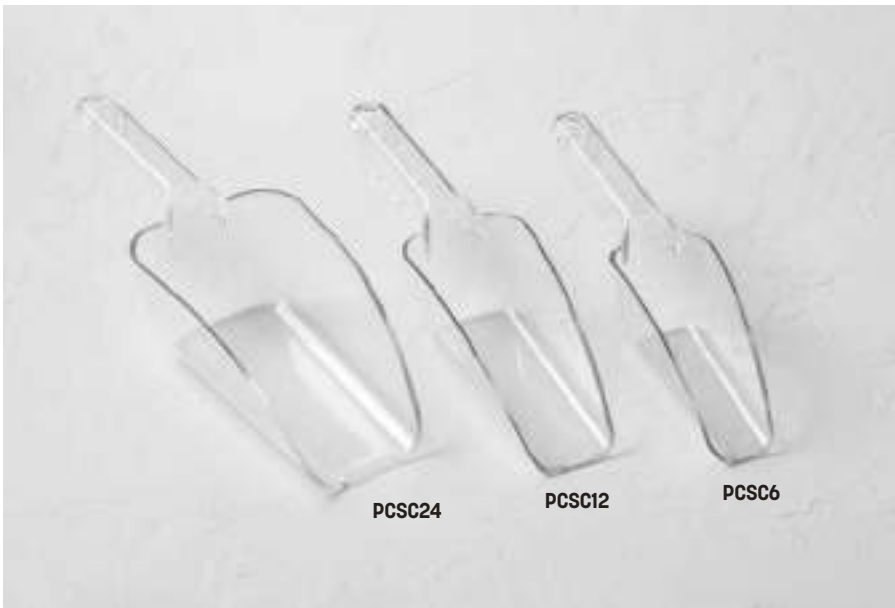

 **WARNING:** This product can expose you to chemicals including Bisphenol A (BPA), which is known to the State of California to cause birth defects or other reproductive harm. For more information, go to www.P65warnings.ca.gov. Warning applies to State of California only.

Bowl Scraper/Dough Scraper/ Cake Decorator

A versatile tool made from durable hard plastic. $\frac{1}{4}$ " hole (6 mm).

BS64 5 $\frac{5}{8}$ " L x 3 $\frac{3}{4}$ " W (14.3 x 9.5 cm)

Slant-Edge Scrapers

Stainless steel blades with slanted edges and beautiful wooden handles.

SSC17 3" W (7.6 cm) Blade
7 $\frac{1}{2}$ " L (19.1 cm) Overall

SSC19 4" W (10.2 cm) Blade
8 $\frac{1}{4}$ " L (21 cm) Overall

SSC18 3" W (7.6 cm) Blade
12" L (30.5 cm) Overall



Heat-Resistant Scrapers

Long cool-touch handles and stain-resistant blades add up to smart, safe kitchen work. Dishwasher-safe and heat resistant up to 500° F (260° C).

PHBS10 2 $\frac{1}{8}$ " W (5.4 cm) Blade
10 $\frac{1}{2}$ " L (26.7 cm) Overall

PHBS14 2 $\frac{3}{4}$ " W (7 cm) Blade
14" L (35.6 cm) Overall

PHBS16 2 $\frac{3}{4}$ " W (7 cm) Blade
16 $\frac{1}{4}$ " L (41.3 cm) Overall



Dough Cutters and Scrapers

Rounded corners will not scratch or damage trays.

DS6704 Wood-Handled
4 $\frac{1}{2}$ " L (11.4 cm)

DSP6705 Plastic-Handled
4 $\frac{1}{2}$ " L (11.4 cm)

DS6706 Wood-Handled
6" L (15.2 cm)

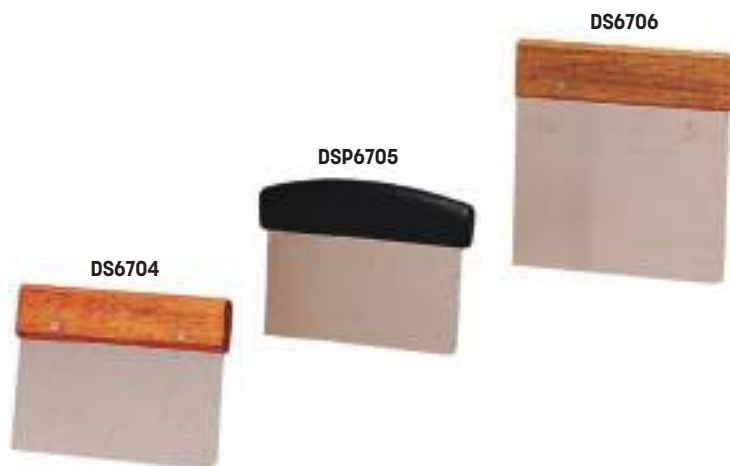



Wood-Handled Turners

Stainless steel offset blades and wood handles. Available with straight or rounded edges.

Giant "Oversize" Turners

- LT20** 8" L x 3" W Blade, 20" L Overall (20.3 x 7.6, 50.8 cm)
- 19008** 8" L x 4" W Blade, 15 3/4" L Overall (20.3 x 10.2, 40 cm)
- LT198** 8" L x 4" W Blade, 20" L Overall (20.3 x 10.2, 50.8 cm)

14" (35.6 cm) Long Overall with 8" Blade

- LT14** Rounded Blade
8" L x 3" W (20.3 x 7.6 cm)
- LT14ST** Straight Blade
8" L x 3" W (20.3 x 7.6 cm)
- LT14P** Rounded Perf Blade
8" L x 3" W (20.3 x 7.6 cm)

12" (30.5 cm) Long Overall with 6" Blade

- LT12** Rounded Blade
6" L x 3" W (15.2 x 7.6 cm)
- LT12ST** Straight Blade
6" L x 3" W (15.2 x 7.6 cm)

Plastic-Handled Turners

Stainless steel offset blades and dark brown plastic handles. Available with straight or rounded edges.

14" (35.6 cm) Long Overall with 8" Blade

- PS14** Rounded Blade
8" L x 3" W (20.3 x 7.6 cm)
- PS14P** Rounded Perf Blade
8" L x 3" W (20.3 x 7.6 cm)

12" (30.5 cm) Long Overall with 6" Blade

- PS12ST** Straight Blade
6" L x 3" W (15.2 x 7.6 cm)
- PS12** Rounded Blade
6" L x 3" W (15.2 x 7.6 cm)

Pressed Wood Servers

Made of pressed wood fiber, these dishwasher-safe serving utensils offer affordable convenience to any operation.

- MPS12** Spatula
12" L (30.5 cm)
- MPT12** Turner
12" L (30.5 cm)



Wood-Handled Hamburger Turners / Pizza Servers

Stainless steel offset blades with straight edges.

19007 5" L x 3" W Blade
11 5/8" L Overall
(12.7 x 7.6, 29.5 cm)

19075 6" L x 4" W Blade
11 5/8" L Overall
(15.2 x 10.2, 29.5 cm)

Heavy-Duty Hamburger Turners / Pizza Servers

Stainless steel offset blades and black plastic handles. Available with straight or rounded edges.

PS197 5" L x 3" W Blade
11 5/8" L Overall
(12.7 x 7.6, 29.5 cm)

PS19075 6" L x 4" W Blade
11 5/8" L Overall
(15.2 x 10.2, 29.5 cm)



19007

19075

PS197

PS19075

PS19008

Giant "Oversize" Turner

PS19008 8" L x 4" W Blade
15 3/4" L Overall
(20.3 x 10.2, 40 cm)

Assorted Servers

Plastic-Handled Turner

Stainless steel offset blade with rounded edges.

PS10 3 5/8" L x 1 7/8" W Blade
10" L Overall
(9.2 x 4.8, 25.4 cm)

Wood-Handled Pie Server/Pizza Server

Stainless steel with a flexible tapered offset blade.

19006 5" L x 2 1/2 - 1 1/2" W Blade
10 1/2" L Overall
(12.7 x 6.3 - 3.8, 26.7 cm)

Slotted Fish Spatula

A specially shaped stainless steel blade and polypropylene handle make this an essential for anyone who serves fish.

PSFSP 6 1/2" L x 2 7/8" W Blade
11 3/4" L Overall
(16.5 x 7.3, 29.8 cm)

Pie Server/Pizza Server

Stainless steel with a flexible tapered offset blade and dark brown plastic handle.

PS196 5" L x 2 1/2 - 1 1/2" W Blade
10 1/2" L Overall
(12.7 x 6.3 - 3.8, 26.7 cm)

Deluxe Stainless Steel Server

Straight out of our Buffet & Display section, this beautiful server features a sleek design that works for the back of the house as well as the front.

SW12PAS 11" L Server (27.9 cm)



PS10

19006

PSFSP

PS196

SW12PAS



Utility Tongs

Heavy-Weight (not shown)

0.7 mm stainless steel with tempered flat steel springs.

- UT707** 7" L (17.8 cm)
- UT975** 10" L (25.4 cm)
- UT1200** 12" L (30.5 cm)
- UT1600** 16" L (40.6 cm)
- FS911** Replacement Spring

Extra-Heavy Weight

1.2 mm stainless steel with tempered flat steel springs.

- HDUT975** 10" L (25.4 cm)
- HDUT1200** 12" L (30.5 cm)
- HDUT1600** 16" L (40.6 cm) w/ Double Flat Spring
- FS911** Replacement Spring

Heavy-Duty Stainless Steel Pastry or Meat Tongs

You will get years of use from these durable multi-use tongs.

- IT878** 9 1/2" L (24.1 cm)

Salad Server/Pastry Tongs

These elegant stainless steel tongs are perfect for serving individual portions.

- SS782** 8" L (20.3 cm)



Square Fine Mesh Skimmers HOT

Nickel-plated and durable with 14" (35.6 cm) handle.

SKS514 5" Sq. (12.7 cm)

SKS714 7" Sq. (17.8 cm)

Round Mesh Culinary Baskets

These classic nickel-plated strainers are 3" (7.6 cm) deep with 9" (22.9 cm) handles.

Fine Mesh

CBF8 8" Dia. (20.3 cm)
(not shown)

CBF9 9" Dia. (22.9 cm)
(not shown)

CBF10 10" Dia. (25.4 cm)
(not shown)

CBF12 12" Dia. (30.5 cm)

Coarse Mesh

CBC8 8" Dia. (20.3 cm)
(not shown)

CBC9 9" Dia. (22.9 cm)
(not shown)

CBC10 10" Dia. (25.4 cm)
(not shown)

CBC12 12" Dia. (30.5 cm)





ISW2

ISW3



AHM485

Steak Weights

Cast iron weights featuring wooden handles. It's hard to improve upon this classic design.

ISW2 8" L x 4" W (20.3 x 10.2 cm)

ISW3 9" L x 5" W (22.9 x 12.7 cm)

Adjustable Burger Mold

Take control of portions with this adjustable mold. Crafted from heavy cast aluminum, this handy tool can press patties up to 3 ½ oz. (103.5 mL).

AHM485 4 ½" Dia. (11.4 cm)



1423

Broiler Brush

With one semi-stiff side and one extra-stiff side, this tempered stainless steel scraper can clean even the most burned-on foods. Handle has metal-threaded tip for extra durability and safety.

1423 31" L x 8 ½" W x 5" H (78.7 x 21.6 x 12.7 cm)



Cedar Planks

Create smoky flavors the classic way. Simply soak the planks in water, add fish, appetizers or veggies and fire up the grill. **Sold in a pack of 12.**

CWP7 6 ½" L x 3 ½" W x ¼" H (16.5 x 8.9 x 0.6 cm)

CWP8 8" L x 5 ½" W x ¼" H (20.3 x 14 x 0.6 cm)

CWP12 11 ⅞" L x 5 ½" W x ¼" H (30.2 x 14 x 0.6 cm)



CWP8

CWP7

CWP12



1347

Wire Brush with Scraper

With tempered steel bristles and a wooden handle.

1347 1 1/8" (2.9 cm) Bristles
14" L x 2 1/2" H (35.6 x 6.4 cm)

Egg Slicer

Made from die-cast aluminum. Makes oval or round slices.

ES474 4 1/4" Dia. x 1 1/4" H (10.8 x 3.2 cm)

Coil-Handle Egg Rings

Heavy chrome plating on half round wire. 3/8" high (0.95 cm) wall.

ER333 3 1/4" Dia. (8.3 cm) Ring
3 5/8" H (9.2 cm) with Handle

ER444 4 3/8" Dia. (11.1 cm) Ring
4 7/8" H (12.4 cm) with Handle

Standard Egg Rings

Rings and handles made from stainless steel. 1" high (2.54 cm) wall to prevent leaks.

ER387 4" Dia. (10.2 cm) Ring
2 3/4" H (7 cm) with Handle

ER487 5" Dia. (12.7 cm) Ring
2 3/4" H (7 cm) with Handle

ER587 6" Dia. (15.2 cm) Ring
2 3/4" H (7 cm) with Handle



Shown with PW14 whisk and MCL10, MCW10 measuring cups



CBL141CL

CBL96SH

CBL54ST

Crave Collection Mixing Bowls BPA FREE

The Crave Collection hits the kitchen with these durable yet delightful mixing bowls. Available in the popular dinnerware colors (Cloud, Shadow and Storm) and complete with the organic texture that has made Crave so popular, these bowls can easily perform double duty as serving bowls.

CBL54ST Storm, 54 oz. (1.6 L)
7 5/8" Dia. x 4 1/8" H
(19.4 x 10.5 cm)

CBL96SH Shadow, 96 oz. (2.8 L)
9 1/4" Dia. x 4 7/8" H
(23.5 x 12.4 cm)

CBL141CL Cloud, 141 oz. (4.2 L)
10 1/2" Dia. x 5 1/2" H
(26.7 x 14 cm)

Stainless Steel Mixing Bowls HOT

In a huge range of ten different sizes, these are the only mixing bowls you'll ever need.

SSB75 21 oz. (621 mL)
6 1/2" Dia. x 2" H
(16.5 x 5.1 cm)

SSB150 36 oz. (1.1 L)
7 7/8" Dia. x 2 1/2" H
(20 x 6.4 cm)

SSB200 55 oz. (1.6 L)
8 1/2" Dia. x 2 3/4" H
(21.6 x 7 cm)

SSB300 76 oz. (2.2 L)
9 7/8" Dia. x 3" H
(25.1 x 7.6 cm)

SSB400 100 oz. (3 L)
10 3/4" Dia. x 3 1/4" H
(27.3 x 8.3 cm)

SSB500 128 oz. (3.8 L)
11 1/2" Dia. x 3 3/4" H
(29.2 x 9.5 cm)

SSB800 179 oz. (5.3 L)
13 1/2" Dia. x 4 1/4" H
(34.3 x 10.8 cm)

SSB1300 354 oz. (10.5 L)
16 1/4" Dia. x 4 7/8" H
(41.3 x 12.4 cm)

SSB1600 512 oz. (15.1 L)
18 1/2" Dia. x 5 3/4" H
(47 x 14.6 cm)

SSB2000 596 oz. (17.6 L)
19" Dia. x 6" H
(48.3 x 15.2 cm)

From top to bottom:

- SSB150
- SSB200
- SSB300
- SSB400
- SSB500
- SSB800
- SSB1300
- SSB1600
- SSB2000



HOT

SSB75

Round Woven Woodenware Bowl 🔥

Traditional material and design add up to a classic style your customers will want to share.

RWW8 26 oz. (0.77 L)
8" Dia. x 2" H
(20.3 x 5.1 cm)



RWW8

Pans and Cutters

Angel Food Cake Pan

Heavy-duty 14-gauge pan. 1.5 mm hard aluminum with satin anodized finish.

AFP958 4 qt. (3.8 L)
10" OD x 4" Deep x 4 1/4" Cone
(25.4 x 10.2 x 10.8 cm)

Doughnut Cutter

One-piece 16-gauge cutter. 1.25 mm satin anodized aluminum.

13001 3" Dia. x 2 1/2" H (7.6 x 6.4 cm)

Biscuit Cutter

One-piece 16-gauge cutter. 1.25 mm satin anodized aluminum.

13005 3" Dia. x 2 1/2" H (7.6 x 6.4 cm)

Stainless Steel Cake Rings

0.036" (0.9 mm) heavy-duty 20-gauge rings ensure uniform treats.

SR6063 6" Dia. X 3" H
(15.2 x 7.6 cm)

SR6073 7" Dia. X 3" H
(17.8 x 7.6 cm) (not shown)

SR6083 8" Dia. X 3" H
(20.3 x 7.6 cm) (not shown)

SR6093 9" Dia. X 3" H
(22.9 x 7.6 cm) (not shown)

SR6103 10" Dia. X 3" H
(22.9 x 7.6 cm) (not shown)

Springform Pan

This carbon steel, non-stick springform pan features a durable buckle and removable bottom for creating impressively shaped cakes.

TSFP10 10 1/4" Dia. x 2 5/8" H
(26 x 6.7 cm)



SR6063



TSFP10

DURABLE BUCKLE



USA

A80012

Straight-Sided Aluminum Cake Pan Sets

Available in 2" and 3" depths and heavy-weight aluminum options, these cake pans provide the needed sizes for your cake creations.

- A80012** 2" Deep 18-ga., 1 mm
Set includes (1) Each 6", 8", 10", 12", 14" and 16" (15.2, 20.3, 25.4, 30.5, 35.6 and 40.6 x 5.1 cm)
- HA80012** 2" Deep 14-ga., 1.5 mm
Set includes (1) Each 6", 8", 10", 12", 14" and 16" (15.2, 20.3, 25.4, 30.5, 35.6 and 40.6 x 5.1 cm) (not shown)
- 3801** 3" Deep 14-ga., 1.5 mm
Set includes (1) Each 6", 8", 10", 12" and 14" (15.2, 20.3, 25.4, 30.5 and 35.6 x 7.6 cm) (not shown)

Round Aluminum Cake Pans

Heavy-weight 14-ga., 1.5 mm aluminum, 3" Deep.

- 3806** 6" ID x 3" Deep (15.2 x 7.6 cm)
- 3807** 7" ID x 3" Deep (17.8 x 7.6 cm)
- 3808** 8" ID x 3" Deep (20.3 x 7.6 cm)
- 3809** 9" ID x 3" Deep (22.9 x 7.6 cm)
- 3810** 10" ID x 3" Deep (25.4 x 7.6 cm)
- 3812** 12" ID x 3" Deep (30.5 x 7.6 cm)
- 3813** 13" ID x 3" Deep (33 x 7.6 cm)
- 3814** 14" ID x 3" Deep (35.6 x 7.6 cm)



STRAIGHT-SIDED EDGES CREATE SMOOTH CAKE EDGES





TAPERED EDGES CREATE THE PERFECT CRUST

HOT USA

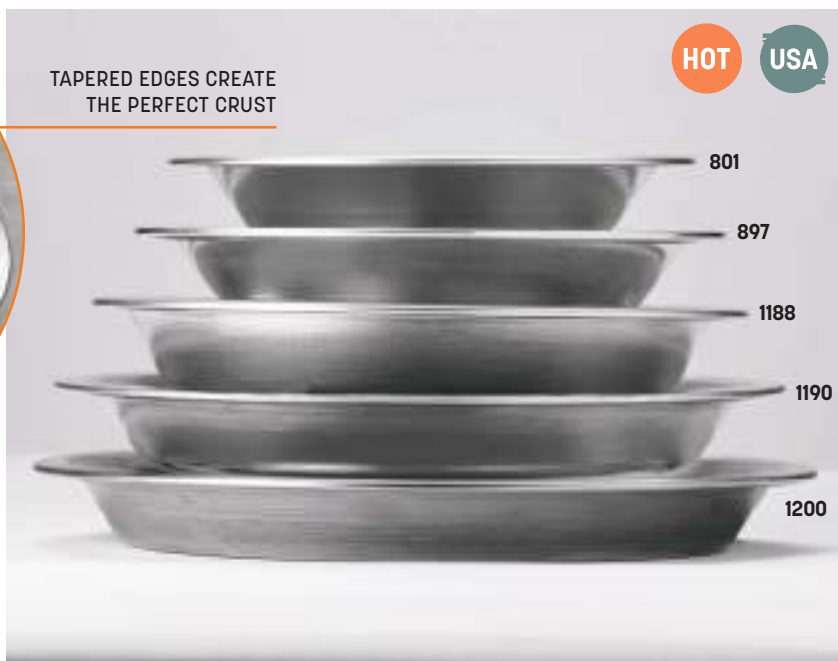

Deep-Dish Aluminum Pie Pans

Standard-weight 18-ga., 1 mm aluminum.

- 801** 7" Top ID x 8" Top OD x 5 1/2" Bottom ID x 1 1/8" Deep (17.8 x 20.3 x 14 x 2.9 cm)
- 897** 8" Top ID x 9" Top OD x 6 1/4" Bottom ID x 1 3/8" Deep (20.3 x 22.9 x 15.9 x 3 cm)
- 1188** 9" Top ID x 10" Top OD x 7 3/4" Bottom ID x 1 1/4" Deep (22.9 x 25.4 x 19.7 x 3.2 cm)
- 998** 9" Top ID x 10 1/8" Top OD x 7 5/8" Bottom ID x 1 1/4" Deep (22.9 x 25.7 x 19.4 x 3.2 cm) (not shown)
- 989** 9 1/8" Top ID x 9 7/8" Top OD x 7 3/8" Bottom ID x 1 1/8" Deep (23.2 x 25.1 x 18.7 x 2.9 cm) (not shown)
- 1190** 10" Top ID x 11 1/8" Top OD x 8 1/4" Bottom ID x 1 5/16" Deep (25.4 x 28.3 x 21 x 3.3 cm)
- 1200** 10 7/8" Top ID x 11 7/8" Top OD x 9 1/8" Bottom ID x 1 1/4" Deep (27.6 x 30.2 x 23.2 x 3.2 cm)

Standard Aluminum Pie Pans

Standard-weight 18-ga., 1 mm aluminum.

- 475** 4" Top ID x 4 3/8" Top OD x 3" Bottom ID x 1" Deep (10.2 x 11.1 x 7.6 x 2.5 cm)
- 744** 6" Top ID x 7" Top OD x 5 1/2" Bottom ID x 5/8" Deep (15.2 x 17.8 x 14 x 1.6 cm)
- 918** 7 7/8" Top ID x 9 1/8" Top OD x 6 7/8" Bottom ID x 1" Deep (20 x 23.2 x 17.5 x 2.5 cm)
- 1187** 9" Top ID x 10 1/8" Top OD x 8 1/8" Bottom ID x 3/4" Deep (22.9 x 25.7 x 20.6 x 1.9 cm)
- 1300** 11 7/8" Top ID x 13" Top OD x 10 7/8" Bottom ID x 7/8" Deep (30.2 x 33 x 27.6 x 2.2 cm)
- 1600** 15" Top ID x 16" Top OD x 13 3/4" Bottom ID x 7/8" Deep (38.1 x 45.6 x 34.9 x 2.2 cm)

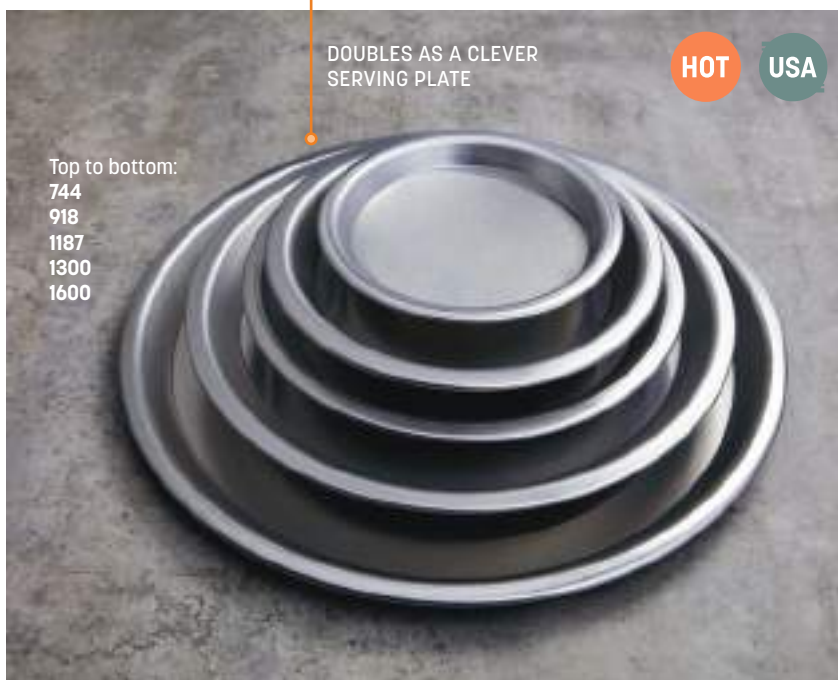

FOR STRAINER FUNNELS, REFER
TO PG. 376 IN BAR SUPPLIES



Spun Aluminum Funnels

One-piece spun aluminum in your choice of sizes and weights.

1 mm, 18-gauge Aluminum

- 363** ½ Pint (236 mL)
3 7/8" Dia. Funnel x 3 5/8" H
x 5/8" Dia. Neck (9.8 x 9.2 x 1.6 cm)
- 524** 1 Pint (473 mL)
5 1/4" Dia. Funnel x 5 1/4" H
x 1 1/16" Dia. Neck (13.3 x 13.3 x 1.8 cm)

1.25 mm, 16-gauge Aluminum

- 699** 1 qt. (0.95 L)
7" Dia. Funnel x 6 5/8" H
x 3/4" Dia. Neck (17.8 x 16.8 x 1.9 cm)
- 913** 2 qt. (1.9 L)
9 1/8" Dia. Funnel x 7 3/4" H
x 1 1/16" Dia. Neck (23.2 x 19.7 x 1.8 cm)

1.5 mm, 14-gauge Aluminum, Heavy-Duty

- 1004** 4 qt. (3.8 L)
8 3/4" Dia. x 8" H
x 3" Dia. Neck (22.2 x 20.3 x 7.6 cm)

Check Spindles

Keep used checks in one spot with these classic, retro spindles featuring your choice of metallic plating.

- GCS37** Brass-Plated
3" Dia. x 6" H (7.6 x 15.2 cm)
- NCS36** Nickel-Plated
3" Dia. x 6" H (7.6 x 15.2 cm)

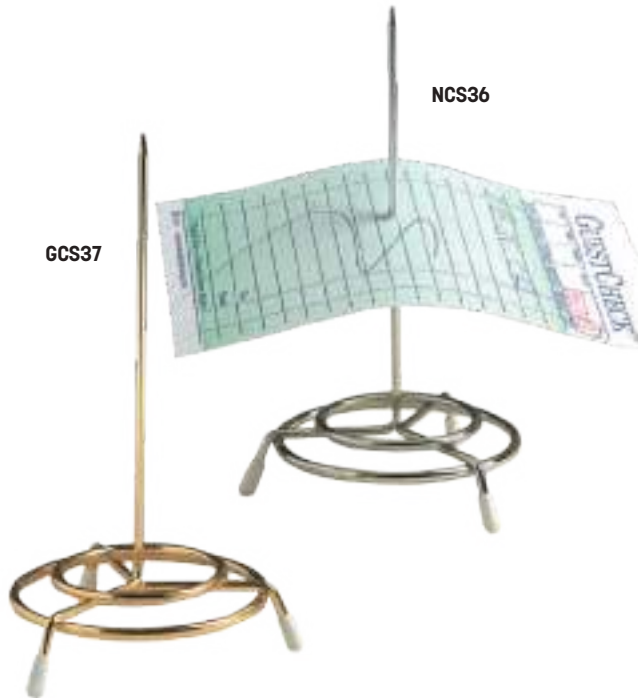

Sandwich Spreader

With a stainless steel blade and wooden handle, this tool is elegantly simple.

- SPR725** 7 3/4" L (19.7 cm)



Call Bell

A real humdinger in nickel-plated stainless steel with a black base.

- CB338** 3 3/8" Dia. (8.6 cm)





Short-Height Stainless Steel Ticket Racks

Specifically engineered for modern restaurant needs, these stainless steel ticket racks are the perfect height for most restaurant spaces.

TRSH12 12" L x 1 1/8" H (30.5 x 2.9 cm)

TRSH18 18" L x 1 1/8" H (45.7 x 2.9 cm)

TRSH24 24" L x 1 1/8" H (61 x 2.9 cm)

Stainless Steel Ticket Racks

Marbles inside the groove keep tickets in place. Plastic end caps with screws hold the marbles in.

TR18 18" L x 3 1/2" H (45.7 x 8.9 cm)

TR24 24" L x 3 1/2" H (61 x 8.9 cm)

TR30 30" L x 3 1/2" H (76.2 x 8.9 cm)

TR36 36" L x 3 1/2" H (91.4 x 8.9 cm)

TR48 48" L x 3 1/2" H (121.9 x 8.9 cm)



Aluminum Ticket Racks

Marbles inside hold tickets securely. Attaches easily to walls and racks.

AOR18 18" L x 2 1/2" H (45.7 x 6.4 cm) (not shown)

AOR24 24" L x 2 1/2" H (61 x 6.4 cm) (not shown)

AOR36 36" L x 2 1/2" H (91.4 x 6.4 cm)

AOR48 48" L x 2 1/2" H (121.9 x 6.4 cm) (not shown)





BA940S

BA1040S

BA840S

BA740S

BA640S

HOT

GRILL OR BASTING COVERS WITH BAKELITE KNOBS

Economical basting covers with black Bakelite knobs. Full 2" (5.1 cm) clearance over grill. Ships unassembled with knobs protected in a polybag.

Round Stainless Steel Basting Covers HOT

BA640S 6 1/2" Dia. x 2" H (16.5 x 5.1 cm)

BA740S 7 1/2" Dia. x 2" H (19.1 x 5.1 cm)

BA840S 8 3/8" Dia. x 2" H (21.3 x 5.1 cm)

BA940S 9 1/4" Dia. x 2" H (23.5 x 5.1 cm)

BA1040S 10 1/2" Dia. x 2 1/8" H (26.7 x 5.4 cm)

BAKNOB Extra Knob
Minimum Order 12 Pieces

Round Aluminum

Basting Covers HOT USA

BA640A 6" Dia. x 2" H (15.3 x 5.1 cm)

BA740A 7" Dia. x 2" H (17.8 x 5.1 cm)

BA840A 8" Dia. x 2" H (20.3 x 5.1 cm)

BA940A 9" Dia. x 2" H (22.9 x 5.1 cm)

BA1040A 10" Dia. x 2" H (25.4 x 5.1 cm)

BAKNOB Extra Knob
Minimum Order 12 Pieces



BA640A

BA740A

BA840A

BA940A

BA1040A

HOT

Square Aluminum Basting Covers USA

BASQ620 6" Sq. x 2" H (15.2 x 5.1 cm)

BASQ820 8" Sq. x 2" H (20.3 x 5.1 cm)

BASQ1020 10" Sq. x 2" H (25.4 x 5.1 cm)

BAKNOB Extra Knob
Minimum Order 12 Pieces



USA

BASQ1020

BASQ820

BASQ620

Pizza Pans & Supplies



A Guide to our Pizza Pans

Aluminum Pans

Aluminum is an excellent conductor of heat, providing evenly baked crusts.

Standard-weight pans (denoted with "A" at the beginning of the item number) are made from 18-ga., 0.040", 1 mm aluminum.

Heavy-weight pans (denoted with "HA" at the beginning of the item number) are made from 14-ga., 0.064", 1.5 mm aluminum and are 50% heavier than standard-weight.

- Hand washing with aluminum-safe detergent is recommended.
- Through repeated use, pans will soften and, if scoured, will thin.



ALUMINUM (A/HA)

Tin Plate Pans

Tin plate is a heavy-weight metal that will darken over time, providing even, efficient cooking.

Tin plate pans (denoted with "T" at the beginning or end of the item number) should be seasoned before use and may need periodic re-seasoning.

- Will darken with use and rust if refrigerated, soaked in water or left unseasoned in damp environments.
- Hand wash and wipe-dry immediately.
- Call for additional tin plate pan options.

How to Season

To season, wash in warm, soapy water and quickly dry. Brush oil on inside and outside surfaces of the pan and bake to a golden or dark brown. When seasoning, bake at regular times and temperatures. Some pans may need a second or third coating before being fully seasoned.

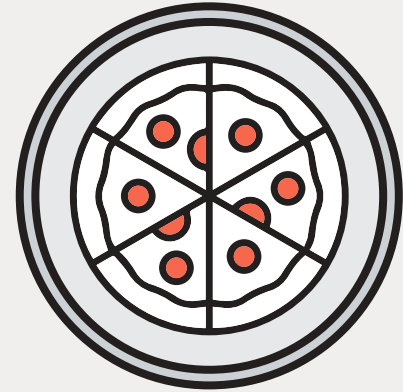

TIN PLATE (T)

Hard Coat Anodized Pans

Heavy-weight and efficient, hard coat aluminum provides quick and efficient results.

Hard coat pans (denoted with "HC" at the beginning or end of the item number) are anodized with a synergistic electro-chemical process that converts the surface of aluminum into a dark aluminum oxide.

- Made from heavy-weight aluminum unless perforated, in which case they're made from standard-weight aluminum.
- Through repeated use, pans will soften and, if scoured, will thin.
- Season before use and hand wash with aluminum-safe detergent.

How to Season

Wash and dry the pan thoroughly. Wipe oil on the inside and outside surfaces of the pan and allow to soak in for 30 minutes. Then bake at regular cooking times and temperatures. Do not overbake and do not wash off excess oil. The oil residue and any additional oil added before baking allows the pan to develop non-stick properties. Remember when cleaning hard anodized aluminum, this is considered an amphoteric coating and will be attacked by solutions of a high-alkaline or acidic nature. Do not expose these pans to dishwashers or caustic cleaning solutions. Hand wash with detergents made specifically for aluminum.

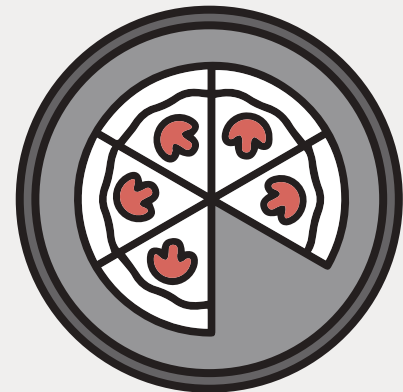

HARD COAT ANODIZED (HC)

USA Proudly Manufactured in the United States of America

For over 75 years American Metalcraft has been producing pizza pans and trays in our facility located right outside of Chicago, Illinois. We are proud to still manufacture American-made quality products by employing local workers. When you see this symbol , rest assured the product is made in America.

We carry thousands of different pizza trays in varying styles, depths, materials and other options, resulting in tens of thousands of possible combinations. Because each pan is made to order, it's possible that yours is the first of its kind. Special-order pans cannot be cancelled or returned, so please review and re-confirm your order. If you have any questions, give us a call and, if necessary, request a sample.

Nibs (N)

minimum
order
24 pieces

Nibs raise the pizza off of the baking surface, allowing moisture to escape providing a fresher, crispier pizza.

- Nibs are approximately $\frac{3}{8}$ " (15.9 mm) in diameter and raise the pizza about $\frac{1}{8}$ " (3.2 mm) above the surface of the pan.
- Any round or square pizza trays or pans measuring 2" (5.1 cm) deep or less, or between 8" (20.3 cm) and 20" (50.8 cm), can be made with nibs.
- Pans with nibs cannot be perforated.
- To order, add "N" to the beginning of the regular item number and note in the body of the order that the pans should be made with nibs.
- Refer to price list or amnow.com for pricing information.

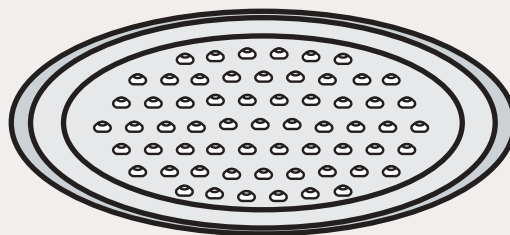

Perf (P)

Perforated pans allow the bottom of the pizza to cook faster and can provide a crispier crust. They can also keep cooked pizzas fresher by allowing moisture to escape.

- Holes are $\frac{3}{8}$ " (9.5 mm) in diameter.
- Round or square pizza trays or pans less than 21" (53.3 cm) in diameter can be perforated.
- Perf pans cannot be made with nibs.
- To order, add "P" to the beginning or end of the regular item number and note in the body of the order that the pans should be perforated.
- Refer to price list or amnow.com for pricing information.

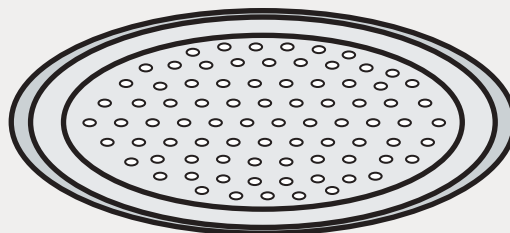

SuperPerf (SP)

SuperPerf pans have twice as many holes as Perf pans, allowing the bottom of the pizza to cook faster and providing a crispier crust. They can also keep cooked pizzas fresher by allowing moisture to escape.

- Holes are $\frac{3}{8}$ " (9.5 mm) in diameter.
- Round pans less than 21" (53.3 cm) in diameter can be SuperPerf.
- SuperPerf pans cannot be made with nibs.
- To order, add "SP" to the end of the regular item number and note in the body of the order that the pans should be SuperPerf.
- Refer to price list or amnow.com for pricing information.

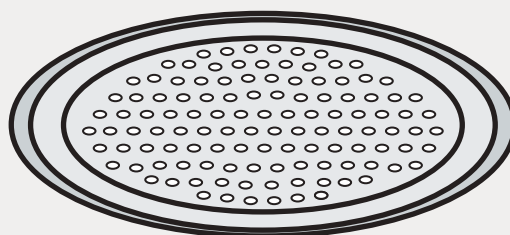

Perf and SuperPerf Hole Guide

| For pans with a maximum bottom inside diameter of: | | Number of Holes Standard Perf | Number of Holes Super Perf | For pans with a maximum bottom inside diameter of: | | Number of Holes Standard Perf | Number of Holes Super Perf |
|--|-----------|-------------------------------|----------------------------|--|-----------|-------------------------------|----------------------------|
| 5" | (12.7 cm) | 10 | 20 | 14" | (35.6 cm) | 185 | 370 |
| 6" | (15.2 cm) | 21 | 42 | 15" | (38.1 cm) | 185 | 370 |
| 7" | (17.8 cm) | 36 | 72 | 16" | (40.6 cm) | 228 | 456 |
| 8" | (20.3 cm) | 57 | 114 | 17" | (43.2 cm) | 275 | 550 |
| 9" | (22.9 cm) | 57 | 114 | 18" | (45.7 cm) | 275 | 550 |
| 10" | (25.4 cm) | 82 | 164 | 19" | (48.3 cm) | 326 | 652 |
| 11" | (27.9 cm) | 113 | 226 | 20" | (50.8 cm) | 379 | 758 |
| 12" | (30.5 cm) | 113 | 226 | 21" | (53.3 cm) | 379 | 758 |
| 13" | (33.0 cm) | 146 | 292 | | | | |

| | |
|--------------|----------------------|
| Perf P | Perforating Pans |
| SuperPerf SP | Double the Holes |
| Nibs N | Raised Nibs or Bumps |

This box is used throughout the Pizza Tray section to denote what options are available for each series. Please note that these options are made to order and may or may not be in stock. For pricing, visit amnow.com



Pizza Screens HOT 🔥

Screens allow for more air circulation than conventional pans, creating a more evenly baked crust.

Round Heavy-Duty Aluminum

- 18706** 6" OD (15.2 cm)
- 18707** 7" OD (17.8 cm)
- 18708** 8" OD (20.3 cm)
- 18709** 9" OD (22.9 cm)
- 18710** 10" OD (25.4 cm)
- 18711** 11" OD (27.9 cm)
- 18712** 12" OD (30.5 cm)
- 18713** 13" OD (33 cm)
- 18714** 14" OD (35.6 cm)
- 18715** 15" OD (38.1 cm)
- 18716** 16" OD (40.6 cm)
- 18717** 17" OD (43.2 cm)
- 18718** 18" OD (45.7 cm)
- 18719** 19" OD (48.3 cm)
- 18720** 20" OD (50.8 cm)
- 18724*** 24" OD (61 cm)
- 18728*** 28" OD (71.1 cm)

Rectangular Heavy-Duty Aluminum

- 18731*** 11" L x 16" W (27.9 x 40.6 cm)
Fits half-size bun pan
- 18744*** 16" L x 24" W (40.6 x 61 cm)
Fits full-size bun pan

Pizza Screen Rack 🔧

Inspired by our popular pizza racks on pg. 440, this piece holds up to 96 of our screens. Constructed from 3/16" (0.5 cm) chrome-plated steel rods.

- 18040** 14" L x 9" W x 10 1/2" H
(35.6 x 22.9 x 26.7 cm)



18711



18040

* Not available in seamless construction

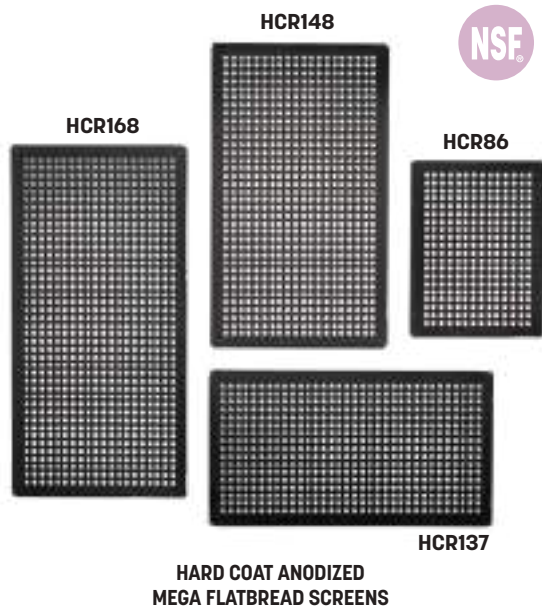

Mega Flatbread Screens - Hard Coat Anodized Aluminum

Why should round pizzas have all the fun? The durability and efficient-baking engineering of our Mega Screens meets a silhouette designed specifically for flatbreads. Features $\frac{3}{32}$ " (0.2 cm) Mega perforations.

Pan Size

8" L x 6 $\frac{1}{8}$ " W (20.3 x 15.6 cm)
 13" L x 7 $\frac{1}{8}$ " W (33 x 18.1 cm)
 14" L x 8" W (35.6 x 20.3 cm)
 16" L x 8" W (40.6 x 20.3 cm)

Hard Coat Anodized Aluminum

HCR86
HCR137
HCR148
HCR168

Mega Disks - Hard Coat Anodized Aluminum

Designed for durable and efficient baking, Mega Disks provide the maximum airflow to cook dough quickly and evenly. Lasts 5-10 times longer than normal screens. Features $\frac{3}{32}$ " (0.2 cm) Mega perforations.

Pan Size

10" Dia. (25.4 cm)
 12" Dia. (30.5 cm)
 14" Dia. (35.6 cm)
 16" Dia. (40.6 cm)
 18" Dia. (45.7 cm)

Hard Coat Anodized Aluminum

HCAD10
HCAD12
HCAD14
HCAD16
HCAD18

Mega Screens - Aluminum

Mega Screens are the smart choice for those looking for a more durable screen option. Holes and open rims make cleaning a breeze and improve food safety. Available in aluminum or hard coat anodized aluminum, Mega Screens can last 5 to 10 times longer than standard pizza screens. Hard Coat Mega Screens are the most durable, cost-effective screens for conveyor oven use. Holes are $\frac{3}{32}$ " (0.2 cm) in diameter.

Pan Size

10" ID x 10 $\frac{3}{4}$ " OD (25.4 x 27.3 cm)
 11" ID x 11 $\frac{3}{4}$ " OD (27.9 x 29.8 cm)
 12" ID x 12 $\frac{3}{4}$ " OD (30.5 x 32.4 cm)
 13" ID x 13 $\frac{3}{4}$ " OD (33.0 x 34.9 cm)
 14" ID x 14 $\frac{3}{4}$ " OD (35.6 x 37.5 cm)
 15" ID x 15 $\frac{3}{4}$ " OD (38.1 x 40 cm)
 16" ID x 16 $\frac{3}{4}$ " OD (40.6 x 42.5 cm)
 17" ID x 17 $\frac{3}{4}$ " OD (43.2 x 45.1 cm)
 18" ID x 18 $\frac{3}{4}$ " OD (45.7 x 47.6 cm)

Aluminum

28710
28711
28712
28713
28714
28715
28716
28717
28718

Hard Coat Anodized Aluminum

HC28710
HC28711
HC28712
HC28713
HC28714
HC28715
HC28716
HC28717
HC28718

Refer to pg. 458-459
for care and use
instructions.



P
Perf aluminum disk

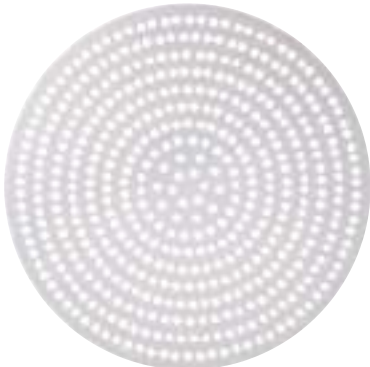

SP
SuperPerf aluminum disk

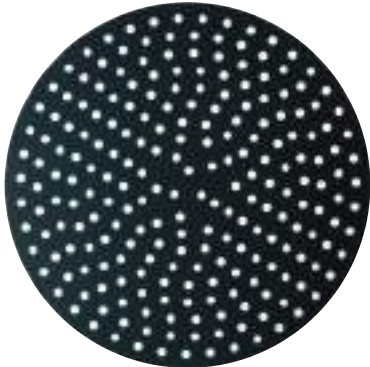

PHC
Perf hard coat anodized disk

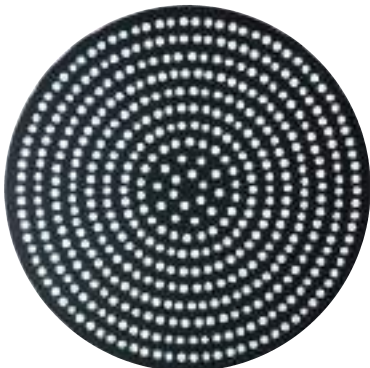

SPHC
SuperPerf hard coat anodized disk

Perf Disks - Aluminum

Manufactured from 18-ga. 1 mm aluminum, these perforated disks produce a more evenly baked crust by allowing for more air circulation. Holes measure 3/8" (9.5 mm) in diameter.

Pan Size

| | |
|-----------------------|-----------|
| 7 1/2" Dia. (19.1 cm) | 36 Holes |
| 8" Dia. (20.3 cm) | 57 Holes |
| 9" Dia. (22.9 cm) | 57 Holes |
| 10" Dia. (25.4 cm) | 82 Holes |
| 11" Dia. (27.9 cm) | 113 Holes |
| 12" Dia. (30.5 cm) | 113 Holes |
| 13" Dia. (33 cm) | 146 Holes |
| 14" Dia. (35.6 cm) | 185 Holes |
| 15" Dia. (38.1 cm) | 185 Holes |
| 16" Dia. (40.6 cm) | 228 Holes |
| 17" Dia. (43.2 cm) | 275 Holes |
| 18" Dia. (45.7 cm) | 275 Holes |
| 19" Dia. (48.3 cm) | 326 Holes |
| 20" Dia. (50.8 cm) | 379 Holes |

Aluminum

| |
|---------------|
| 18907P |
| 18908P |
| 18909P |
| 18910P |
| 18911P |
| 18912P |
| 18913P |
| 18914P |
| 18915P |
| 18916P |
| 18917P |
| 18918P |
| 18919P |
| 18920P |

Hard Coat Anodized Aluminum

| |
|-----------------|
| 18907PHC |
| 18908PHC |
| 18909PHC |
| 18910PHC |
| 18911PHC |
| 18912PHC |
| 18913PHC |
| 18914PHC |
| 18915PHC |
| 18916PHC |
| 18917PHC |
| 18918PHC |
| 18919PHC |
| 18920PHC |

SuperPerf Disks - Aluminum

Pan Size

| | |
|-----------------------|-----------|
| 7 1/2" Dia. (19.1 cm) | 72 Holes |
| 8" Dia. (20.3 cm) | 114 Holes |
| 9" Dia. (22.9 cm) | 114 Holes |
| 10" Dia. (25.4 cm) | 164 Holes |
| 11" Dia. (27.9 cm) | 226 Holes |
| 12" Dia. (30.5 cm) | 226 Holes |
| 13" Dia. (33 cm) | 292 Holes |
| 14" Dia. (35.6 cm) | 370 Holes |
| 15" Dia. (38.1 cm) | 370 Holes |
| 16" Dia. (40.6 cm) | 456 Holes |
| 17" Dia. (43.2 cm) | 550 Holes |
| 18" Dia. (45.7 cm) | 550 Holes |
| 19" Dia. (48.3 cm) | 652 Holes |
| 20" Dia. (50.8 cm) | 758 Holes |

Aluminum

| |
|----------------|
| 18907SP |
| 18908SP |
| 18909SP |
| 18910SP |
| 18911SP |
| 18912SP |
| 18913SP |
| 18914SP |
| 18915SP |
| 18916SP |
| 18917SP |
| 18918SP |
| 18919SP |
| 18920SP |

Hard Coat Anodized Aluminum

| |
|------------------|
| 18907SPHC |
| 18908SPHC |
| 18909SPHC |
| 18910SPHC |
| 18911SPHC |
| 18912SPHC |
| 18913SPHC |
| 18914SPHC |
| 18915SPHC |
| 18916SPHC |
| 18917SPHC |
| 18918SPHC |
| 18919SPHC |
| 18920SPHC |

SUPERPERF DISKS FEATURE TWICE AS MANY HOLES AS PERF DISKS



CAR PANS

Heavy-weight 14-ga., 1.5 mm aluminum



CAR HC PANS

Hard coat anodized 14-ga., 1.5 mm aluminum



SHARP EDGE ALSO CUTS DOUGH

CAR Pans - Tapered/Nesting

The edges of these pans are left unfinished so that they're sharp enough to cut dough. Just place a sheet of dough over the pan and use a rolling pin or pie roller to cut it down to size.

PAN DEPTH 5/8" (1.6 CM)

Pan Size

- 6" Top OD x 5" Bottom ID (15.2 x 12.7 cm)
- 7" Top OD x 6" Bottom ID (17.8 x 15.2 cm)
- 7 3/4" Top OD x 6 3/4" Bottom ID (19.7 x 17.1 cm)
- 8 1/2" Top OD x 7 1/2" Bottom ID (21.6 x 19.1 cm)

**Heavy-Weight
14-ga., 1.5 mm Aluminum**

- CAR6
- CAR7
- CAR8
- CAR9

**Hard Coat Anodized
14-ga., 1.5 mm Aluminum**

- CAR6HC
- CAR7HC
- CAR8HC
- CAR9HC

PAN DEPTH 7/16" (1.7 CM)

Pan Size

- 9" Top OD x 8" Bottom ID (22.9 x 20.3 cm)
- 10" Top OD x 9" Bottom ID (25.4 x 22.9 cm)
- 11" Top OD x 10" Bottom ID (27.9 x 25.4 cm)
- 12" Top OD x 11" Bottom ID (30.5 x 27.9 cm)
- 13" Top OD x 12" Bottom ID (33 x 30.5 cm)
- 14" Top OD x 13" Bottom ID (35.6 x 33 cm)
- 15" Top OD x 14" Bottom ID (38.1 x 35.6 cm)
- 16" Top OD x 15" Bottom ID (40.6 x 38.1 cm)
- 17" Top OD x 16" Bottom ID (43.2 x 40.6 cm)
- 18" Top OD x 17" Bottom ID (45.7 x 43.2 cm)
- 19" Top OD x 18" Bottom ID (48.3 x 45.7 cm)
- 20" Top OD x 19" Bottom ID (50.8 x 48.3 cm)
- 21" Top OD x 20" Bottom ID (53.3 x 50.8 cm)

- CAR95
- CAR10
- CAR11
- CAR12
- CAR13
- CAR14
- CAR15
- CAR16
- CAR17
- CAR18
- CAR19
- CAR20
- CAR21

- CAR95HC
- CAR10HC
- CAR11HC
- CAR12HC
- CAR13HC
- CAR14HC
- CAR15HC
- CAR16HC
- CAR17HC
- CAR18HC
- CAR19HC
- CAR20HC
- CAR21HC

HOT

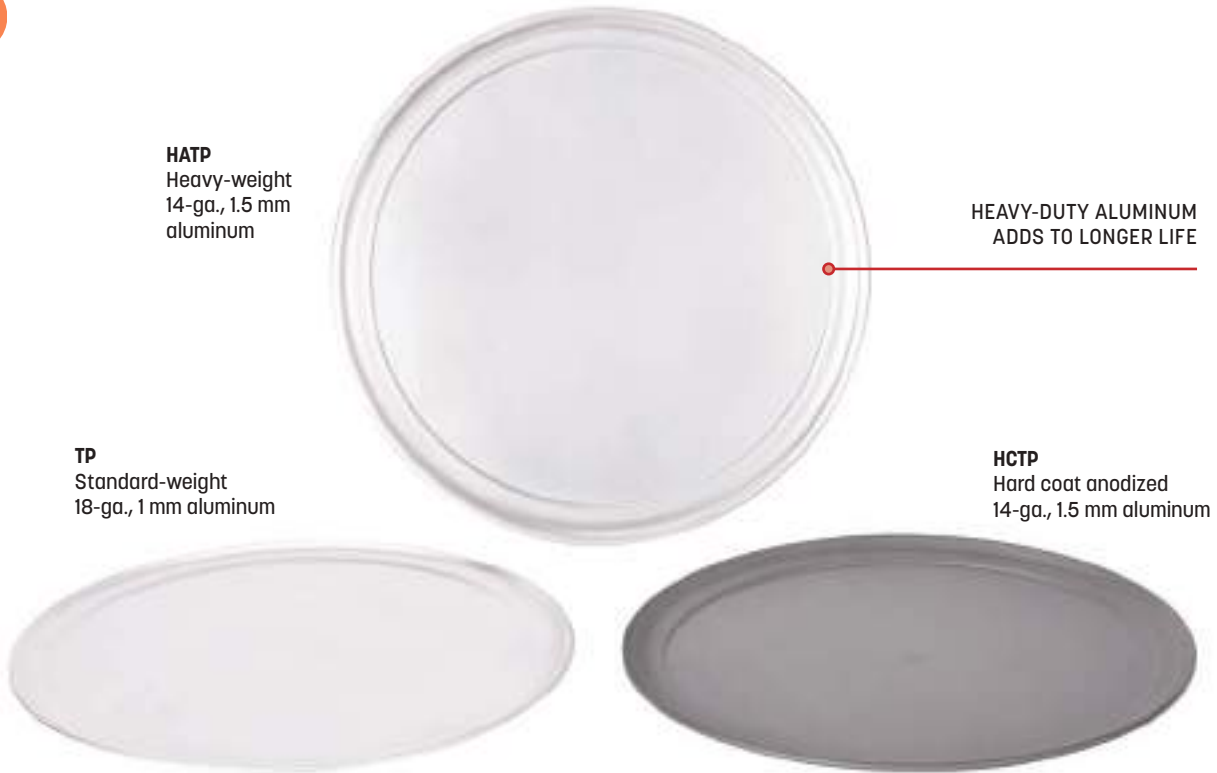

HATP
 Heavy-weight
 14-ga., 1.5 mm
 aluminum

HEAVY-DUTY ALUMINUM
 ADDS TO LONGER LIFE

TP
 Standard-weight
 18-ga., 1 mm
 aluminum

HCTP
 Hard coat anodized
 14-ga., 1.5 mm
 aluminum

TP Series Wide-Rim Pans HOT USA

There's a reason that the pizza industry has trusted American Metalcraft since 1947. Often imitated, but never duplicated, our signature TP Series of serving trays offers unbeatable reliability and durability, thanks to heavy-duty 14 and 18-ga. aluminum construction.

| Pan Size | TP Standard-Weight 18-ga., 1 mm Aluminum | HATP Heavy-Weight 14-ga., 1.5 mm Aluminum USA | HCTP Hard Coat Anodized 14-ga., 1.5 mm Aluminum USA |
|------------------------------------|--|---|---|
| 6" OD x 4 1/2" ID (15.2 x 11.4 cm) | TP6 | HATP6 | HCTP6 |
| 7" OD x 5 1/2" ID (17.9 x 14 cm) | TP7 | HATP7 | HCTP7 |
| 8" OD x 6" ID (20.3 x 15.2 cm) | TP8 | HATP8 | HCTP8 |
| 9" OD x 7" ID (22.9 x 17.9 cm) | TP9 | HATP9 | HCTP9 |
| 10" OD x 8" ID (25.4 x 20.3 cm) | TP10 | HATP10 | HCTP10 |
| 11" OD x 9" ID (27.9 x 22.9 cm) | TP11 | HATP11 | HCTP11 |
| 12" OD x 10" ID (30.5 x 25.4 cm) | TP12 | HATP12 | HCTP12 |
| 13" OD x 11" ID (33 x 27.9 cm) | TP13 | HATP13 | HCTP13 |
| 14" OD x 12" ID (35.6 x 30.5 cm) | TP14 | HATP14 | HCTP14 |
| 15" OD x 13" ID (38.1 x 33 cm) | TP15 | HATP15 | HCTP15 |
| 16" OD x 14" ID (40.6 x 35.6 cm) | TP16 | HATP16 | HCTP16 |
| 17" OD x 15" ID (43.2 x 38.1 cm) | TP17 | HATP17 | HCTP17 |
| 18" OD x 16" ID (45.7 x 40.6 cm) | TP18 | HATP18 | HCTP18 |
| 19" OD x 17" ID (48.3 x 43.2 cm) | TP19 | HATP19 | HCTP19 |
| 20" OD x 18" ID (50.8 x 45.7 cm) | TP20 | HATP20 | HCTP20 |
| 21" OD x 19" ID (53.3 x 48.3 cm) | | HATP21 | |
| 22" OD x 20" ID (55.9 x 50.8 cm) | | HATP22 | |
| 23" OD x 21" ID (58.4 x 53.3 cm) | | HATP23 | |
| 24" OD x 22" ID (61 x 55.9 cm) | | HATP24 | |
| 26" OD x 24" ID (66 x 61 cm) | | HATP26 | |
| 28" OD x 26" ID (71.1 x 66 cm) | | HATP28 | |

Perf P Perforating Pans
SuperPerf SP Double the Holes
Nibs N Raised Nibs or Bumps

Refer to pg. 458-459 for care and use instructions.
 For pricing, visit amnow.com



HACTP
Heavy-weight
14-ga., 1.5 mm
aluminum

CTP
Standard-weight
18-ga., 1 mm aluminum

HCCTP
Hard coat anodized
14-ga., 1.5 mm aluminum

CTP Series Coupe-Style Pans

Just like our signature TP Series, these coupe-style pans are manufactured from the finest grade of aluminum. They'll last longer than your average pizza pan, making them a financially savvy choice to serve pizzas.

| <u>Pan Size</u> | <u>CTP Standard-Weight 18-ga., 1 mm Aluminum</u> | <u>HACTP Heavy-Weight 14-ga., 1.5 mm Aluminum</u> | <u>HCCTP Hard Coat Anodized 14-ga., 1.5 mm Aluminum</u> |
|------------------------------------|--|---|---|
| 6" OD x 4 1/2" ID (15.2 x 11.4 cm) | CTP6 | HACTP6 | HCCTP6 |
| 7" OD x 5 1/2" ID (17.9 x 14 cm) | CTP7 | HACTP7 | HCCTP7 |
| 8" OD x 6" ID (20.3 x 15.2 cm) | CTP8 | HACTP8 | HCCTP8 |
| 9" OD x 7" ID (22.9 x 17.9 cm) | CTP9 | HACTP9 | HCCTP9 |
| 10" OD x 8" ID (25.4 x 20.3 cm) | CTP10 | HACTP10 | HCCTP10 |
| 11" OD x 9" ID (27.9 x 22.9 cm) | CTP11 | HACTP11 | HCCTP11 |
| 12" OD x 10" ID (30.5 x 25.4 cm) | CTP12 | HACTP12 | HCCTP12 |
| 13" OD x 11" ID (33 x 27.9 cm) | CTP13 | HACTP13 | HCCTP13 |
| 14" OD x 12" ID (35.6 x 30.5 cm) | CTP14 | HACTP14 | HCCTP14 |
| 15" OD x 13" ID (38.1 x 33 cm) | CTP15 | HACTP15 | HCCTP15 |
| 16" OD x 14" ID (40.6 x 35.6 cm) | CTP16 | HACTP16 | HCCTP16 |
| 17" OD x 15" ID (43.2 x 38.1 cm) | CTP17 | HACTP17 | HCCTP17 |
| 18" OD x 16" ID (45.7 x 40.6 cm) | CTP18 | HACTP18 | HCCTP18 |
| 19" OD x 17" ID (48.3 x 43.2 cm) | CTP19 | HACTP19 | HCCTP19 |
| 20" OD x 18" ID (50.8 x 45.7 cm) | | HACTP20 | HCCTP20 |
| 21" OD x 19" ID (53.3 x 48.3 cm) | | HACTP21 | |
| 22" OD x 20" ID (55.9 x 50.8 cm) | | HACTP22 | |
| 23" OD x 21" ID (58.4 x 53.3 cm) | | HACTP23 | |
| 24" OD x 22" ID (61 x 55.9 cm) | | HACTP24 | |
| 26" OD x 24" ID (66 x 61 cm) | | HACTP26 | |
| 28" OD x 26" ID (71.1 x 66 cm) | | HACTP28 | |

Perf P Perforating Pans
SuperPerf SP Double the Holes
Nibs N Raised Nibs or Bumps

Refer to pg. 458-459 for care and use instructions.
For pricing, visit amnow.com



A2000
Standard-weight
18-ga., 1 mm aluminum

HA2000
Heavy-weight
14-ga., 1.5 mm aluminum



DESIGNED TO NEST FOR
SPACE-SAVING STORAGE



HC2000
Hard coat anodized
14-ga., 1.5 mm aluminum

2000 Series - Tapered/Nesting

The 2000 series is bringing the heat! Available in multiple diameters and in a depth of 1/2" (1.3 cm), these pizza pans are perfect for baking hand-tossed, topping-loaded pizzas. Their high-quality, durable aluminum construction heats quickly and evenly, then easily nests to take up minimal storage space.

PAN DEPTH 1/2" (1.3 CM)

Pan Size

| |
|---|
| 6" Top ID x 5 5/8" Bottom ID (15.2 x 14.3 cm) |
| 7" Top ID x 6 5/8" Bottom ID (17.9 x 16.8 cm) |
| 8" Top ID x 7 5/8" Bottom ID (20.3 x 19.4 cm) |
| 9" Top ID x 8 5/8" Bottom ID (22.9 x 21.9 cm) |
| 10" Top ID x 9 5/8" Bottom ID (25.4 x 24.4 cm) |
| 11" Top ID x 10 5/8" Bottom ID (27.9 x 27 cm) |
| 12" Top ID x 11 5/8" Bottom ID (30.5 x 29.5 cm) |
| 13" Top ID x 12 5/8" Bottom ID (33 x 32.1 cm) |
| 14" Top ID x 13 5/8" Bottom ID (35.6 x 34.6 cm) |
| 15" Top ID x 14 5/8" Bottom ID (38.1 x 37.1 cm) |
| 16" Top ID x 15 5/8" Bottom ID (40.6 x 39.7 cm) |
| 17" Top ID x 16 5/8" Bottom ID (43.2 x 42.2 cm) |
| 18" Top ID x 17 5/8" Bottom ID (45.7 x 44.8 cm) |

**A2000 Standard-Weight
18-ga., 1 mm Aluminum**

| |
|-------|
| A2006 |
| A2007 |
| A2008 |
| A2009 |
| A2010 |
| A2011 |
| A2012 |
| A2013 |
| A2014 |
| A2015 |
| A2016 |
| A2017 |
| A2018 |

**HA2000 Heavy-Weight
14-ga., 1.5 mm Aluminum**

| |
|--------|
| HA2006 |
| HA2007 |
| HA2008 |
| HA2009 |
| HA2010 |
| HA2011 |
| HA2012 |
| HA2013 |
| HA2014 |
| HA2015 |
| HA2016 |
| HA2017 |
| HA2018 |

**HC2000 Hard Coat Anodized
14-ga., 1.5 mm Aluminum**

| |
|--------|
| HC2006 |
| HC2007 |
| HC2008 |
| HC2009 |
| HC2010 |
| HC2011 |
| HC2012 |
| HC2013 |
| HC2014 |
| HC2015 |
| HC2016 |
| HC2017 |
| HC2018 |

Perf P Perforating Pans
SuperPerf SP Double the Holes
Nibs N Raised Nibs or Bumps

Covers Separators and 7000 pans (pg. 415) can be used as covers
Stacking 7000 pans (pg. 415) are stacking covers for tapered pans
Refer to pg. 458-459 for care and use instructions. For pricing, visit annow.com

HADEP
Heavy-weight
14-ga., 1.5 mm aluminum



ADEP
Standard-weight
18-ga., 1 mm aluminum



HCDEP
Hard coat anodized
14-ga., 1.5 mm aluminum

DEP Series - Tapered/Nesting

Bring on the deep dish with the DEP Series! Available in a depth of 1" (2.5 cm), these durable aluminum pizza pans are perfect for baking hearty deep dish pizzas. And with multiple diameters and finishes, you are sure to find the right pan to cook quickly and evenly, then nest conveniently for storage.

PAN DEPTH 1" (2.5 CM)

Pan Size

- 6" Top ID x 5 5/8" Bottom ID (15.2 x 14.3 cm)
- 7" Top ID x 6 5/8" Bottom ID (17.9 x 16.8 cm)
- 8" Top ID x 7 5/8" Bottom ID (20.3 x 19.4 cm)
- 9" Top ID x 8 5/8" Bottom ID (22.9 x 21.9 cm)
- 10" Top ID x 9 5/8" Bottom ID (25.4 x 24.4 cm)
- 11" Top ID x 10 5/8" Bottom ID (27.9 x 27 cm)
- 12" Top ID x 11 5/8" Bottom ID (30.5 x 29.5 cm)
- 13" Top ID x 12 5/8" Bottom ID (33 x 32.1 cm)
- 14" Top ID x 13 5/8" Bottom ID (35.6 x 34.6 cm)
- 15" Top ID x 14 5/8" Bottom ID (38.1 x 37.1 cm)
- 16" Top ID x 15 5/8" Bottom ID (40.6 x 39.7 cm)
- 17" Top ID x 16 5/8" Bottom ID (43.2 x 42.2 cm)
- 18" Top ID x 17 5/8" Bottom ID (45.7 x 44.8 cm)
- 19" Top ID x 18 1/4" Bottom ID (48.3 x 46.4 cm)

**ADEP Standard-Weight
18-ga., 1 mm Aluminum**

- ADEP6
- ADEP7
- ADEP8
- ADEP9
- ADEP10
- ADEP11
- ADEP12
- ADEP13
- ADEP14
- ADEP15
- ADEP16
- ADEP17
- ADEP18

**HADEP Heavy-Weight
14-ga., 1.5 mm Aluminum**

- HADEP6
- HADEP7
- HADEP8
- HADEP9
- HADEP10
- HADEP11
- HADEP12
- HADEP13
- HADEP14
- HADEP15
- HADEP16
- HADEP17
- HADEP18
- HADEP19

**HCDEP Hard Coat Anodized
14-ga., 1.5 mm Aluminum**

- HCDEP6
- HCDEP7
- HCDEP8
- HCDEP9
- HCDEP10
- HCDEP11
- HCDEP12
- HCDEP13
- HCDEP14
- HCDEP15
- HCDEP16
- HCDEP17
- HCDEP18

Perf P Perforating Pans
SuperPerf SP Double the Holes
Nibs N Raised Nibs or Bumps

Covers Separators and 7000 pans (pg. 415) can be used as covers
Stacking 7000 pans (pg. 415) are stacking covers for tapered pans
Refer to pg. 458-459 for care and use instructions. For pricing, visit amnow.com



9000 Series Pan shown seasoned



A9000
Standard-weight
18-ga., 1 mm aluminum



9000 SERIES - Tapered/Nesting 

Impress customers with delicious deep dish pizzas. The 9000 series provides versatile height and diameter options, along with multiple material choices to create the perfect pizza. The result is efficiently and evenly cooked deep dish pizzas, with all of the fixings, each and every time. Pans are tapered to nest for space-saving storage.

PAN DEPTH 1 1/8" (2.9 CM)

Pan Size

- 5" Top ID x 4 3/8" Bottom ID (12.7 x 11.1 cm)
- 5 1/2" Top ID x 5" Bottom ID (13.9 x 12.7 cm)

**A9000 Standard-Weight
18-ga., 1 mm Aluminum**

- A9005**
- A9006**

PAN DEPTH 1 1/2" (3.8 CM)

Pan Size

- 6" Top ID x 5 1/2" Bottom ID (15.2 x 14 cm)
- 7" Top ID x 6 1/4" Bottom ID (17.8 x 15.9 cm)
- 8" Top ID x 7 1/4" Bottom ID (20.3 x 18.4 cm)
- 9" Top ID x 8 1/4" Bottom ID (22.9 x 21 cm)
- 10" Top ID x 9 1/4" Bottom ID (25.4 x 23.5 cm)
- 11" Top ID x 10 1/4" Bottom ID (27.9 x 26 cm)
- 12" Top ID x 11 1/4" Bottom ID (30.5 x 28.6 cm)
- 13" Top ID x 12 1/4" Bottom ID (33 x 31.1 cm)
- 14" Top ID x 13 1/4" Bottom ID (35.6 x 33.7 cm)
- 15" Top ID x 14 1/4" Bottom ID (38.1 x 36.2 cm)
- 16" Top ID x 15 1/4" Bottom ID (40.6 x 38.7 cm)

- A90671.5**
- A90071.5**
- A90081.5**
- A90091.5**
- A90101.5**
- A90111.5**
- A90121.5**
- A90131.5**
- A90141.5**
- A90151.5**
- A90161.5**

PAN DEPTH 2" (5.1 CM)

Pan Size

- 6" Top ID x 5" Bottom ID (15.2 x 12.7 cm)
- 7" Top ID x 6" Bottom ID (17.8 x 15.2 cm)
- 8" Top ID x 7" Bottom ID (20.3 x 17.8 cm)
- 9" Top ID x 8" Bottom ID (22.9 x 20.3 cm)
- 10" Top ID x 9" Bottom ID (25.4 x 22.9 cm)
- 11" Top ID x 10" Bottom ID (27.9 x 25.4 cm)
- 12" Top ID x 11" Bottom ID (30.5 x 27.9 cm)
- 13" Top ID x 12" Bottom ID (33 x 30.5 cm)
- 14" Top ID x 13" Bottom ID (35.6 x 33 cm)
- 15" Top ID x 14" Bottom ID (38.1 x 35.6 cm)
- 16" Top ID x 15" Bottom ID (40.6 x 38.1 cm)

- A90672**
- A90072**
- A90082**
- A90092**
- A90102**
- A90112**
- A90122**
- A90132**
- A90142**
- A90152**
- A90162**

HA9000
Heavy-weight
14-ga., 1.5 mm
aluminum



HC9000
Hard coat anodized
14-ga., 1.5 mm
aluminum



9000 SERIES - Tapered/Nesting

PAN DEPTH 1 1/8" (2.9 CM)

Pan Size

5" Top ID x 4 3/8" Bottom ID (12.7 x 11.1 cm)

5 1/2" Top ID x 5" Bottom ID (14 x 12.7 cm)

**HA9000 Heavy-Weight
14-ga., 1.5 mm Aluminum**

HA9005

HA9006

**HC9000 Hard Coat Anodized
14-ga., 1.5 mm Aluminum**

HC9005

HC9006

PAN DEPTH 1 1/2" (3.8 CM)

Pan Size

6" Top ID x 5 1/2" Bottom ID (15.2 x 14 cm)

7" Top ID x 6 1/4" Bottom ID (17.8 x 15.9 cm)

8" Top ID x 7 1/4" Bottom ID (20.3 x 18.4 cm)

9" Top ID x 8 1/4" Bottom ID (22.9 x 21 cm)

10" Top ID x 9 1/4" Bottom ID (25.4 x 23.5 cm)

11" Top ID x 10 1/4" Bottom ID (27.9 x 26 cm)

12" Top ID x 11 1/4" Bottom ID (30.5 x 28.6 cm)

13" Top ID x 12 1/4" Bottom ID (33 x 31.1 cm)

14" Top ID x 13 1/4" Bottom ID (35.6 x 33.7 cm)

15" Top ID x 14 1/4" Bottom ID (38.1 x 36.2 cm)

16" Top ID x 15 1/4" Bottom ID (40.6 x 38.7 cm)

17" Top ID x 16 1/4" Bottom ID (43.2 x 41.3 cm)

18" Top ID x 17 1/4" Bottom ID (45.7 x 43.8 cm)

HA90671.5

HA90071.5

HA90081.5

HA90091.5

HA90101.5

HA90111.5

HA90121.5

HA90131.5

HA90141.5

HA90151.5

HA90161.5

HA90171.5

HA90181.5

HC90671.5

HC90071.5

HC90081.5

HC90091.5

HC90101.5

HC90111.5

HC90121.5

HC90131.5

HC90141.5

HC90151.5

HC90161.5

HC90171.5

HC90181.5

PAN DEPTH 2" (5.1 CM)

Pan Size

6" Top ID x 5" Bottom ID (15.2 x 12.7 cm)

7" Top ID x 6" Bottom ID (17.8 x 15.2 cm)

8" Top ID x 7" Bottom ID (20.3 x 17.8 cm)

9" Top ID x 8" Bottom ID (22.9 x 20.3 cm)

10" Top ID x 9" Bottom ID (25.4 x 22.9 cm)

11" Top ID x 10" Bottom ID (27.9 x 25.4 cm)

12" Top ID x 11" Bottom ID (30.5 x 27.9 cm)

13" Top ID x 12" Bottom ID (33 x 30.5 cm)

14" Top ID x 13" Bottom ID (35.6 x 33 cm)

15" Top ID x 14" Bottom ID (38.1 x 35.6 cm)

16" Top ID x 15" Bottom ID (40.6 x 38.1 cm)

17" Top ID x 16" Bottom ID (43.2 x 40.6 cm)

18" Top ID x 17" Bottom ID (45.7 x 43.2 cm)

HA90672

HA90072

HA90082

HA90092

HA90102

HA90112

HA90122

HA90132

HA90142

HA90152

HA90162

HA90172

HA90182

HC90672

HC90072

HC90082

HC90092

HC90102

HC90112

HC90122

HC90132

HC90142

HC90152

HC90162

HC90172

HC90182



A4000
Standard-weight
18-ga., 1 mm
aluminum



HA4000
Heavy-weight
14-ga., 1.5 mm
aluminum



HC4000
Hard coat anodized
14-ga., 1.5 mm
aluminum



4000 SERIES - Straight-Sided

Versatility and durability make the 4000 series one of our best sellers. Available in multiple diameters and depths from 3/4"-1" (1.9-2.5 cm), these pans are perfect for baking anything from double-dough pizzas to cookies and brownies. Each pan is made of high-quality, aluminum which heats quickly and efficiently and the straight sides ensure symmetrical, uniform, and smooth edges.

PAN DEPTH 3/4" (1.9 CM)

Pan Size

4" ID (10.2 cm)

Standard-Weight
18-ga., 1 mm Aluminum

A4004

Heavy-Weight
14-ga., 1.5 mm Aluminum

Hard Coat Anodized
14-ga., 1.5 mm Aluminum

PAN DEPTH 1" (2.5 CM)

Pan Size

6" ID (15.2 cm)

7" ID (17.8 cm)

8" ID (20.3 cm)

9" ID (22.9 cm)

10" ID (25.4 cm)

11" ID (27.9 cm)

12" ID (30.5 cm)

13" ID (33 cm)

14" ID (35.6 cm)

15" ID (38.1 cm)

16" ID (40.6 cm)

17" ID (43.2 cm)

18" ID (45.7 cm)

19" ID (48.3 cm)

20" ID (50.8 cm)

A4006

A4007

A4008

A4009

A4010

A4011

A4012

A4013

A4014

A4015

A4016

HA4006

HA4007

HA4008

HA4009

HA4010

HA4011

HA4012

HA4013

HA4014

HA4015

HA4016

HA4017

HA4018

HA4019

HA4020

HC4006

HC4007

HC4008

HC4009

HC4010

HC4011

HC4012

HC4013

HC4014

HC4015

HC4016

HC4017

HC4018

HC4019

HC4020

8000 SERIES - Straight-Sided 

Straight-sided and deep, these pans are the hallmark of deep dish pizzas around the globe. Choose from a variety of diameter, depth, and material combinations for evenly and efficiently-cooked Chicago-style and pan pizza crusts. Plus, each size has straight sides for a perfect 90° angle crust every time.



PAN DEPTH 1 1/2" (3.8 CM)

Pan Size

- 6" ID (15.2 cm)
- 7" ID (17.8 cm)
- 8" ID (20.3 cm)
- 9" ID (22.9 cm)
- 10" ID (25.4 cm)
- 12" ID (30.5 cm)

A8000 Standard-Weight 18-ga., 1 mm Aluminum

- A80061.5
- A80071.5
- A80081.5
- A80091.5
- A80101.5
- A80121.5

T8000 Tin Plate 22-ga., Tin Plate on Steel

- T80061.5
- T80071.5
- T80081.5
- T80091.5
- T80101.5
- T80121.5



A8000
Standard-weight 18-ga., 1 mm aluminum

PAN DEPTH 2" (5.1 CM)

Pan Size

- 6" ID (15.2 cm)
- 7" ID (17.8 cm)
- 8" ID (20.3 cm)
- 9" ID (22.9 cm)
- 10" ID (25.4 cm)
- 11" ID (27.9 cm)
- 12" ID (30.5 cm)
- 13" ID (33 cm)
- 14" ID (35.6 cm)
- 16" ID (40.6 cm)

- A80062
- A80072
- A80082
- A80092
- A80102
- A80112
- A80122
- A80132
- A80142
- A80162

- T80062
- T80072
- T80082
- T80092
- T80102
- T80112
- T80122
- T80132
- T80142
- T80162



T8000
22-ga., tin plate on steel

PAN DEPTH 1 1/2" (3.8 CM)

Pan Size

- 6" ID (15.2 cm)
- 7" ID (17.8 cm)
- 8" ID (20.3 cm)
- 9" ID (22.9 cm)
- 10" ID (25.4 cm)
- 12" ID (30.5 cm)

HA8000 Heavy-Weight 14-ga., 1.5 mm Aluminum

- HA80061.5
- HA80071.5
- HA80081.5
- HA80091.5
- HA80101.5
- HA80121.5

HC8000 Hard Coat Anodized 14-ga., 1.5 mm Aluminum

- HC80061.5
- HC80071.5
- HC80081.5
- HC80091.5
- HC80101.5
- HC80121.5



HA8000
Heavy-weight 14-ga., 1.5 mm aluminum

PAN DEPTH 2" (5.1 CM)

Pan Size

- 6" ID (15.2 cm)
- 7" ID (17.8 cm)
- 8" ID (20.3 cm)
- 9" ID (22.9 cm)
- 10" ID (25.4 cm)
- 11" ID (27.9 cm)
- 12" ID (30.5 cm)
- 13" ID (33 cm)
- 14" ID (35.6 cm)
- 16" ID (40.6 cm)
- 18" ID (45.7 cm)

- HA80062
- HA80072
- HA80082
- HA80092
- HA80102
- HA80112
- HA80122
- HA80132
- HA80142
- HA80162
- HA80182

- HC80062
- HC80072
- HC80082
- HC80092
- HC80102
- HC80112
- HC80122
- HC80132
- HC80142
- HC80162
- HC80182



HC8000
Hard coat anodized 14-ga., 1.5 mm aluminum



8000 SERIES PANS ARE PERFECT FOR DEEP DISH PIZZA

Perf P Perforating Pans
SuperPerf SP Double the Holes
Nibs N Raised Nibs or Bumps

Covers Separators and 7000 pans (pg. 415) can be used as covers
Stacking 7000 pans (pg. 415) are stacking covers for tapered pans
 Refer to pg. 458-459 for care and use instructions. For pricing, visit amnow.com

ALL PANS ARE 1 1/2" DEEP WITH 1" INSIDE PAN WHEN STACKED. BOTTOM OF ONE PAN NESTS 1/2" INTO THE TOP OF THE PAN BELOW.



USA

HC5100
Hard coat
anodized
14-ga., 1.5 mm
aluminum

USA



HA5100
Heavy-weight
14-ga., 1.5 mm
aluminum

ALL PANS ARE 2" DEEP WITH 1 1/2" INSIDE PAN WHEN STACKED. BOTTOM OF ONE PAN NESTS 1/2" INTO THE TOP OF THE PAN BELOW.



HA5000
Heavy-weight
14-ga., 1.5 mm
aluminum

HC5000
Hard coat
anodized
14-ga., 1.5 mm
aluminum



5100 SERIES - Straight-Sided - Self-Stacking

The 5100 Series is your new best friend! Available in a large range of diameters and a depth of 1 1/2" (3.8 cm), these pans provide a self-stacking ridge allowing you to prep and stack pizzas prior to cooking. No lids required.

PAN DEPTH 1 1/2" (3.8 CM)

Pan Size

6" Top ID x 5 7/8" Bottom ID (15.2 x 14.9 cm)
7" Top ID x 6 7/8" Bottom ID (17.8 x 17.5 cm)
8" Top ID x 7 7/8" Bottom ID (20.3 x 20 cm)
9" Top ID x 8 7/8" Bottom ID (22.9 x 22.5 cm)
10" Top ID x 9 7/8" Bottom ID (25.4 x 25.1 cm)
11" Top ID x 10 7/8" Bottom ID (27.9 x 27.6 cm)
12" Top ID x 11 7/8" Bottom ID (30.5 x 30.2 cm)
13" Top ID x 12 7/8" Bottom ID (33 x 32.7 cm)
14" Top ID x 13 7/8" Bottom ID (35.6 x 35.3 cm)
15" Top ID x 14 7/8" Bottom ID (38.1 x 37.8 cm)
16" Top ID x 15 7/8" Bottom ID (40.6 x 40.3 cm)

HA5100 Heavy-Weight **14-ga., 1.5 mm Aluminum**

HA5106
HA5107
HA5108
HA5109
HA5110
HA5111
HA5112
HA5113
HA5114
HA5115
HA5116

HC5100 Hard Coat Anodized **14-ga., 1.5 mm Aluminum**

HC5106
HC5107
HC5108
HC5109
HC5110
HC5111
HC5112
HC5113
HC5114
HC5115
HC5116

5000 SERIES - Straight-Sided - Self-Stacking

Proof, prep and cook all in one pan with the 5000 Series. Multiple diameter options along with an ample 2" depth (5.1 cm) make these pans ideal for deep dish pizzas. Plus, the convenient self-stacking design allows for prep and proofing in less space.

PAN DEPTH 2" (5.1 CM)

Pan Size

6" Top ID x 5 7/8" Bottom ID (15.2 x 14.9 cm)
7" Top ID x 6 7/8" Bottom ID (17.8 x 17.5 cm)
8" Top ID x 7 7/8" Bottom ID (20.3 x 20 cm)
9" Top ID x 8 7/8" Bottom ID (22.9 x 22.5 cm)
10" Top ID x 9 7/8" Bottom ID (25.4 x 25.1 cm)
11" Top ID x 10 7/8" Bottom ID (27.9 x 27.6 cm)
12" Top ID x 11 7/8" Bottom ID (30.5 x 30.1 cm)
13" Top ID x 12 7/8" Bottom ID (33 x 32.7 cm)
14" Top ID x 13 7/8" Bottom ID (35.6 x 35.3 cm)
15" Top ID x 14 7/8" Bottom ID (38.1 x 37.8 cm)
16" Top ID x 15 7/8" Bottom ID (40.6 x 40.3 cm)
17" Top ID x 16 7/8" Bottom ID (43.2 x 42.9 cm)
18" Top ID x 17 7/8" Bottom ID (45.7 x 45.4 cm)

HA5000 Heavy-Weight **14-ga., 1.5 mm Aluminum**

HA5006
HA5007
HA5008
HA5009
HA5010
HA5011
HA5012
HA5013
HA5014
HA5015
HA5016
HA5017
HA5018

HC5000 Hard Coat Anodized **14-ga., 1.5 mm Aluminum**

HC5006
HC5007
HC5008
HC5009
HC5010
HC5011
HC5012
HC5013
HC5014
HC5015
HC5016
HC5017
HC5018



18914

ROUND SEPARATORS



To choose a separator, measure the top outside diameter of your pan and add at least 2". Unfinished edges may be sharp.

Standard-Weight 18-ga., 1 mm Aluminum

| | |
|--------------|---|
| 18907 | 7 1/2" OD (19.1 cm) Separates 5 1/2" (14 cm) Dia. and smaller pans |
| 18908 | 8" OD (20.3 cm) Separates 6" (15.2 cm) Dia. and smaller pans |
| 18909 | 9" OD (22.9 cm) Separates 7" (17.8 cm) Dia. and smaller pans |
| 18910 | 10" OD (25.4 cm) Separates 8" (20.3 cm) Dia. and smaller pans |
| 18911 | 11" OD (27.9 cm) Separates 9" (22.9 cm) Dia. and smaller pans |
| 18912 | 12" OD (30.5 cm) Separates 10" (25.4 cm) Dia. and smaller pans |
| 18913 | 13" OD (33 cm) Separates 11" (27.9 cm) Dia. and smaller pans |
| 18914 | 14" OD (35.6 cm) Separates 12" (30.5 cm) Dia. and smaller pans |
| 18915 | 15" OD (38.1 cm) Separates 13" (33 cm) Dia. and smaller pans |
| 18916 | 16" OD (40.6 cm) Separates 14" (35.6 cm) Dia. and smaller pans |
| 18917 | 17" OD (43.2 cm) Separates 15" (38.1 cm) Dia. and smaller pans |
| 18918 | 18" OD (45.7 cm) Separates 16" (40.6 cm) Dia. and smaller pans |
| 18919 | 19" OD (48.3 cm) Separates 17" (43.2 cm) Dia. and smaller pans |
| 18920 | 20" OD (50.8 cm) Separates 18" (45.7 cm) Dia. and smaller pans |

7000 SERIES



These can be used as stacking covers for our DEP, 2000 and 9000 Series, or just as covers for our 4000, 8000, 5000 and 5100 Series. To choose a cover, measure the top inside diameter and reference the list below.

7000 Standard-Weight 18-ga., 1 mm Aluminum

| | |
|-------------|---|
| 7006 | 5 3/4" ID x 7 1/2" OD x 1/4" Deep, for 6" ID pans (14.6 x 19.1 x 0.6 cm, for 15.2 cm pans) Cover only for 4006, 8006, 5006, 5106, Stacking Cover for DEP6, 2006, 9006 |
| 7007 | 6 3/4" ID x 8 1/2" OD x 1/4" Deep, for 7" ID pans (17.1 x 21.6 x 0.6 cm, for 17.8 cm pans) Cover only for 4007, 8007, 5007, 5107, Stacking Cover for DEP7, 2007, 9007 |
| 7008 | 7 3/4" ID x 9 1/2" OD x 1/4" Deep, for 8" ID pans (19.7 x 24.1 x 0.6 cm, for 20.3 cm pans) Cover only for 4008, 8008, 5008, 5108, Stacking Cover for DEP8, 2008, 9008 |
| 7009 | 8 3/4" ID x 10 1/2" OD x 1/4" Deep, for 9" ID pans (22.2 x 26.7 x 0.6 cm, for 22.9 cm pans) Cover only for 4009, 8009, 5009, 5109, Stacking Cover for DEP9, 2009, 9009 |
| 7010 | 9 3/4" ID x 11 1/2" OD x 1/4" Deep, for 10" ID pans (24.8 x 29.2 x 0.6 cm, for 25.4 cm pans) Cover only for 4010, 8010, 5010, 5110, Stacking Cover for DEP10, 2010, 9010 |
| 7011 | 10 3/4" ID x 12 1/2" OD x 1/4" Deep, for 11" ID pans (27.3 x 31.8 x 0.6 cm, for 27.9 cm pans) Cover only for 4011, 8011, 5011, 5111, Stacking Cover for DEP11, 2011, 9011 |
| 7012 | 11 3/4" ID x 13 1/2" OD x 1/4" Deep, for 12" ID pans (29.8 x 34.3 x 0.6 cm, for 30.5 cm pans) Cover only for 4012, 8012, 5012, 5112, Stacking Cover for DEP12, 2012, 9012 |
| 7013 | 12 3/4" ID x 14 1/2" OD x 1/4" Deep, for 13" ID pans (32.4 x 36.8 x 0.6 cm, for 33 cm pans) Cover only for 4013, 8013, 5013, 5113, Stacking Cover for DEP13, 2013, 9013 |
| 7014 | 13 3/4" ID x 15 1/2" OD x 1/4" Deep, for 14" ID pans (34.9 x 39.4 x 0.6 cm, for 35.6 cm pans) Cover only for 4014, 8014, 5014, 5114, Stacking Cover for DEP14, 2014, 9014 |
| 7015 | 14 3/4" ID x 16 1/2" OD x 1/4" Deep, for 15" ID pans (37.5 x 41.9 x 0.6 cm, for 38.1 cm pans) Cover only for 4015, 8015, 5015, 5115, Stacking Cover for DEP15, 2015, 9015 |
| 7016 | 15 3/4" ID x 17 1/2" OD x 1/4" Deep, for 16" ID pans (40 x 44.5 x 0.6 cm, for 40.6 cm pans) Cover only for 4016, 8016, 5016, 5116, Stacking Cover for DEP16, 2016, 9016 |
| 7017 | 16 3/4" ID x 18 1/2" OD x 1/4" Deep, for 17" ID pans (42.5 x 47 x 0.6 cm, for 43.2 cm pans) Cover only for 4017, 8017, 5017, 5117, Stacking Cover for DEP17, 2017, 9017 |
| 7018 | 17 3/4" ID x 19 1/2" OD x 1/4" Deep, for 18" ID pans (45.1 x 49.5 x 0.6 cm, for 45.7 cm pans) Cover only for 4018, 8018, 5018, 5118, Stacking Cover for DEP18, 2018, 9018 |

USA



7016



SQUARE DEEP DISH PANS USA

Crafted from heavy-weight 14-ga., 1.5 mm aluminum, these straight-sided square pans can be perforated with the same round pattern used on our Perf Discs on pg. 404. Hard Coat Anodized 14-ga., 1.5 mm Aluminum not shown.

PAN DEPTH 1" (2.5 CM)

Pan size

| | |
|-------------------|---------------|
| 6" Sq. (15.2 cm) | SQ610 |
| 8" Sq. (20.3 cm) | SQ810 |
| 10" Sq. (25.4 cm) | SQ1010 |
| 12" Sq. (30.5 cm) | SQ1210 |
| 14" Sq. (35.6 cm) | SQ1410 |
| 16" Sq. (40.6 cm) | SQ1610 |

Heavy-Weight
14-ga., 1.5 mm Aluminum

Hard Coat Anodized
14-ga., 1.5 mm Aluminum

| |
|-----------------|
| HCSQ610 |
| HCSQ810 |
| HCSQ1010 |
| HCSQ1210 |
| HCSQ1410 |
| HCSQ1610 |

PAN DEPTH 1 1/2" (3.8 CM)

Pan size

| | |
|-------------------|---------------|
| 6" Sq. (15.2 cm) | SQ615 |
| 8" Sq. (20.3 cm) | SQ815 |
| 10" Sq. (25.4 cm) | SQ1015 |
| 12" Sq. (30.5 cm) | SQ1215 |
| 14" Sq. (35.6 cm) | SQ1415 |
| 16" Sq. (40.6 cm) | SQ1615 |

| |
|-----------------|
| HCSQ615 |
| HCSQ815 |
| HCSQ1015 |
| HCSQ1215 |
| HCSQ1415 |
| HCSQ1615 |

PAN DEPTH 2" (5.1 CM)

Pan size

| | |
|-------------------|---------------|
| 6" Sq. (15.2 cm) | SQ620 |
| 8" Sq. (20.3 cm) | SQ820 |
| 10" Sq. (25.4 cm) | SQ1020 |
| 12" Sq. (30.5 cm) | SQ1220 |
| 14" Sq. (35.6 cm) | SQ1420 |
| 16" Sq. (40.6 cm) | SQ1620 |

| |
|-----------------|
| HCSQ620 |
| HCSQ820 |
| HCSQ1020 |
| HCSQ1220 |
| HCSQ1420 |
| HCSQ1620 |



SQUARE SEPARATORS USA

Use these heavy-weight 14-ga., 1.5 mm aluminum separators as serving pans or stackable covers for any of our Square Deep Dish Pans.

| | |
|---------------|--|
| SQ600 | 8 1/2" Sq. (21.6 cm) for 6" (15.2 cm) pan |
| SQ800 | 10 1/2" Sq. (26.7 cm) for 8" (20.3 cm) pan |
| SQ1000 | 12 1/2" Sq. (31.8 cm) for 10" (25.4 cm) pan |
| SQ1200 | 14 1/2" Sq. (36.8 cm) for 12" (30.5 cm) pan |
| SQ1400 | 16 1/2" Sq. (41.9 cm) for 14" (35.6 cm) pan |
| SQ1600 | 18 1/2" Sq. (47 cm) for 16" (40.6 cm) pan |

Rectangular Deep Dish Pans USA

Made of heavy-weight 14-ga. aluminum, these rectangular pizza pans are designed for specialty pizzas. Feed the entire party with its two-foot length and choice of depth.

Heavy-Weight **14-ga., 1.5 mm Aluminum**

| | |
|-----------------|--|
| TF122410 | 24" L x 12" W x 1" H (61 x 30.5 x 2.5 cm) |
| TF122415 | 24" L x 12" W x 1 1/2" H (61 x 30.5 x 3.8 cm) |
| TF122420 | 24" L x 12" W x 2" H (61 x 30.5 x 5.1 cm) |

Hard Coat Anodized **14-ga., 1.5 mm Aluminum**

| | |
|-------------------|---|
| HCTF122410 | 24" L x 12" W x 1" H (61 x 30.5 x 2.5 cm) (not shown) |
| HCTF122415 | 24" L x 12" W x 1 1/2" H (61 x 30.5 x 3.8 cm) (not shown) |
| HCTF122420 | 24" L x 12" W x 2" H (61 x 30.5 x 5.1 cm) (not shown) |

Rectangular Hard Coat Anodized Aluminum Long Pans

Create a decadent, crispy crust on 2-3 sides of each piece with these heavy-weight, hard coat aluminum long pizza pans. Creates 3-6 equal 4" cuts.

- HCLP12** 12" L x 4" W x 1 5/8" H
(30.5 x 10.2 x 4.1 cm)
- HCLP16** 16" L x 4" W x 1 5/8" H
(40.6 x 10.2 x 4.1 cm)
- HCLP24** 24" L x 4" W x 1 5/8" H
(61 x 10.2 x 4.1 cm)

Sicilian-Style Hard Coat Anodized Aluminum Pans

Now you can bake pizza just like Nonna used to make! Manufactured of heavy-duty hard coat aluminum, our Sicilian pizza pans are available in all the most popular square and rectangular sizes. The tapered 1" (2.5 cm) depth and crisp angled corners provide efficient cooking, easy clean-up and space-saving nestability for storage.

- HCSS12** 12" Sq. x 1" H
(30.5 x 2.5 cm)
- HCSS14** 14" Sq. x 1" H
(35.6 x 2.5 cm)
- HCSS16** 16" Sq. x 1" H
(40.6 x 2.5 cm)
- HCSS1411** 14" L x 10" W x 1" H
(35.6 x 25.4 x 2.5 cm)
- HCSS1812** 18" L x 12" W x 1" H
(45.7 x 30.5 x 2.5 cm)
- HCSS248** 24" L x 8" W x 1" H
(61 x 20.3 x 2.5 cm)
- HCSS2416** 24" L x 16" W x 1" H
(61 x 40.6 x 2.5 cm)

Detroit-Style Hard Coat Anodized Aluminum Pans

Detroit-style pizza lovers, rejoice! These extra-deep pans are the secret to baking Motown-worthy pies every time.

- HCDS108** 10" L x 8" W x 2 3/8" H
(25.4 x 20.3 x 6 cm)
- HCDS1410** 14" L x 10" W x 2 1/2" H
(35.6 x 25.4 x 6.4 cm)
- HCDS1712** 17" L x 12" W x 2 3/4" H
(43.2 x 30.5 x 7 cm)

Aluminium Lids

- DSP11** Fits HCDS108, 11 1/2" L x 9 1/2" W
(29.2 x 24.1 cm)
(not shown)
- DSP15** Fits HCDS1410, 15 1/2" L x 11 1/2" W
(39.4 x 29.2 cm)
- DSP18** Fits HCDS1712, 18 1/2" L x 13 1/2" W
(47 x 34.3 cm)

Flexible Server

Get to every bit of buttery crust with this dishwasher-safe server.

- FS9** 9" L x 4 1/4" W
(22.9 x 10.8 cm)



Shown with FS9 server, OWBB1 crate and CSC4CL sauce cup



HCDS1410 shown with DSP15 lid

HCDS1712 shown with DSP18 lid

FS9



Square Wide-Rim Pans

Our most popular pizza serving pans have gotten a makeover. These Square Wide-Rim Pizza Pans expertly serve up anything from Sicilian to Detroit-Style pizzas. Made of durable 18-gauge aluminum, these pans can also double as modern serving trays in dining halls and quick serve restaurants.

STP10 10" Sq. (25.4 cm)

STP12 12" Sq. (30.5 cm)

STP14 14" Sq. (35.6 cm)

STP16 16" Sq. (40.6 cm)

Coupe Collection Trays

Elegant yet simple, the Coupe Collection offers a level of subtle refinement to the tabletop. This satin-finished line of stainless steel dinnerware is a versatile (yet durable) suggestion in modern dining.

SSP4 4" Dia. x $\frac{3}{8}$ " H (10.2 x 1 cm)

SSP6 6" Dia. x $\frac{3}{8}$ " H (15.2 x 1 cm)

SSP8 8" Dia. x $\frac{3}{8}$ " H (20.3 x 1 cm)

SSP9 9" Dia. x $\frac{3}{8}$ " H (22.9 x 1 cm)

SSP10 10½" Dia. x $\frac{3}{8}$ " H (26.7 x 1 cm)

SSP12 12" Dia. x $\frac{3}{8}$ " H (30.5 x 1 cm)

SSP13 13" Dia. x $\frac{3}{8}$ " H (33 x 1 cm)

SSP14 14" Dia. x $\frac{3}{8}$ " H (35.6 x 1 cm)

SSP15 15" Dia. x $\frac{3}{8}$ " H (38.1 x 1 cm)

SSP16 16" Dia. x $\frac{3}{8}$ " H (40.6 x 1 cm)



FROM SMALLEST
TO LARGEST:

SSP4
SSP6
SSP8
SSP9
SSP10
SSP12
SSP13
SSP14
SSP15
SSP16

Onyx Galvanized Wide Rim Pans

The days of using a standard aluminum pan for serving are over. You now have options! These dark galvanized pans are perfect for serving up anything from pizza to burritos.

GTP10 10" Dia. x $\frac{3}{8}$ " H (25.4 x 1 cm)

GTP12 12" Dia. x $\frac{3}{8}$ " H (30.5 x 1 cm)

GTP14 14" Dia. x $\frac{3}{8}$ " H (35.6 x 1 cm)

GTP16 16" Dia. x $\frac{3}{8}$ " H (40.6 x 1 cm)

GTP18 18" Dia. x $\frac{3}{8}$ " H (45.7 x 1 cm)



FROM SMALLEST
TO LARGEST:

GTP10
GTP12
GTP14
GTP16
GTP18



Ceramic Pizza Trays

These ceramic trays add a touch of old-world charm to pizza presentation. Available in four sizes to fit most standard pizzas.

- CERAM12** 12" Dia. (30.5 cm)
- CERAM14** 14" Dia. (35.6 cm)
(not shown)
- CERAM16** 16" Dia. (40.6 cm)
- CERAM18** 18" Dia. (45.7 cm)

Melamine Pizza Plates

Serve up your favorite pie on these versatile, durable and dishwasher-safe melamine pizza plates. A sleek way to plate up any slice!

- MTP10** 10" Dia. x ¾" H (25.4 x 1.9 cm)
- MTP12** 12" Dia. x 1 ⅛" H (30.5 x 2.9 cm)
- MTP14** 14" Dia. x 1 ⅛" H (35.6 x 2.9 cm)
- MTP16** 16" Dia. x 1 ⅛" H (40.6 x 2.9 cm)
- MTP18** 18" Dia. x 1 ⅜" H (45.7 x 3.5 cm)



HOT



STONE13

CAN ALSO KEEP PIZZAS WARM
IN HEATED DISPLAY CASES

Ceramic Pizza Stones HOT Water Fire

These ceramic baking stones create a light, crispy crust by distributing heat evenly and efficiently.

STONE13 Round
13" Dia. x 3/8" H (33 x 1 cm)

STONE12 Rectangular
15" L x 12" W x 3/8" H (38.1 x 30.5 x 1 cm)

STONE15 Round
15" Dia. x 3/8" H (38.1 x 1 cm)

STONE14 Rectangular
15" L x 14" W x 3/8" H (38.1 x 35.6 x 1 cm)



STONE12



STONE15



STONE14

Nera Nano Enamel

Pizza Stones NEW

Our Nera Nano Enamel Pizza Stones are made with brand new technology. The result is a stone that looks and feels like cast iron but without the extra weight. Each stone is naturally non-stick, abrasion-resistant and able to withstand high oven temperatures.

PSB16 Round
16" Dia. x 3/8" H
(40.6 x 1 cm)

PSB1416 Rectangular
16" L x 14" W x 3/8" H
(40.6 x 35.6 x 1 cm)

Deluxe Pizza Stones

Perfect for spaces where hearth baking isn't possible, these stones are designed with ideal thickness and porosity for heat retention. Made of cordierite, a lead-free firebrick material.

PS125 Round
12 1/2" Dia. x 3/8" H
(31.8 x 1 cm) (not shown)

PS1575 Round
15 3/4" Dia. x 7/8" H
(40 cm x 2.2 cm)

PSS12 Square
12" Sq. x 1/4" H
(30.5 x 0.6 cm) (not shown)

PS115 Square
15" Sq. x 1/2" H
(38.1 x 1.3 cm)

PS1116 Rectangular
16" L x 11" W x 3/4" H
(40.6 x 27.9 x 1.9 cm)

PS1416 Rectangular
16" L x 14" W x 7/8" H
(40.6 x 35.6 x 2.2 cm)



Shown with PSA105 server and SCAW7 caddy



PS1116 shown with ADH10 dredge and BEE319 shaker



PS1416



PS1575



PSS15



Standard Dough Box ^{USA}

Tough ABS construction with reinforced sides, corners and edges. Stacks securely. Dishwasher-safe.

DRB18230 18" L x 26" W x 3" H
(45.7 x 66 x 7.6 cm)

DRBC1826 Cover for Dough Pan
18 1/4" L x 26 1/4" W x 3/4" H
(46.4 x 66.7 x 1.9 cm)



Heavy-Duty Dough Box ^{USA}

Our premium dough boxes are manufactured from tough Teflon® copolymer for the ultimate in non-stick. Cross-stack lugs enable fast and secure cross-stacking. Interchangeable with most other dough boxes.

DBP1826 18" L x 26" W x 3 1/8" H
(45.7 x 66 x 7.9 cm)

Deluxe Anodized Aluminum Dough Pans ^{USA}

Constructed from heavy-weight 14-ga., 1.5 mm tempered aluminum in a secure, self-stacking design for easy storage. Cleans easily and refrigerates quickly. Eastern pan stacks with pans of similar shape.

Small Straight-Sided Stacking ^{USA}

DRPS5725 7 7/8" OD x 7" ID x 2 1/2" H
(20 x 17.8 x 6.4 cm) 32 oz. (0.9 L) capacity

7007 Cover for DRPS5725
8 1/4" Dia. x 1/4" H (21 x 0.6 cm)

DRPS5825 8 5/8" OD x 8" ID x 2 1/2" H
(21.9 x 20.3 x 6.4 cm) 40 oz. (1.2 L) capacity

7008 Cover for DRPS5825
9 3/8" Dia. x 1/4" H (23.8 x 0.6 cm)

Standard Straight-Sided Stacking ^{USA}

DRP774 7 7/8" OD x 7 1/4" ID x 2 1/2" H
(20 x 18.4 x 6.4 cm) 40 oz. (1.2 L) capacity

7007 Cover for DRP774
8 1/4" Dia. x 1/4" H (21 x 0.6 cm)

DRP884 9" OD x 8 3/8" ID x 3 3/8" H
(22.9 x 21.3 x 8.6 cm) 80 oz. (2.4 L) capacity

7008E Cover for DRP884
9 3/8" Dia. x 1/4" H (23.8 x 0.6 cm)

Eastern Stacking

DRPE800 8 1/4" OD x 7 1/2" ID x 2 5/8" H
(21 x 19.1 x 6.7 cm) 48 oz. (1.41 L) capacity

7007E Cover for DRPE800
8 1/2" Dia. x 1/4" H (21.6 x 0.6 cm)

DRPE878 8 7/8" OD x 8 1/4" ID x 3" H
(22.5 x 20.9 x 7.6 cm) 96 oz. (2.8 L) capacity

7008E Cover for DRPE878
9 3/8" Dia. x 1/4" H (23.8 x 0.6 cm)



Rolling Pins and Pie Rollers

Whatever your preferred style of roller is, American Metalcraft has you covered.

- PR18** Wood
1 1/4" Dia. x 18" L
(3.2 x 45.7 cm)
- PRP500** Stainless Steel
1 3/4" Dia. x 5 1/2" W x 8 3/4" L
(4.4 x 14 x 22.2 cm)
- WRPC5713** Wood
13" L (33 cm)
(not shown)
- RP5718** Aluminum
18" L (45.7 cm)
- WRPC5715** Wood
15" L (38.1 cm)
(not shown)
- WRPC5718** Wood
18" L (45.7 cm)
- WRPCHARDWARE** 2 Extra Handles each,
Stainless Steel End Caps
and Nylon Bearings for wood
rolling pins



Dough Cutters and Scrapers

Features stainless steel blade and wood or plastic handle.

- DS6704** Wood Handle
6" W x 4 1/2" H (15.2 x 11.4 cm)
- DS6706** Wood Handle
6" W x 6" H (15.2 x 15.2 cm)
- DSP6705** Plastic Handle
6" W x 4 1/2" H (15.2 x 11.4 cm)

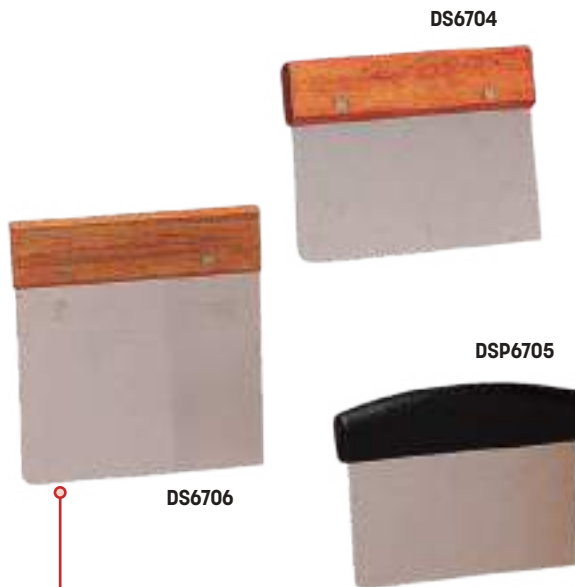

ROUNDED CORNER SCRAPES CLEAN
WITHOUT EXCESSIVE SCRATCHING

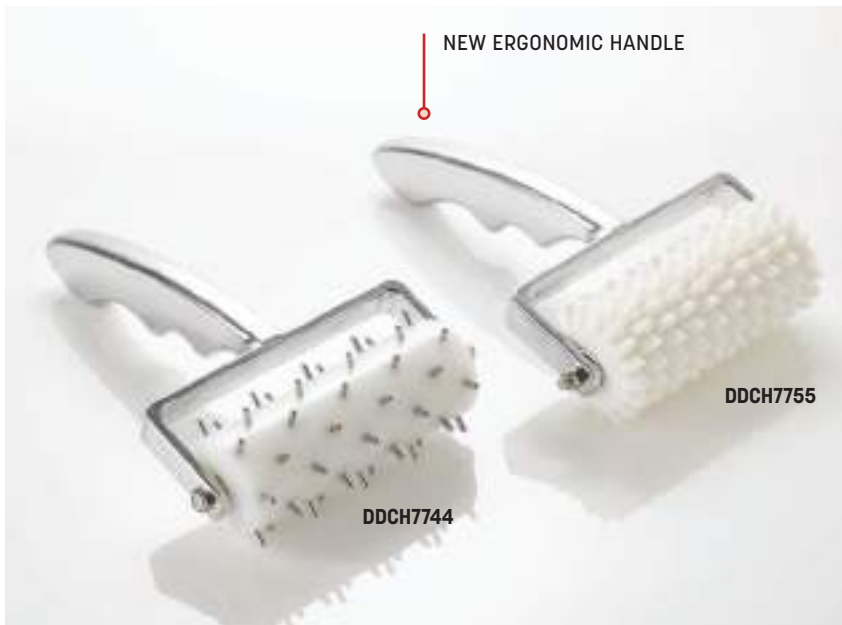

Heavy-Duty Plastic Roller Dockers

Individual wheels with plastic points spin independently on a stainless steel axle.

DD5274 Half-Size Plastic Docker
Plastic Handle
3 1/2" W x 8 3/4" L (8.9 x 22.2 cm)

DD5705 Full-Size Plastic Docker
Aluminum Handle
5 1/2" W x 8 3/4" L (14 x 22.2 cm)

DDW5705 Replacement Wheel

Ten-Wheel Casted Handle Dough Docker

Features a one-piece, heavy-duty cast aluminum ergonomic handle and interchangeable ten-piece plastic wheel base.

DDCH7755 6 1/4" W x 9 1/4" L (15.9 x 23.5 cm)

DDW5705 Replacement Wheel

Casted Handle Dough Docker

One-piece cast aluminum ergonomic handle for great durability. Features 3/8" (1 cm) stainless steel pins embedded in plastic roller.

DDCH7744 6 1/4" W x 9 1/4" L (15.9 x 23.5 cm)



All-Plastic Dough Docker

One-piece plastic core features 3/8" (1.6 cm) long pins. Dishwasher-safe.

DD5701 Plastic Docker

Heavy-Duty Roller Dockers

Stainless steel pins are permanently embedded in a plastic core. Crafted with stainless steel axle and sanitary solid aluminum handle.

DD5275 Half-Size Plastic Docker
2 3/4" W x 1 3/4" Dia. Barrel
(7 x 4.4 cm)

DD5704 Full-Size Plastic Docker
5" W x 1 3/4" Dia. Barrel
(12.7 x 4.4 cm)



Long-Pin Docker

Unit made with two sets of interlocking plastic pins.

DD5703 Plastic Pin Docker 7/8" L Pins (2.2 cm)
3 1/2" W x 8 1/2" Overall
(8.9 x 21.6 cm)

DDW5703 Replacement Wheel

Super Heavy-Duty Pan Grippers

An extra-durable stainless steel alternative to our standard Pan Grippers, these pieces are 50% heavier. Use HDD94 with shallow pans such as our CAR, DEP and 4000 Series. Use HDS95 with our 3800, 5000, 5100, 8000 and 9000 Series pans.

HDD94 For Shallow Pans

HDS95 For Deep Pans



Pan Grippers

Cast Aluminum Pan Gripper

Reinforced bottom curves provide better grip. Spring-loaded for easy release of pan. Designed for use with DEP, 3800, 4000, 5000, 5100, 8000 and 9000 Series pans.

G9595 8 1/8" L (20.6 cm)

Nylon Pan Gripper

Dishwasher-safe, high-heat-resistant. Designed for use with DEP, 3800, 4000, 5000, 5100, 8000 and 9000 Series pans.

N9494 8 1/4" L (21 cm)

Nickel-Plated Pan Grippers

Crafted from heavy-tempered steel. Use 9525 with shallow pans such as our CAR, DEP and 4000 Series. Use I9540 with our 3800, 5000, 5100, 8000 and 9000 Series pans.

9525 For Shallow Pans

I9540 For Deep Pans



50% HEAVIER THAN STANDARD PAN GRIPPERS



HPP16



HPP7

Heart-Shaped Aluminum Pizza Pans

These playful pans aren't just for pizza. Share the love with cakes, brownies and oversized cookies too.

HPP7 7" W x 1 1/2" Deep (17.8 x 3.8 cm)

HPP16 16" W x 1 1/2" Deep (40.6 x 3.8 cm)

Mini Stainless Steel Number Tents

Made of dishwasher-safe, high-heat-resistant stainless steel, these double-sided embossed number tents make table service easy as pie. 1" Sq. x 1 1/2" W (2.5 x 3.8 cm).

EM199 Nos. 1-99

EM1200 Nos. 1-200

EM200 Nos. 201-400

EM400 Nos. 401-600



EM199

Loft Collection Acacia Wood Shaker Caddy

Stylishly bring the condiments to the table with this beautifully designed caddy from the Loft Collection. Made of intricately grained Acacia wood, this caddy includes three holders for a trio of shakers or loose condiments. And the smart inset design allows for a solid fit for most 6 to 12 oz. shakers. Knockdown handle also allows for smart shipping and storage.

SCAW7 Fits Most 6 oz. (177.4 mL) to 12 oz. (354.9 mL) Shakers
7" L x 6 1/2" W x 8 5/8" H
(17.8 x 16.5 x 21.9 cm)



SCAW7

Shown with GLADT6, 3307 and BEE319 shakers



FITS AN ASSORTMENT OF SHAKERS DUE TO BUILT-IN LEDGE



USE TO CREATE A FRESH CONDIMENT STATION

SHAKER TOPS AND BOTTOMS

With glass bodies and a variety of stainless steel tops, these shakers feature eye-catching contemporary designs.

2 oz. Glass Contemporary Shakers

Measures 2" Dia. x 3 1/8" H (5.1 x 7.9 cm).

GLACT2 Shaker with Cheese Top

GLAST2 Shaker with Slotted Top

GLADT2 Shaker with Adjustable Dial Top

GLBASE Shaker Base Only

2 oz. Replacement Tops

CT2 Cheese Round Holes

ST2 Spice Slotted

DT2 Adjustable Dial Top

CAP2 Plastic Cover for Top

6 oz. Glass Contemporary Shakers

Measures 2 3/8" Dia. x 4 1/2" H (6 x 11.4 cm).

4406 Shaker with Cheese Top

4407 Shaker with Slotted Top

GLADT6 Shaker with Adjustable Dial Top

GLA600 Shaker Base Only

6 oz. Replacement Tops

4406T Cheese Round Holes

4407T Spice Slotted

DT6 Adjustable Dial Top

CAP25 Plastic Cover for Top

6 oz. Vintage Collection Square Glass Shakers

Part of our Vintage Collection, these cheese and spice shakers feature stainless steel caps and are dishwasher-safe. Each 6 oz. (177.4 mL) shaker measures 2 5/8" Sq. x 3 3/4" H (6.7 x 9.5 cm).

GSC6 Shaker with Cheese Top

GSS6 Shaker with Slotted Top

GSD6 Shaker with Adjustable Dial Top



CHECK OUT OUR MATCHING VINTAGE S&P SHAKERS ON PG. 151



6 oz. Swirl Jar Shakers

Our take on classic pizzeria styling. 6 oz. (177.4 mL) capacity. 2 5/8" Dia. x 3 1/2" H (6.7 x 8.9 cm).

Glass

- 3306 Shaker with Cheese Top
- 3307 Shaker with Spice Top

PET

- LX306 Shaker with Cheese Top (not shown)
- LX307 Shaker with Spice Top (not shown)

Replacement Shaker Tops

6 oz. and 8 oz. Tops

- 3307T Small Spice Slotted
- 3306T Cheese with Small Round Holes

12 oz. Tops

- 3312T Cheese with Large Round Holes
- 3316T Sugar Flap Top
- 3317T Spice Slotted
- 3319T Cheese with Extra Large Holes
- 3318T Dredge with Small Round Holes



8 oz. Glass Shakers

Ideal for condiments such as red pepper, oregano and parmesan cheese. 8 oz. (236.6 mL) capacity. 2 3/4" Dia. x 3 7/8" H (7 x 9.9 cm).

- 3308 Shaker with Cheese Top
- 3309 Shaker with Spice Top



Mini Glass Shakers and Caddy

This stainless steel rack and its matching glass shakers are a fraction of the size of regular shakers.

MGLA3 Base, 2 oz. (59.1 mL)
1 5/8" Dia. x 3 5/8" H
(4.1 x 9.2 cm)

MCADDY Caddy
4 1/2" L x 2 1/4" W x 5 1/2" H
(11.4 x 5.7 x 14 cm)

MGLCS Set
 (Includes Caddy with Cheese and Spice Shakers)

Replacement Mini Lids

- M30SP** Salt and Pepper
- M312T** Cheese
- M316T** Sugar Flap Top
- M317T** Spice



MINIATURE DESIGN IS EXTRA EASY TO CARRY

6 oz. Glass Beehive Shakers

This 6 oz. (177.4 mL) beehive shaker features a charming pear-shaped design.
2" Dia. x 3 1/2" H (5.1 x 8.9 cm)

- BEE606** Shaker with Cheese Top
- BEE607** Shaker with Spice Top
- BEE600** Shaker Base Only



12 oz. Glass Beehive Shakers

These stylishly ridged beehive shakers measure 3" Dia. x 5 3/8" H (7.6 x 13.7 cm).

- BEE312** Shaker with Cheese Top
- BEE316** Shaker with Sugar Flap Top
- BEE317** Shaker with Spice Top
- BEE318** Shaker with Dredge Top
- BEE319** Shaker with Extra Large Holes Cheese Top
- BEE300** Shaker Base Only



PAIR WITH OTHER PIECES FROM OUR BEEHIVE LINE (PG. 148)



12 oz. Classic Shakers

These 12 oz. (354.9 mL) capacity shakers have a standard straight-sided fluted shape and are stain-proof and dishwasher-safe. The SAN plastic shakers are nearly indestructible. 3" Dia. x 5 3/8" H (7.6 x 13.7 cm).

Glass

- GLA312** Shaker with Cheese Top
- GLA316** Shaker with Sugar Flap Top
- GLA317** Shaker with Spice Top
- GLA318** Shaker with Dredge Top
- GLA319** Shaker with Extra Large 1/4" Holes Cheese Top
- GLA300** Shaker Base Only

SAN Plastic

- SAN312** Shaker with Cheese Top
- SAN316** Shaker with Sugar Flap Top
- SAN317** Shaker with Spice Top
- SAN318** Shaker with Dredge Top
- SAN319** Shaker with Extra Large 1/4" Holes Cheese Top
- SAN300** Shaker Base Only



12 oz. Tapered Plastic Shakers

These shakers feature heavy-duty plastic bases and stainless steel tops. Odorless and dishwasher-safe. 3" Dia. x 5 3/8" H (7.6 x 13.7 cm).

- 3312** Shaker with Cheese Top
- 3316** Shaker with Sugar Flap Top
- 3317** Shaker with Spice Top
- 3318** Shaker with Dredge Top
- 3319** Shaker with Extra Large 1/4" Holes Cheese Top
- 3300** Shaker Base Only

16 oz. Stainless Steel Shakers

In cool brushed stainless steel, these shakers feature fine or coarse holes for different seasonings. 16 oz. (473.2 mL) capacity. 3" Dia. x 7" H (7.6 x 17.8 cm).

- TSF7** Shaker with Fine Holes
- TSC7** Shaker with Coarse Holes





Square Pizza Paper

In your choice of three classic styles.
1000 16" (40.6 cm) sheets per pack.

- PPRW1616** White
- PPCH4N** Natural
- PPRN1616** Newspaper

Jumbo Stainless Steel Soup Cans

Whether you use them as risers or condiment holders, these rustic cans offer versatile solutions with a memorable twist.

- CSM40** 40 oz. (1.2 L)
6 ¼" Dia. x 3" H (15.9 x 7.6 cm)
- CSM2** 2 qt. (1.9 L)
5 ¼" Dia. x 6" H (13.3 x 15.2 cm)
- CSM3** 3 ¼ qt. (3.1 L)
6 ¼" Dia. x 7" H (15.9 x 17.8 cm)



CSM2 shown with
OWP13 olive wood peel

CSM40 shown with
4406 and GLADT6 shakers



SDRCK4 shown with TP14 tray and MGLA3 shakers

SDRCK shown with TP14 tray and BEE312 and BEE317 shakers



Shown with 3218 wood peel and BEE319 shakers

BUS309

BUS312

Round Pizza Stands

SDRCK4 7 1/2" Top Dia. x 9 5/8" Bottom Dia. x 4" H (19.1 x 24.4 x 10.2 cm)

SDRCK 7 1/2" Top Dia. x 9 5/8" Bottom Dia. x 7 3/8" H (19.1 x 24.4 x 18.7 cm)

Universal Pizza Stands

Black

BUS309 9" L x 8" W x 7" H (22.9 x 20.3 x 17.8 cm)

BUS312 12" Sq. x 7" H (30.5 x 17.8 cm)

Chrome-Plated

190039 9" L x 8" W x 7" H (22.9 x 20.3 x 17.8 cm)

1900312 12" Sq. x 7" H (30.5 x 17.8 cm) (not shown)



190039 shown with HC5016 pan



Shown with PC7400 pizza cutter and 4407 shaker

LWUS779

SSUS1

LWUSR shown with TP12 pan

Contempo™ Swirl Pizza Stands

These stylishly versatile stands can be flipped over to accommodate different sizes of trays.

- LWUSR** Red
7" Top Dia. x 9" Bottom Dia. x 6 3/8" H
(17.8 x 22.9 x 16.2 cm)
- LWUS779** Black
7 1/8" Top Dia. x 9" Bottom Dia. x 7" H
(18.1 x 22.9 x 17.8 cm)
- SSUS1** Stainless Steel
7 1/4" Top Dia. x 9" Bottom Dia. x 6 3/4" H
(18.4 x 22.9 x 17.1 cm)

Geometric Pizza Stands

Pizzas are center of the stage when served on our Geometric Pizza Stands. Available in multiple color options, these 7" stands can be paired with any one of our many wood boards or peels to create a truly showstopping look.

- RGS7** Stainless Steel
7" Dia. x 7" H (17.8 x 17.8 cm)
- RGG7** Gold
7" Dia. x 7" H (17.8 x 17.8 cm)
- RGB7** Black
7" Dia. x 7" H (17.8 x 17.8 cm)



Shown with MWP13 plate and 4407 shaker

RGS7

RGB7

RGG7

Shaker Caddy Attachments

Ingeniously transport and serve cheese and spice options for every pizza with our expertly designed Shaker Caddy Attachments. Designed to fit on the bottom of many popular pizza stands, these attachments will hold most 6 to 12 oz. shakers. These essential accessories turn any pizza stand into a shaker caddy!

- SCAR9** Rectangular Attachment
9 5/8" L x 3 1/2" W x 2 3/8" H
(24.4 x 8.9 x 6 cm)
Fits Stands 190039, RSB312, RSRB7
Holds most 6 oz. (177.4 mL) to 12 oz. (354.9 mL) Shakers
- SCAT9** Triangular Attachment
9 1/4" L x 8 1/4" W x 1 3/4" H
(23.5 x 21 x 4.4 cm)
Fits Stands SDRCK, RSRB, RSR10
Holds most 6 oz. (177.4 mL) to 12 oz. (354.9 mL) Shakers



SCAR9 shown with 190039 stand and GLA312, GLA317 shakers

SCAT9 shown with SDRCK stand and 3308, 3309 shakers



SCAR9



SCAT9



RSRBH7

RSRBH4

Loft Collection Rubberized Hairpin Stands

The newest additions to our black rubberized stands, these risers boast unique hairpin curved legs with an added rubberized texture to keep things in place. No more sliding pizzas!

RSRBH4 9" Dia. x 4" H (22.9 x 10.2 cm)

RSRBH7 9" Dia. x 7" H (22.9 x 17.8 cm)

Rubberized Universal Stands

Our stylishly minimalist pizza stands, now wrapped in slide-resistant rubber. What's not to love?

Red

RSR312 9" L x 8 3/4" W x 7" H (22.9 x 22.2 x 17.8 cm)

RSR307 12" Sq. x 7" H (30.5 x 17.8 cm)

Black

RSB312 9" L x 8 3/4" W x 7" H (22.9 x 22.2 x 17.8 cm)

RSB307 12" Sq. x 7" H (30.5 x 17.8 cm)

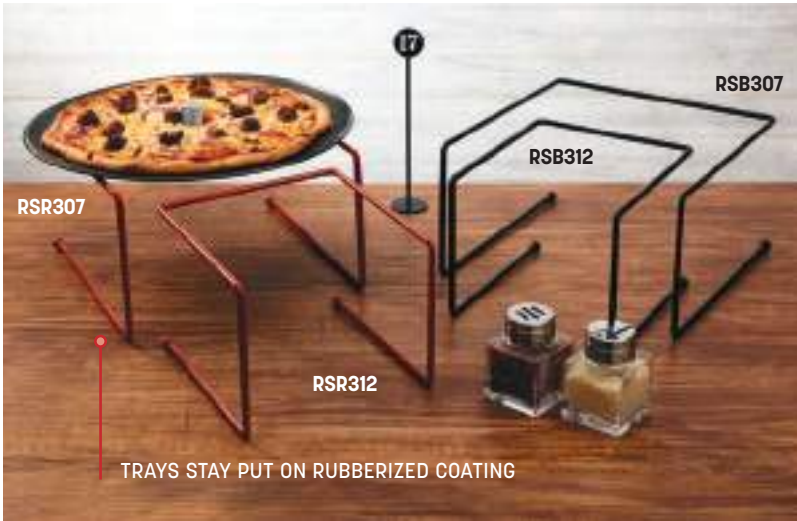

RSR307

RSB307

RSB312

RSR312

TRAYS STAY PUT ON RUBBERIZED COATING

Black Rubberized Stands

Tired of tracking down rubber stoppers to keep your pizza pans in place? These ingenious stands have the rubber built in. Plus, each of these contemporary wire-frame designs are reversible.

Round

RSRB4 7 1/2" Dia. Top x 9 5/8" Bottom Dia. x 4" H (19.1 x 24.4 x 10.2 cm)

RSRB 7 1/2" Dia. Top x 9 5/8" Bottom Dia. x 7 3/8" H (19.1 x 24.4 x 18.7 cm)

RSR10 8 3/8" Dia. Top x 9 7/8" Bottom Dia. x 11 3/4" H (21.3 x 25.1 x 29.8 cm)

Rectangular

RSRB3 9" L x 6" W Top x 11" L x 8" W Bottom x 3 1/2" H (22.9 x 15.2 x 27.9 x 20.3 x 8.9 cm)

RSRB7 9" L x 6" W Top x 11" L x 8" W Bottom x 7" H (22.9 x 15.2 x 27.9 x 20.3 x 17.8 cm)

Square

RSSB3 7" Sq. Top x 9" Sq. Bottom x 3 1/2" H (17.8 x 22.9 x 8.9 cm)

RSSB7 7" Sq. Top x 9" Sq. Bottom x 7" H (17.8 x 22.9 x 17.8 cm)



RSR10

RSRB

RSRB4

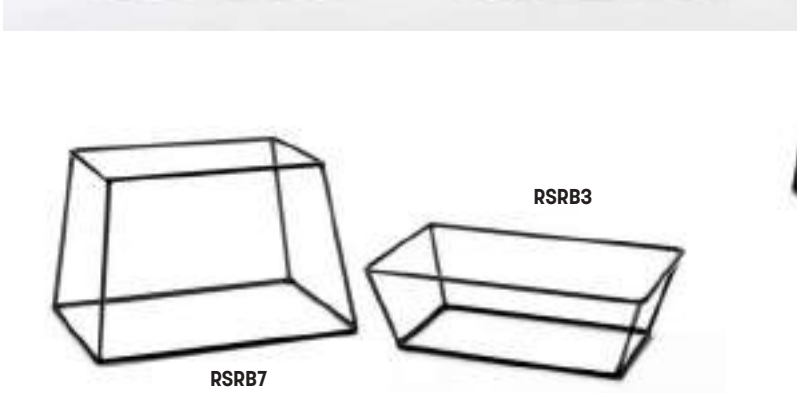

RSRB7

RSRB3

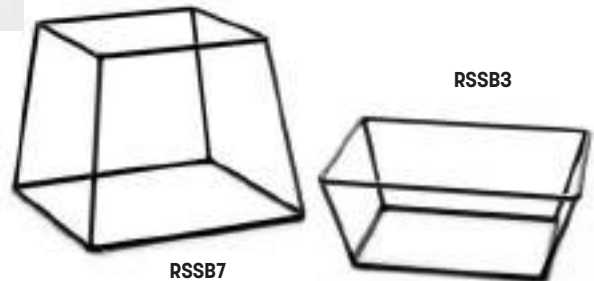

RSSB7

RSSB3

Loft Collection Rustic Iron Stand  

Finally a pizza stand equally as cool as the pizzas it displays. Made of black iron with a rustic finish, this 7" high stand stylishly saves space on the table while allowing space for condiments underneath. Pair with your favorite wood serving board from the Loft Collection to complete the vibe.

PSR7 9" Dia. x 7" H
(22.9 x 17.8 cm)

Ironworks Pizza Stands 

DPS797 Drum
7" Top Dia. x 9" Bottom Dia. x 7" H
(17.8 x 22.9 x 17.8 cm)

PSS77 Black Square Scroll
7" Sq. x 9" H (17.8 x 22.9 cm)

Black Iron Pizza Stand 

Serve two pizzas at a time without taking up valuable table space with this two-tiered piece from our Ironworks Collection.

TLSP1219 19 3/8" L x 11 3/4" W x 12 3/8" H
(49.2 x 29.8 x 31.4 cm)



Shown with ATP14 serving board

PSR7



PSS77 shown with HA5012 pan

DPS797 shown with TP14 pan



DESIGNED FOR MINIMAL FOOTPRINT

TLSP1219 shown with TP15 pan



Heavy-Duty Pizza Servers

Pizza anyone? These heavy-duty stainless steel servers are able to stand up to your largest slice. The perforated server even doubles as a cheese grater for a little extra topping.

PSG127 Perforated Server/Grater
7" L x 4 3/4" W Blade, 12 1/8" L Overall
(17.8 x 12.1, 30.8 cm)

PS127 Server
7" L x 4 3/4" W Blade, 12 1/8" L Overall
(17.8 x 12.1, 30.8 cm)

Mini Pizza Peels

The ideal size for personal pizzas and oven-baked subs. These heavy-duty stainless steel peels are strong enough to hold your heaviest pie. Perfect for conveyor ovens.

PL147 Stainless Steel
7 1/4" W x 9 5/8" L Blade, 14 3/4" L Overall
(18.4 x 24.4, 37.5 cm)

PLP147 Perforated Stainless Steel
7 1/4" W x 9 5/8" L Blade, 14 3/4" L Overall
(18.4 x 24.4, 37.5 cm)



Pizza Scissors/Turner

Pizza-lovers, rejoice! These innovative server-scissors can both cut and serve even the heartiest deep-dish pies. With a rubberized handle for comfortable grip and detachable construction for easy cleaning, this is a must-have tool for pizzerias across the globe.

PSD10 10 5/8" L x 3 1/2" W x 3/4" H
(27 x 8.9 x 1.9 cm)

Pizza Servers

Each of these practical tools features a stainless steel blade, perfect for both square- and triangle-sliced pizzas.

19006 Stainless Steel Pizza Server with Wood Handle
5" L x 2 1/2" W Blade, 10 1/2" Overall
(12.7 x 6.4, 26.7 cm)

PS10 Stainless Steel Turner with Plastic Handle
3 5/8" L x 1 7/8" W Blade, 10" Overall
(9.2 x 4.8, 25.4 cm)

PS196 Stainless Steel Pizza Server with Dark Brown Handle
5" L x 2 1/2" W Blade, 10 1/2" Overall
(12.7 x 6.4, 26.7 cm)



Plastic-Handled Pizza Cutters

Heavy-duty one-piece molded plastic handles, stainless steel wheels.

PPC2 2 ¾" Dia. Wheel with Black Handle (7 cm)

PCW2 Blade for PPC2

PPC4 4" Dia. Wheel with Black Handle (10.2 cm)

PIZW1 4" Dia. Wheel with White Handle (10.2 cm)

PIZR2 4" Dia. Wheel with Red Handle (10.2 cm)

PIZG3 4" Dia. Wheel with Green Handle (10.2 cm)

PCW4 Blade for PPC4, PIZW1, PIZR2, PIZG3

PPC5 5" Dia. Wheel with Black Handle (12.7 cm)

PCW5 Blade for PPC5

PPCHARDWARE Replacement Axel Assembly, with Screw Bushing and Lock Nut



Aluminum-Handled Pizza Cutter

Simple and classic, this cutter features a heavy cast aluminum handle with a stainless steel wheel.

APC2 2 ¾" Dia. Wheel (6.7 cm)



Wood-Handled Pizza Cutters

Features sanitary stainless steel wheels, rust-proof guards and wooden handles.

PC7250 2 ½" Dia. Wheel (6.4 cm)

PC7400 4" Dia. Wheel (10.2 cm)



Loft Collection Acacia Wood-Handled Accessories

Pizza serving utensils that now offer form, function and beauty. The Loft Collection pizza cutter and server are designed to sit proudly on the table with their beautiful Acacia wood handles and durable stainless steel finish.

Pizza Cutter

PCA3 3 ½" Dia. Wheel (8.9 cm)

Pizza Server

PSA105 5 ½" L x 2 ¾" W Blade, 10 ¾" Overall (14 x 6, 27.3 cm)





Pizza Knives

These full-tang knives feature stainless steel blades and double handles so you can cut safely and confidently.

PPK17 POM Handle
18" L Blade (45.7 cm)

PWK19 Wood Handle
18" L Blade (45.7 cm)

Pizza Rocker Knives

In addition to cutting pizzas, these stainless steel blades can be used to chop ingredients.

PRS14 13 3/4" L x 3 1/2" H (34.9 x 8.9 cm)

PRS22 22" L x 5 1/8" H (55.9 x 13 cm)

PKR20 20" L x 4 3/4" H Blade
21 1/2" L Overall with Handles
(50.8 x 12.1, 54.6 cm)

Multi-Wheel Cutter

Take the guesswork out of slicing with this adjustable six-bladed cutter. Measures 2 1/2" x 9 1/2" (6.4 x 24.1 cm) when closed, and 24 1/2" x 9 1/2" (62.2 x 24.1 cm) when open. Distance between 2" parallel wheels can range from 3/4" to 4 3/4" (1.9 x 12.1 cm).

MWPC6X2 Six-Blade Cutter



MWPC6X2

ALSO USEFUL FOR EVENLY SLICING PASTRY DOUGH

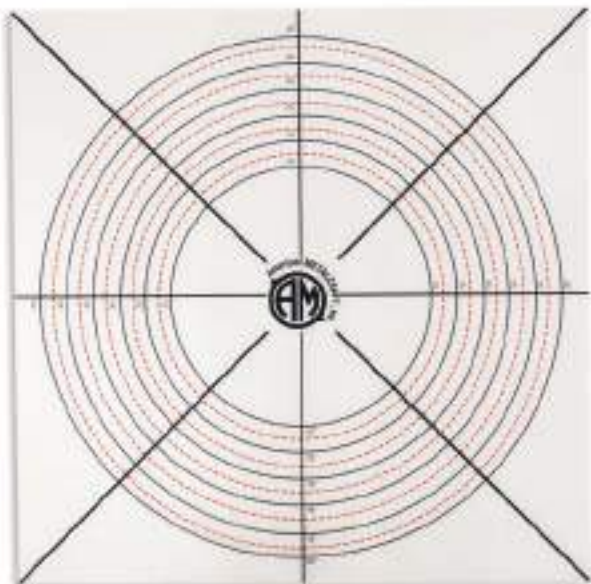

MPNS



MPCUT4

Non-Slip Pizza Cutting Mat

MPNS 22" Sq. x 1/8" H (55.9 x 0.32 cm)

Pizza Slice Cutting Guide

Made of natural pressed wood fiber material, these durable and dishwasher-safe cutting boards have laser-cut grooves that make cutting evenly-sized pizza slices a breeze.

MPCUT4 Board with Markings for 4-Slice or 8-Slice
20" Sq. x 1/4" H (50.8 x 0.6 cm)

MPCUT6 Board with Markings for 6-Slice
20" Sq. x 1/4" H (50.8 x 0.6 cm)
(not shown)

Pizza Bubble Poppers

Choose from wood, all-aluminum and red rubber grips.

SBP30 Red Rubber Grip
30" L (76.2 cm)

BP39 Wood Handle
39" L (99 cm)

19009 Aluminum
43" L (109.2 cm)

BP51 Wood Handle
51" L (129.5 cm)

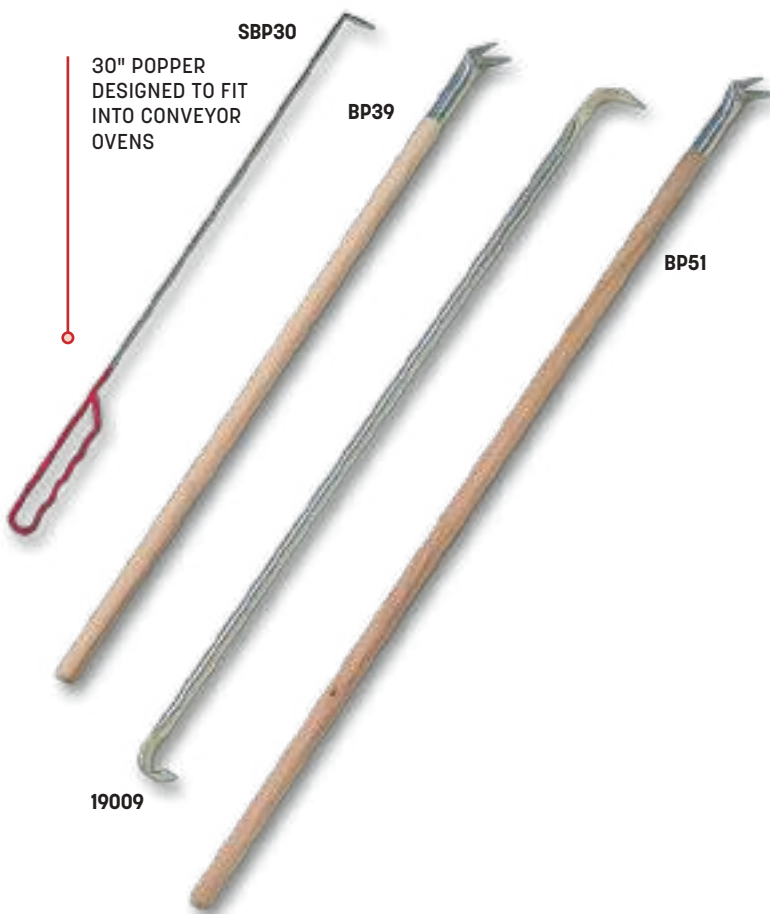



19029
shown with
HCDEP12 and
TP12 pans

19030
shown with
ADEP12 and
HCDEP12 pans

19033
shown with
HC90182 and
HA2018 pans

19024
shown with
18712, and
18717 pizza
screens



19107

Shown with (3)
18714 pizza screens

Pizza Racks

- 19030** Standard for Pans up to 2 ¼" (5.7 cm) Deep
10" - 17" (25.4 - 43.2 cm) Dia.
11 Shelves with 2 ½" (6.4 cm) between with 12" (30.5 cm) Base
- 19029** Standard for Pans up to 1 ¼" (3.2 cm) Deep
10" - 17" (25.4 - 43.2 cm) Dia.
15 Shelves with 1 ⅜" (3.5 cm) between with 12" (30.5 cm) Base

- 19024** Standard for Pans up to ½" (1.5 cm) Deep
10" - 17" (25.4 - 43.2 cm) Dia.
24 Shelves with ¾" (1.9 cm) between with 12" (30.5 cm) Base
- 19033** Over Sized for Pans up to 2 ¼" (5.7 cm) Deep
16" - 23" (40.6 - 58.4 cm) Dia.
10 Shelves with 2 ½" (6.4 cm) between with 16" (40.6 cm) Base

Wall-Mounted Pizza Rack

- 19107** Wall-Mountable with Seven Tiers
12" L x 10" W x 15" H
(30.5 x 25.4 x 38.1 cm)
- 19104** 4 Brackets and 8 Screws for 19107

Deluxe Small All-Aluminum Peels 

12" (30.5 cm) Square Blade

| | |
|---------|------------------------|
| ITP1213 | 27" Overall (68.6 cm) |
| ITP1222 | 37" Overall (94 cm) |
| ITP1238 | 52" Overall (132.1 cm) |
| ITP1246 | 60" Overall (152.4 cm) |

Deluxe Medium All-Aluminum Peels 

14 1/2" (36.8 cm) Square Blade

| | |
|---------|----------------------------|
| ITP1413 | 30" Overall (76.2 cm) |
| ITP1422 | 39" Overall (99.1 cm) |
| ITP1438 | 55 1/2" Overall (141 cm) |
| ITP1446 | 63 1/2" Overall (161.3 cm) |

Deluxe Large All-Aluminum Peels 

17 1/2" x 18 1/2" (44.5 x 47 cm) Blade

| | |
|---------|----------------------------|
| ITP1713 | 34" Overall (86.4 cm) |
| ITP1722 | 43" Overall (109.2 cm) |
| ITP1738 | 59 1/2" Overall (151.1 cm) |
| ITP1746 | 68" Overall (172.7 cm) |

Deluxe Extra Large All-Aluminum Peels 

19 1/2" x 21" (49.5 x 53.3 cm) Blade

| | |
|---------|----------------------------|
| ITP1913 | 37" Overall (94 cm) |
| ITP1922 | 45 1/2" Overall (115.6 cm) |
| ITP1938 | 62" Overall (157.5 cm) |
| ITP1946 | 67 3/4" Overall (172.1 cm) |

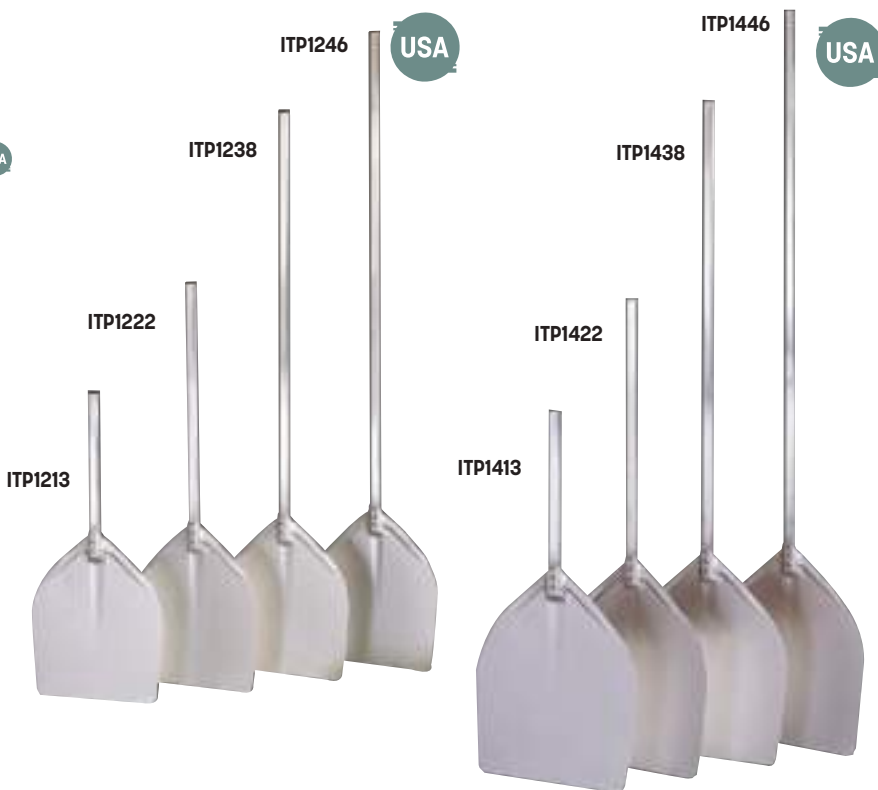

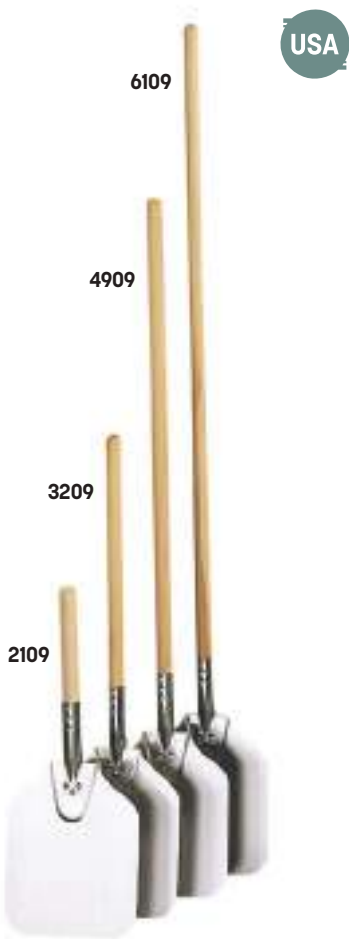

ALUMINUM PEELS CAN BE PERFORATED TO REDUCE RESISTANCE AND WEIGHT



Aluminum Small Blade Peels 

- 9" x 11" (22.9 x 28 cm) Blade
- 2109** 21" L Overall (53.3 cm)
- 3209** 32 ½" L Overall (82.6 cm)
- 4909** 49" L Overall (124.5 cm)
- 6109** 61" L Overall (155 cm)

Aluminum Medium Blade Peels 

- 12" x 14" (30.5 x 35.6 cm) Blade
- 2512** 26" L Overall (66 cm)
- 3512** 35 ½" L Overall (90.2 cm)
- 5212** 52" L Overall (132.1 cm)
- 6412** 64" L Overall (162.6 cm)

Aluminum Large Blade Peels 

- 14" x 16" (35.6 x 40.6 cm) Blade
- 2814** 28" L Overall (71.1 cm)
- 3714** 37" L Overall (94 cm)
- 5414** 54" L Overall (137.2 cm)
- 6614** 66" L Overall (167.6 cm)

Aluminum Extra Large Blade Peels 

- 16" x 18" (40.6 x 45.7 cm) Blade
- 3016** 30" L Overall (76.2 cm)
- 4016** 39 ½" L Overall (100.3 cm)
- 5616** 56" L Overall (142.2 cm)
- 6816** 68" L Overall (172.7 cm)

Aluminum Round Blade Peels 

- 17080** 8" Dia. x 20" L Blade Overall (20.3 x 50.8 cm)
- 17135** 13 ½" Dia. x 35" L Blade Overall (34.3 x 88.9 cm)
- 17160** 16" Dia. x 38" L Blade Overall (40.6 x 96.5 cm)



Perf P For pricing, visit amnow.com

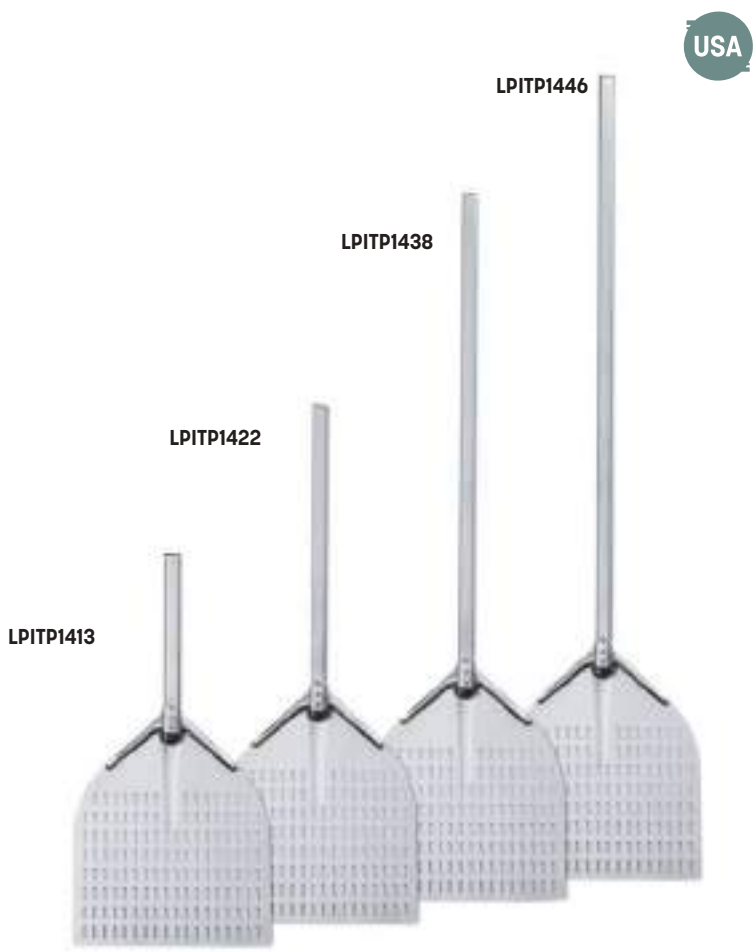

Stainless Steel Perforated Pizza Peels NEW USA

Perfect for high heat ovens, these perforated pizza peels make it easy to move pizzas in, out and around ovens. The perforations reduce resistance and weight, allowing for even quicker transfers. Available in multiple long handle lengths. 8" (20.3 cm) Diameter Blade.

- PPSS837 45 3/4" L Overall (116.2 cm)
- PPSS849 57 3/4" L Overall (146.7 cm)

Linear Perforated All-Aluminum Pizza Peels USA

Safely move pizzas in and around a piping hot oven. Linear perforation helps with easier transfer. 14 1/2" (36.8 cm) Square Blade.

- LPITP1413 30" L Overall (76.2 cm)
- LPITP1422 39" L Overall (99.1 cm)
- LPITP1438 55 1/2" L Overall (141 cm)
- LPITP1446 63 1/2" L Overall (161.3 cm)

Small All-Aluminum Peel USA

- 674 Blade
6 3/4" x 7 3/4", 20 1/2" L Overall
(17.1 x 19.7, 52.1 cm)



Chrome-on-Steel Peel Rack USA

- WPH45153 4 5/8" W x 1 1/4" D x 3" H
(11.7 x 3.2 x 7.6 cm)



Deluxe Wood Make-Up Peel 

32" L (81.3 cm) Overall

3218 Blade 18" W x 17 1/2" L (45.7 x 44.5 cm)

Deluxe Wood Blade 

36" L (91.4 cm) Overall

3612 Blade 12" W x 13" L (30.5 x 33 cm)

3614 Blade 14" W x 15" L (35.6 x 38.1 cm)

3616 Blade 16" W x 17" L (40.6 x 43.2 cm)

42" L (106.7 cm) Overall

4212 Blade 12" W x 13" L (30.5 x 33 cm)

4214 Blade 14" W x 15" L (35.6 x 38.1 cm)

4216 Blade 16" W x 17" L (40.6 x 43.2 cm)

4218 Blade 18" W x 18" L (45.7 x 45.7 cm)

4220 Blade 20" W x 21" L (50.8 x 53.3 cm)



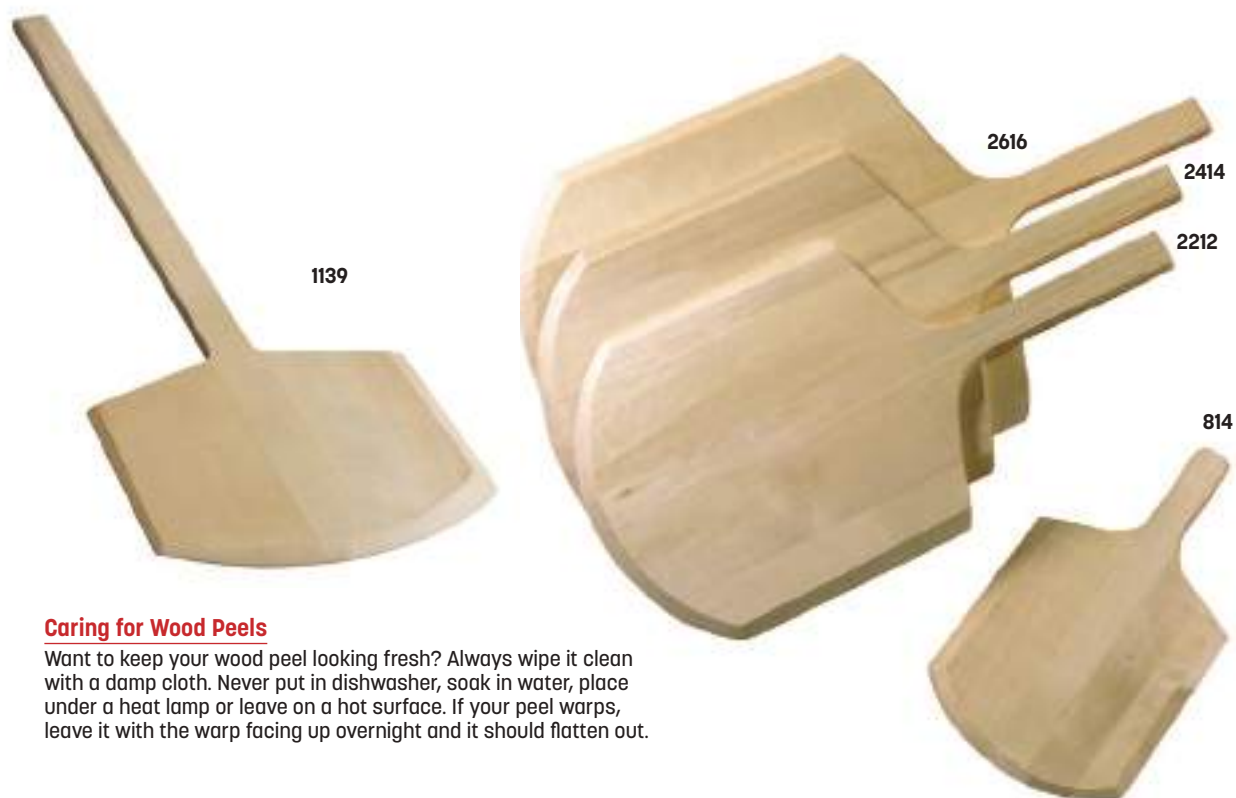

Caring for Wood Peels

Want to keep your wood peel looking fresh? Always wipe it clean with a damp cloth. Never put in dishwasher, soak in water, place under a heat lamp or leave on a hot surface. If your peel warps, leave it with the warp facing up overnight and it should flatten out.

Deluxe Wood Blade Short Handle

- 814 8" W x 9" L Blade, 14" L Overall
(20.3 x 22.9, 35.6 cm)
- 2212 12" W x 13" L Blade, 22" L Overall
(30.5 x 33, 55.9 cm)
- 2414 14" W x 15" L Blade, 24" L Overall
(35.6 x 38.1, 60.1 cm)
- 2616 16" W x 17" L Blade, 26" L Overall
(40.6 x 43.2, 66 cm)

Deluxe Wood Square Blade – 39" L (99.1 cm) Overall

- 1139 Blade, 11" Sq. (27.9 cm)

Deluxe Wood Long Blade – 6 1/2" L (16.5 cm) Handle

36" L (91.4 cm) Overall

- 836 Blade 8" W x 29 1/2" L (20.3 x 74.9 cm)
- 1636 Blade 16" W x 29 1/2" L (40.6 x 74.9 cm)
- 1836 Blade 18" W x 29 1/2" L (45.7 x 74.9 cm)

42" L (106.7 cm) Overall

- 1842 Blade 18" W x 36" L (45.7 x 91.4 cm)
- 2242 Blade 22" W x 36" L (55.9 x 91.4 cm)

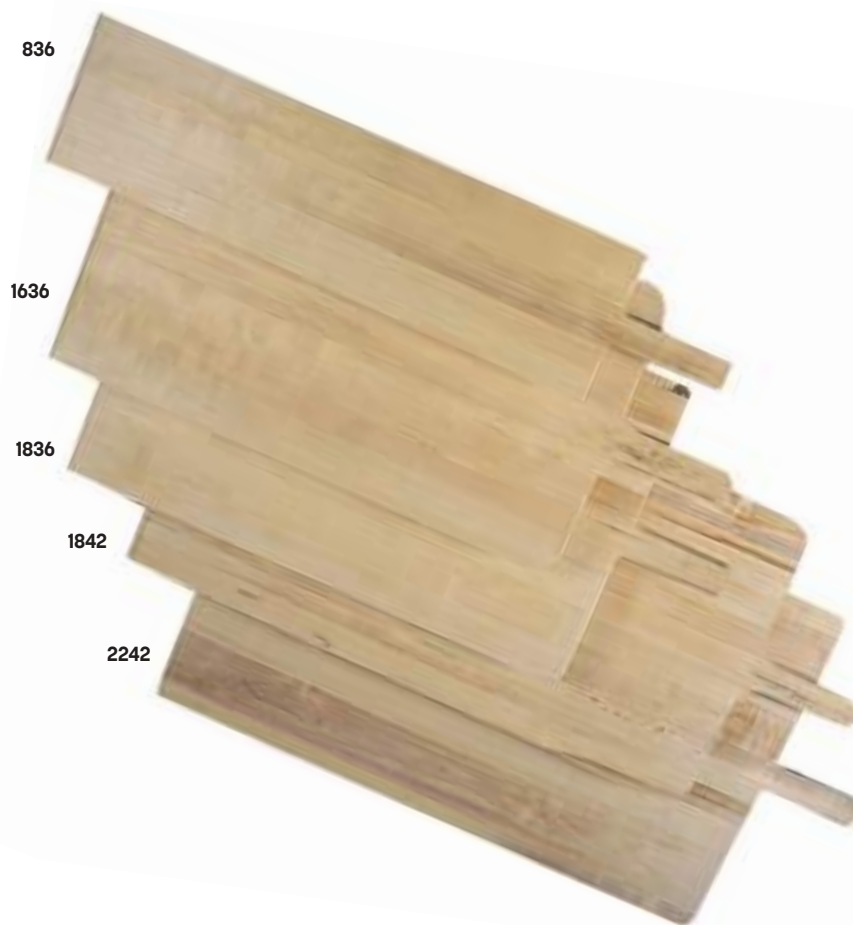

Shown with RSRBH7 and RSRBH4 stands



ATP14

ATP12

ATP16

SERVING BOARDS
ARE REVERSIBLE

ATP10



OWP17

OWP15

OWP13

OWP9

Loft Collection Acacia Wood Serving Boards

Plate up anything from pizzas to charcuterie in these beautifully grained wood boards. Made of durable Acacia wood, each board is double-sided for versatility in serving. Pair with risers and accessories from the Loft Collection for a complete look.

ATP10 10" Dia. x 5/8" H (25.4 x 1.6 cm)

ATP12 12" Dia. x 5/8" H (30.5 x 1.6 cm)

ATP14 14" Dia. x 5/8" H (35.6 x 1.6 cm)

ATP16 16" Dia. x 5/8" H (40.6 x 1.6 cm)

Short Handle Olive Wood Serving Peels

Featuring rich wood grains, our olive wood boards and peels give any tabletop an extra dimension. These pieces are exceptionally unique—no two are alike.

OWP9 8" W x 9" L Blade, 14" Overall
(20.3 x 22.9, 35.6 cm)

OWP13 12" W x 13" L Blade, 22" Overall
(30.5 x 33, 55.9 cm)

OWP15 14" W x 15" L Blade, 24" Overall
(35.6 x 38.1, 61 cm)

OWP17 16" W x 17" L Blade, 26" Overall
(40.6 x 43.2, 66 cm)

Maple Pressed Wood

Serving Boards USA

A beautiful maple veneer gives these boards the look and feel of wood, but with the ease of being dishwasher-safe.

MBSB11 11" L x 7" W x ¼" H
(27.9 x 17.8 x 0.6 cm)

MBSB17 17" L x 9" W x ¼" H
(43.2 x 22.9 x 0.6 cm)

MBSB20 19" L x 9" W x ¼" H
(48.3 x 22.9 x 0.6 cm)

Black Pressed Wood

Serving Boards

Made of natural wood fiber material, this black serving board is the perfect companion to our Mega Flatbread Screens

MPSB16 16" L x 8" W x ¼" H
(40.6 x 20.3 x 0.6 cm)



USA



MBM4 shown with GJ6 jar



MBM4

MBM3

MBM2

USA

**Maple Pressed Wood
Serving Peels** USA

These presentation-worthy peels feature a beautiful maple veneer that's both food- and dishwasher-safe. Though we designed them for pizzas, they can also be used to serve appetizers, sandwiches and more.

Rectangular

MBM2 12 1/2" L x 4 3/8" W x 1/4" H, 18" L Overall
(31.8 x 11.1 x 0.6, 45.7 cm)

MBM3 12 1/2" L x 6 1/2" W x 1/4" H, 18" L Overall
(31.8 x 16.5 x 0.6, 45.7 cm)

MBM4 13" L x 8 1/8" W x 1/4" H, 18" L Overall
(33 x 20.6 x 0.6, 45.7 cm)

Round

MBM180 18" Dia. x 1/4" H, 28 1/2" L Overall
(45.7 x 0.6, 72.4 cm)



MBM180

USA

PRESSED WOOD PEELS

Made of natural wood fiber material, these durable, dishwasher-safe pressed wood peels overcome the objections health departments may have with traditional wood peels and boards.

**Round Pressed Wood Pizza Peels
5" L (12.7 cm) Handle**

- MP1116 11" Dia. (27.9 cm)
- MP1217 12" Dia. (30.5 cm)
- MP1318 13" Dia. (33 cm)
- MP1419 14" Dia. (35.6 cm)
- MP1520 15" Dia. (38.1 cm)
- MP1621 16" Dia. (40.6 cm)
- MP1722 17" Dia. (43.2 cm)
- MP1823 18" Dia. (45.7 cm)



MP1116

Pressed Wood Pizza Peels

- MP1222 Blade
12" L x 14" W, 22" L with Handle
(30.5 x 35.6, 55.9 cm)
- MP1424 Blade
14" L x 16" W, 24" L with Handle
(35.6 x 40.6, 61 cm)
- MP1626 Blade
16" L x 17" W, 26" L with Handle
(40.6 x 43.2, 66 cm)



MP1116 MP1318 MP1520 MP1722
MP1217 MP1419 MP1621 MP1823

Make-Up Pressed Wood Pizza Peel

- MP1826 18" Sq. Blade, 26" L with Handle
(45.7, 66 cm)



MP1826

USA



MP1424

MP1222

MP1626



BLDX2005

BLDX1805



BLB1914

BLB1926

Deluxe Pizza Delivery Bags

With the golden age of food delivery upon us, we're proud to present our most advanced pizza bags to date. Featuring durable, abrasion-and mildew-resistant material and superior insulation. Plus, they're easy to clean.

- BLDX1805** 18" Sq. x 5" H
(45.7 x 12.7 cm)
Holds (2) 16" (40.6 cm) Pizza Boxes
- BLDX2005** 20" Sq. x 5" H
(50.8 x 12.7 cm)
Holds (2) 18" (45.7 cm) Pizza Boxes

Deluxe Delivery Bags with Rack

Features heavy-duty crossing straps for comfortable carrying. Perfect for carrying multiple pizzas.

With Rack

- BLB1914** 19 ½" Sq. x 14 ½" H
(49.5 x 36.8 cm)
Holds up to 6 Pizza Boxes
- BLB1926** 19" Sq. x 27" H
(48.3 x 68.6 cm)
Holds up to 10 Pizza Boxes

Bag Only

- BLBAG19** 19 ½" Sq. x 14 ½" H
(49.5 x 36.8 cm)
Holds up to 6 Pizza Boxes
- BLBAG26** 19" Sq. x 27" H
(48.3 x 68.6 cm)
Holds up to 10 Pizza Boxes



Deluxe Delivery Bags

These bags feature rust-proof iron grommets for steam ventilation. The perfect sizes for carry out containers and even grocery delivery.

BLDB1212 12 ½" Sq. x 12" H
(31.8 x 30.5 cm)

BLDB2412 24 ¾" L x 12 ½" W x 12" H
(62.9 x 31.8 x 30.5 cm)

Deluxe Sandwich Delivery Bag

This bag features rust-proof iron grommets for steam ventilation.

BLSB1512 15" L x 9" W x 12" H
(38.1 x 22.9 x 30.5 cm)



Deluxe Catering Delivery Bag

This satchel fits both full- and half-size food pans, making it the prime solution for delivering pastas, salads and other family-style feasts. Features easy-carry straps and an insulated interior as well as adjustable shelves and a reinforced frame.

BLDB2216 22" L x 13" W x 16" H
(55.9 x 33 x 40.6 cm)





PBDX2005

PBDX1805

Pizza Delivery Bags

With heavy nylon construction and reinforced stitching, these durable bags can hold two pizza boxes at a time. Contains PVC foam to keep pies oven-fresh.

- PBDX1805** 18" Sq. x 5" H
(45.7 x 12.7 cm)
Holds (2) 16" (40.6 cm) Pizza Boxes
- PBDX2005** 20" Sq. x 5" H
(50.8 x 12.7 cm)
Holds (2) 18" (45.7 cm) Pizza Boxes

Delivery Bags with Rack

The heavy nylon construction, reinforced stitching and insulating PVC foam from our Pizza Delivery Bags, supersized. Includes racks and features a two-handled strap for carrying.

With Rack

- PB1914** 19 1/2" Sq. x 14 1/2" H
(49.5 x 36.8 cm)
Holds up to 6 Pizza Boxes
- PB1926** 19" Sq. x 27" H
(48.3 x 68.6 cm)
Holds up to 10 Pizza Boxes

Bag Only

- PBBAG19** 19 1/2" Sq. x 14 1/2" H
(49.5 x 36.8 cm)
Holds up to 6 Pizza Boxes
- PBBAG26** 19" Sq. x 27" H
(48.3 x 68.6 cm)
Holds up to 10 Pizza Boxes



PB1926

PB1914

Sandwich Delivery Bag

Nine tiny grommet holes let this bag breathe, making it ideal for sandwich deliveries or picnics.

- PBSB1512** 15" L x 9" W x 12" H
(38.1 x 22.9 x 30.5 cm)



PBSB1512

Stirring Paddles

Stainless Steel Paddles

These seamless stainless steel paddles feature a 4 3/4" x 9 3/4" (12.1 x 24.8 cm) blade and 1" (2.5 cm) wide tubular handle. Available in multiple lengths.

- 2124 24" L (61 cm)
- 2130 30" L (76.2 cm)
(not shown)
- 2136 36" L (91.4 cm)
(not shown)
- 2142 42" L (106.7 cm)
(not shown)
- 2148 48" L (121.9 cm)
(not shown)
- 2154 54" L (137.2 cm)
(not shown)

Hard Wood Stirring Paddles

Smooth-sanded hardwood with a rectangular tapered blade. Blade measures 4" wide x 7/8" thick (10.2 x 2.2 cm). Handles measure 1 1/4" (3.2 cm) wide and are available in multiple lengths.

- 240 24" L (61 cm)
- 300 30" L (76.2 cm)
(not shown)
- 360 36" L (91.4 cm)
(not shown)
- 420 42" L (106.7 cm)
(not shown)
- 480 48" L (121.9 cm)
(not shown)



Pizza Oven Brush with Brass Bristles and Steel Scraper

Heavily filled (65 tufts) stiff brass wire on one side and a rust-proof steel scraper on the other. Screw-on handle with extra-strong die cast aluminum threaded tip for easy attachment to 10" x 1 3/4" (25.4 x 4.4 cm) hardwood block.

- 1597 Complete Brush and 40" Handle (101.6 cm)
- 1698 Complete Brush and 60" Handle (152.4 cm)
- 1597H Replacement Brush Only
- 159740 Handle Only 40" (101.6 cm)
- 159760 Handle Only 60" (152.4 cm)



IS13 shown with three
MWME21 platters



IS18 shown with three
MEL19 platters



Pairing Suggestions for Creative Presentations

Throughout the catalog, we pair various bowls, trays, platters and baskets in wood, bamboo, ceramic, porcelain, melamine, glass and stainless steel with our stands and risers. We even have flight boards that fit glass bottles. Please use the list below to make your own pairings for gorgeous, one-of-a-kind presentations.

TTREC3 shown with
three MEL19 platters



RECTANGULAR & SQUARE STANDS

| IS13 Stand Fits | IS18 Stand Fits | TTREC3 Stand Fits |
|------------------|-----------------|-------------------|
| AWMEL21.....216 | AWMEL19.....216 | AWMEL19.....216 |
| BAM211.....246 | BAM14.....246 | BAM14.....246 |
| BAM22.....246 | BAM148.....246 | BAM148.....246 |
| BG2113.....207 | BG159.....207 | BG159.....207 |
| CER21.....199 | CER19.....199 | CER19.....199 |
| CRGT21.....208 | CRGT21.....208 | CRGT21.....208 |
| FSLT21.....231 | FSLT08.....231 | FSLT08.....231 |
| FSLW21.....230 | FSLW08.....230 | FSLW08.....230 |
| FSMEL21.....232 | FSMEL19.....232 | FSMEL19.....232 |
| HMRT1322.....265 | HMRT814.....265 | HMRT814.....265 |
| MEL21.....215 | MEL148.....214 | MEL148.....214 |
| MEL2113.....214 | MEL19.....215 | MEL19.....215 |
| MWMEL21.....233 | MWMEL19.....233 | MWMEL19.....233 |
| WMEL21.....242 | RTWVY1.....199 | RTWVY1.....199 |
| | WMEL19.....242 | WMEL19.....242 |

ROUND STANDS

| TLSP1219 Stand Fits | TTRS3 Stand Fits |
|---------------------|------------------|
| CER7.....200 | CER7.....200 |
| GBG14.....207 | HMRD12.....264 |
| GBB15.....207 | MEL7.....212 |
| HMRD12.....264 | WSBM11.....206 |
| MEL7.....212 | |
| WSBM11.....206 | |
| WSBL15.....206 | |
| WSP15.....206 | |

TTRS3 shown
with three
MEL7 bowls





RISERS

ARB3 Risers Fit

| | |
|----------------|-----|
| AWMSQ73 | 216 |
| AWMSQ94 | 216 |
| AWMSQ117 | 216 |
| BAM73 | 247 |
| BAM94 | 247 |
| BAM124 | 247 |
| CRGSQ73 | 208 |
| CRGSQ94 | 208 |
| CRGSQ117 | 208 |
| FSMEL73 | 231 |
| FSMEL94 | 231 |
| FSMEL117 | 231 |
| FSWME73 | 230 |
| FSWME94 | 230 |
| FSWME117 | 230 |
| MELSQ73 | 210 |
| MELSQ94 | 210 |
| MELSQ117 | 210 |
| MWMSQ7 | 233 |
| MWMSQ9 | 233 |
| MWMSQ11 | 233 |
| SSQ73 | 267 |
| SSQ94 | 267 |
| SSQ117 | 267 |
| SSQH73 | 267 |
| SSQH94 | 267 |
| SSQH117 | 267 |
| TWBB73 | 243 |
| TWBB94 | 243 |
| TWBB117 | 243 |

AWR10 Risers Fit

| | |
|----------------|-----|
| AWMEL19 | 216 |
| AWMEL21 | 216 |
| AWMEL23 | 216 |
| BAM14 | 246 |
| BAM18 | 246 |
| BAM22 | 246 |
| CER19 | 199 |
| CER21 | 199 |
| CER23 | 199 |
| CRGT19 | 208 |
| CRGT21 | 208 |
| CRGT23 | 208 |
| FSMEL19 | 232 |
| FSMEL21 | 232 |
| FSMEL23 | 232 |
| HMRT814 | 265 |
| HMRT1019 | 265 |
| HMRT1322 | 265 |
| MEL19 | 215 |
| MEL21 | 215 |
| MEL23 | 215 |
| MWMEL19 | 233 |
| MWMEL21 | 233 |
| MWMEL23 | 233 |
| WMEL19 | 242 |
| WMEL21 | 242 |
| WMEL23 | 242 |

BRT1 Riser Fits

| | |
|-------------|-----|
| AB189 | 257 |
| AB249 | 257 |
| AB329 | 257 |
| MW18 | 234 |
| MW24 | 234 |
| MW32 | 234 |
| MWP18 | 251 |
| MWP24 | 251 |
| MWP32 | 251 |

BRT2 Riser Fits

| | |
|-------------|-----|
| AB189 | 257 |
| AB249 | 257 |
| AB329 | 257 |
| MW18 | 234 |
| MW24 | 234 |
| MW32 | 234 |
| MWP18 | 251 |
| MWP24 | 251 |
| MWP32 | 251 |

BRT3 Riser Fits

| | |
|-------------|-----|
| AB189 | 257 |
| AB249 | 257 |
| AB329 | 257 |
| MW18 | 234 |
| MW24 | 234 |
| MW32 | 234 |
| MWP18 | 251 |
| MWP24 | 251 |
| MWP32 | 251 |

ARCH STAND

TASSM Stand Fits

| | |
|---------------|-----|
| AWMSQ53 | 216 |
| BAM53 | 247 |
| CRGSQ53 | 208 |
| FSMEL53 | 231 |
| FSWME53 | 230 |
| GJ24 | 65 |
| MELSQ53 | 210 |
| MSJ4 | 64 |
| MWMSQ5 | 233 |
| SQVY4 | 133 |
| SSQ53 | 267 |
| SSQH53 | 267 |
| TWBB53 | 243 |
| WCBA4 | 299 |
| WCBL4 | 301 |
| WCV4 | 131 |

TASMED Stand Fits

| | |
|---------------|-----|
| AWMSQ94 | 216 |
| BAM94 | 247 |
| CRGSQ94 | 208 |
| FSMEL94 | 231 |
| MELSQ94 | 210 |
| MWMSQ9 | 233 |
| SSQ94 | 267 |
| SSQH94 | 267 |
| TWBB94 | 243 |

TASLG Stand Fits

| | |
|---------------|-----|
| AWMEL19 | 216 |
| AWMSQ73 | 216 |
| BAM14 | 246 |
| BAM73 | 247 |
| BG159 | 207 |
| CER19 | 199 |
| CRGSQ73 | 208 |
| CRGT19 | 208 |
| FSLT08 | 231 |
| FSLW08 | 230 |
| FSMEL19 | 232 |
| FSMEL73 | 231 |
| FSWME53 | 230 |
| HMRT814 | 265 |
| MEL148 | 214 |
| MEL19 | 215 |
| MELSQ73 | 210 |
| MWMEL19 | 233 |
| MWMSQ7 | 233 |
| RTWVY1 | 199 |
| SSQ73 | 267 |
| SSQH73 | 267 |
| TWBB73 | 243 |
| WMEL19 | 242 |

MERCHANDISING RISERS

BRR6 and BRR9 Fit

| | |
|----------------|-----|
| BR15 (1) | 287 |
| GJ40 (3) | 65 |
| MSJ5 (3) | 64 |



BRR9 shown with
BR15 riser and
(3) GJ40 jars

BRR6 shown with
BR15 riser and
(3) GJ40 jars

CONDIMENT RACKS

| BR15 Fits | BR126 Fits | BR128 Fits | BTS2 Fits | BWC12 Fits |
|----------------|----------------|-----------------|-----------------|-----------------|
| GJ40 (3) | GJ8 (8) | GJ24 (6) | GJ24 (6) | GJ24 (3) |
| MSJ5 (3) | MSJ3 (8) | MSJ4 (6) | MSJ4 (6) | MSJ4 (3) |
| | | WCBA4 (6) | WCBA4 (6) | WCBA4 (3) |
| | | WCBL4 (6) | WCBL4 (6) | WCBL4 (3) |
| | | WCV4 (6) | WCV4 (6) | WCV4 (3) |

POLYCARBONATE DOMES

| LFTD3 Fits | LFTD4 Fits | LFTD8 Fits | LFTD11 Fits | LFTD12 Fits | LFTD135 Fits |
|------------|------------|---------------|---------------|---------------|--------------|
| MWP4 | MWP5 | ATP10 | ATP12 | ATP14 | MWP14 |
| | | LFTPW11 | LFTPW12 | LFTPW13 | |
| | | LFTPB11 | LFTPB12 | LFTPB13 | |
| | | MWP9 | MWP12 | MWP13 | |
| | | | PSP12 | | |



LFTD12 shown
with LFTPB13

LFTD8 shown
with LFTPB11

COVERED SOLUTIONS ROLL-TOP COVERS

| RCR13 Fits | RCR21 Fits | RCRD14 Fits |
|---------------|---------------|--------------|
| MREC13 | MREC21 | MRDB14 |
| MRECB13 | MRECB21 | MTP14 |
| MW1210 | MW2012 | |

CHAFFER FRAME ACCESSORIES

| CFKIT Fits |
|--------------|
| CF1 |
| KBC20 |
| KSMC20 |
| SCF2 |

STORAGE CONTAINER

| SCBL Fits |
|------------------|
| ADAGIORD18 |
| GOLDAGR18 |
| MACD3 |
| MESA91C |
| MESA91H |
| REVLRD20 |
| REVLRT26 |



RCR21 cover shown on
MREC21 platter

RCR13 cover shown on
MREC13 platter

RCRD14 cover shown on
MRDB14 bowl



BEVERAGE INSERTS

| <u>IBT65 Fits</u> | <u>IBT126 Fits</u> | <u>IBT125 Fits</u> | <u>IBT200 Fits</u> |
|-------------------|--------------------|--------------------|--------------------|
| BEVB556 303 | BEVB6612 303 | BEVDG129 302 | BEV1220 303 |
| BEVC655 303 | BEVC1266 303 | BEVG129 302 | BEV820 303 |
| BEVDG6 302 | BEVDG126 302 | BNRB129 301 | BEVDG20 302 |
| BEVG6 302 | BEVG126 302 | KBC10 174 | BEVG20 302 |
| BNRB6 301 | BNRB126 301 | KSMC10 174 | BNRB20 301 |
| KBC6 174 | KBC12 174 | | KBC20 174 |
| KSMC6 174 | KSMC12 174 | | KSMC20 174 |
| WTBA6 299 | WTBA12 299 | | WTBA20 299 |
| WTBL6 301 | WTBL12 301 | | WTBL20 301 |
| WTV6 300 | WTV12 300 | | WTV20 300 |



BWF3 shown with GMB8 glass milk bottles

FLIGHT BOARDS

| <u>BWF3 Fits</u> | <u>BWF4 Fits</u> |
|------------------|------------------|
| GMB6 67 | GMB6 67 |
| GMB8 67 | GMB8 67 |

SHAKER CADDY ATTACHMENTS

| <u>SCAR9 Fits</u> | <u>SCAT9 Fits</u> |
|-------------------|-------------------|
| 190039 432 | RSR10 434 |
| RSB312 434 | RSRB 434 |
| RSRB7 434 | SDRCK 432 |

COLD CELL

| <u>COLD8 Fits</u> |
|--------------------|
| SBBL (2) 177 |
| SBBS 177 |
| WCVL (2) 300 |
| WCVS 300 |





CARE AND USE

Melamine Dinnerware and Serveware

This nearly indestructible line of melamine is long-lasting when cared for properly. It is not recommended for microwave use and should be washed only in a high-temperature dishwasher. Not for use with a heat lamp or in the oven. Regarding serving suggestions, we do not recommend any citric, acidic or strong-colored food products that would have direct contact with melamine. These products can cause staining over time. PET liners that can protect melamine from staining are available for some items.



Wrought Iron Griddles

Prior to using your American Metalcraft griddle for the first time, hand wash with a mild detergent and warm water. Then dry thoroughly with a soft cloth. Do not put wrought iron griddles in dishwashers or expose them to abrasive sponges, caustic cleaners or acidic detergents.

Wood Peels and Serving Boards

Wood pizza peels and serving boards should never be soaked in water, even for a few minutes. To clean, simply wipe down with a damp cloth and allow to air dry. They can be seasoned or sealed with oil. To seal, wipe any food-safe oil such as mineral oil on the surface of the peel or board. If sealed properly, the peel or board is less likely to pick up unwanted odors, food particles and moisture. If a peel or board warps, leave overnight with the warp facing up and it should flatten out. Avoid leaving peels or boards on hot surfaces. This increases the chance of warping.



Carbon and Black Steel Fry and Paella Pans

Seasoning is recommended. To season, wipe interior of pan with flavorless cooking oil and heat empty pan. When surface becomes hot, remove from heat and allow pan to cool. Repeat this process twice. Color of pan will change to a darker finish. This indicates that the pan has gained a natural non-stick protection.

To clean, hand wash in hot water with mild detergent. Dry with paper towel or place in warm oven for a few minutes. Re-season the pan when necessary to prevent food from sticking. Store in dry place. Do not put in dishwasher or expose to abrasive sponges or acidic detergents. Not suitable for microwave.

CAUTION: Handles are not heat-resistant.

Galvanized Pails and Tubs

To clean, hand wash in warm water with mild detergent and dry quickly. Do not put in dishwasher or expose to abrasive sponges, bristles, caustic cleaners or acidic detergents. Do not refrigerate, soak in water or use with acidic foods.



Hammered Copper

As beautiful as these lines are, they require special attention when cleaning. Please hand wash only with a soft cloth. Do not scour with steel wool or abrasive cleaners. Copper polish may be required to maintain the beauty of the surface.

Securit Signs

To erase Securit Original Chalk Marker messages on Table Boards, Mini Chalkboards, Wall Boards, Sandwich Boards and other Securit signage, wipe with a soapy cloth followed by a clean cloth.



Cast Iron

Before First Use

Hand wash and dry immediately. Rub with a thin, light coat of vegetable oil to restore sheen.

After First Use

Wash with hot water (and mild soap if necessary). Dry immediately and rub with a light coat of vegetable oil. To remove excess residue, use boiling water and a plastic scrub bun or brush. Dishwashing, acidic detergents and scouring pads/bristles are not recommended. Re-season the pan when necessary to prevent food from sticking.

Daily Care Notes

Never put cold water in a hot cast iron pan; this can cause the pan to crack or warp. Store in a cool and dry place. Gas flames should not extend up the sides of cast iron cookware. When deep frying, fill cast iron cookware only to 1/3 of capacity.



PIZZA PANS AND TRAYS

Aluminum Pans and Trays

Aluminum is a soft metal that is attacked by detergents with a high alkaline or acidic nature. Use detergents made specifically for aluminum. Through repeated use, aluminum will soften and, if scoured, will thin. Hand wash only using mild detergent made specifically for aluminum. Do not put in the dishwasher.



Tin Plate Pans

Tin plate should be seasoned before use and may need periodic re-seasoning. Tin plate will darken with use. Tin plate will also rust if refrigerated, soaked in water or left unseasoned in damp environments. Never soak in water or put in the dishwasher. Wipe dry immediately after hand washing.

To Season Tin Plate Pans

Wash in warm, soapy water and quickly dry. Brush oil on inside and outside surfaces of the pan and bake to a golden or dark brown. When seasoning, bake at regular times and temperatures. Some pans may need a second or third coating before being fully seasoned.



Hard Coat Pans

These pans are made from heavy-weight aluminum. Hard coat anodizing is a synergistic electro-chemical process that converts the surface of aluminum into aluminum oxide. The aluminum oxide is a dark color. The finish is hard and will not flake off. However, the aluminum underneath is soft and, through repeated use, the pan will soften. If scoured, the pan will thin. Hard coat pans are not non-stick and must be seasoned. Do not put these pans in dishwashers or expose them to caustic cleaning solutions. Hand wash only using mild detergent made specifically for aluminum.

To Season Hard Coat Pans

Wash and dry pans thoroughly. Wipe oil on the inside and outside surfaces of the pan and allow it to soak in for 30 minutes. Then, bake at regular cooking times and temperatures. Do not overbake and do not wash off excess oil. Just wipe clean. The oil residue and any additional oil added before baking makes the pan stick-resistant.



Pizza Stones

Pizza stones are freezer-, microwave- and oven-safe. They are not dishwasher-safe and require hand washing. Simply rinse in warm water before first use and allow the stone to dry thoroughly. It is recommended to preheat the stone 15-20 minutes for even cooking and to reduce baking time. To prevent cracking, avoid moving the stone between extreme temperatures such as from an oven to cold water. Allow the stone to cool completely before cleaning. To avoid a soapy aftertaste, do not use soap or detergents while cleaning. Simply remove baked-on foods and rinse in warm water. Do not soak or put in a dishwasher. Most stones will darken gradually and retain some staining with use. These are part of the stone's natural seasoning and will not affect the taste of the food. Handle each stone with care to prevent chipping or breaking.



TERMS AND CONDITIONS (2024 Catalog Effective 1/1/24)

COUNTRY OF ORIGIN  indicate products made in the United States of America.

LITERATURE Possession of our literature does not constitute an offer to sell.

PRINTING We are not responsible for printing errors.

© American Metalcraft, Inc. 2024. All Rights Reserved



| | | | | | | | |
|-------------|---------|------------|----------|----------------|-----|----------------|----------|
| 10SD..... | 383 | 2600..... | 307 | 7010..... | 415 | 18912SPHC..... | 404 |
| 19SET..... | 160 | 2601H..... | 307 | 7011..... | 415 | 18913..... | 415 |
| 106..... | 359 | 2616..... | 445 | 7012..... | 415 | 18913P..... | 404 |
| 130S0..... | 381 | 2814..... | 442 | 7013..... | 415 | 18913PHC..... | 404 |
| 131PE..... | 381 | 3016..... | 442 | 7014..... | 415 | 18913SP..... | 404 |
| 132SL..... | 381 | 3209..... | 442 | 7015..... | 415 | 18913SPHC..... | 404 |
| 240..... | 453 | 3218..... | 444 | 7016..... | 415 | 18914..... | 415 |
| 300..... | 453 | 3300..... | 149, 430 | 7017..... | 415 | 18914P..... | 404 |
| 360..... | 453 | 3306..... | 147, 428 | 7018..... | 415 | 18914PHC..... | 404 |
| 363..... | 396 | 3306T..... | 150, 428 | 9525..... | 425 | 18914SP..... | 404 |
| 420..... | 453 | 3307..... | 147, 428 | 13001..... | 393 | 18914SPHC..... | 404 |
| 450..... | 308 | 3307T..... | 150, 428 | 13005..... | 393 | 18915..... | 415 |
| 475..... | 79, 395 | 3308..... | 147, 428 | 17080..... | 442 | 18915P..... | 404 |
| 480..... | 453 | 3309..... | 147, 428 | 17135..... | 442 | 18915PHC..... | 404 |
| 510K..... | 358 | 3312..... | 149, 430 | 17160..... | 442 | 18915SP..... | 404 |
| 510P..... | 358 | 3312T..... | 150, 428 | 18040..... | 402 | 18915SPHC..... | 404 |
| 511K..... | 358 | 3316..... | 149, 430 | 18706..... | 402 | 18916..... | 415 |
| 511P..... | 358 | 3316T..... | 150, 428 | 18707..... | 402 | 18916P..... | 404 |
| 512K..... | 358 | 3317..... | 149, 430 | 18708..... | 402 | 18916PHC..... | 404 |
| 524..... | 396 | 3317T..... | 150, 428 | 18709..... | 402 | 18916SP..... | 404 |
| 524ST..... | 376 | 3318..... | 149, 430 | 18710..... | 402 | 18916SPHC..... | 404 |
| 674..... | 443 | 3318T..... | 150, 428 | 18711..... | 402 | 18917..... | 415 |
| 699..... | 396 | 3319..... | 149, 430 | 18712..... | 402 | 18917P..... | 404 |
| 699ST..... | 376 | 3319T..... | 150, 428 | 18713..... | 402 | 18917PHC..... | 404 |
| 744..... | 395 | 3512..... | 442 | 18714..... | 402 | 18917SP..... | 404 |
| 801..... | 395 | 3612..... | 444 | 18715..... | 402 | 18917SPHC..... | 404 |
| 814..... | 445 | 3614..... | 444 | 18716..... | 402 | 18918..... | 415 |
| 836..... | 445 | 3616..... | 444 | 18717..... | 402 | 18918P..... | 404 |
| 897..... | 395 | 3714..... | 442 | 18718..... | 402 | 18918PHC..... | 404 |
| 913..... | 396 | 3801..... | 394 | 18719..... | 402 | 18918SP..... | 404 |
| 913ST..... | 376 | 3806..... | 394 | 18720..... | 402 | 18918SPHC..... | 404 |
| 918..... | 395 | 3807..... | 394 | 18724..... | 402 | 18919..... | 415 |
| 918SS..... | 79 | 3808..... | 394 | 18728..... | 402 | 18919P..... | 404 |
| 989..... | 395 | 3809..... | 394 | 18731..... | 402 | 18919PHC..... | 404 |
| 998..... | 395 | 3810..... | 394 | 18744..... | 402 | 18919SP..... | 404 |
| 1004..... | 396 | 3812..... | 394 | 18907..... | 415 | 18919SPHC..... | 404 |
| 1139..... | 445 | 3813..... | 394 | 18907P..... | 404 | 18920..... | 415 |
| 1187..... | 395 | 3814..... | 394 | 18907PHC..... | 404 | 18920P..... | 404 |
| 1187SS..... | 79 | 4016..... | 442 | 18907SP..... | 404 | 18920PHC..... | 404 |
| 1188..... | 79, 395 | 4100..... | 308 | 18907SPHC..... | 404 | 18920SP..... | 404 |
| 1190..... | 79, 395 | 4150..... | 308 | 18908..... | 415 | 18920SPHC..... | 404 |
| 1200..... | 79, 395 | 4212..... | 444 | 18908P..... | 404 | 19001..... | 160 |
| 1300..... | 79, 395 | 4214..... | 444 | 18908PHC..... | 404 | 19004..... | 160 |
| 1300SS..... | 79 | 4216..... | 444 | 18908SP..... | 404 | 19006..... | 387, 436 |
| 1347..... | 391 | 4218..... | 444 | 18908SPHC..... | 404 | 19007..... | 387 |
| 1423..... | 390 | 4220..... | 444 | 18909..... | 415 | 19008..... | 386 |
| 1597..... | 453 | 4406..... | 146, 427 | 18909P..... | 404 | 19009..... | 439 |
| 1597H..... | 453 | 4406T..... | 146, 427 | 18909PHC..... | 404 | 19024..... | 440 |
| 1600..... | 395 | 4407..... | 146, 427 | 18909SP..... | 404 | 19029..... | 440 |
| 1636..... | 445 | 4407T..... | 146, 427 | 18909SPHC..... | 404 | 19030..... | 440 |
| 1698..... | 453 | 4909..... | 442 | 18910..... | 415 | 19033..... | 440 |
| 1836..... | 445 | 5212..... | 442 | 18910P..... | 404 | 19075..... | 387 |
| 1842..... | 445 | 5414..... | 442 | 18910PHC..... | 404 | 19104..... | 440 |
| 2109..... | 442 | 5616..... | 442 | 18910SP..... | 404 | 19107..... | 440 |
| 2124..... | 453 | 6109..... | 442 | 18910SPHC..... | 404 | 28710..... | 403 |
| 2130..... | 453 | 6412..... | 442 | 18911..... | 415 | 28711..... | 403 |
| 2136..... | 453 | 6614..... | 442 | 18911P..... | 404 | 28712..... | 403 |
| 2142..... | 453 | 6816..... | 442 | 18911PHC..... | 404 | 28713..... | 403 |
| 2148..... | 453 | 7006..... | 415 | 18911SP..... | 404 | 28714..... | 403 |
| 2154..... | 453 | 7007..... | 415, 422 | 18911SPHC..... | 404 | 28715..... | 403 |
| 2212..... | 445 | 7007E..... | 422 | 18912..... | 415 | 28716..... | 403 |
| 2242..... | 445 | 7008..... | 415, 422 | 18912P..... | 404 | 28717..... | 403 |
| 2414..... | 445 | 7008E..... | 422 | 18912PHC..... | 404 | 28718..... | 403 |
| 2512..... | 442 | 7009..... | 415 | 18912SP..... | 404 | 159740..... | 453 |

| | | | | | | | |
|---------------|-----|-----------------|----------|---------------|---------------|---------------|----------|
| 159760..... | 453 | A90152..... | 410 | AFAUC1..... | 169, 171, 189 | ATP16..... | 257, 446 |
| 190039..... | 432 | A90161.5..... | 410 | AFP958..... | 393 | AWB7..... | 248 |
| 1900312..... | 432 | A90162..... | 410 | AHM485..... | 390 | AWB10..... | 248 |
| A2006..... | 408 | A90671.5..... | 410 | ALLEGCU1..... | 189 | AWB12..... | 248 |
| A2007..... | 408 | A90672..... | 410 | ALLEGCU2..... | 189 | AWB147..... | 248 |
| A2008..... | 408 | AB6..... | 269 | ALMH4..... | 313 | AWB179..... | 249 |
| A2009..... | 408 | AB8..... | 269 | ALMS5..... | 313 | AWB617..... | 249 |
| A2010..... | 408 | AB10WH..... | 39 | A0080..... | 161 | AWB621..... | 249 |
| A2011..... | 408 | AB12..... | 269 | A0120..... | 161 | AWB1016..... | 249 |
| A2012..... | 408 | AB12WH..... | 39 | A0150..... | 161 | AWB1021..... | 249 |
| A2013..... | 408 | AB13..... | 269 | AOR18..... | 397 | AWB1210..... | 248 |
| A2014..... | 408 | AB14..... | 269 | AOR24..... | 397 | AWC49..... | 362 |
| A2015..... | 408 | AB16WH..... | 39 | AOR36..... | 397 | AWM10..... | 240 |
| A2016..... | 408 | AB30WH..... | 39 | AOR48..... | 397 | AWM12..... | 240 |
| A2017..... | 408 | AB131..... | 173 | API2WH..... | 39 | AWM14..... | 240 |
| A2018..... | 408 | AB189..... | 257, 285 | APC2..... | 437 | AWM17..... | 240 |
| A4004..... | 412 | AB211..... | 173 | APCU..... | 163 | AWM21..... | 240 |
| A4006..... | 412 | AB249..... | 257, 285 | AR060..... | 161 | AWM25..... | 240 |
| A4007..... | 412 | AB329..... | 257, 285 | AR080..... | 161 | AWM171..... | 240 |
| A4008..... | 412 | ABHB46..... | 81 | AR100..... | 161 | AWMB11..... | 241 |
| A4009..... | 412 | ABHB69..... | 81 | ARB3..... | 287 | AWMB12..... | 241 |
| A4010..... | 412 | ABHC46..... | 81 | ARP6WH..... | 39 | AWMB14..... | 241 |
| A4011..... | 412 | ABHC69..... | 81 | ARP7WH..... | 39 | AWMEL19..... | 216 |
| A4012..... | 412 | ABHG46..... | 81 | ARP9WH..... | 39 | AWMEL21..... | 216 |
| A4013..... | 412 | ABHG69..... | 81 | ARPI0WH..... | 39 | AWMEL23..... | 216 |
| A4014..... | 412 | ABHS46..... | 81 | AS20..... | 280 | AWMSQ53..... | 216 |
| A4015..... | 412 | ABHS69..... | 81 | ASC5..... | 384 | AWMSQ73..... | 216 |
| A4016..... | 412 | AC555..... | 296 | ASC12..... | 384 | AWMSQ94..... | 216 |
| A9005..... | 410 | AC579..... | 293 | ASC24..... | 384 | AWMSQ117..... | 216 |
| A9006..... | 410 | AC777..... | 296 | ASC38..... | 384 | AWR10..... | 295 |
| A80012..... | 394 | ACB118..... | 313 | ASC58..... | 384 | AWRRP..... | 295 |
| A80061.5..... | 413 | ACC..... | 338 | ASC84..... | 384 | AWRS..... | 295 |
| A80062..... | 413 | ACCH..... | 338 | ASEAB12..... | 272 | AWRSP..... | 295 |
| A80071.5..... | 413 | ACF125..... | 313 | ASEAB14..... | 272 | B10..... | 47 |
| A80072..... | 413 | ACH1..... | 313 | ASEAC12..... | 272 | B10G..... | 47 |
| A80081.5..... | 413 | ACM..... | 338 | ASEAC14..... | 272 | B10W..... | 47 |
| A80082..... | 413 | ACMH..... | 338 | ASEAG12..... | 272 | B11G..... | 46 |
| A80091.5..... | 413 | ACS..... | 350 | ASEAG14..... | 272 | B11W..... | 46 |
| A80092..... | 413 | ACSH..... | 350 | ASEAS12..... | 272 | B12..... | 247 |
| A80101.5..... | 413 | ACT..... | 338 | ASEAS14..... | 272 | B12G..... | 47 |
| A80102..... | 413 | ACTH..... | 338 | ASPB..... | 81, 124 | B12W..... | 47 |
| A80112..... | 413 | ADAGIORD18..... | 172 | ASPC..... | 81, 124 | B14..... | 247 |
| A80121.5..... | 413 | ADAGIORT26..... | 172 | ASPG..... | 81, 124 | B14G..... | 46 |
| A80122..... | 413 | ADEP6..... | 409 | ASPS..... | 81, 124 | B14W..... | 46 |
| A80132..... | 413 | ADEP7..... | 409 | ATCU..... | 163 | B16..... | 247 |
| A80142..... | 413 | ADEP8..... | 409 | ATHB9..... | 305, 367 | B31..... | 136 |
| A80162..... | 413 | ADEP9..... | 409 | ATHB10..... | 305, 367 | B34..... | 136 |
| A90071.5..... | 410 | ADEP10..... | 409 | ATHB14..... | 305, 367 | B102W..... | 47 |
| A90072..... | 410 | ADEP11..... | 409 | ATHB16..... | 305, 367 | B104W..... | 47 |
| A90081.5..... | 410 | ADEP12..... | 409 | ATHC9..... | 305, 367 | B112W..... | 46 |
| A90082..... | 410 | ADEP13..... | 409 | ATHC10..... | 305, 367 | B114W..... | 46 |
| A90091.5..... | 410 | ADEP14..... | 409 | ATHC14..... | 305, 367 | B122W..... | 47 |
| A90092..... | 410 | ADEP15..... | 409 | ATHC16..... | 305, 367 | B124W..... | 47 |
| A90101.5..... | 410 | ADEP16..... | 409 | ATHG9..... | 305, 367 | B144W..... | 46 |
| A90102..... | 410 | ADEP17..... | 409 | ATHG10..... | 305, 367 | BA640A..... | 398 |
| A90111.5..... | 410 | ADEP18..... | 409 | ATHG14..... | 305, 367 | BA640S..... | 398 |
| A90112..... | 410 | ADSEAB12..... | 272 | ATHG16..... | 305, 367 | BA740A..... | 398 |
| A90121.5..... | 410 | ADSEAB14..... | 272 | ATHS9..... | 305, 367 | BA740S..... | 398 |
| A90122..... | 410 | ADSEAC12..... | 272 | ATHS10..... | 305, 367 | BA840A..... | 398 |
| A90131.5..... | 410 | ADSEAC14..... | 272 | ATHS14..... | 305, 367 | BA840S..... | 398 |
| A90132..... | 410 | ADSEAG12..... | 272 | ATHS16..... | 305, 367 | BA940A..... | 398 |
| A90141.5..... | 410 | ADSEAG14..... | 272 | ATP10..... | 257, 446 | BA940S..... | 398 |
| A90142..... | 410 | ADSEAS12..... | 272 | ATP12..... | 257, 446 | BA1040A..... | 398 |
| A90151.5..... | 410 | ADSEAS14..... | 272 | ATP14..... | 257, 446 | BA1040S..... | 398 |

| | | | | | | | |
|---------------|----------|------------------|----------|-------------------|-----|------------------|----------|
| BAKNOB..... | 398 | BCR9ST..... | 332 | BLB1926..... | 450 | BPF8..... | 333 |
| BAM14..... | 246 | BCRI5ST..... | 332 | BLBAG19..... | 450 | BPG67..... | 113 |
| BAM18..... | 246 | BD35..... | 56 | BLBAG26..... | 450 | BPG101..... | 113 |
| BAM22..... | 246 | BD45..... | 56 | BLCHBC1..... | 314 | BPH21..... | 333 |
| BAM53..... | 247 | BD55..... | 56 | BLCHD1..... | 314 | BPNS115..... | 152 |
| BAM73..... | 247 | BD65..... | 56 | BLCHL1..... | 314 | BPR42CO..... | 43 |
| BAM94..... | 247 | BD72..... | 56 | BLCHL2..... | 314 | BPR84BI..... | 43 |
| BAM124..... | 247 | BD87..... | 56 | BLCHR1..... | 314 | BPR128CR..... | 43 |
| BAM141..... | 246 | BD93..... | 56 | BLCHS1..... | 314 | BPS4CO..... | 43 |
| BAM148..... | 246 | BDS2..... | 319 | BLDB1212..... | 451 | BPS8CR..... | 43 |
| BAM189..... | 246 | BDS3..... | 319 | BLDB2216..... | 451 | BPSW15..... | 333 |
| BAM211..... | 246 | BDS4..... | 319 | BLDB2412..... | 451 | BPSW20..... | 333 |
| BAM1812..... | 246 | BEE300..... | 148, 429 | BLDX1805..... | 450 | BPT3..... | 124 |
| BAMBL4..... | 317 | BEE312..... | 148, 429 | BLDX2005..... | 450 | BPW13..... | 333 |
| BAMBL125..... | 317 | BEE316..... | 148, 429 | BLH19..... | 334 | BPWC7..... | 333 |
| BAMCH4..... | 317 | BEE317..... | 148, 429 | BLHF10..... | 190 | BR15..... | 286, 287 |
| BAMCH125..... | 317 | BEE318..... | 148, 429 | BLHML..... | 190 | BR126..... | 287 |
| BAMRD2..... | 298 | BEE319..... | 148, 429 | BLHP10..... | 190 | BR128..... | 287 |
| BAMRN1..... | 298 | BEE600..... | 148, 429 | BLHSA10..... | 190 | BROWNBM1218..... | 375 |
| BAMRSET..... | 298 | BEE606..... | 148, 429 | BLHSP..... | 190 | BRR6..... | 286 |
| BAMSL52..... | 247 | BEE607..... | 148, 429 | BLHSP6..... | 190 | BRR9..... | 286 |
| BAMSL82..... | 247 | BEV820..... | 303 | BLHSP10..... | 190 | BRS2..... | 293 |
| BAMSL92..... | 247 | BEV1220..... | 303 | BLHSS..... | 190 | BRT1..... | 284 |
| BAMSL112..... | 247 | BEVB556..... | 303 | BLHSS10..... | 190 | BRT2..... | 284 |
| BAR6..... | 373 | BEVB6612..... | 303 | BLHT1..... | 190 | BRT3..... | 284 |
| BARB5..... | 128, 372 | BEVC655..... | 303 | BLHT2..... | 190 | BS18..... | 350 |
| BARB7..... | 128, 372 | BEVC1266..... | 303 | BLHT6..... | 190 | BS28..... | 350 |
| BARC5..... | 128, 372 | BEVDG6..... | 302 | BLLB81..... | 96 | BS31..... | 136 |
| BARC7..... | 128, 372 | BEVDG20..... | 302 | BLLB94..... | 96 | BS64..... | 385 |
| BARG5..... | 128, 372 | BEVDG126..... | 302 | BLM24..... | 375 | BSB12..... | 357 |
| BARG7..... | 128, 372 | BEVDG129..... | 302 | BLR14..... | 334 | BSFP8..... | 378 |
| BARS5..... | 128 | BEVG6..... | 302 | BLS14..... | 334 | BSFP10..... | 378 |
| BARS7..... | 373 | BEVG20..... | 302 | BLSB80..... | 96 | BSFP11..... | 378 |
| BAS1..... | 103 | BEVG126..... | 302 | BLSB93..... | 96 | BSFP12..... | 378 |
| BASQ620..... | 398 | BEVG129..... | 302 | BLSB1512..... | 451 | BSG12..... | 357 |
| BASQ820..... | 398 | BG159..... | 207 | BLSMA100V4CO..... | 321 | BSH20..... | 335 |
| BASQ1020..... | 398 | BG189..... | 207 | BLSMA100V4TR..... | 321 | BSKB80..... | 98 |
| BB1WH..... | 48 | BG1911..... | 207 | BLSMA100V4WH..... | 321 | BSKB96..... | 98 |
| BB2..... | 345 | BG2113..... | 207 | BLSMA510WT..... | 321 | BSKB811..... | 99 |
| BB4..... | 322 | BH31..... | 136 | BLUP5..... | 45 | BSKC08..... | 98 |
| BB5WH..... | 48 | BHCHBC1..... | 314 | BLUP6..... | 45 | BSKC69..... | 98 |
| BB8..... | 322 | BHCHD1..... | 314 | BLUP8..... | 45 | BSKC118..... | 99 |
| BB12..... | 322 | BHCHL1..... | 314 | BLUP11..... | 45 | BSPH2..... | 124 |
| BB15..... | 322 | BHCHL2..... | 314 | BLUP14..... | 45 | BSPH4..... | 124 |
| BB812..... | 259 | BHCHR1..... | 314 | BM16H..... | 337 | BSPP4..... | 56 |
| BB816..... | 259 | BHCHS1..... | 314 | BM16P..... | 337 | BSPP5..... | 56 |
| BB6105..... | 359 | BHH19..... | 334 | BM23..... | 375 | BSPP6..... | 56 |
| BBC2..... | 345 | BHM2..... | 148 | BMH221..... | 308 | BSPP8..... | 56 |
| BBC39..... | 374 | BHMPLUGS..... | 154 | BNCB84..... | 128 | BSPP9..... | 56 |
| BBLWH..... | 48 | BHR14..... | 334 | BNCC48..... | 128 | BSPP11..... | 56 |
| BBLWM..... | 48 | BHS109..... | 350 | BNRB6..... | 301 | BSPP12..... | 56 |
| BBR4CO..... | 43 | BHS117..... | 350 | BNRB20..... | 301 | BSPT5..... | 124 |
| BBR12..... | 322 | BHS124..... | 350 | BNRB46C..... | 97 | BSR14..... | 335 |
| BBR15..... | 322 | BHSP2..... | 154 | BNRB64B..... | 97 | BSS7..... | 102 |
| BBR20BI..... | 43 | BL10G..... | 47 | BNRB68C..... | 97 | BSS8..... | 102 |
| BBRB..... | 322 | BL10W..... | 47 | BNRB86B..... | 97 | BSS11..... | 102 |
| BBRC..... | 345 | BL11G..... | 46 | BNRB126..... | 301 | BSS12..... | 357 |
| BBS9CO..... | 43 | BL11W..... | 46 | BNRB129..... | 301 | BSSET..... | 350 |
| BBS44CR..... | 43 | BL12G..... | 47 | BNSB3..... | 126 | BSST12..... | 357 |
| BC1..... | 314 | BL12W..... | 47 | BNSC3..... | 126 | BT12X12..... | 375 |
| BCH4..... | 315 | BL14G..... | 46 | BP39..... | 439 | BTS2..... | 287 |
| BCH18ST..... | 332 | BL14W..... | 46 | BP51..... | 439 | BTS12..... | 365 |
| BCH125..... | 315 | BLACKBM1218..... | 375 | BPCL72..... | 333 | BTS16..... | 365 |
| BCM2..... | 124 | BLB1914..... | 450 | BPD13..... | 333 | BTTL9..... | 361 |

| | | | | | | | |
|---------------|----------|--------------|-----|---------------|----------|----------------|---------|
| B TTL11..... | 361 | CAR10..... | 405 | CBL40CL..... | 23 | CHC2..... | 120 |
| B TTL13..... | 375 | CAR10HC..... | 405 | CBL40SH..... | 23 | CHC4..... | 120 |
| BUH18..... | 335 | CAR11..... | 405 | CBL50CL..... | 23 | CHG2..... | 120 |
| BUR15..... | 335 | CAR11HC..... | 405 | CBL50SH..... | 23 | CHG4..... | 120 |
| BUS309..... | 432 | CAR12..... | 405 | CBL54ST..... | 213, 392 | CHGS..... | 316 |
| BUS312..... | 432 | CAR12HC..... | 405 | CBL78..... | 213 | CHPC..... | 316 |
| BVHF..... | 190 | CAR13..... | 405 | CBL95CL..... | 22 | CHPF..... | 316 |
| BVHF10..... | 190 | CAR13HC..... | 405 | CBL95SH..... | 22 | CHPH..... | 316 |
| BVHL..... | 190 | CAR14..... | 405 | CBL96SH..... | 213, 392 | CHPP..... | 316 |
| BVHML..... | 190 | CAR14HC..... | 405 | CBL141CL..... | 213, 392 | CHS2..... | 120 |
| BVHP10..... | 190 | CAR15..... | 405 | CBL185..... | 213 | CHS4..... | 120 |
| BVHSA10..... | 190 | CAR15HC..... | 405 | CBL325..... | 213 | CHSP2..... | 154 |
| BVHSP..... | 190 | CAR16..... | 405 | CBPI6CL..... | 22 | CIFD..... | 59 |
| BVHSP6..... | 190 | CAR16HC..... | 405 | CBPI6SH..... | 22 | CIFDR..... | 59 |
| BVHSP10..... | 190 | CAR17..... | 405 | CBR15..... | 322 | CIG85..... | 58, 183 |
| BVHSS..... | 190 | CAR17HC..... | 405 | CBRB..... | 322 | CIP03..... | 182 |
| BVHSS10..... | 190 | CAR18..... | 405 | CBRB12..... | 322 | CIP04..... | 182 |
| BVHT1..... | 190 | CAR18HC..... | 405 | CBS33..... | 365 | CIP0V63..... | 58, 183 |
| BVHT2..... | 190 | CAR19..... | 405 | CC10C..... | 383 | CIP0V856..... | 58, 183 |
| BVHT6..... | 190 | CAR19HC..... | 405 | CC10F..... | 383 | CIP0V6040..... | 58, 183 |
| BVJGB5..... | 145 | CAR20..... | 405 | CC12C..... | 383 | CIP0V9567..... | 58, 183 |
| BVJGG4..... | 145 | CAR20HC..... | 405 | CC12F..... | 383 | CIPR3..... | 182 |
| BVJM8..... | 145 | CAR21..... | 405 | CCA W7..... | 104 | CIPR4..... | 182 |
| BVTB7..... | 145 | CAR21HC..... | 405 | CCAW8..... | 104 | CIPR42..... | 58, 183 |
| BVTG6..... | 145 | CAR95..... | 405 | CCAW9..... | 104 | CIPR5125..... | 58, 183 |
| BVTM9..... | 145 | CAR95HC..... | 405 | CCPLUGS..... | 153 | CIPR5500..... | 58, 183 |
| BWB105..... | 244 | CB4..... | 322 | CD4..... | 371 | CIPR5526..... | 58, 183 |
| BWB109..... | 244 | CB8..... | 322 | CD5..... | 371 | CIPR6250..... | 58, 183 |
| BWB185..... | 244 | CB12..... | 322 | CD6..... | 371 | CIPR7251..... | 58, 183 |
| BWB189..... | 244 | CB15..... | 322 | CDB4..... | 371 | CIPRT5336..... | 58, 183 |
| BWB750..... | 103 | CB338..... | 396 | CDB5..... | 371 | CIPS61..... | 58, 183 |
| BWBL..... | 245 | CBC7CL..... | 23 | CDB6..... | 371 | CIS8..... | 182 |
| BWB0..... | 245 | CBC7SH..... | 23 | CDCV77..... | 173 | CIS10..... | 182 |
| BWBR..... | 245 | CBC7ST..... | 25 | CDFP33..... | 170 | CIS12..... | 182 |
| BWBS..... | 245 | CBC8..... | 389 | CDFP44..... | 170 | CIS14..... | 182 |
| BWC9..... | 109 | CBC9..... | 389 | CDFP55..... | 173 | CIS41..... | 58, 183 |
| BWC12..... | 109 | CBC10..... | 389 | CDFP88..... | 168, 172 | CIS51..... | 58, 183 |
| BWF3..... | 244, 343 | CBC10CL..... | 23 | CDWP18..... | 172 | CIS61..... | 58, 183 |
| BWF4..... | 244, 343 | CBC10SH..... | 23 | CDWP26..... | 172 | CKNF1..... | 197 |
| BWP84..... | 114 | CBC10ST..... | 25 | CDWP66..... | 173 | CKNF2..... | 197 |
| BWPG84..... | 114 | CBC12..... | 389 | CDWPM19..... | 170 | CKNF3..... | 197 |
| BWPH84..... | 114 | CBF8..... | 389 | CDWPM27..... | 170 | CKNF4..... | 197 |
| BWPHG84..... | 114 | CBF9..... | 389 | CER5..... | 200 | CKNF5..... | 197 |
| BWR34..... | 161 | CBF10..... | 389 | CER7..... | 200 | CKNF6..... | 197 |
| BZZ59C..... | 95 | CBF12..... | 389 | CER9..... | 200 | CKNF7..... | 197 |
| BZZ95B..... | 95 | CBL4CL..... | 23 | CER15..... | 199 | CKNF8..... | 197 |
| CADDYSS..... | 151 | CBL4SH..... | 23 | CER19..... | 199 | CKOW1..... | 197 |
| CADDYSS2..... | 119 | CBL8CL..... | 22 | CER21..... | 199 | CKOW2..... | 197 |
| CADDYW..... | 151 | CBL8SH..... | 22 | CER23..... | 199 | CKOW3..... | 197 |
| CADDYW2..... | 119 | CBL12CL..... | 23 | CER25..... | 199 | CKOW4..... | 197 |
| CAP2..... | 146, 427 | CBL12SH..... | 23 | CERAM12..... | 419 | CKOW7..... | 197 |
| CAP3..... | 67 | CBL12ST..... | 25 | CERAM14..... | 419 | CKOW8..... | 197 |
| CAP6..... | 67 | CBL13CL..... | 22 | CERAM16..... | 419 | CLIPIT2..... | 313 |
| CAP8..... | 67 | CBL13SH..... | 22 | CERAM18..... | 419 | CLIPIT6..... | 313 |
| CAP16..... | 67 | CBL16CL..... | 23 | CF1..... | 173 | CM4..... | 144 |
| CAP25..... | 146, 427 | CBL16SH..... | 23 | CFKIT..... | 173 | CM12CL..... | 23 |
| CAR6..... | 405 | CBL16ST..... | 25 | CFP4..... | 132 | CM12SH..... | 23 |
| CAR6HC..... | 405 | CBL20CL..... | 22 | CH4..... | 308 | CM12ST..... | 25 |
| CAR7..... | 405 | CBL20SH..... | 22 | CH6..... | 308 | CM16H..... | 337 |
| CAR7HC..... | 405 | CBL20ST..... | 25 | CH8..... | 308 | CM16P..... | 337 |
| CAR8..... | 405 | CBL24CL..... | 23 | CH10..... | 308 | CM96H..... | 336 |
| CAR8HC..... | 405 | CBL24SH..... | 23 | CHB32..... | 365 | CM192H..... | 336 |
| CAR9..... | 405 | CBL32CL..... | 23 | CHBS..... | 316 | CMCC5..... | 118 |
| CAR9HC..... | 405 | CBL32SH..... | 23 | CHBST112..... | 374 | CMCSW2..... | 318 |

| | | | | | | | |
|---------------|----------|---------------|----------|----------------|----------|---------------|----------|
| CMP425..... | 318 | CSJCUP..... | 351 | DPN9DN..... | 35 | DWPS64..... | 115 |
| CMP520..... | 318 | CSM2..... | 105, 431 | DPN9LN..... | 35 | DWRB2..... | 177, 279 |
| CMP553..... | 318 | CSM3..... | 105, 431 | DPN9WH..... | 32 | DWRB5..... | 177, 279 |
| CMSP..... | 153 | CSM40..... | 105, 431 | DPNIODN..... | 35 | DWS2..... | 138 |
| COLD8..... | 177 | CSP2..... | 154 | DPNIOLN..... | 35 | DWS5..... | 117 |
| CP6CL..... | 22 | CSP4..... | 203 | DPNIOWH..... | 32 | DWSC7..... | 135 |
| CP6SH..... | 22 | CSPR1..... | 153 | DPR1..... | 348 | DWSEA10..... | 270 |
| CP6ST..... | 25 | CSPS3..... | 153 | DPS797..... | 435 | DWSEA12..... | 270 |
| CP7CL..... | 22 | CSPT2..... | 153 | DPW6WH..... | 32 | DWSEA14..... | 270 |
| CP7SH..... | 22 | CSR26..... | 168 | DPW7WH..... | 32 | DWSEA16..... | 270 |
| CP7ST..... | 25 | CT2..... | 146, 427 | DPW9WH..... | 32 | DWSEA18..... | 270 |
| CP9CL..... | 22 | CTP6..... | 407 | DPWIOWH..... | 32 | DWSS5..... | 138 |
| CP9SH..... | 22 | CTP7..... | 407 | DRB18230..... | 422 | DWWC5..... | 361 |
| CP9ST..... | 25 | CTP8..... | 407 | DRBC1826..... | 422 | DWWP50..... | 117 |
| CP10CL..... | 22 | CTP9..... | 407 | DRP774..... | 422 | DXCH1..... | 315 |
| CP10SH..... | 22 | CTP10..... | 407 | DRP884..... | 422 | DXP4..... | 155 |
| CP10ST..... | 25 | CTP11..... | 407 | DRPE800..... | 422 | EBB59B..... | 95 |
| CP12CL..... | 22 | CTP12..... | 407 | DRPE878..... | 422 | EBB95C..... | 95 |
| CP12SH..... | 22 | CTP13..... | 407 | DRPS5725..... | 422 | EBSS312..... | 374 |
| CP12ST..... | 25 | CTP14..... | 407 | DRPS5825..... | 422 | ELEBLA..... | 320 |
| CP150..... | 145 | CTP15..... | 407 | DS5WH..... | 32 | ELEBME..... | 320 |
| CP300..... | 145 | CTP16..... | 407 | DS6704..... | 385, 423 | ELEBSM..... | 320 |
| CP500..... | 145 | CTP17..... | 407 | DS6706..... | 385, 423 | EM199..... | 308, 426 |
| CPL12CL..... | 22 | CTP18..... | 407 | DSCIWH..... | 33, 141 | EM200..... | 308, 426 |
| CPL12SH..... | 22 | CTP19..... | 407 | DSC3WH..... | 33, 141 | EM400..... | 308, 426 |
| CPL14..... | 213 | CTS31..... | 162 | DSP11..... | 417 | EM1200..... | 308, 426 |
| CPL21..... | 213 | CWP7..... | 390 | DSP15..... | 417 | ER333..... | 391 |
| CPM62..... | 152 | CWP8..... | 390 | DSP18..... | 417 | ER387..... | 391 |
| CRGSQ53..... | 208 | CWP12..... | 390 | DSP6705..... | 385, 423 | ER444..... | 391 |
| CRGSQ73..... | 208 | D404..... | 136 | DT2..... | 146, 427 | ER487..... | 391 |
| CRGSQ94..... | 208 | D405..... | 136 | DT3..... | 169, 189 | ER587..... | 391 |
| CRGSQ117..... | 208 | D406..... | 136 | DT4..... | 169, 189 | ES474..... | 391 |
| CRGT19..... | 208 | DB5WH..... | 33 | DT6..... | 146, 427 | EWB6..... | 78 |
| CRGT21..... | 208 | DB7WH..... | 33 | DWB6..... | 269 | EWB8..... | 78 |
| CRGT23..... | 208 | DB8WH..... | 33 | DWB10..... | 269 | EWB10..... | 78 |
| CRH3..... | 288 | DB10DN..... | 35 | DWB12..... | 269 | EWM6..... | 78 |
| CRL86..... | 106 | DB10LN..... | 35 | DWB14..... | 269 | EWM16..... | 78 |
| CRM922..... | 380 | DB10WH..... | 33 | DWB16..... | 269 | FBC92..... | 86 |
| CRMK2..... | 134 | DB12WH..... | 33 | DWBH4..... | 268, 362 | FBS591..... | 86 |
| CRMK4..... | 134 | DBN16DN..... | 35 | DWBH6..... | 268 | FBSR43..... | 89 |
| CRMK6..... | 134 | DBN16LN..... | 35 | DWBH10..... | 268 | FBSS44..... | 89 |
| CRS1..... | 293 | DBN16WH..... | 33 | DWBH12..... | 268 | FCD1..... | 86 |
| CRS3..... | 288 | DBN24WH..... | 33 | DWBH14..... | 268 | FCD2..... | 86 |
| CRS68..... | 106 | DBN32WH..... | 33 | DWBH16..... | 268 | FCH35..... | 69 |
| CS8..... | 359 | DBP1826..... | 422 | DWBT15..... | 369 | FCH325..... | 69 |
| CS31..... | 365 | DBW16WH..... | 33 | DWBT185..... | 369 | FCS16..... | 371 |
| CS080..... | 351 | DD5274..... | 424 | DWC5..... | 117 | FFB59..... | 86 |
| CS100..... | 351 | DD5275..... | 425 | DWC7..... | 339 | FFC335..... | 69 |
| CS125..... | 161 | DD5701..... | 424 | DWCH7..... | 339 | FFC337..... | 68 |
| CS200..... | 351 | DD5703..... | 425 | DWCP16..... | 117 | FFCCH37..... | 71 |
| CS301..... | 360 | DD5704..... | 425 | DWCP48..... | 116 | FFCCH45..... | 71 |
| CS7545..... | 360 | DD5705..... | 424 | DWCP50..... | 117 | FFCCS45..... | 71 |
| CSC4CL..... | 23, 141 | DDCH7744..... | 424 | DWHSEA10..... | 270 | FFCCS337..... | 71 |
| CSC4SH..... | 23, 141 | DDCH7755..... | 424 | DWHSEA12..... | 270 | FFCG45..... | 70 |
| CSC4ST..... | 25, 141 | DDW5703..... | 425 | DWHSEA14..... | 270 | FFCG337..... | 70 |
| CSC15..... | 134, 201 | DDW5705..... | 424 | DWHSEA16..... | 270 | FFCGH37..... | 70 |
| CSC20..... | 134, 201 | DGSP35..... | 125 | DWHSEA18..... | 270 | FFCGH45..... | 70 |
| CSFP8..... | 378 | DM10WH..... | 32 | DWHVSEA14..... | 276 | FFCM2..... | 68 |
| CSFP10..... | 378 | DPL9WH..... | 32 | DWHVSEA18..... | 276 | FFCP4..... | 74 |
| CSFP11..... | 378 | DPL12DN..... | 35 | DWIB40..... | 370 | FFCP6..... | 74 |
| CSFP12..... | 378 | DPL12LN..... | 35 | DWP44..... | 115 | FFCS45..... | 68 |
| CSJ108..... | 351 | DPL12WH..... | 32 | DWP64..... | 115 | FFHANDLE..... | 384 |
| CSJ116..... | 351 | DPN6WH..... | 32 | DWPH64..... | 114 | FFHM2..... | 68 |
| CSJ174..... | 351 | DPN7WH..... | 32 | DWPS44..... | 115 | FFHM35..... | 69 |

| | | | | | | | |
|----------------|-----|---------------|----------|----------------|----------|---------------|----------|
| FFHM37..... | 68 | GB16..... | 144 | GGSW6..... | 227 | GSOVL..... | 179 |
| FFHM45..... | 68 | GB300..... | 144 | GGW74..... | 227 | GSP35..... | 125 |
| FFSD3..... | 384 | GB500..... | 144 | GGW76..... | 227 | GSPC..... | 151 |
| FFSR1..... | 384 | GB1000..... | 144 | GGW96..... | 227 | GSPH2..... | 124 |
| FGRS7..... | 180 | GB1600..... | 144 | GHSP2..... | 154 | GSPH4..... | 124 |
| FGRS10..... | 180 | GBB15..... | 207 | GHW4..... | 362 | GSPR..... | 151 |
| FH1..... | 173 | GBB20..... | 207 | GJ6..... | 65 | GSPS..... | 151 |
| FLRB8..... | 212 | GBE2..... | 346 | GJ8..... | 65, 342 | GSPSR..... | 151 |
| FLRB11..... | 212 | GBE3..... | 346 | GJ24..... | 65 | GSPT5..... | 124 |
| FLRB95..... | 212 | GBE8..... | 346 | GJ40..... | 65, 286 | GSREC..... | 179 |
| FRUB9..... | 97 | GBE17..... | 346 | GLA300..... | 149, 430 | GSS6..... | 146, 427 |
| FRUB12..... | 102 | GBE34..... | 346 | GLA312..... | 149, 430 | GSSI7..... | 181 |
| FRUB18..... | 97 | GBE64..... | 346 | GLA316..... | 149, 430 | GSSS20..... | 178-180 |
| FRUC7..... | 97 | GBG14..... | 207 | GLA317..... | 149, 430 | GSSS1526..... | 180 |
| FRUC10..... | 102 | GBG19..... | 207 | GLA318..... | 149, 430 | GSST17..... | 180 |
| FRUC16..... | 97 | GBS18..... | 350 | GLA319..... | 149, 430 | GSST2514..... | 178, 180 |
| FRYB433..... | 88 | GBS28..... | 350 | GLA600..... | 146, 427 | GTP10..... | 78, 418 |
| FRYB443..... | 88 | GBSSET..... | 350 | GLACT2..... | 146, 427 | GTP12..... | 78, 418 |
| FRYR375..... | 88 | GC4..... | 119 | GLADT2..... | 146, 427 | GTP14..... | 78, 418 |
| FRYS443..... | 88 | GC8..... | 110, 347 | GLADT6..... | 146, 427 | GTP16..... | 78, 418 |
| FRYT433..... | 88 | GC12..... | 110, 347 | GLAST2..... | 146, 427 | GTP18..... | 78, 418 |
| FS9..... | 417 | GC34..... | 110, 347 | GLBASE..... | 146, 427 | GVHF..... | 191 |
| FS911..... | 388 | GC36..... | 110, 347 | GMI3..... | 236 | GVHF10..... | 191 |
| FSLT08..... | 231 | GCD28..... | 110, 347 | GM16H..... | 337 | GVHL..... | 191 |
| FSLT10..... | 231 | GCH28..... | 110, 347 | GM16P..... | 337 | GVHML..... | 191 |
| FSLT14..... | 231 | GCHB2..... | 311 | GM95..... | 236 | GVHP10..... | 191 |
| FSLT18..... | 231 | GCHB3..... | 311 | GM147..... | 236 | GVHSA10..... | 191 |
| FSLT21..... | 231 | GCHB4..... | 311 | GM189..... | 236 | GVHSP..... | 191 |
| FSLW08..... | 230 | GCHG2..... | 311 | GM210..... | 236 | GVHSP6..... | 191 |
| FSLW10..... | 230 | GCHG3..... | 311 | GM1614..... | 236 | GVHSP10..... | 191 |
| FSLW14..... | 230 | GCHG4..... | 311 | GM2113..... | 236 | GVHSS..... | 191 |
| FSLW18..... | 230 | GCHS2..... | 311 | GMB3..... | 67 | GVHSS10..... | 191 |
| FSLW21..... | 230 | GCHS3..... | 311 | GMB6..... | 67 | GVHT1..... | 191 |
| FSMEL12..... | 232 | GCHS4..... | 311 | GMB8..... | 67, 342 | GVHT2..... | 191 |
| FSMEL19..... | 232 | GCM2..... | 124 | GMB16..... | 67, 342 | GVHT6..... | 191 |
| FSMEL21..... | 232 | GCRB2613..... | 91 | GMB32..... | 67 | GW4..... | 362 |
| FSMEL23..... | 232 | GCRC1362..... | 91 | GOLDAGR18..... | 172 | GZB22..... | 67 |
| FSMEL53..... | 231 | GCS37..... | 396 | GOLDAGR26..... | 172 | HA2006..... | 408 |
| FSMEL73..... | 231 | GCSS6132..... | 91 | GOVB69..... | 94 | HA2007..... | 408 |
| FSMEL94..... | 231 | GDWC7..... | 363 | GOVB811..... | 94 | HA2008..... | 408 |
| FSMEL117..... | 231 | GDWW5..... | 363 | GOVS69..... | 94 | HA2009..... | 408 |
| FSR9..... | 232 | GF2..... | 346 | GOVS811..... | 94 | HA2010..... | 408 |
| FSR11..... | 232 | GF3..... | 346 | GP2..... | 74 | HA2011..... | 408 |
| FSR14..... | 232 | GF8..... | 346 | GP3..... | 74 | HA2012..... | 408 |
| FSWMEL53..... | 230 | GF17..... | 346 | GP4..... | 74 | HA2013..... | 408 |
| FSWMEL73..... | 230 | GF34..... | 346 | GP21..... | 179 | HA2014..... | 408 |
| FSWMEL94..... | 230 | GF68..... | 346 | GPT3..... | 124 | HA2015..... | 408 |
| FSWMEL117..... | 230 | GFC45..... | 74 | GPTUB20..... | 80, 369 | HA2016..... | 408 |
| FT15..... | 135 | GFC335..... | 74 | GR2..... | 151 | HA2017..... | 408 |
| FT25..... | 135 | GFC337..... | 74 | GRI435..... | 376 | HA2018..... | 408 |
| FT40..... | 135 | GGB74..... | 227 | GS4..... | 119 | HA4006..... | 412 |
| FWB4..... | 86 | GGB76..... | 227 | GS16..... | 181 | HA4007..... | 412 |
| FWC68..... | 107 | GGB96..... | 227 | GS18..... | 181 | HA4008..... | 412 |
| FWC69..... | 107 | GGRB3..... | 226 | GS27..... | 181 | HA4009..... | 412 |
| FWC89..... | 107 | GGRB5..... | 226 | GS81..... | 181 | HA4010..... | 412 |
| G17..... | 178 | GGRB6..... | 226 | GS1775..... | 181 | HA4011..... | 412 |
| G21..... | 179 | GGRB8..... | 226 | GSB2..... | 110, 347 | HA4012..... | 412 |
| G23..... | 179 | GGRW3..... | 226 | GSC2..... | 110, 347 | HA4013..... | 412 |
| G30..... | 178 | GGRW5..... | 226 | GSC6..... | 146, 427 | HA4014..... | 412 |
| G61..... | 181 | GGRW6..... | 226 | GSC16..... | 175 | HA4015..... | 412 |
| G72..... | 181 | GGRW8..... | 226 | GSC17..... | 175 | HA4016..... | 412 |
| G9595..... | 425 | GGSB5..... | 227 | GSC26..... | 175 | HA4017..... | 412 |
| GB3..... | 144 | GGSB6..... | 227 | GSD6..... | 146, 427 | HA4018..... | 412 |
| GB8..... | 144 | GGSW5..... | 227 | GSF2..... | 110, 347 | HA4019..... | 412 |

| | | | | | | | |
|----------------|-----|----------------|-----|-------------|---------|----------------|-----|
| HA4020..... | 412 | HA90162..... | 411 | HATP17..... | 406 | HC5116..... | 414 |
| HA5006..... | 414 | HA90171.5..... | 411 | HATP18..... | 406 | HC9005..... | 411 |
| HA5007..... | 414 | HA90172..... | 411 | HATP19..... | 406 | HC9006..... | 411 |
| HA5008..... | 414 | HA90181.5..... | 411 | HATP20..... | 406 | HC28710..... | 403 |
| HA5009..... | 414 | HA90182..... | 411 | HATP21..... | 406 | HC28711..... | 403 |
| HA5010..... | 414 | HA90671.5..... | 411 | HATP22..... | 406 | HC28712..... | 403 |
| HA5011..... | 414 | HA90672..... | 411 | HATP23..... | 406 | HC28713..... | 403 |
| HA5012..... | 414 | HACTP6..... | 407 | HATP24..... | 406 | HC28714..... | 403 |
| HA5013..... | 414 | HACTP7..... | 407 | HATP26..... | 406 | HC28715..... | 403 |
| HA5014..... | 414 | HACTP8..... | 407 | HATP28..... | 406 | HC28716..... | 403 |
| HA5015..... | 414 | HACTP9..... | 407 | HB5..... | 82, 261 | HC28717..... | 403 |
| HA5016..... | 414 | HACTP10..... | 407 | HB6..... | 82, 261 | HC28718..... | 403 |
| HA5017..... | 414 | HACTP11..... | 407 | HB7..... | 82, 261 | HC80061.5..... | 413 |
| HA5018..... | 414 | HACTP12..... | 407 | HC2006..... | 408 | HC80062..... | 413 |
| HA5106..... | 414 | HACTP13..... | 407 | HC2007..... | 408 | HC80071.5..... | 413 |
| HA5107..... | 414 | HACTP14..... | 407 | HC2008..... | 408 | HC80072..... | 413 |
| HA5108..... | 414 | HACTP15..... | 407 | HC2009..... | 408 | HC80081.5..... | 413 |
| HA5109..... | 414 | HACTP16..... | 407 | HC2010..... | 408 | HC80082..... | 413 |
| HA5110..... | 414 | HACTP17..... | 407 | HC2011..... | 408 | HC80091.5..... | 413 |
| HA5111..... | 414 | HACTP18..... | 407 | HC2012..... | 408 | HC80092..... | 413 |
| HA5112..... | 414 | HACTP19..... | 407 | HC2013..... | 408 | HC80101.5..... | 413 |
| HA5113..... | 414 | HACTP20..... | 407 | HC2014..... | 408 | HC80102..... | 413 |
| HA5114..... | 414 | HACTP21..... | 407 | HC2015..... | 408 | HC80112..... | 413 |
| HA5115..... | 414 | HACTP22..... | 407 | HC2016..... | 408 | HC80121.5..... | 413 |
| HA5116..... | 414 | HACTP23..... | 407 | HC2017..... | 408 | HC80122..... | 413 |
| HA9005..... | 411 | HACTP24..... | 407 | HC2018..... | 408 | HC80132..... | 413 |
| HA9006..... | 411 | HACTP26..... | 407 | HC4006..... | 412 | HC80142..... | 413 |
| HA80012..... | 394 | HACTP28..... | 407 | HC4007..... | 412 | HC80162..... | 413 |
| HA80061.5..... | 413 | HADEP6..... | 409 | HC4008..... | 412 | HC80182..... | 413 |
| HA80062..... | 413 | HADEP7..... | 409 | HC4009..... | 412 | HC90071.5..... | 411 |
| HA80071.5..... | 413 | HADEP8..... | 409 | HC4010..... | 412 | HC90072..... | 411 |
| HA80072..... | 413 | HADEP9..... | 409 | HC4011..... | 412 | HC90081.5..... | 411 |
| HA80081.5..... | 413 | HADEP10..... | 409 | HC4012..... | 412 | HC90082..... | 411 |
| HA80082..... | 413 | HADEP11..... | 409 | HC4013..... | 412 | HC90091.5..... | 411 |
| HA80091.5..... | 413 | HADEP12..... | 409 | HC4014..... | 412 | HC90092..... | 411 |
| HA80092..... | 413 | HADEP13..... | 409 | HC4015..... | 412 | HC90101.5..... | 411 |
| HA80101.5..... | 413 | HADEP14..... | 409 | HC4016..... | 412 | HC90102..... | 411 |
| HA80102..... | 413 | HADEP15..... | 409 | HC4017..... | 412 | HC90111.5..... | 411 |
| HA80112..... | 413 | HADEP16..... | 409 | HC4018..... | 412 | HC90112..... | 411 |
| HA80121.5..... | 413 | HADEP17..... | 409 | HC4019..... | 412 | HC90121.5..... | 411 |
| HA80122..... | 413 | HADEP18..... | 409 | HC4020..... | 412 | HC90122..... | 411 |
| HA80132..... | 413 | HADEP19..... | 409 | HC5006..... | 414 | HC90131.5..... | 411 |
| HA80142..... | 413 | HAMSC..... | 137 | HC5007..... | 414 | HC90132..... | 411 |
| HA80162..... | 413 | HAMSC3..... | 137 | HC5008..... | 414 | HC90141.5..... | 411 |
| HA80182..... | 413 | HAMSC4..... | 137 | HC5009..... | 414 | HC90142..... | 411 |
| HA90071.5..... | 411 | HAMSC15..... | 137 | HC5010..... | 414 | HC90151.5..... | 411 |
| HA90072..... | 411 | HAMSC25..... | 137 | HC5011..... | 414 | HC90152..... | 411 |
| HA90081.5..... | 411 | HAMSCB..... | 137 | HC5012..... | 414 | HC90161.5..... | 411 |
| HA90082..... | 411 | HAMSCB3..... | 137 | HC5013..... | 414 | HC90162..... | 411 |
| HA90091.5..... | 411 | HAMSCB4..... | 137 | HC5014..... | 414 | HC90171.5..... | 411 |
| HA90092..... | 411 | HAMSCG..... | 137 | HC5015..... | 414 | HC90172..... | 411 |
| HA90101.5..... | 411 | HAMSCG3..... | 137 | HC5016..... | 414 | HC90181.5..... | 411 |
| HA90102..... | 411 | HAMSCG4..... | 137 | HC5017..... | 414 | HC90182..... | 411 |
| HA90111.5..... | 411 | HATP6..... | 406 | HC5018..... | 414 | HC90671.5..... | 411 |
| HA90112..... | 411 | HATP7..... | 406 | HC5106..... | 414 | HC90672..... | 411 |
| HA90121.5..... | 411 | HATP8..... | 406 | HC5107..... | 414 | HCAD10..... | 403 |
| HA90122..... | 411 | HATP9..... | 406 | HC5108..... | 414 | HCAD12..... | 403 |
| HA90131.5..... | 411 | HATP10..... | 406 | HC5109..... | 414 | HCAD14..... | 403 |
| HA90132..... | 411 | HATP11..... | 406 | HC5110..... | 414 | HCAD16..... | 403 |
| HA90141.5..... | 411 | HATP12..... | 406 | HC5111..... | 414 | HCAD18..... | 403 |
| HA90142..... | 411 | HATP13..... | 406 | HC5112..... | 414 | HCCTP6..... | 407 |
| HA90151.5..... | 411 | HATP14..... | 406 | HC5113..... | 414 | HCCTP7..... | 407 |
| HA90152..... | 411 | HATP15..... | 406 | HC5114..... | 414 | HCCTP8..... | 407 |
| HA90161.5..... | 411 | HATP16..... | 406 | HC5115..... | 414 | HCCTP9..... | 407 |

| | | | | | | | |
|---------------|-----|-----------------|-----|----------------|-----|--------------|----------|
| HCCTP10..... | 407 | HCSS2416..... | 417 | HMMS14..... | 193 | HPBL6..... | 310 |
| HCCTP11..... | 407 | HCTF122410..... | 416 | HMMS18..... | 193 | HPBL8..... | 310 |
| HCCTP12..... | 407 | HCTF122415..... | 416 | HMOST1115..... | 264 | HPBL12..... | 310 |
| HCCTP13..... | 407 | HCTF122420..... | 416 | HMOST1317..... | 264 | HPBL18..... | 310 |
| HCCTP14..... | 407 | HCTP6..... | 406 | HMOST1520..... | 264 | HPCH4..... | 310 |
| HCCTP15..... | 407 | HCTP7..... | 406 | HMOV1418..... | 264 | HPCH6..... | 310 |
| HCCTP16..... | 407 | HCTP8..... | 406 | HMOV1621..... | 264 | HPCH8..... | 310 |
| HCCTP17..... | 407 | HCTP9..... | 406 | HMPB12..... | 369 | HPCH12..... | 310 |
| HCCTP18..... | 407 | HCTP10..... | 406 | HMPB20..... | 369 | HPCH18..... | 310 |
| HCCTP19..... | 407 | HCTP11..... | 406 | HMPLUGS..... | 154 | HPG4..... | 310 |
| HCCTP20..... | 407 | HCTP12..... | 406 | HMPRR3..... | 294 | HPG6..... | 310 |
| HCDEP6..... | 409 | HCTP13..... | 406 | HMPRS3..... | 294 | HPG8..... | 310 |
| HCDEP7..... | 409 | HCTP14..... | 406 | HMRD08..... | 264 | HPG12..... | 310 |
| HCDEP8..... | 409 | HCTP15..... | 406 | HMRD12..... | 264 | HPG18..... | 310 |
| HCDEP9..... | 409 | HCTP16..... | 406 | HMRD16..... | 264 | HPP7..... | 426 |
| HCDEP10..... | 409 | HCTP17..... | 406 | HMRRSET..... | 294 | HPP16..... | 426 |
| HCDEP11..... | 409 | HCTP18..... | 406 | HMRST1301..... | 266 | HS2..... | 139 |
| HCDEP12..... | 409 | HCTP19..... | 406 | HMRST1401..... | 266 | HS3..... | 139 |
| HCDEP13..... | 409 | HCTP20..... | 406 | HMRST1601..... | 266 | HS4..... | 139 |
| HCDEP14..... | 409 | HDD94..... | 425 | HMRST1801..... | 266 | HS8..... | 139 |
| HCDEP15..... | 409 | HDS95..... | 425 | HMRST2001..... | 266 | HSC2..... | 139 |
| HCDEP16..... | 409 | HDUT975..... | 388 | HMRST2201..... | 266 | HSC3..... | 139 |
| HCDEP17..... | 409 | HDUT1200..... | 388 | HMRT247..... | 266 | HSC4..... | 139 |
| HCDEP18..... | 409 | HDUT1600..... | 388 | HMRT712..... | 265 | HSC8..... | 139 |
| HCDS108..... | 417 | HDWS2..... | 138 | HMRT814..... | 265 | HTSH1..... | 51 |
| HCDS1410..... | 417 | HDWS5..... | 138 | HMRT1019..... | 265 | HTSH3..... | 51 |
| HCDS1712..... | 417 | HGWC1..... | 362 | HMRT1322..... | 265 | HTSH5..... | 51 |
| HCHBC1..... | 314 | HM1LAD..... | 193 | HMRT1611..... | 266 | HV3..... | 340, 342 |
| HCHD1..... | 314 | HM6TNG..... | 193 | HMSP2..... | 154 | I9540..... | 425 |
| HCHL1..... | 314 | HM8TNG..... | 193 | HMSPI813..... | 263 | IBT65..... | 299-303 |
| HCHL2..... | 314 | HM9SPN..... | 193 | HMSPI2618..... | 263 | IBT125..... | 301, 302 |
| HCHR1..... | 314 | HM10SL..... | 193 | HMSPH2..... | 123 | IBT126..... | 299-303 |
| HCHS1..... | 314 | HM10SPO..... | 193 | HMSPH4..... | 123 | IBT200..... | 299-303 |
| HCLP12..... | 417 | HM11CMF..... | 193 | HMSPT3..... | 123 | IS13..... | 281 |
| HCLP16..... | 417 | HM11FK..... | 193 | HMSPT5..... | 123 | IS18..... | 282 |
| HCLP24..... | 417 | HM12NOT..... | 193 | HMSQ12..... | 265 | IS734..... | 358 |
| HCR86..... | 403 | HM12PAS..... | 193 | HMSQ14..... | 265 | IS900..... | 358 |
| HCR137..... | 403 | HM12SL..... | 193 | HMSQ16..... | 265 | ISPI8..... | 282 |
| HCR148..... | 403 | HM12SOL..... | 193 | HMSQ18..... | 265 | ISSB4..... | 370 |
| HCR168..... | 403 | HM14KN..... | 193 | HMSQ20..... | 265 | ISSB6..... | 370 |
| HCSQ610..... | 416 | HMBAR8..... | 373 | HMSQ22..... | 265 | ISW2..... | 390 |
| HCSQ615..... | 416 | HMBAR9..... | 128 | HMSR6..... | 368 | ISW3..... | 390 |
| HCSQ620..... | 416 | HMBV1..... | 123 | HMSR7..... | 368 | IT400..... | 127 |
| HCSQ810..... | 416 | HMCB14..... | 340 | HMSR8..... | 368 | IT700..... | 127 |
| HCSQ815..... | 416 | HMCC14..... | 340 | HMSRSPH2..... | 123 | IT878..... | 388 |
| HCSQ820..... | 416 | HMCD4..... | 371 | HMSRSPH3..... | 123 | ITPI213..... | 441 |
| HCSQ1010..... | 416 | HMCD5..... | 371 | HMSSQPH2..... | 123 | ITPI222..... | 441 |
| HCSQ1015..... | 416 | HMCD6..... | 371 | HMST10..... | 263 | ITPI238..... | 441 |
| HCSQ1020..... | 416 | HMCM2..... | 123 | HMST12..... | 263 | ITPI246..... | 441 |
| HCSQ1210..... | 416 | HMCS14..... | 340 | HMST20..... | 263 | ITPI413..... | 441 |
| HCSQ1215..... | 416 | HMD0B19149..... | 369 | HMTB14..... | 341 | ITPI422..... | 441 |
| HCSQ1220..... | 416 | HMDWB14..... | 268 | HMTB16..... | 341 | ITPI438..... | 441 |
| HCSQ1410..... | 416 | HMDWB19..... | 268 | HMTC14..... | 341 | ITPI446..... | 441 |
| HCSQ1415..... | 416 | HMJ4..... | 66 | HMTC16..... | 341 | ITPI713..... | 441 |
| HCSQ1420..... | 416 | HMJ5..... | 66 | HMTS14..... | 341 | ITPI722..... | 441 |
| HCSQ1610..... | 416 | HMJ6..... | 66 | HMTS16..... | 341 | ITPI738..... | 441 |
| HCSQ1615..... | 416 | HMMJ1..... | 66 | HMWB..... | 364 | ITPI746..... | 441 |
| HCSQ1620..... | 416 | HMMJ2..... | 66 | HMWBSTND..... | 364 | ITPI913..... | 441 |
| HCSS12..... | 417 | HMMJ3..... | 66 | HMWC75..... | 363 | ITPI922..... | 441 |
| HCSS14..... | 417 | HMMJ4..... | 66 | HMWP44..... | 115 | ITPI938..... | 441 |
| HCSS16..... | 417 | HMMJ5..... | 66 | HMWP64..... | 115 | ITPI946..... | 441 |
| HCSS248..... | 417 | HMMS10..... | 193 | HMWP85..... | 115 | ITS6..... | 194 |
| HCSS1411..... | 417 | HMMS12..... | 193 | HMWP97..... | 115 | J201..... | 352 |
| HCSS1812..... | 417 | HMMS13..... | 193 | HPBL4..... | 310 | J202..... | 352 |

| | | | | | | | |
|----------------|----------|---------------|----------|----------------|----------|-----------------|----------|
| J202A..... | 352 | JUICE1..... | 188 | LFTBW11..... | 222 | MB1..... | 136 |
| J203..... | 352 | JUICE2..... | 188 | LFTBW12..... | 224 | MB3..... | 136 |
| J204..... | 352 | JUICE3..... | 185 | LFTBW16..... | 224 | MB4..... | 136 |
| J205..... | 352 | JUICE4..... | 185 | LFTD3..... | 251 | MB14..... | 235 |
| J206..... | 352 | JUICE5..... | 187 | LFTD4..... | 251 | MB17..... | 235 |
| J208..... | 352 | JUICE6..... | 186 | LFTD8..... | 223, 251 | MB21..... | 235 |
| J212..... | 352 | JUICE12..... | 186, 187 | LFTD11..... | 223, 251 | MB25..... | 235 |
| J214..... | 352 | KBB5..... | 85 | LFTD12..... | 223, 251 | MB93..... | 60 |
| J222..... | 352 | KBB7..... | 85 | LFTD135..... | 251 | MB171..... | 235 |
| J263..... | 352 | KBB9..... | 85 | LFTPBI1..... | 223 | MBM2..... | 258, 448 |
| J266..... | 352 | KBC6..... | 174 | LFTPBI2..... | 223 | MBM3..... | 258, 448 |
| JBASE1..... | 185 | KBC10..... | 174 | LFTPBI3..... | 223 | MBM4..... | 258, 448 |
| JBASE2..... | 185 | KBC12..... | 174 | LFTPWI1..... | 223 | MBM180..... | 258, 448 |
| JBASE5..... | 185 | KBC20..... | 174 | LFTPWI2..... | 223 | MBSB11..... | 259, 447 |
| JBASE6..... | 185 | KBK5..... | 85 | LFTPWI3..... | 223 | MBSB17..... | 259, 447 |
| JBASE7..... | 185 | KBK7..... | 85 | LFTPW22..... | 225 | MBSB20..... | 259, 447 |
| JBASEA8..... | 186 | KBK9..... | 85 | LFTPW24..... | 225 | MBW93..... | 61 |
| JBASEM9..... | 186 | KNF2..... | 59 | LFTTSB17..... | 225 | MC41..... | 60 |
| JBASEMEL8..... | 185, 368 | KNF3..... | 59 | LFTTSRRB..... | 225 | MC61..... | 60 |
| JBOD5..... | 187 | KNF4..... | 59 | LFTTSRRS..... | 225 | MC81..... | 60 |
| JBOD12..... | 187 | KNF6..... | 59 | LFTTSW17..... | 225 | MCADDY..... | 150, 429 |
| JC8..... | 73, 342 | KNF7..... | 59 | LFTW63..... | 223 | MCB10GM..... | 17 |
| JC11..... | 73, 342 | KNF8..... | 59 | LFTW65..... | 223 | MCB10GR..... | 17 |
| JC12..... | 73, 342 | KSMC6..... | 174 | LFTW67..... | 223 | MCB10MA..... | 17 |
| JC14..... | 73, 342 | KSMC10..... | 174 | LGJ6..... | 65 | MCB10WH..... | 17 |
| JC16..... | 73, 342 | KSMC12..... | 174 | LGJ8..... | 64, 65 | MCB12GM..... | 17 |
| JCOV1..... | 188 | KSMC20..... | 174 | LGJ24..... | 64, 65 | MCB12GR..... | 17 |
| JCOV3..... | 185 | L210..... | 379 | LGJ40..... | 64, 65 | MCB12MA..... | 17 |
| JCOV4..... | 185 | L215..... | 379 | LGMB3..... | 67 | MCB12WH..... | 17 |
| JCOV6..... | 169 | L220..... | 379 | LGMB16..... | 67 | MCB16GM..... | 17 |
| JCOV8..... | 187 | L1101..... | 379 | LGMB68..... | 67 | MCB16GR..... | 17 |
| JCOV12..... | 187 | L1102..... | 379 | LK50..... | 316 | MCB16MA..... | 17 |
| JFAUC4..... | 188 | L1103..... | 379 | LMJ1622..... | 66 | MCB16WH..... | 17 |
| JFAUC5..... | 185 | L1104..... | 379 | LMJ1785..... | 66 | MCB24GM..... | 17 |
| JFAUC8..... | 169, 187 | L1105..... | 379 | LN722..... | 160 | MCB24GR..... | 17 |
| JG1..... | 352 | L1106..... | 379 | LNC602..... | 160 | MCB24MA..... | 17 |
| JG2..... | 352 | L1107..... | 379 | LPITP1413..... | 443 | MCB24WH..... | 17 |
| JG2A..... | 352 | L1108..... | 379 | LPITP1422..... | 443 | MCB36GM..... | 17 |
| JG3..... | 352 | L1112..... | 379 | LPITP1438..... | 443 | MCB36GR..... | 17 |
| JG4..... | 352, 356 | L11005..... | 379 | LPITP1446..... | 443 | MCB36MA..... | 17 |
| JG5..... | 352, 356 | L11015..... | 379 | LPLT10..... | 90 | MCB36WH..... | 17 |
| JG12..... | 352 | LBO27..... | 374 | LPLTG10..... | 90 | MCB300..... | 121 |
| JG14..... | 352 | LDCC16..... | 106 | LRGJ6..... | 65 | MCB500..... | 121 |
| JG22..... | 352 | LDCC17..... | 106 | LSB3..... | 359 | MCBPPBOXAN..... | 323 |
| JG63..... | 352 | LDCC18..... | 106 | LSBO..... | 359 | MCBPPBSS..... | 323 |
| JGB4..... | 356 | LDLB2613..... | 95 | LT12..... | 386 | MCBRRPBL..... | 323 |
| JGB5..... | 356 | LDLC1362..... | 95 | LT12ST..... | 386 | MCC300..... | 121 |
| JGG4..... | 356 | LFRY43..... | 90 | LT14..... | 386 | MCC500..... | 121, 122 |
| JGG5..... | 356 | LFRY44..... | 90 | LT14P..... | 386 | MCCRRPBL..... | 323 |
| JMART15..... | 339 | LFRY54..... | 90 | LT14ST..... | 386 | MCCRLSBL..... | 323 |
| JREP3..... | 188 | LFRY55..... | 90 | LT20..... | 386 | MCG300..... | 121 |
| JREP4..... | 185 | LFRYG43..... | 90 | LT198..... | 386 | MCG500..... | 121 |
| JREP5..... | 185 | LFRYG44..... | 90 | LWUS779..... | 277, 433 | MCHB125..... | 315 |
| JREP6..... | 169 | LFRYG54..... | 90 | LWUSR..... | 277, 433 | MCHW125..... | 315 |
| JS6..... | 359 | LFRYG55..... | 90 | LX306..... | 147, 428 | MCL4..... | 382 |
| JSTRN6..... | 188 | LFTB63..... | 223 | LX307..... | 147, 428 | MCL10..... | 382 |
| JSTRN8..... | 187 | LFTB65..... | 223 | M30SP..... | 150, 429 | MCL12..... | 382 |
| JSTRN12..... | 187 | LFTB67..... | 223 | M312T..... | 150, 429 | MCL13..... | 382 |
| JTUBE3..... | 185 | LFTBB8..... | 222 | M316T..... | 150, 429 | MCL14..... | 382 |
| JTUBE4..... | 185 | LFTBB9..... | 222 | M317T..... | 150, 429 | MCL75..... | 382 |
| JTUBE5..... | 188 | LFTBB12..... | 224 | MACD3..... | 172 | MCL125..... | 382 |
| JTUBE6..... | 169 | LFTBB16..... | 224 | MACTOP..... | 172 | MCL150..... | 382 |
| JTUBE8..... | 187 | LFTBW8..... | 222 | MART1..... | 339 | MCL175..... | 382 |
| JTUBE12..... | 187 | LFTBW9..... | 222 | MAW10..... | 355 | MCL200..... | 382 |

| | | | | | | | |
|---------------|---------|-----------------|----------|---------------|----------|---------------|---------|
| MCP6GM..... | 17 | MELR9..... | 48, 209 | MMOB1..... | 140 | MRF450BL..... | 143 |
| MCP6GR..... | 17 | MELR11..... | 48, 209 | MMOB2..... | 140 | MRF450W..... | 143 |
| MCP6MA..... | 17 | MELRC3..... | 209 | MMOB3..... | 140 | MRP7CL..... | 29 |
| MCP6WH..... | 17 | MELSC15..... | 143 | MMOB25..... | 140 | MRP7TC..... | 29 |
| MCP9GM..... | 17 | MELSC20..... | 143 | MMP6..... | 140 | MRP9CL..... | 29 |
| MCP9GR..... | 17 | MELSCB21..... | 143 | MMP8..... | 140 | MRP9TC..... | 29 |
| MCP9MA..... | 17 | MELSCB51..... | 143 | MP6..... | 48 | MRP11CL..... | 29 |
| MCP9WH..... | 17 | MELSL52..... | 211 | MP7..... | 48 | MRP11TC..... | 29 |
| MCP11GM..... | 17 | MELSL82..... | 211 | MP9..... | 48 | MRP53..... | 55 |
| MCP11GR..... | 17 | MELSL92..... | 211 | MP11..... | 48 | MRPS45..... | 55 |
| MCP11MA..... | 17 | MELSL112..... | 211 | MP1116..... | 449 | MRPT3CL..... | 29 |
| MCP11WH..... | 17 | MELSQ6..... | 209 | MPI217..... | 449 | MRPT3TC..... | 29 |
| MCP12GM..... | 17 | MELSQ8..... | 209 | MPI222..... | 449 | MRPT4CL..... | 29 |
| MCP12GR..... | 17 | MELSQ10..... | 209 | MPI318..... | 449 | MRPT4TC..... | 29 |
| MCP12MA..... | 17 | MELSQ53..... | 210 | MPI419..... | 449 | MRPT6CL..... | 29 |
| MCP12WH..... | 17 | MELSQ73..... | 210 | MPI424..... | 449 | MRPT6TC..... | 29 |
| MCR72..... | 60 | MELSQ94..... | 210 | MPI520..... | 449 | MRS150BL..... | 143 |
| MCRW72..... | 61 | MELSQ117..... | 210 | MPI621..... | 449 | MRS150W..... | 143 |
| MCTRBPBL..... | 323 | MESA72C..... | 170 | MPI626..... | 449 | MRS200BL..... | 99, 143 |
| MCTRLSBL..... | 323 | MESA72H..... | 170 | MPI722..... | 449 | MRS200W..... | 99, 143 |
| MCW4..... | 382 | MESA91C..... | 170 | MPI823..... | 449 | MRS300BL..... | 143 |
| MCW10..... | 382 | MESA91H..... | 170 | MPI826..... | 449 | MRS300W..... | 143 |
| MCW12..... | 382 | MESABUCH13..... | 171 | MPCUT4..... | 439 | MRS400BL..... | 143 |
| MCW13..... | 382 | MESABUSH13..... | 171 | MPCUT6..... | 439 | MRS400W..... | 143 |
| MCW14..... | 382 | MFP41..... | 60 | MPL4..... | 54 | MRS600BL..... | 143 |
| MCW41..... | 61 | MFP81..... | 60 | MPL8..... | 54 | MRS600W..... | 143 |
| MCW61..... | 61 | MFPW41..... | 61 | MPL14..... | 54 | MRSW6..... | 218 |
| MCW75..... | 382 | MFPW81..... | 61 | MPL24..... | 54 | MRSW9..... | 218 |
| MCW81..... | 61 | MFRYBSKT..... | 89 | MPLA..... | 241 | MRSW12..... | 218 |
| MCW125..... | 382 | MG578..... | 351 | MPLB..... | 241 | MRSW13..... | 218 |
| MCW150..... | 382 | MGC20..... | 345 | MPLW..... | 241 | MRW615..... | 218 |
| MCW175..... | 382 | MGC25..... | 345 | MPNS..... | 439 | MRW815..... | 218 |
| MCW200..... | 382 | MGD20..... | 345 | MPS10..... | 355 | MRW1215..... | 218 |
| MDLR7..... | 355 | MGD25..... | 345 | MPS12..... | 386 | MSB2..... | 259 |
| MDLR10..... | 355 | MGL20..... | 345 | MPS14..... | 54 | MSB3..... | 259 |
| MDT9B..... | 275 | MGL25..... | 345 | MPS22..... | 54 | MSB4..... | 259 |
| MDT9W..... | 275 | MGLA3..... | 150, 429 | MPSB16..... | 259, 447 | MSC8..... | 33, 141 |
| MDT12B..... | 275 | MGLCS..... | 150, 429 | MPT12..... | 386 | MSCR2..... | 142 |
| MDT12W..... | 275 | MH220..... | 308 | MRB6CL..... | 29 | MSCRW2..... | 142 |
| MEL5..... | 212 | MH243..... | 308 | MRB6TC..... | 29 | MSCSB3..... | 142 |
| MEL7..... | 212 | MHSC6..... | 312 | MRB10CL..... | 29 | MSCSW3..... | 142 |
| MEL9..... | 212 | MICH5..... | 75 | MRB10TC..... | 29 | MSEA10B..... | 274 |
| MEL12..... | 215 | MICH10..... | 75 | MRB13CL..... | 29 | MSEA10G..... | 274 |
| MEL19..... | 215 | MICH15..... | 75, 342 | MRB13TC..... | 29 | MSEA10S..... | 274 |
| MEL21..... | 215 | MICH25..... | 75 | MRB22CL..... | 29 | MSEA12B..... | 274 |
| MEL22..... | 212 | MJ16..... | 66 | MRB22TC..... | 29 | MSEA12G..... | 274 |
| MEL23..... | 215 | MJ17..... | 66, 342 | MRCW6..... | 218 | MSEA12S..... | 274 |
| MEL42..... | 215 | MJ22..... | 66 | MRCW7..... | 218 | MSJ3..... | 64 |
| MEL43..... | 215 | MJ85..... | 66, 342 | MRCW9..... | 218 | MSJ4..... | 64 |
| MEL44..... | 215 | MLRP9..... | 210 | MRCW10..... | 218 | MSJ5..... | 64, 286 |
| MEL49..... | 215 | MLRP13..... | 210 | MRCW12..... | 218 | MSP4..... | 147 |
| MEL50..... | 215 | MLRP17..... | 210 | MRCW13..... | 218 | MSP61..... | 62 |
| MEL148..... | 214 | MLRP19..... | 210 | MRDB14..... | 220 | MSP91..... | 62 |
| MEL189..... | 214 | MLRS9..... | 211 | MREC13..... | 220 | MSPW61..... | 62 |
| MEL1414..... | 214 | MLRS12..... | 211 | MREC21..... | 220 | MSPW91..... | 62 |
| MEL2113..... | 214 | MLRS16..... | 211 | MRECB13..... | 220 | MSQBSKT..... | 89 |
| MELBPH..... | 142 | MLRS21..... | 211 | MRECB21..... | 220 | MSSF75..... | 383 |
| MELPOT2..... | 64 | MM12WH..... | 17 | MRECBSKT..... | 91 | MSSR74..... | 383 |
| MELPOT8..... | 64 | MM100..... | 351 | MRF150BL..... | 143 | MSSS73..... | 383 |
| MELPOT14..... | 64 | MMB3..... | 140 | MRF150W..... | 143 | MSTNG5..... | 353 |
| MELPOT24..... | 64 | MMB6..... | 140 | MRF250BL..... | 99, 143 | MT6..... | 219 |
| MELR5..... | 48, 209 | MMB9..... | 140 | MRF250W..... | 99, 143 | MT8..... | 219 |
| MELR6..... | 48, 209 | MMBH3..... | 140 | MRF350BL..... | 143 | MT10..... | 219 |
| MELR8..... | 48, 209 | MMBH7..... | 140 | MRF350W..... | 143 | MTB20..... | 242 |

| | | | | | | | |
|--------------|---------------|--------------|---------|---------------|----------|---------------|----------|
| MTB156..... | 177, 286 | MWW10..... | 355 | OSC9..... | 96 | PBSB1512..... | 452 |
| MTB159..... | 177 | N9494..... | 425 | OSCAR..... | 75, 127 | PBSL1..... | 215, 246 |
| MTB296..... | 177 | NB30..... | 229 | OSCAR2..... | 75, 127 | PBSL2..... | 215, 246 |
| MTB298..... | 177 | NB32..... | 229 | OSCAR3..... | 75, 127 | PBSL3..... | 215, 246 |
| MTB1512..... | 177, 286 | NB50..... | 229 | OVJ1..... | 158 | PC0600S..... | 164 |
| MTB2910..... | 177 | NB56..... | 229 | OVJ2..... | 158 | PC0688S..... | 164 |
| MTP10..... | 214, 419 | NB85..... | 229 | OVJS..... | 158 | PC0788S..... | 164 |
| MTP12..... | 214, 419 | NB120..... | 229 | OWB107..... | 254 | PC0825S..... | 164 |
| MTP14..... | 214, 220, 419 | NBW30..... | 229 | OWB116..... | 252 | PC0875S..... | 164 |
| MTP16..... | 214, 419 | NBW32..... | 229 | OWB117..... | 252 | PC0900S..... | 164 |
| MTP18..... | 214, 419 | NBW50..... | 229 | OWB118..... | 252 | PC0950R..... | 164 |
| MTS20..... | 344 | NBW56..... | 229 | OWB129..... | 254 | PC0988S..... | 164 |
| MTS26..... | 344 | NBW85..... | 229 | OWB149..... | 252 | PC1025S..... | 164 |
| MTS32..... | 344 | NBW120..... | 229 | OWB208..... | 253 | PC1062E..... | 164 |
| MTSH1..... | 51 | NCB95..... | 287 | OWB1810..... | 253 | PC1068R..... | 164 |
| MTSH3..... | 51 | NCS36..... | 396 | OWB2213..... | 253 | PC1068S..... | 164 |
| MTSH5..... | 51 | NHS66..... | 262 | OWBB1..... | 255 | PC1093E..... | 164 |
| MTUB7..... | 109 | NHS95..... | 262 | OWBB2..... | 255 | PC1093R..... | 164 |
| MTUB10..... | 80 | NP14..... | 228 | OWBB8..... | 256 | PC1112R..... | 164 |
| MTUB12..... | 80 | NP18..... | 228 | OWBB9..... | 256 | PC1112S..... | 164 |
| MTUB63..... | 80 | NP21..... | 228 | OWBB15..... | 256 | PC1150S..... | 164 |
| MTUB69..... | 80 | NPW14..... | 228 | OWBG8..... | 256 | PC1175R..... | 164 |
| MTUB83..... | 80 | NPW18..... | 228 | OWBG9..... | 256 | PC1206R..... | 164 |
| MTUB93..... | 80 | NPW21..... | 228 | OWBG15..... | 256 | PC1244R..... | 164 |
| MTW6..... | 219 | NSB1..... | 312 | OWBS..... | 364 | PC1250S..... | 164 |
| MTW8..... | 219 | NSB4..... | 312 | OWLP..... | 254 | PC1300S..... | 164 |
| MTW10..... | 219 | NSB6..... | 312 | OWM10..... | 237 | PC7250..... | 437 |
| MTW20..... | 242 | NSB8..... | 312 | OWM12..... | 237 | PC7400..... | 437 |
| MW14..... | 235 | NSB10..... | 309 | OWM14..... | 237 | PCA3..... | 437 |
| MW17..... | 235 | NSB12..... | 312 | OWM17..... | 237 | PCG2..... | 132 |
| MW18..... | 234, 285 | NSB20..... | 309 | OWM21..... | 237 | PCG9..... | 383 |
| MW21..... | 235 | NSB30..... | 309 | OWM25..... | 237 | PCI10..... | 371 |
| MW24..... | 234, 285 | NSB40..... | 309 | OWM171..... | 237 | PCP12..... | 165 |
| MW25..... | 235 | NSB50..... | 309 | OWMP..... | 254 | PCR25..... | 118 |
| MW32..... | 234, 285 | NSC1..... | 312 | OWP9..... | 252, 446 | PCR55..... | 118 |
| MW171..... | 235 | NSC4..... | 312 | OWP12..... | 253 | PCSC6..... | 384 |
| MW1210..... | 297 | NSC6..... | 312 | OWP13..... | 252, 446 | PCSC12..... | 384 |
| MW2012..... | 297 | NSC8..... | 312 | OWP14..... | 253 | PCSC24..... | 384 |
| MWB11..... | 234 | NSC10..... | 309 | OWP15..... | 252, 446 | PCW2..... | 437 |
| MWB12..... | 234 | NSC12..... | 312 | OWP17..... | 252, 446 | PCW4..... | 437 |
| MWB14..... | 234 | NSC20..... | 309 | OWP18..... | 253 | PCW5..... | 437 |
| MWC57..... | 362 | NSC30..... | 309 | OWP157..... | 252 | PCWH2..... | 132 |
| MWC59..... | 362 | NSC40..... | 309 | OWP178..... | 252 | PFB6..... | 202 |
| MWMEL12..... | 233 | NSC50..... | 309 | OWPB9..... | 255 | PFB8..... | 202 |
| MWMEL19..... | 233 | NSPDS6..... | 380 | OWPB16..... | 255 | PFB10..... | 202 |
| MWMEL21..... | 233 | NSPDS8..... | 380 | OWPIT54..... | 116 | PHBS10..... | 385 |
| MWMEL23..... | 233 | NSPDS10..... | 380 | OWSP..... | 254 | PHBS14..... | 385 |
| MWMSQ5..... | 233 | NSPDS12..... | 380 | PB1914..... | 452 | PHBS16..... | 385 |
| MWMSQ7..... | 233 | NSPDS16..... | 380 | PB1926..... | 452 | PIZG3..... | 437 |
| MWMSQ9..... | 233 | NSPDS20..... | 380 | PBB8..... | 204 | PIZR2..... | 437 |
| MWMSQ11..... | 233 | NSPDS24..... | 380 | PBB9..... | 204 | PIZWI..... | 437 |
| MWP4..... | 250 | NSPDS30..... | 380 | PBB12..... | 204 | PKR20..... | 438 |
| MWP5..... | 250 | NSPDS40..... | 380 | PBB13..... | 204 | PKS8..... | 358 |
| MWP9..... | 250 | NSPDS50..... | 380 | PBB135..... | 204 | PKW8..... | 358 |
| MWP12..... | 250 | O2BWB..... | 364 | PBBAG19..... | 452 | PL147..... | 436 |
| MWP13..... | 250 | OBS58..... | 102 | PBBAG26..... | 452 | PLA710..... | 57 |
| MWP14..... | 250 | OBS69..... | 102 | PBBL2..... | 119 | PLA810..... | 57 |
| MWP18..... | 251, 285 | OBS913..... | 102 | PBBL4..... | 119 | PLA912..... | 57 |
| MWP24..... | 251, 285 | OLB9..... | 96 | PBB09..... | 204 | PLP147..... | 436 |
| MWP32..... | 251, 285 | OLID..... | 75, 127 | PBC25..... | 118 | PMBL8..... | 157 |
| MWPC6X2..... | 438 | OLID2..... | 75, 127 | PBC45..... | 118 | PMBL12..... | 157 |
| MWPD5..... | 251 | OLID3..... | 75, 127 | PBDX1805..... | 452 | PMG6..... | 156 |
| MWPD6..... | 251 | ORHC1..... | 99 | PBDX2005..... | 452 | PMKNOB..... | 156, 157 |
| MWR3..... | 297 | ORH02..... | 99 | PBL7..... | 119 | PMSA62..... | 156 |

| | | | | | | | | | |
|------------------|----------|----------------|----------|--------------------|----------|------------------|----------|---------------|----------|
| PMSBA62..... | 156 | PSBI416..... | 421 | RC5..... | 371 | RSG3..... | 292 | SBDL85..... | 324 |
| PMSBL62..... | 157 | PSBL..... | 119 | RCR13..... | 220 | RSGB3..... | 291 | SBDM85..... | 324 |
| PMSKNOB..... | 157 | PSD10..... | 436 | RCR21..... | 220 | RSGG3..... | 291 | SBH3..... | 82, 261 |
| PMSR62..... | 156 | PSFSP..... | 387 | RCRD14..... | 220 | RSGS3..... | 291 | SBH5..... | 82, 261 |
| PMSS62..... | 157 | PSG127..... | 436 | RD412..... | 166 | RSH1..... | 292 | SBH7..... | 82, 261 |
| PMSW62..... | 156 | PSLT2..... | 133, 153 | REVLJUICESQ12..... | 169 | RSLWCH..... | 330 | SBH325..... | 82, 261 |
| PNS13..... | 152 | PSLT17..... | 133, 153 | REVLSCUI2..... | 169 | RSM2..... | 296 | SBH400..... | 82, 261 |
| PNS24..... | 152 | PSP2..... | 153 | REVLRD20..... | 168 | RSQB2..... | 290 | SBH450..... | 82, 261 |
| POR9..... | 201 | PSP4..... | 204 | REVLRD20BASE..... | 168 | RSQG2..... | 290 | SBH575..... | 82, 261 |
| POR17..... | 201 | PSP8..... | 204 | REVLRT26..... | 168 | RSR10..... | 279, 434 | SBHW5..... | 306 |
| PORB29..... | 134 | PSP12..... | 204 | REVLRT26BASE..... | 168 | RSR307..... | 434 | SBL353..... | 126 |
| PORB30..... | 134 | PSPH3..... | 126 | REVLURN12..... | 169 | RSR312..... | 434 | SBN3..... | 77 |
| PORD39..... | 134 | PSPH4..... | 126 | RFPI8RD..... | 168, 172 | RSRB..... | 279, 434 | SBN4..... | 77 |
| PORS136..... | 203 | PSPL8..... | 204 | RG6..... | 289 | RSRB3..... | 279, 434 | SB0154..... | 374 |
| PORS140..... | 203 | PSPL12..... | 204 | RG7..... | 289 | RSRB4..... | 279, 434 | SBP30..... | 439 |
| PORS3R..... | 132 | PSR7..... | 435 | RG5341..... | 376 | RSRB7..... | 279, 434 | SBR5..... | 306 |
| PPC2..... | 437 | PSS12..... | 421 | RGB7..... | 433 | RSRB8..... | 275 | SBS533..... | 126 |
| PPC4..... | 437 | PSS15..... | 421 | GG7..... | 433 | RSRBH4..... | 279, 434 | SBSB135..... | 324 |
| PPC5..... | 437 | PSS77..... | 435 | RGJ4..... | 65 | RSRBH7..... | 279, 434 | SBSBL120..... | 324 |
| PPCHIB..... | 76 | PTBC..... | 159 | RGJ6..... | 65 | RSRTBK..... | 328 | SBSBMNI..... | 320 |
| PPCH2N..... | 76 | PTBR..... | 159 | RGS7..... | 433 | RSRTBLC8..... | 328 | SBSM135..... | 324 |
| PPCH3N..... | 76 | PTC..... | 194 | RHG1..... | 292 | RSRTBLC9..... | 328 | SBW3..... | 77 |
| PPCH3R..... | 76 | PTCC..... | 159 | RHSSIGNBLK..... | 329 | RSRTGY..... | 328 | SBW4..... | 77 |
| PPCH4N..... | 76, 431 | PTCR..... | 159 | RHSSIGNLSPS..... | 329 | RSRTLWCH..... | 328 | SBW5..... | 354 |
| PPCHARDWARE..... | 437 | PTS9..... | 194 | RM10..... | 238 | RSRTRD..... | 328 | SBW7..... | 354 |
| PPCN1010..... | 76 | PTUB87..... | 80 | RM12..... | 238 | RSRTRVSBLC4..... | 328 | SBW9..... | 354 |
| PPCN1212..... | 76 | PW10..... | 379 | RM13..... | 239 | RSRTRVSC3..... | 328 | SBW10..... | 354 |
| PPCN1616..... | 76 | PW12..... | 379 | RM14..... | 238 | RSRTRVSGYC2..... | 328 | SCAR9..... | 433 |
| PPK17..... | 438 | PW14..... | 379 | RM17..... | 238 | RSRTRVSRDC1..... | 328 | SCAT9..... | 433 |
| PPL4..... | 77 | PW16..... | 379 | RM21..... | 238 | RSRW8..... | 275 | SCAW7..... | 104, 426 |
| PPL7..... | 77 | PW18..... | 379 | RM25..... | 238 | RSS3..... | 292 | SCB3..... | 72 |
| PPL12..... | 77 | PWB3..... | 130 | RM95..... | 239 | RSSB3..... | 279, 434 | SCB480..... | 103 |
| PPRC76..... | 76 | PWB45..... | 130 | RM147..... | 239 | RSSB7..... | 279, 434 | SCBL..... | 173 |
| PPRN76..... | 76 | PWBB3..... | 130 | RM189..... | 239 | RSSIGNBLK..... | 329 | SCBM..... | 72 |
| PPRN1100..... | 76 | PWBB10..... | 84 | RM210..... | 239 | RSSIGNLSPS..... | 329 | SCF2..... | 173 |
| PPRN1616..... | 76, 431 | PWBB12..... | 84 | RM1614..... | 239 | RSSPH2..... | 122 | SCG8..... | 383 |
| PPRN2121..... | 76 | PWBB45..... | 130 | RM2113..... | 239 | RTSSPH3..... | 122 | SCH6..... | 105 |
| PPRW1010..... | 76 | PWBC7..... | 130 | RMB11..... | 238 | RTWVY1..... | 199 | SCH7..... | 105 |
| PPRW1212..... | 76 | PWBC8..... | 130 | RMB12..... | 238 | RWW8..... | 392 | SCH8..... | 105 |
| PPRW1616..... | 76, 431 | PWBS4..... | 130 | RMB14..... | 238 | S208..... | 359 | SCHB6..... | 105 |
| PPSS837..... | 443 | PWC7..... | 130 | RMB59C..... | 91 | S209..... | 359 | SCHB7..... | 105 |
| PPSS849..... | 443 | PWC8..... | 130 | RMB95B..... | 91 | SAC35..... | 313 | SCHB8..... | 105 |
| PRI8..... | 423 | PWK19..... | 438 | ROB2613..... | 95 | SAC40..... | 313 | SCM2..... | 122 |
| PRP500..... | 423 | PWRB10..... | 84 | ROC1362..... | 95 | SAN300..... | 149, 430 | SCM3..... | 120 |
| PRS2..... | 158 | PWRB12..... | 84 | RP5718..... | 423 | SAN312..... | 149, 430 | SCM4..... | 120 |
| PRS14..... | 438 | PWS4..... | 130 | RRB2..... | 290 | SAN316..... | 149, 430 | SCM6..... | 120 |
| PRS22..... | 438 | RAM1..... | 161 | RRG2..... | 290 | SAN317..... | 149, 430 | SCMB3..... | 120 |
| PRSD3..... | 133 | RB15..... | 135 | RS12..... | 308 | SAN318..... | 149, 430 | SCMB4..... | 120 |
| PS10..... | 387, 436 | RB25..... | 135 | RS18..... | 308 | SAN319..... | 149, 430 | SCMB6..... | 120 |
| PS12..... | 386 | RBHB975..... | 109 | RSB1..... | 296 | SBI..... | 260 | SCMC3..... | 120 |
| PS12ST..... | 386 | RBHC759..... | 109 | RSB307..... | 434 | SB3..... | 83, 260 | SCMC4..... | 120 |
| PS14..... | 386 | RBHMSG..... | 329 | RSB312..... | 434 | SB5..... | 83, 260 | SCMC6..... | 120 |
| PS14P..... | 386 | RBHSIGNBL..... | 327 | RSBPBL..... | 328 | SB7..... | 83, 260 | SCMG3..... | 120 |
| PS125..... | 421 | RBHSIGNS..... | 327 | RSC1..... | 135 | SB325..... | 83, 260 | SCMG4..... | 120 |
| PS127..... | 436 | RBNB16..... | 108 | RSC3..... | 135 | SB400..... | 83, 260 | SCMG6..... | 120 |
| PS196..... | 387, 436 | RBNB17..... | 108 | RSC4..... | 135 | SB450..... | 83, 260 | SCP8..... | 165 |
| PS197..... | 387 | RBNC26..... | 108 | RSCLC..... | 330 | SB575..... | 83, 260 | SCP65..... | 165 |
| PS1116..... | 421 | RBNC27..... | 108 | RSCLCHB1..... | 330 | SBB3..... | 77 | SCRACK5..... | 166 |
| PS1416..... | 421 | RBR3..... | 298 | RSCLCHB2..... | 330 | SBB4..... | 77 | SCS3..... | 72 |
| PS1575..... | 421 | RBSBL..... | 326 | RSCLG..... | 330 | SBBL..... | 177 | SCSM..... | 72 |
| PS19008..... | 387 | RBSIGNBL..... | 327 | RSCLG0A1..... | 330 | SBBS..... | 177 | SD10..... | 150 |
| PS19075..... | 387 | RBSIGNS..... | 327 | RSCLG0A2..... | 330 | SBC5..... | 306 | SD3511..... | 159 |
| PSA105..... | 437 | RBSS..... | 326 | RSCLRPCHBL..... | 330 | SBD5..... | 306 | SDRCK..... | 277, 432 |
| PSB16..... | 421 | RBVMSG..... | 329 | RSCLRPGOBL..... | 330 | SBD85..... | 324 | SDRCK4..... | 277, 432 |

| | | | | | | | | | |
|--------------|----------|-----------------|---------|---------------|----------|--------------|---------|--------------|----------|
| SDRCKV4..... | 276 | SLR8..... | 226 | SPP326..... | 126 | SQVY5..... | 202 | SSP16..... | 19, 418 |
| SDRCKV7..... | 276 | SLS5..... | 227 | SPPLUGS..... | 155 | SQVY8..... | 202 | SSP25..... | 75 |
| SDWB40..... | 268 | SLS6..... | 227 | SPR725..... | 396 | SQVY10..... | 202 | SSP35..... | 75 |
| SDWB45..... | 268 | SLWC2..... | 362 | SPRV1..... | 325 | SQVY12..... | 202 | SSP43..... | 75 |
| SDWB55..... | 268 | SM9..... | 354 | SPRV2..... | 325 | SR6063..... | 393 | SSP61..... | 75 |
| SDWC7..... | 363 | SMA100WT..... | 321 | SPS11..... | 195 | SR6073..... | 393 | SSP120..... | 195 |
| SDWP64..... | 114 | SMA510V4..... | 321 | SPSSWM2..... | 325 | SR6083..... | 393 | SSPH2..... | 122 |
| SDWW5..... | 363 | SMA510V4WT..... | 321 | SPT14..... | 195 | SR6093..... | 393 | SSPH4..... | 122 |
| SEA10..... | 270 | SMA510WT..... | 321 | SQ600..... | 416 | SR6103..... | 393 | SSPT3..... | 122 |
| SEA12..... | 270 | SMB3..... | 15, 138 | SQ610..... | 416 | SRBNC1..... | 107 | SSPT5..... | 122 |
| SEA14..... | 270 | SMB4..... | 15, 138 | SQ615..... | 416 | SRBNC2..... | 107 | SSQ53..... | 267 |
| SEA16..... | 270 | SMB5..... | 15, 138 | SQ620..... | 416 | SRCH4..... | 315 | SSQ73..... | 267 |
| SEA18..... | 270 | SMB6..... | 15 | SQ800..... | 416 | SRCH125..... | 315 | SSQ94..... | 267 |
| SEA20..... | 270 | SMB10..... | 15 | SQ810..... | 416 | SRG3..... | 289 | SSQ117..... | 267 |
| SECSTN5..... | 320, 321 | SMP4..... | 15 | SQ815..... | 416 | SRG4..... | 289 | SSQH53..... | 267 |
| SGLR..... | 150 | SMP6..... | 15 | SQ820..... | 416 | SRS3..... | 289 | SSQH73..... | 267 |
| SGSC16..... | 175 | SMP9..... | 15 | SQ1000..... | 416 | SRS4..... | 289 | SSQH94..... | 267 |
| SGSC17..... | 175 | SMP11..... | 15 | SQ1010..... | 416 | SS59..... | 86 | SSQH117..... | 267 |
| SGSC26..... | 175 | SMS1..... | 307 | SQ1015..... | 416 | SS92..... | 86 | SSR4..... | 294 |
| SHFF12..... | 192 | SMSC4..... | 349 | SQ1020..... | 416 | SS782..... | 388 | SSR5..... | 306 |
| SHFL9..... | 192 | SMSC8..... | 349 | SQ1200..... | 416 | SSB28..... | 101 | SSR8..... | 294 |
| SHFPS11..... | 192 | SMSR4..... | 349 | SQ1210..... | 416 | SSB75..... | 392 | SSR12..... | 294 |
| SHFSA9..... | 192 | SMSR8..... | 349 | SQ1215..... | 416 | SSB96..... | 101 | SSRT962..... | 91 |
| SHFSP7..... | 192 | SN60..... | 160 | SQ1220..... | 416 | SSB150..... | 392 | SSSK..... | 59 |
| SHFSP12..... | 192 | SNC1..... | 312 | SQ1400..... | 416 | SSB200..... | 392 | SST10..... | 262 |
| SHFSS12..... | 192 | SNF700..... | 160 | SQ1410..... | 416 | SSB300..... | 392 | SST12..... | 262 |
| SHFT6..... | 192 | SNT612..... | 160 | SQ1415..... | 416 | SSB400..... | 392 | SST14..... | 262 |
| SHFT9..... | 192 | SOCH..... | 317 | SQ1420..... | 416 | SSB500..... | 392 | SSUS1..... | 277, 433 |
| SHFT11..... | 192 | SP4..... | 155 | SQ1600..... | 416 | SSB800..... | 392 | ST2..... | 146, 427 |
| SHSP20..... | 55 | SP6..... | 155 | SQ1610..... | 416 | SSB1300..... | 392 | ST10..... | 262 |
| SHSP21..... | 55 | SP8MN..... | 63 | SQ1615..... | 416 | SSB1600..... | 392 | ST12..... | 262 |
| SHSP32..... | 55 | SP8SH..... | 63 | SQ1620..... | 416 | SSB2000..... | 392 | ST20..... | 262 |
| SHSP40..... | 55 | SP10MN..... | 63 | SQB55..... | 201 | SSBT11..... | 361 | STC2..... | 359 |
| SHSP41..... | 55 | SP10SH..... | 63 | SQB88..... | 201 | SSBT14..... | 361 | STC4..... | 359 |
| SHSP53..... | 55 | SP29..... | 155 | SQFBBL..... | 87 | SSBV1..... | 122 | STH6..... | 368 |
| SHT8..... | 80 | SP35..... | 155 | SQFBCN..... | 87 | SSC5..... | 306 | STH8..... | 368 |
| SHT9..... | 80 | SP125..... | 152 | SQFBCN10..... | 87 | SSC15..... | 136 | STH14..... | 368 |
| SHT10..... | 80 | SP126..... | 152 | SQFBSS..... | 87 | SSC17..... | 385 | STH16..... | 368 |
| SHT17..... | 80 | SPC..... | 125 | SQGB6..... | 92 | SSC18..... | 385 | STONE12..... | 420 |
| SIGNC3..... | 306 | SPC2..... | 125 | SQGB10..... | 92 | SSC19..... | 385 | STONE13..... | 420 |
| SIGNC0..... | 306 | SPC3..... | 125 | SQGB12..... | 92 | SSC25..... | 136 | STONE14..... | 420 |
| SIGNCR1..... | 306 | SPDB1..... | 155 | SQGS6..... | 92 | SSCH4..... | 315 | STONE15..... | 420 |
| SIGND4..... | 306 | SPDB33..... | 155 | SQGS8..... | 92 | SSCH125..... | 315 | STP10..... | 78, 418 |
| SIGNHT1..... | 306 | SPDG11..... | 155 | SQGS10..... | 92 | SSD5..... | 306 | STP12..... | 78, 418 |
| SIGNIT2..... | 306 | SPDG33..... | 155 | SQGS12..... | 92 | SSEA10..... | 270 | STP14..... | 78, 418 |
| SIGNM8..... | 306 | SPDX11..... | 155 | SQND7..... | 200 | SSEA12..... | 270 | STP16..... | 78, 418 |
| SIGNR6..... | 306 | SPDX22..... | 155 | SQND9..... | 200 | SSEA14..... | 270 | STS2..... | 288 |
| SIGNS7..... | 306 | SPDX33..... | 155 | SQND11..... | 200 | SSEA16..... | 270 | STS3..... | 288 |
| SIGNSK9..... | 306 | SPH..... | 125 | SQND13..... | 200 | SSEA18..... | 270 | STUB10..... | 80 |
| SIGNW5..... | 306 | SPLB7..... | 151 | SQND15..... | 200 | SSFC7..... | 87 | STUB12..... | 80 |
| SKS514..... | 389 | SPLBCAP..... | 151 | SQP10..... | 214 | SSHW5..... | 306 | STUB20..... | 80, 369 |
| SKS714..... | 389 | SPM4..... | 155 | SQP12..... | 214 | SSKNF8..... | 59 | STUB63..... | 80 |
| SL74..... | 227 | SPN2..... | 381 | SQP16..... | 214 | SSKNF9..... | 59 | STUB69..... | 80 |
| SL76..... | 227 | SPN3..... | 381 | SQSC15..... | 133, 200 | SSMS9..... | 57 | STUB83..... | 80 |
| SL96..... | 227 | SPN4..... | 381 | SQSC20..... | 133, 200 | SSP2..... | 154 | STUB87..... | 80 |
| SLFTD8..... | 349 | SPN5..... | 381 | SQSC30..... | 133, 200 | SSP4..... | 19, 418 | STUB93..... | 80 |
| SLL1..... | 195 | SPN6..... | 381 | SQSC40..... | 133, 200 | SSP6..... | 19, 418 | SVHF..... | 191 |
| SLL2..... | 195 | SPN8..... | 381 | SQSSPH2..... | 122 | SSP8..... | 19, 418 | SVHF10..... | 191 |
| SLL4..... | 195 | SPNP2..... | 381 | SQVL712..... | 199 | SSP9..... | 19, 418 | SVHL..... | 191 |
| SLL6..... | 195 | SPNP3..... | 381 | SQVL914..... | 199 | SSP10..... | 19, 418 | SVHML..... | 191 |
| SLPI21..... | 195 | SPNP4..... | 381 | SQVY1..... | 133, 202 | SSP12..... | 19, 418 | SVHP10..... | 191 |
| SLR3..... | 226 | SPNP5..... | 381 | SQVY2..... | 133, 202 | SSP13..... | 19, 418 | SVHSA10..... | 191 |
| SLR5..... | 226 | SPNP6..... | 381 | SQVY3..... | 133, 202 | SSP14..... | 19, 418 | SVHSP..... | 191 |
| SLR6..... | 226 | SPNP8..... | 381 | SQVY4..... | 133, 202 | SSP15..... | 19, 418 | SVHSP6..... | 191 |

| | | | | | | | | | |
|---------------|----------|---------------|----------|---------------|---------|----------------|----------|-------------------|-----|
| SVHSP10..... | 191 | THMT3..... | 53 | TTMC3..... | 307 | UT707..... | 353, 388 | WLD11..... | 203 |
| SVHSS..... | 191 | THMT5..... | 53 | TTMEL3..... | 282 | UT975..... | 388 | WLD13..... | 203 |
| SVHSS10..... | 191 | THMW1..... | 53 | TTREC3..... | 282 | UT1200..... | 388 | WLD15..... | 203 |
| SVHT1..... | 191 | THMW3..... | 53 | TTRS3..... | 282 | UT1600..... | 388 | WMEL19..... | 242 |
| SVHT2..... | 191 | THMW5..... | 53 | TTRSMEL7..... | 282 | WB8C..... | 363 | WMEL21..... | 242 |
| SVHT6..... | 191 | THN61..... | 159 | TTS2319..... | 288 | WB9..... | 363, 365 | WMEL23..... | 242 |
| SWILAD..... | 194 | THOV19..... | 267 | TTSB3..... | 307 | WB32..... | 111, 348 | WP68..... | 113 |
| SW4..... | 269, 362 | THRC21..... | 267 | TTSVG3..... | 307 | WB33..... | 111, 348 | WP100..... | 113 |
| SW4C..... | 363 | THRD17..... | 267 | TV3..... | 85 | WB34..... | 111, 348 | WPH45153..... | 443 |
| SW6TNG..... | 194 | THW8..... | 53 | TV4..... | 85 | WB35..... | 111, 348 | WPM8..... | 157 |
| SW9SPN..... | 194 | TIM1..... | 127 | TV6..... | 85 | WBB..... | 323 | WPM12..... | 157 |
| SW9TNG..... | 194 | TIM2..... | 127 | TV8..... | 85 | WBB9..... | 100 | WPM18..... | 157 |
| SW10SP0..... | 194 | TLSP1219..... | 281, 435 | TV9..... | 85 | WBB11..... | 100 | WPMS62..... | 157 |
| SW12PAS..... | 194, 387 | TMW9..... | 217 | TWBB53..... | 243 | WBBM..... | 100 | WPSF33..... | 117 |
| SW12SL..... | 194 | TMW13..... | 217 | TWBB73..... | 243 | WBBR80..... | 100 | WPSF67..... | 117 |
| SW12SOL..... | 194 | TMW16..... | 217 | TWBB94..... | 243 | WBBS..... | 100 | WRPC5713..... | 423 |
| SWB..... | 364 | TONG2..... | 196 | TWBB124..... | 243 | WBBV90..... | 100 | WRPC5715..... | 423 |
| SWBSTND..... | 364 | TONG3..... | 196 | TWBREC..... | 243 | WBC34..... | 111, 348 | WRPC5718..... | 423 |
| SWC48..... | 362 | TOPPNS1..... | 152 | UBR5GE..... | 13 | WBC36..... | 111, 348 | WRPCHARDWARE..... | 423 |
| SWCH..... | 317 | TP6..... | 406 | UBR5M0..... | 13 | WBC705..... | 103 | WSB69..... | 101 |
| SWSC..... | 364 | TP7..... | 406 | UBR10GE..... | 13 | WBCAP..... | 111, 348 | WSB82..... | 101 |
| SZ56..... | 354 | TP8..... | 406 | UBR10M0..... | 13 | WBCC6..... | 106 | WSBL15..... | 206 |
| T10SDC..... | 383 | TP9..... | 406 | UBR16GE..... | 13 | WBCC7..... | 106 | WSBM11..... | 206 |
| T10SDF..... | 383 | TP10..... | 406 | UBR16M0..... | 13 | WBCC8..... | 106 | WSLB27..... | 206 |
| T10SDM..... | 383 | TP11..... | 406 | UBR24GE..... | 13 | WBCLINER..... | 97, 103 | WSMB17..... | 206 |
| T80061.5..... | 413 | TP12..... | 406 | UBR24M0..... | 13 | WBP34..... | 112, 348 | WSP15..... | 206 |
| T80062..... | 413 | TP13..... | 406 | UBR32GE..... | 13 | WBPCAP..... | 112, 348 | WSPR2B..... | 108 |
| T80071.5..... | 413 | TP14..... | 406 | UBR32M0..... | 13 | WBS24..... | 365 | WSPR3C..... | 108 |
| T80072..... | 413 | TP15..... | 406 | UBR48GE..... | 13 | WBSM42..... | 365 | WSRT21..... | 206 |
| T80081.5..... | 413 | TP16..... | 406 | UBR48M0..... | 13 | WBW80..... | 101 | WTBA6..... | 299 |
| T80082..... | 413 | TP17..... | 406 | UBRT10GE..... | 13 | WBW96..... | 101 | WTBA10..... | 299 |
| T80091.5..... | 413 | TP18..... | 406 | UBRT10M0..... | 13 | WBWBL4060..... | 324 | WTBA12..... | 299 |
| T80092..... | 413 | TP19..... | 406 | UBRT16GE..... | 13 | WBWBL6080..... | 324 | WTBA20..... | 299 |
| T80101.5..... | 413 | TP20..... | 406 | UBRT16M0..... | 13 | WC40..... | 112 | WTBL6..... | 301 |
| T80102..... | 413 | TPREC3..... | 282 | UBRT24GE..... | 13 | WCBA4..... | 131, 299 | WTBL10..... | 301 |
| T80112..... | 413 | TPRS..... | 356 | UBRT24M0..... | 13 | WCBA7..... | 131, 299 | WTBL12..... | 301 |
| T80121.5..... | 413 | TR18..... | 397 | UBS10GE..... | 12 | WCBL4..... | 131, 301 | WTBL20..... | 301 |
| T80122..... | 413 | TR24..... | 397 | UBS10M0..... | 12 | WCBL7..... | 131, 301 | WTSB33..... | 162 |
| T80132..... | 413 | TR30..... | 397 | UBS16GE..... | 12 | WCFS462..... | 362 | WTSB40..... | 162 |
| T80142..... | 413 | TR36..... | 397 | UBS16M0..... | 12 | WCMA..... | 360 | WTSM31..... | 162 |
| T80162..... | 413 | TR48..... | 397 | UBS60GE..... | 12 | WCRP..... | 360 | WTSM38..... | 162 |
| TAGA6WT..... | 319 | TRPZ12..... | 217 | UBS60M0..... | 12 | WCS137..... | 360 | WTSW32..... | 162 |
| TAGA7WT..... | 319 | TRPZ18..... | 217 | UM12GE..... | 12 | WCS867..... | 360 | WTSW39..... | 162 |
| TAGA8WT..... | 319 | TRPZ23..... | 217 | UM12M0..... | 12 | WCS871..... | 360 | WTV6..... | 300 |
| TASLG..... | 280 | TRSD1815..... | 162 | UPLR10GE..... | 13 | WCSB415..... | 360 | WTV10..... | 300 |
| TASMED..... | 280 | TRSH12..... | 397 | UPLR10M0..... | 13 | WCV4..... | 131, 300 | WTV12..... | 300 |
| TASSM..... | 280 | TRSH18..... | 397 | UPLS10GE..... | 12 | WCV7..... | 131, 300 | WTV20..... | 300 |
| TBABLA5..... | 320 | TRSH24..... | 397 | UPLS10M0..... | 12 | WCVL..... | 300 | WVAF..... | 191 |
| TBABLA6..... | 320 | TRV875..... | 59 | UPR6GE..... | 13 | WCVS..... | 300 | WVAF10..... | 191 |
| TBABLA7..... | 320 | TRV053..... | 59 | UPR6M0..... | 13 | WCW69..... | 101 | WVAL..... | 191 |
| TBABLA8..... | 320 | TRV085..... | 59 | UPR9GE..... | 13 | WCW81..... | 101 | WVAML..... | 191 |
| TF122410..... | 416 | TRVR5..... | 59 | UPR9M0..... | 13 | WFB3..... | 201 | WVAP10..... | 191 |
| TF122415..... | 416 | TRVR8..... | 182 | UPR11GE..... | 13 | WFB6..... | 201 | WVASA10..... | 191 |
| TF122420..... | 416 | TRVR10..... | 182 | UPR11M0..... | 13 | WFB9..... | 201 | WVASP..... | 191 |
| TG8..... | 196, 353 | TRVR675..... | 59 | UPS6GE..... | 12 | WFB12..... | 201 | WVASP6..... | 191 |
| TGP8..... | 196, 353 | TRVS6..... | 59 | UPS6M0..... | 12 | WIB80..... | 93 | WVASP10..... | 191 |
| TGS6..... | 196, 352 | TSC7..... | 147, 430 | UPS9GE..... | 12 | WIB100..... | 93 | WVASS..... | 191 |
| TGS8..... | 196, 352 | TSCB2..... | 142 | UPS9M0..... | 12 | WIB120..... | 93 | WVASS10..... | 191 |
| TGS9..... | 196, 352 | TSF7..... | 147, 430 | UPS11GE..... | 12 | WICS34..... | 365 | WVAT1..... | 191 |
| TGS12..... | 196, 352 | TSFP10..... | 393 | UPS11M0..... | 12 | WIR3..... | 101 | WVAT2..... | 191 |
| THMB1..... | 53 | TSH1..... | 51 | USCR2GE..... | 13, 141 | WIR4..... | 101 | WVAT6..... | 191 |
| THMB3..... | 53 | TSH3..... | 51 | USCR2M0..... | 13, 141 | WISS8..... | 93 | | |
| THMB5..... | 53 | TSH5..... | 51 | USCS2GE..... | 12, 141 | WISS10..... | 93 | | |
| THMT1..... | 53 | TTDB2..... | 87 | USCS2M0..... | 12, 141 | WISS12..... | 93 | | |

A

| | |
|-----------------------------------|--|
| ACACIA WOOD..... | 53, 104, 119, 151, 186, 240-241, 257, 355, 368, 285, 426, 437, 446 |
| ALTERNATIVE DRINKING VESSELS..... | 342 |
| ANODIZED PANS..... | 393, 403-417, 422 |
| ANTIQUE COPPER..... | 128, 338, 350, 372 |
| ASH WOOD..... | 248-249 |
| AU GRATIN SERVICE..... | 161 |

B

| | |
|----------------------------|---|
| BAGS..... | 76-77, 85, 450-452 |
| BALTI DISHES..... | 56 |
| BAMBOO..... | 131, 142, 156, 241, 244-247, 298-299, 317, 322-323, 343 |
| BAR BOARDS..... | 359 |
| BAR MATS..... | 375 |
| BAR SPOONS..... | 357-358 |
| BAR STRAINERS..... | 359 |
| BAR TOOLS..... | 354-359 |
| BAR TRAYS..... | 361 |
| BARRIER SYSTEMS..... | 326-330 |
| BASKETS..... | 81, 86-103, 109, 126, 243, 301, 389 |
| BASTING COVERS..... | 398 |
| BEAKERS..... | 346 |
| BENTO BOXES..... | 46-48 |
| BEVERAGE TUBS..... | 302-305, 367-369 |
| BILL/CHECK PRESENTERS..... | 323 |
| BISCUIT CUTTERS..... | 393 |
| BITTERS BOTTLES..... | 345 |
| BOTTLE OPENERS..... | 359, 374 |
| BOTTLE STOPPERS..... | 110, 347, 374 |
| BOWLS..... | 12-15, 17, 22-25, 28-29, 33, 35, 38-39, 42-43, 45-48, 60-61, 78, 82-83, 119, 138, 140, 199-202, 206-213, 216, 218, 220-227, 229-231, 233-234, 238, 241, 247, 260-261, 264, 267-269, 282, 369, 392 |
| BRUSHES..... | 390-391, 453 |
| BUBBLE POPPERS..... | 439 |
| BUFFETWARE..... | 190-197 |
| BURGER MOLD..... | 390 |
| BUTTER WARMER..... | 161 |

C

| | |
|----------------------|--|
| CADDIES..... | 104-109, 128-131, 150-151, 299-301, 372-373, 426, 429, 433 |
| CAKE PANS/RINGS..... | 393-394 |

| | |
|----------------------------------|---------------------------------------|
| CAKE STANDS & COVERS..... | 160, 223, 250-251 |
| CALL BELL..... | 396 |
| CAR PANS..... | 405 |
| CARAFES..... | 110-112, 347-348 |
| CARD SIGNS, CARDS & HOLDERS..... | 306-319 |
| CAST IRON..... | 58-59, 182-183 |
| CEDAR PLANKS..... | 390 |
| CHAFERS..... | 168-174 |
| CHALK MARKERS..... | 321 |
| CHALK MARKER STENCILS..... | 320 |
| CHALKBOARD CARDS..... | 319 |
| CHAMPAGNE SERVICE..... | 363-365 |
| CHECK SPINDLES..... | 396 |
| CHEESE GRATERS..... | 383, 436 |
| CHEESE KNIVES..... | 197 |
| CHEESE PAPER..... | 77 |
| CHEMISTRY COLLECTION..... | 346 |
| CHINA CAP STRAINERS..... | 383 |
| COCKTAIL SHAKERS..... | 350-351 |
| COCKTAIL SMOKING DOME..... | 349 |
| COFFEE CADDIES..... | 128-129, 372-373 |
| COFFEE URNS..... | 169, 171, 189 |
| COFFEE/TEA SERVICE..... | 117-130 |
| COLD CELL..... | 177 |
| CONDIMENT HOLDERS..... | 371 |
| CONDIMENT RACKS..... | 104-109, 287 |
| CORKSCREWS..... | 360 |
| CRATES..... | 125, 131, 174, 255, 256, 297, 299-301 |
| CTP PANS..... | 407 |
| CULINARY BASKETS..... | 389 |
| CUTTERS, BISCUIT & DOUGHNUT..... | 393 |

D

| | |
|-----------------------------------|--------------------|
| DEEP DISH PANS..... | 408-414, 416-417 |
| DEEP SELF-STACKING PANS..... | 414 |
| DELIVERY BAGS..... | 450-452 |
| DETROIT-STYLE PANS..... | 417 |
| DINNERWARE..... | 10-48 |
| DISHERS..... | 380 |
| DOCKERS..... | 424-425 |
| DOMES..... | 160, 223, 251, 349 |
| DOUBLE-WALL DRINKING VESSELS..... | 339-341 |
| DOUGH CUTTERS & SCRAPERS..... | 385, 423 |
| DOUGHNUT CUTTER..... | 393 |

| | |
|-----------------|---------------|
| DREDGE..... | 383 |
| DRINKWARE..... | 332-335 |
| DRIP TRAYS..... | 169, 189, 275 |

E

| | |
|-------------------------|-----|
| EGG RINGS & SLICER..... | 391 |
| ENAMELWARE..... | 78 |

F

| | |
|------------------------------|----------------------------------|
| FLAME GUARDS..... | 180 |
| FLIGHT BOARDS..... | 244, 343 |
| FOLDING BEVERAGE FRAMES..... | 174 |
| FRENCH FRY SCOOPS..... | 384 |
| FRY CUPS..... | 68-75 |
| FRY PANS..... | 55, 58, 60-61, 132, 182-183, 378 |
| FRY PAPER..... | 76 |
| FUNNELS..... | 376, 396 |

G

| | |
|------------------|---|
| GALVANIZED..... | 74, 78, 80, 109, 125, 302, 369, 418 |
| GLASS..... | 65-67, 110, 119, 146-152, 158, 207, 289, 342, 345-347, 351, 427-430 |
| GLASS RACKS..... | 376 |
| GRAVY BOATS..... | 144 |
| GRIDDLES..... | 58, 175, 178-181, 183 |

I

| | |
|----------------------|-----|
| ICE BUCKETS..... | 370 |
| ICE CREAM SPADE..... | 380 |
| ICE MOLDS..... | 349 |

J

| | |
|--|--------------|
| JIGGERS..... | 352 |
| JUICE DISPENSERS, BASES & ACCESSORIES..... | 169, 184-189 |

K

| | |
|-------------|-------------------|
| KNIVES..... | 59, 193, 197, 358 |
|-------------|-------------------|

L

| | |
|------------------------|-----|
| LADLES..... | 379 |
| LEMON LIME PEELER..... | 359 |

LEMON LIME SQUEEZER..... 359
 LOBSTER/NUT CRACKERS 160
 LONG PANS..... 417

M

MALT CUP 351
 MARKERS 321
 MARKET TRAYS..... 176-177, 219
 MEASURING CUPS & SPOONS..... 382-383
 MEGA SCREENS, DISKS & PANS 403
 MENU HOLDERS..... 161, 322-323
 MINI COOKWARE..... 54-55
 MINT JULEP CUPS..... 73, 342
 MIXING BOWLS 392
 MIXING GLASSES 345-351
 MOROCCAN TUMBLER/BOWLS.... 82, 261, 340, 342
 MOSCOW MULE MUG 336-338
 MUDDLERS..... 354-355
 MUGS..... 12, 17, 23, 25, 32, 78, 336-338

N

NAPKIN HOLDERS..... 262, 287
 NOODLE BOWLS..... 23, 229
 NUMBER TENTS 308, 426

O

OIL & VINEGAR CRUETS 158
 OLIVE WOOD 197, 237, 252-256, 317, 446

P

PAELLA PANS 179, 181
 PAILS & TUBS..... 74-75, 80, 302-305, 365-369
 PAN GRIPPERS 425
 PANS 78-79, 263, 267, 393-395, 405-418
 PAPER 74, 76-77, 431
 PAPER TOWEL HOLDERS..... 159
 PARTY TUBS 369
 PEEL RACK 443
 PEELS..... 441-446, 448-449
 PEPPER MILLS 156-157
 PERFORATED DISKS..... 403-404
 PIE PANS..... 79, 395
 PIE ROLLERS..... 423

PITCHERS 113-117
 PIZZA CUTTERS..... 437
 PIZZA CUTTING MATS 439
 PIZZA DELIVERY BAGS 450-452
 PIZZA KNIVES & ROCKERS 438
 PIZZA PANS & TRAYS 402-419
 PIZZA RACKS 440
 PIZZA SCREENS..... 402-403
 PIZZA SERVERS..... 387, 436, 437
 PIZZA STANDS..... 432-435
 PIZZA STONES..... 420-421
 PLASTIC DRINKWARE 332-336
 PLATE COVERS 163-166
 PLATES 12-13, 15, 17, 19, 22, 25, 29, 32, 35, 39, 43, 45, 46-48, 140, 203-204, 214, 223, 250, 289, 419
 PLATTERS 12-13, 17, 22, 25, 32, 35, 39, 45, 46, 57, 63, 199, 203, 206-208, 213-218, 220, 225, 228, 230-234, 242, 246, 251, 257, 285
 POPLAR WOOD..... 84, 130
 PUNCH BOWLS 369

R

RAMEKINS 99, 132-143, 161
 RISERS..... 97, 236, 239, 251, 276-298
 ROLLING PINS 423

S

SALT & PEPPER SHAKERS..... 147-148, 151-157
 SANDWICH BOARDS 320, 324
 SAUCE CUPS..... 12-13, 23, 25, 33, 81, 132-143, 200-202
 SCOOPS..... 358, 384
 SCRAPERS..... 385, 423
 SEAFOOD TRAYS/STANDS..... 270-277
 SEPARATORS..... 415-417
 SERVING BOARDS & PEELS..... 236-241, 244-245, 248-259, 446-449
 SERVING BOWLS & LIDS..... 46-47, 226-227
 SHAKERS 146-155, 427-430
 SICILIAN-STYLE PANS..... 417
 SKIMMERS 389
 SMOKER POLES 325
 SOUP CANS..... 72, 105, 431
 SPOONERS 381
 SPOONS..... 190-195, 357-358, 381

SPREADER..... 190-192, 197, 396
 SPRINGFORM PAN 393
 SQUARE DEEP DISH PANS..... 416-417
 SQUEEZERS 359
 STAINLESS STEEL DRINKING VESSELS ... 336-342
 STANDS 59, 160, 162, 175, 178-181, 204, 225, 275-298, 364-365, 432-435
 STEAK WEIGHTS..... 390
 STORAGE CRATE..... 173
 STRAIGHT-SIDED PANS..... 394, 411-414, 416
 STRAINER FUNNELS 376
 STRAINERS..... 359, 376, 383, 389
 STRAW DISPENSER..... 159
 SYRUP DISPENSER 150

T

TABLETOP BOARDS 320
 TACO HOLDERS 51-53
 TAPERED NESTING PANS 408-411, 417
 TICKET RACKS..... 397
 TONGS..... 127, 190-196, 352, 353, 370, 388
 TRAYS..... 12-13, 15, 46, 48, 78, 122-124, 203, 217, 242, 246, 262-266, 270-276, 305, 361, 367, 418-419
 TRAY STANDS..... 162
 TRIVETS..... 59, 182
 TUBS..... 74-75, 80, 302-305, 365-369
 TURNERS..... 195, 386-387, 436

V

VASES..... 122-123, 145

W

WALL BOARDS 324
 WATER BOTTLES..... 110-112, 347-348
 WHIPS..... 379
 WINE BUCKET & STANDS 333, 363-365
 WINE COOLERS..... 361-364



3708 River Road, Suite 800
Franklin Park, IL 60131

Phone 708-345-1177
Fax 708-345-5758
Toll Free 800-333-9133
Toll Free Fax 800-333-6046
Email info@amnow.com
www.amnow.com

© 2024 American Metalcraft, Inc.



TO VIEW THE LATEST AND
GREATEST PRODUCTS,
SCAN THE CODE BELOW:

