



 **Browne**
FOODSERVICE

Resource Guide
Guía de Recursos

 **equipohotel**
PROVEEDORES DE HOTELES Y RESTAURANTES



*Partners in Success
since 1949*

*Socios en el éxito
desde 1949*

DESIGN THAT ATTRACTS FUNCTION THAT REWARDS QUALITY THAT ENDURES

Throughout the years our product selection has changed, but one thing that has always stayed true is our commitment to innovation in design, quality and value. Our team of in-house designers and sourcing experts manage the creation, procurement and manufacturing of our professional foodservice solutions. We are driven to provide exceptional service that exceeds our customers' expectations and proud of our consistent, fair and genuine approach with all our employees and business partners.

DISEÑO QUE ATRAE FUNCIÓN QUE RECOMPENSA CALIDAD QUE DURA MÁS

A lo largo de los años, nuestra selección de productos ha cambiado, pero una cosa que siempre se ha mantenido fiel es nuestro compromiso con la innovación en diseño, calidad y valor. Nuestro equipo de diseñadores internos y expertos en aprovisionamiento gestionan la creación, adquisición y fabricación de nuestras soluciones profesionales de servicio de alimentos. Estamos motivados a proporcionar un servicio excepcional que supere las expectativas de nuestros clientes y orgullosos de nuestro enfoque coherente, justo y genuino con todos nuestros empleados y socios comerciales.

Our story

With 70 over years of excellence in the foodservice industry, we are proud to be the choice of chefs and foodservice professionals. As part of our commitment to customer service we are driven to maintain a 95%+ consistent fill rate, ensuring you get what you need, when you need it. Browne's dedicated team of foodservice professionals from customer service, account management design and marketing are always available to support your sales team and training needs. Your partner in success since 1949, here are a few snapshots from our foodservice history!



O. Browne & Company & O. Browne Distributing Company registered. Acting as a general trading company, the company was successful in distributing a wide range of products including tires, camping & kitchenware.

O. Browne & Company y O. Browne Distributing Company se registraron. Actuando como una empresa comercial general, la compañía tuvo éxito en la distribución de una amplia gama de productos, incluidos neumáticos, utensilios para acampar y utensilios de cocina.

1988



2nd generation cousins took over the family business, renaming it Browne & Co., with two divisions that focused on creating & sourcing quality products for the foodservice & consumer markets.

Los primos de la segunda generación se hicieron cargo de la empresa familiar y le cambiaron el nombre a Browne & Co. Crearon dos divisiones que se centraron en la creación y el suministro de productos de calidad para los mercados de servicios de alimentos y consumidores.



1995

Thermalloy® Professional Cookware y became the choice of professional chefs for its durability, performance & value.

Los utensilios de cocina profesionales Thermalloy® creados por el Equipo de diseño de Browne, rápidamente se convirtieron en la elección de los chefs profesionales por su durabilidad, rendimiento y valor.



2017

Cuisipro flagship online store was launched with Tmall a leading cross-border e-commerce platform.

La tienda en línea insignia Cuisipro se lanzó con Tmall, una de las principales plataformas de comercio electrónico transfronterizo.



Dennis Poon, seasoned kitchenware industry professional, takes the helm of Browne & Co. With the added-value of vertical integration & supply chain optimization, Browne offers a unique competitive advantage & enhanced global strategic vision.

Dennis Poon, profesional experimentado de la industria de los utensilios de cocina, toma el mando de Browne & Co. Con el valor agregado de la integración vertical y la optimización de la cadena de suministro, Browne ofrece una ventaja competitiva única y una visión estratégica global mejorada.



2019

Celebrated our 70 years anniversary
Celebramos nuestro 70 aniversario

Nuestra Historia

Con 70 años de excelencia en la industria de servicio de alimentos, estamos orgullosos de ser la elección de los chefs y profesionales de servicios de alimentos. Como parte de nuestro compromiso con el servicio al cliente, nos esforzamos por mantener una tasa de cumplimiento constante del 95%, garantizando que obtenga lo que necesita, cuando lo necesite. El equipo dedicado de profesionales del servicio de alimentos de Browne, desde atención al cliente, administración de cuentas y mercadotecnia, está siempre disponible para apoyar a su equipo de ventas y sus necesidades de capacitación. Su compañero para el éxito desde 1949, a continuación hay algunas instantáneas de nuestra historia de servicio de alimentos.



1998

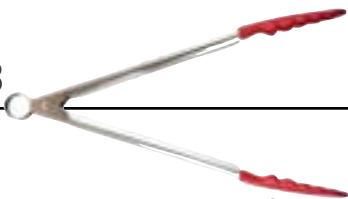

Cuisipro launched with the mission of designing innovative, quality products that bring joy, pleasure and inspiration to the consumer market.

Cuisipro se lanzó con la misión de diseñar productos innovadores y de calidad que brinden alegría, placer e inspiración para el mercado de consumo.

2004

Harold Leonard Company (HALCO) acquired and renamed Browne-Halco, beginning further expansion into the US market.

Harold Leonard Company (HALCO) fue adquirida y pasó a llamarse Browne-Halco y comenzó una mayor expansión en el mercado estadounidense.



2005

Berard, fine quality wood products made in France since 1892, added to the Browne & Co. family. Browne Europe established.

Berard, productos de madera de alta calidad fabricados en Francia desde 1892, se sumó a la familia Browne & Co. Browne se estableció en Europa.

2013

IHA Innovation Award
ESI President Club
*Premio IHA Innovation
ESI President Club*



2012



reddot design award
honorable mention 2012

2006



Revolutionary brand Duncan Kitchen Grips added to company's portfolio and distribution expanded in both foodservice & retail markets.

La revolucionaria marca Duncan Kitchen Grips se agregó a la cartera de la compañía y la distribución se expandió tanto en el mercado de servicios de alimentos como en los mercados minoristas.



Looking ahead Mirando hacia el futuro

We will continue our mission to provide the very best in design, functionality, quality & value.

Nuestro enfoque sigue siendo la excelencia en el servicio de alimentos y bienes de consumo, a la vez que ofrecemos lo mejor en diseño, funcionalidad, calidad y valor.

HOW TO READ THE GUIDE

CÓMO LEER LA GUÍA

Product Description
Descripción del producto

Item Number
Indica número de ítem

Product Name
Nombre del producto

Salt & Pepper Shakers
Paneled Glass. Stainless steel mus room-shaped top with universal holes.

Saleros y pimenteros
Vidrio panelado. Parte superior en forma de hongo de acero inoxidable con perforaciones universales.

ITEM #	CAP	DIM
571912	1 oz / 29 ml	3 x 1.6" 7.6 x 4.1 cm
571930	2 oz / 59 ml	3.6 x 2" 9.2 cm x 5.1 cm
571934	3 oz / 89 ml	4.6 x 2.1" 11.7 x 5.4 cm

Flatware Item Number
Número de ítem para cubiertos:
Example | Ejemplo
LUNA Teaspoon:
5032
+
Last Two Digits of **Teaspoon**
Últimos dos dígitos de cucharilla
23
=
503223

	18/10	18/10	18/10	18/10	18/10	18/10	18/0	18/0	18/0	18/0	18/0	18/0	18/0	18/0	18/0	18/0
Luna							Bistro	Lafayette	Oxford	Contour	Celine	Paris	Elegance	Royal	WIN2	Windsor
	50	50	50	50	50	50	50	50	50	50	50	50	50	50	50	50
	32	39	21	36	30	24	23	22	20	29	25	19	27	26	38	28
	●	●	●	●	●	●	●	●	●	●	●	●	●	●	●	●

SPOONS

TEASPOON		23
----------	---	-----------

SYMBOLS AND LOGOS | SÍMBOLOS Y LOGOTIPOS



NSF

This symbol indicates that a product has been tested by one of the most respected independent certification organizations in existence today. It is valued by consumers, manufacturers, retailers and regulatory agencies worldwide.

Este símbolo indica que un producto ha sido probado por una de las organizaciones de certificación independientes más respetadas que existen en la actualidad. Es valorado por consumidores, fabricantes, minoristas y agencias reguladoras de todo el mundo.



CASH & CARRY

This symbol indicates that a product is supplied with one of these attractive showroom display packaging:

- Colored Box
- Blister Pack
- Hang Card
- Poly Bag with Header Card
- Shrink Wrapped
- Sleeve



CÓMPRALO Y LLÉVATELO

Este símbolo indica que el producto se suministra con un determinado tipo de una variedad de empaques que brindan una presentación atractiva.

- Caja de color
- Empaque en blíster
- Tarjeta para colgar
- Bolsa de polietileno con tarjeta de en la parte superior
- Empaque termocontraíble
- Funda



COLOR-CODED ICONS

Color-coded icons indicate suggested use by color.



GREEN | VERDE
Fruits & Vegetable
Frutas y Vegetable



BLUE | AZUL
Cooked Meat
Vianda Cult



ORANGE | NARANGA
Fish
Pascado



YELLOW | AMARILLA
Poultry
Aves de corral



WHITE | BLANCO
Dairy
Lácteo



RED | ROJO
Meat
Carne



PURPLE | PÚRPURA
Allergen Free
Libre de alérgenos



GAS
GAZ
GAS



ELECTRIC
ÉLECTRIQUE
ELÉCTRICA



CERAMIC
CÉRAMIQUE
CERÁMICA



HALOGEN
HALOGÈNE
HALÓGENA



INDUCTION
INDUCTION
INDUCCIÓN



OVEN
FOUR
HORNO



GRILL
GRIL
PARRILLA

HEAT SURFACES

Product is suitable for use on the indicated heat surfaces.

SUPERFICIES CALIENTES

El producto es adecuado para su uso en las superficies calientes indicadas.

Table of Contents

Indice

PG 12

PROFESSIONAL COOKWARE BATERIA DE COCINA

Tri-Ply

Stainless Steel | *Acero Inoxidable*

2-Ply

Aluminum | *Aluminio*

Cast Iron | *Hierro Fundido*

Carbon Steel | *Acero al Carbono*

Combi Oven | *Horno Comi*

Elements



PG 44

BUFFET / CATERING SERVICE SERVICIO DE BUFÉ / CATERING

Chafers | *Calentador*

Eclipse Serving Tools | *Utensilios de servir*

Eclipse

Parts | *Partes*



**NEW
NUEVO**
Foundation
BROWNE

PG 63

TABLE TOP
SERVICIO DE MESA

NEW! Dinnerware | **NUEVO!** Vajilla
Flatware | *Cubiertos*
Knife Program | *Programa de Cuchillos*
Wood Serving Boards | *Bandeja de Madera*
Single Serves | *Servir Aperitivos*
Table Service | *Servicio de Mesa*
Cash & Carry | *Programa Cash & Carry*
Tray Stand | *Soporte plegable para bandeja*
High Chair | *Sillas altas de Madera*

PG 102

BAR SERVICE
SERVICIO DE BAR

Shaker Cups | *Cocteleras*
Accessories | *Accesorios*
Corkscrews | *Sacacorchos*
Pourers | *Tapón Vertedor*
Jiggers | *Medidores*
Mats | *Esterilla para el bar*



PG 110

KITCHEN SERVICE /
SERVICIO DE COCINA

Steam Pans, Bun Pans | *Fácil de separar,*
Plaques a pâtisserie
Color-Coded Collections | *Colección de*
Codificados por color
Serving Spoons | *Cucharas de Servir*
Bakeware | *Utensilios para hornear*
Pizza / *Innova Tools / Kitchen Grips*



PG 183

CLEAN UP / *LIMPIEZA*

BROWNE QUALITY ASSURANCE

WARRANTIES

LIMITED LIFETIME WARRANTY

Browne warrants **Thermalloy**® Stainless Steel to be free of defect in material, manufacturing and workmanship for the life of the product with the following exceptions:

- Coated pieces - 90 day warranty. Product must be used normally, and care instructions followed. Products that have been abused or misused will not be covered by the limited lifetime warranty
- Minor variations in materials and color are normal

COATED PANS

Browne offers a 90 day warranty on all coated pans and fry pans. This includes all coated products in both the **Thermalloy**® and Elements brands. Warranty is void where products have been abused or misused. Minor variations in materials and color are normal. Browne shall not be liable for loss of use of the product, incidental or consequent costs, expenses or damage however incurred by the purchaser.

FOUNDATION PORCELAIN DINNERWARE

5-Year Limited. No-Chip Warranty. Browne offers a 5 year limited no-chip warranty on the Foundation collection from the date of delivery. Conditions apply.

CUISIPRO

Cuisipro products are designed to deliver high quality, exceptional function and creative design. Cuisipro items offer a limited lifetime warranty against manufacturer's defects from the date of purchase. This warranty will be void if the product fails due to misuse or noncompliance of the general use and care.

NATURAL WOOD PRODUCTS

Browne does not offer a warranty on natural wood product. In order to prolong the life of natural wood products, follow the instructions in our Care and Handling section.

ONE YEAR WARRANTY

Browne warrants, for a period of one year, to repair or replace any product it distributes (except as listed above) in which material, manufacturing or workmanship is deemed to be defective when the item has been used normally and care instructions have been followed.

CARE & HANDLING

COOKWARE

- Prior to first use remove all stickers and labels, then wash in soap and hot water
- Do not leave cookware on heating element without food or liquid
- Always allow cookware to cool before washing
- Direct application of salt to cookware can cause pitting. Add salt after ingredients are placed in the cookware
- Acidic products such as tomatoes and saline solutions can be corrosive and should not be stored in cookware
- Do not soak cookware with disinfectants or chlorine solutions for long periods of time and always follow the instructions of chemical manufacturers
- Life of cookware will be prolonged if ware is washed by hand in soap and hot water. Good appearance will be prolonged by always scrubbing in the direction of the grain of the metal
- After washing, ware should be well rinsed and left to drip dry

NON-STICK COATINGS

- Cookware with non-stick coatings are best washed in soap and hot water once cooled down from use, and then dried immediately
- To preserve life of coating place soft liner between pans when stacking
- Do not use metal utensils

SEASONING STAINLESS STEEL AND ALUMINUM COOKWARE

- For best results Stainless Steel and Aluminum cookware should be seasoned before first use
- After cleaning and drying, coat the cookware lightly with vegetable oil or a small amount of shortening
- Place on medium heat burner for 10-15 minutes until light smoke appears
- When oil turns a deep brown turn off heat and allow pan to cool
- Wipe off excess oil with a paper towel

CARBON STEEL COOKWARE

- **Thermalloy®** Carbon Steel cookware is pre-seasoned and ready for first use after rinsing in hot water only
- To re-season follow Stainless Steel and Aluminum instructions

CAST IRON COOKWARE

- **Thermalloy®** Cast Iron cookware is pre-seasoned and ready for first use after rinsing in hot water only
- To re-season follow Stainless Steel and Aluminum instructions

WOOD SERVING BOARD

OIL FINISH

To clean simply wipe over the surface with a damp cloth or wash in warm soapy water, do not soak. Recommended to regularly oil to keep from drying out. Do not clean in the dishwasher. Handwash recommended.

VARNISH FINISH ACACIA WOOD

To clean simply wipe over the surface with a damp cloth or wash in warm soapy water, do not soak. Do not clean in the dishwasher. Handwash recommended.

MAPLE WOOD BOARD

Wash with a wet soapy cloth each time you are done using your cutting board. Wipe any excess with a dry cloth, dry immediately. Leaving your board on the counter wet may cause it to warp.

- To disinfect, use lemon juice or a mixture of equal parts of water and white vinegar - lightly spray on board or apply with wet cloth. Wipe any excess with a cloth and dry immediately
- Apply 3 - 4 tablespoons of mineral or vegetable oil before first use and repeat approximately every four weeks
- Never submerge board in water
- Never wash board under running water
- Never use dishwasher
- Never leave board close to a heat source

STAINLESS STEEL FLATWARE*

While stainless steel is highly resistant to stain and corrosion, even the finest alloys will suffer if corrosive food acids are not removed by proper soaking, washing, rinsing and drying procedures. Careful handling will prolong the life and luster of your stainless steel tableware.

1. **RINSE** to remove all food remnants immediately after use. Foods which contains salts and acids can slowly break down the finest alloys of the steel.
2. **PRESOAK** in a plastic or stainless steel pan using a nonabrasive presoak compound. (Never use an Aluminum pan). Maximum time is 20 minutes.
3. **WASH** in hot water with a non-abrasive, non corrosive cleaning agent, according to manufacturer's recommendations.
4. **PLACE** in up-right racks, this will allow the water pebbles to flow off the wares. Flat racks can cause damage. The chemicals from the dishwasher will dry on the wares, leading to staining, pitting and perhaps rusting.
5. **RINSE** in water of at least 180°F / 82°C. A wetting agent of water softener may be required if using water with high mineral content.
6. **DRY** immediately. Give rack a shake to remove extra water droplets. This will reduce potential water marks on flatware. Never store the flatware when wet or damp.

**WARNING: Low Temperature Dish washing. If you are using a low-temp or chlorine bath-type dish washing system, take great care in following manufacturer's instructions. An over concentration of sodium hypochlorite (bleach), the active sanitizing agent of these systems, will attack most metal tableware. Improper use, or faulty equipment functioning, will cause staining or corrosion of even the finest stainless steel. Because of the porosity of newly manufactured flatware, we would recommend using a stainless cleanser for the first 6-12 months. The more the flatware is used, the stronger it will be and therefore, resulting in a greater guard against staining and pitting. This is why it is called "stainless" not "stain proof".*



GARANTÍA DE LA CALIDAD DE BROWNE

GARANTÍAS

GARANTÍA LIMITADA DE POR VIDA

Browne garantiza que el acero inoxidable **Thermalloy**® no presentará defectos de material, fabricación ni mano de obra durante la vida útil del producto, con las siguientes excepciones:

- Piezas revestidas: garantía de 90 días. El producto debe usarse normalmente y se deben seguir las instrucciones de cuidado. Los productos que han sido maltratados o mal utilizados no estarán cubiertos por la garantía limitada de por vida.
- Las variaciones menores en materiales y color son normales.

SARTENES REVESTIDAS

Browne ofrece una garantía de 90 días en todas las sartenes y sartenes revestidas. Esto incluye todos los productos revestidos de las marcas **Thermalloy**® y Elements. La garantía es nula cuando los productos han sido maltratados o mal utilizados. Las variaciones menores en materiales y color son normales. Browne no será responsable por la pérdida del uso del producto, costos incidentales o consecuentes, gastos o daños incurridos por el comprador.

VAJILLA DE PORCELANA FOUNDATION

Limitado a 5 años. Garantía contra el astillamiento. Browne ofrece una garantía limitada contra el astillamiento de 5 años en la colección Foundation a partir de la fecha de entrega. Las condiciones se aplican.

CUISIPRO

Los productos Cuisipro están diseñados para ofrecer alta calidad, función excepcional y diseño creativo. Los artículos de Cuisipro ofrecen una garantía limitada de por vida contra los defectos del fabricante desde la fecha de compra. Esta garantía será nula si el producto falla debido al mal uso o incumplimiento de las condiciones de uso y cuidado generales.

PRODUCTOS DE MADERA NATURAL

Browne no ofrece una garantía para productos de madera natural. Para prolongar la vida útil de los productos de madera natural, siga las instrucciones en nuestra sección Cuidado y manipulación.

GARANTÍA DE UN AÑO

Browne garantiza, por un período de un año, la reparación o el reemplazo de cualquier producto que distribuya (excepto según lo mencionado anteriormente) en el que el material, la fabricación o la mano de obra se consideran defectuosos cuando el artículo se ha usado normalmente y se han seguido las instrucciones de cuidado.

CUIDADO Y MANEJO

UTENSILIOS DE COCINA

- Antes del primer uso, retire todos los adhesivos y etiquetas, luego lave con agua caliente y jabón.
- No deje los utensilios de cocina en el elemento calefactor sin comida o líquido.
- Siempre deje enfriar los utensilios de cocina antes de lavarlos.
- La aplicación directa de sal a los utensilios de cocina puede causar picaduras. Agregue sal después de colocar los ingredientes en los utensilios de cocina.
- Los productos ácidos como los tomates y las soluciones salinas pueden ser corrosivos y no deben almacenarse en utensilios de cocina.
- No sumerja los utensilios de cocina con desinfectantes o soluciones de cloro durante largos períodos de tiempo y siga siempre las instrucciones de los fabricantes de productos químicos.
- La vida útil de los utensilios de cocina se prolongará si la vajilla se lava a mano con agua caliente y jabón. El buen aspecto se prolongará fregando siempre en la dirección del grano del metal.
- Después del lavado, la vajilla debe enjuagarse bien y dejarse secar por goteo.

REVESTIMIENTOS ANTIADHERENTES

- Los utensilios de cocina con revestimientos antiadherentes se lavan mejor con jabón y agua caliente una vez que se enfrían con el uso, y luego se secan inmediatamente.
- Para preservar la vida útil del revestimiento, coloque un forro suave entre las bandejas cuando los apile.
- No use utensilios de metal.

SAZONADO DE UTENSILIOS DE COCINA DE ACERO INOXIDABLE Y ALUMINIO

- Para obtener mejores resultados, los utensilios de cocina de acero inoxidable y aluminio se deben sazonar antes del primer uso.
- Después de limpiar y secar, cubra ligeramente los utensilios con aceite vegetal o una pequeña cantidad de manteca.
- Colóquelos en un quemador a fuego medio durante 10-15 minutos hasta que aparezca un ligero humo.
- Cuando el aceite se vuelva marrón oscuro, apague el fuego y deje que la sartén se enfríe.
- Limpie el exceso de aceite con una toalla de papel.

UTENSILIOS DE COCINA DE ACERO AL CARBONO

- Los utensilios de cocina de acero al carbono **Thermalloy®** están pre-sazonados y listos para el primer uso después de enjuagarlos solo con agua caliente.
- Para volver a sazonarlos, siga las instrucciones para acero inoxidable y aluminio.

UTENSILIOS DE COCINA DE HIERRO FUNDIDO

- Los utensilios de cocina de hierro fundido **Thermalloy®** están pre-sazonados y listos para usar por primera vez después de enjuagar solo con agua caliente.
- Para volver a sazonarlos, siga las instrucciones para acero inoxidable y aluminio.

TABLAS DE SERVICIO DE MADERA

MADERA DE ACACIA CON ACABADO DE ACEITE

Para limpiar, simplemente limpie la superficie con un paño húmedo o lave con agua jabonosa tibia, no remoje. Se recomienda engrasar regularmente para evitar que se seque. No limpiar en lavavajillas. Se recomienda el lavado a mano.

MADERA DE ACACIA CON ACABADO DE BARNIZ

Para limpiar, simplemente limpie la superficie con un paño húmedo o lave con agua jabonosa tibia, no remoje. No limpiar en lavavajillas. Se recomienda el lavado a mano.

TABLA DE MADERA DE ARCE

Lávese con un paño húmedo y jabón cada vez que termine de usar su tabla de cortar. Limpie cualquier exceso con un paño seco, seque inmediatamente. Dejar su tabla en el mostrador mojada puede hacer que se deforme.

- Para desinfectar, use jugo de limón o una mezcla de partes iguales de agua y vinagre blanco, rocíe la solución ligeramente sobre la tabla o aplique con un paño húmedo. Limpie cualquier exceso con un paño y seque inmediatamente.
- Aplique 3-4 cucharadas de aceite mineral o vegetal antes del primer uso y repita aproximadamente cada cuatro semanas.
- Nunca sumerja la tabla en agua.
- Nunca lave la tabla con agua corriente.
- Nunca use lavavajillas.
- Nunca deje la tabla cerca de una fuente de calor.

CUBIERTOS DE ACERO INOXIDABLE *

Si bien el acero inoxidable es altamente resistente a las manchas y la corrosión, incluso las mejores aleaciones sufrirán si los ácidos alimentarios corrosivos no se eliminan mediante procedimientos adecuados de remojo, lavado, enjuague y secado. Un manejo cuidadoso prolongará la vida y el brillo de su vajilla de acero inoxidable.

1. **ENJUAGUE** para eliminar todos los restos de comida inmediatamente después de su uso. Los alimentos que contienen sales y ácidos que pueden descomponer lentamente las mejores aleaciones de acero.
2. **PRERREMOJE** en una sartén de plástico o acero inoxidable con un compuesto de prerremojo no abrasivo. (Nunca use una sartén de aluminio). El tiempo máximo es de 20 minutos.
3. **LAVE** en agua caliente con un agente de limpieza no abrasivo ni corrosivo, de acuerdo con las recomendaciones del fabricante.
4. **COLOQUE** en los estantes de arriba a la derecha, esto permitirá que los gotones de agua fluyan fuera de los utensilios. Los racks planos pueden causar daños. Los productos químicos del lavavajillas se secarán en los utensilios, lo que provocará manchas, picaduras e incluso oxidación.
5. **ENJUAGUE** en agua al menos a 180 °F/82 °C. Se podría requerir un agente humectante ablandador de agua si se usa agua con alto contenido mineral.
6. **SEQUE** de inmediato. Agite el rack para eliminar las gotas de agua adicionales. Esto reducirá las posibles marcas de agua en los cubiertos. Nunca guarde los cubiertos cuando estén mojados o húmedos.

**ADVERTENCIA: Lavado de platos a baja temperatura. Si está utilizando un sistema lavavajillas de estilo baño de cloro o de baja temperatura, tenga mucho cuidado en seguir las instrucciones del fabricante. Una concentración excesiva del hipoclorito de sodio (blanqueador), el agente desinfectante activo de estos sistemas, atacará la mayoría de los utensilios*

de metal. El uso incorrecto o el funcionamiento defectuoso del equipo provocarán manchas o corrosión incluso en el mejor acero inoxidable. Debido a la porosidad de los cubiertos recién fabricados, recomendamos

usar un limpiador inoxidable durante los primeros 6-12 meses. Cuanto más se usen los cubiertos, más fuerte serán y por lo tanto, resulta en una mayor protección contra manchas y picaduras. Por eso se denomina «inoxidable» no «a prueba de manchas».

Professional Cookware

Designed to perform and built to last, Browne's extensive Thermalloy® cookware collection is engineered to respond to the demanding needs of commercial kitchens. Designed by Browne's in-house industrial design team Thermalloy® offers industry best design, durability and performance. The extensive Thermalloy® collection features a range of materials including Stainless Steel, Aluminum, Carbon Steel and Cast Iron.

Batería de cocina

Diseñados para un alto rendimiento y fabricados para durar, la extensa colección de batería de cocina Thermalloy® de Browne está diseñada para responder a las exigentes necesidades de las cocinas comerciales. Diseñada por el equipo interno de diseño industrial de Browne, Thermalloy® ofrece el mejor diseño, durabilidad y rendimiento de la industria. La extensa colección Thermalloy® presenta una gama de materiales que incluyen acero inoxidable, aluminio, acero al carbono y hierro fundido.



SEAL OF APPROVAL American Culinary Federation



Unlike other culinary product assurance programs, ACF's Seal of Approval program tests for more than just taste. ACF's Seal represents quality in an entire product, including application and ease of use, physical properties and performance. The Browne Thermalloy® Stainless Steel line has been identified with the ACF Seal of Approval. ACF customized a foodservice panel of culinary experts to test our products in a professional environment to learn our products true professional capabilities through standard criteria. The following are general testing criteria:

- Application: ease of use, versatility of product, adaptability of product
- Physical properties: consistent appearance, texture, color, shape and size
- Performance: use of or applying the product to cooking, baking or service procedure
- Packaging standards: container, label, general compliance with government regulations and standards

Earning the prestigious ACF Seal of Approval from America's most respected chef organization underscores the quality of the Thermalloy® line, and the value of utilizing these kitchen tools for your organization; thus reinforcing Browne's continuing commitment to delivering long-term value to its customers with high quality, high-performance products.

COATINGS

Excalibur® Non-Stick Coating



Excalibur® coating is impregnated with stainless steel for wear resistance and has the release properties of the best non-stick. Designed for premium stainless steel cookware.

Eclipse® Non/Stick Coating



3-layer internally-reinforced non-stick system. Top layer provides the non-stick function while a midcoat bonds the top layer to the bottom layer. This system delivers superior food release characteristics as well as high durability.

SELLO DE APROBACIÓN Federación Culinaria Americana



A diferencia de otros programas de aseguramiento de productos culinarios, el programa Sello de aprobación de la ACF prueba más que solo el sabor. El sello de la ACF representa la calidad de todo un producto, incluida la aplicación y la facilidad de uso, las propiedades físicas y el rendimiento. La línea de acero inoxidable Browne Thermalloy® ha sido identificada con el sello de aprobación de la ACF. La ACF personalizó un panel de expertos en gastronomía para evaluar nuestros productos en un entorno profesional y así conocer las verdaderas capacidades profesionales de nuestros productos a través de criterios estándar. Los siguientes son los criterios generales de prueba:

- Aplicación: facilidad de uso, versatilidad del producto, adaptabilidad del producto
- Propiedades físicas: apariencia, textura, color, forma y tamaño consistentes
- Rendimiento: uso o aplicación del producto en el procedimiento de cocción, horneado o servicio.
- Estándares de embalaje: contenedor, etiqueta, cumplimiento general de las normas y estándares gubernamentales

Obtener el prestigioso Sello de Aprobación de la ACF, la organización de chefs más respetada de los Estados Unidos, subraya la calidad de la línea Thermalloy® y el valor de utilizar estos utensilios de cocina para su organización; lo que refuerza el compromiso continuo de Browne de ofrecer valor a largo plazo a sus clientes con productos de alta calidad y alto rendimiento.

Revestimiento antiadherente Excalibur®



Excalibur® está impregnado con acero inoxidable para brindar resistencia al desgaste y tiene las propiedades de liberación del mejor antiadherente. Diseñado para utensilios de cocina de acero inoxidable premium.

Revestimiento antiadherente Eclipse®



Sistema antiadherente reforzado internamente de 3 capas. La capa superior proporciona la función antiadherente mientras que una capa intermedia une la capa superior a la capa inferior. Este sistema ofrece características superiores de liberación de alimentos, así como una gran durabilidad.

THERMALLOY® STAINLESS STEEL COOKWARE OVERVIEW

DESCRIPCIÓN GENERAL DE LOS UTENSILIOS DE COCINA DE ACERO INOXIDABLE THERMALLOY®

	ITEM#	DES	ACF	NSF	FINISH ACABADO	DIM	CAP	2-PLY	TRI-PLY	COVER CUBIERTA
FRY PANS SARTENES PARA FREIR	573770	8" Standard Estándar	•	•	Natural	20 cm				
	573771	9.5" Standard Estándar	•	•	Natural	24 cm				
	573772	11" Standard Estándar	•	•	Natural	28 cm				
	573773	12.5" Standard Estándar	•	•	Natural	32 cm				
	573775	8" Standard Estándar	•	•	Excalibur	20 cm				
	573776	9.5" Standard Estándar	•	•	Excalibur	24 cm				
	573777	11" Standard Estándar	•	•	Excalibur	28 cm				
	573778	12.5" Standard Estándar	•	•	Excalibur	32 cm				
	5724092	8" Tri-Ply	•	•	Natural	20 cm			•	
	5724093	9.5" Tri-Ply	•	•	Natural	24 cm			•	
	5724094	11" Tri-Ply	•	•	Natural	28 cm			•	
	5724096	8" Tri-Ply	•	•	Excalibur	20 cm			•	
	5724097	9.5" Tri-Ply	•	•	Excalibur	24 cm			•	
	5724098	11" Tri-Ply	•	•	Excalibur	28 cm			•	
	5724044	Mini Tri-Ply	•		Natural		0.3 L		•	
	5724048	7.8" Deluxe	•	•	Natural	19.8 cm				5724120
	5724050	9.5" Deluxe	•	•	Natural	24 cm				5724124
	5724051	11" Deluxe	•	•	Natural	28 cm				5724128
	5724052	12.5" Deluxe (with Handle con mango)	•	•	Natural	32 cm				5724132
	5724054	14" Deluxe (with Handle con mango)	•	•	Natural	35.5 cm				5724136
	5724058	7.8" Deluxe	•	•	Excalibur	19.8 cm				5724120
	5724060	9.5" Deluxe	•	•	Excalibur	24 cm				5724124
	5724061	11" Deluxe	•	•	Excalibur	28 cm				5724128
	5724062	12.5" Deluxe (with Handle con mango)	•	•	Excalibur	30.5 cm				5724132
	5724064	14" Deluxe (with Handle con mango)	•	•	Excalibur	35.5 cm				5724136
	5812807	7" 2-Ply		•	Natural	18 cm			•	
	5812808	8" 2-Ply		•	Natural	20 cm			•	
	5812810	10" 2-Ply		•	Natural	25.4 cm			•	
	5812812	12" 2-Ply		•	Natural	30.5 cm			•	
	5812827	7" 2-Ply		•	Excalibur	18 cm			•	
	5812828	8" 2-Ply		•	Excalibur	20 cm			•	
	5812830	10" 2-Ply		•	Excalibur	25.4 cm			•	
	5812832	12" 2-Ply		•	Excalibur	30.5 cm			•	
SAUCE PANS CACEROLAS	5724030	Mini Tri-Ply (with Lid con tapa)	•		Natural		0.3 L		•	Included / Includido
	5724032	2 QT Deep Sauce Pan Cacerola profunda	•	•	Natural	16 cm	2 L			5724116
	5724033	3.5 QT Deep Sauce Pan Cacerola profunda	•	•	Natural	19.8 cm	3.5 L			5724120
	5724034	4.5 QT Deep Sauce Pan Cacerola profunda	•	•	Natural	19.8 cm	4.5 L			5724120
	5724036	6 QT Deep Sauce Pan Cacerola profunda	•	•	Natural	21.6 cm	6 L			5724122
	5724037	7.6 QT Deep (with Handle con mango)	•	•	Natural	24 cm	7.6 L			5724124
	5724040	10 QT Deep (with Handle con mango)	•	•	Natural	28 cm	10 L			5724128
	5724161	6" Low Baja	•	•	Natural	16 cm	1.5 L			5724116
	5724162	8" Low Baja	•	•	Natural	20 cm	2.5 L			5724120
	5724164	9.5" Low Baja	•	•	Natural	24 cm	5 L			5724124
5724166	11" Low (with Handle con mango)	•	•	Natural	28 cm	8 L			5724128	

	ITEM*	DES	ACF	NSF	FINISH ACABADO	DIM	CAP	2-PLY	TRI-PLY	COVER CUBIERTA
WOKS	5724095	12" Tri-Ply Wok	•	•	Natural	30.5 cm			•	
	5724100	14" Tri-Ply Wok	•	•	Natural	36 cm			•	
	5724102	12" Tri-Ply Wok	•	•	Excalibur	31 cm			•	
	5724104	14" Tri-Ply Wok	•	•	Excalibur	36 cm			•	
PAELLA PAN PAELLERA	5724171	9.5" Paella Pan Paellera	•	•		24 cm				5724124
	5724172	11" Paella Pan Paellera	•	•		28 cm				5724128
	5724173	12.5" Paella Pan Paellera	•	•		32 cm				5724132
	5724174	16" Paella Pan Paellera	•	•		41 cm				
SAUTÉ PANS SARTENES PARA SAUTEAR	5724041	6.3"	•	•		16 cm	1.2 L			5724116
	5724042	8.5"	•	•		21.6 cm	2 L			5724120
	5724180	8"	•	•		20 cm	2 L			5724120
	5724181	9.5" (with Handle con mango)	•	•		24 cm	3 L			5724124
	5724182	11" (with Handle con mango)	•	•		28 cm	4 L			5724128
	5724186	9.5"	•	•		24 cm	7 L			2724124
SAUCE POTS OLLAS	5724188	11"	•	•		28 cm	11 L			5724128
	5724190	12.5"	•	•		32 cm	16 L			5724132
	5724192	14"	•	•		35.5 cm	22 L			5724136
	5724009	8 QT	•	•		28 cm	8 L			5724128
BRAZIERES CALDEROS	5724014	15 QT	•	•		35.5 cm	15 L			5724136
	5724019	20 QT	•	•		40.1 cm	20 L			5724140
	5724024	25 QT	•	•		45.2 cm	25 L			5724145
	5724029	30 QT	•	•		49.5 cm	30 L			5724150
PASTA COOKER OLLA PARA PASTAS	5724082	12 QT (3 Piece set 3 piezas)	•	•		33.8 cm	12 L			Included Incluye
	5724090	20 QT (3 Piece set 3 piezas)	•	•		36.8 cm	20 L			Included Incluye
DOUBLE BOILERS JUEGOS PARA BAÑO MARIA	5724068	8 QT (3 Piece set 3 piezas)	•	•		24 cm	9 L			Included Incluye
	5724072	12 QT (3 Piece set 3 piezas)	•	•		26.15 cm	12 L			Included Incluye
	5724076	16 QT (3 Piece set 3 piezas)	•	•		28 cm	16 L			Included Incluye
	5724080	20 QT (3 Piece set 3 piezas)	•	•		29.9 cm	20 L			Included Incluye
STOCK POTS OLLAS DE SOPA	5723906	15 oz Mini (with Lid con tapa)	•	•			0.44 L		•	Included Incluye
	5723908	8.3 QT	•	•		21.6 cm	8.3 L			5724122
	5723910	9.6 QT	•	•		24 cm	9.6 L			5724124
	5723912	12 QT	•	•		26.2 cm	12 L			5724126
	5723916	16 QT	•	•		28 cm	16 L			5724128
	5723920	20 QT	•	•		32 cm	20 L			5724132
	5723924	24 QT	•	•		33.8 cm	24 L			5724134
	5723932	32 QT	•	•		34.3 cm	32 L			5724134
	5723940	40 QT	•	•		45.2 cm	40 L			5724145
	5723960	60 QT	•	•		49.5 cm	60 L			5724150
	5723980	80 QT	•	•		49.5 cm	80 L			5724150
	5724000	100 QT	•	•		49.5 cm	100 L			5724150
ROAST PANS MOLDES PARA ASAR	5724175	3 QT Rectangular Rectangulares	•	•		28 cm	2.8 L		•	
	5724176	4.6 QT Rectangular Rectangulares	•	•		36 cm	4.35 L		•	
	5724177	2.6 QT Oval Ovaladas	•	•		30.5 cm	2.46 L		•	
	5724179	2QT Deep Profunda	•	•		36 cm	6.6 L		•	5724151



Thermalloy
PROFESSIONAL COOKWARE



TRI PLY

STAINLESS STEEL COOKING
SURFACE FOR SUPERIOR
COOKING PERFORMANCE

- Three layers of metal seamlessly bonded together - bottom layer of stainless steel, aluminum & top layer of stainless steel
- Superior thermal conductivity and even heating. Offset rivets for stronger handle attachment
- Stainless steel outer layer is induction ready and easy to clean



GAS
GAS



ELECTRIC
ELÉCTRICA



CERAMIC
CERÁMICA



HALOGEN
HALÓGENA



INDUCTION
INDUCCIÓN



TRI PLY

SUPERFICIE DE COCCIÓN DE
ACERO INOXIDABLE PARA UN
RENDIMIENTO DE COCCIÓN
SUPERIOR.

- Tres capas de metal unidas a la perfección: capa inferior de acero inoxidable, aluminio y capa superior de acero inoxidable
- Conductividad térmica superior y calentamiento uniforme. Remaches descentrados para un mango más fuerte
- La capa exterior de acero inoxidable está lista para la inducción y es fácil de limpiar



What makes it Tri-Ply? / ¿Qué cosa es Tri-Ply?

* Selected Excalibur non-stick coating as shown
En estilos antiadherentes seleccionados

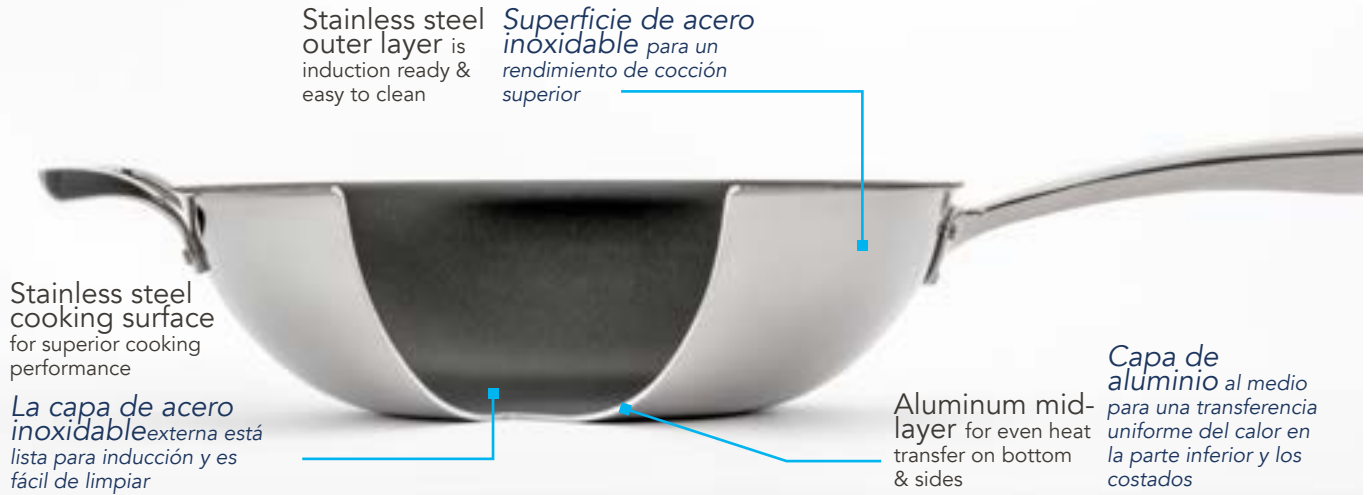

TRI-PLY Fry Pans
Natural Finish.

Sartenes para freír, TRI-PLY
Acabado, natural.

ITEM	DIM
5724092	8 x 1.5" / 20 x 4 cm
5724093	9.5 x 2" / 24 x 5 cm
5724094	11 x 2" / 28 x 5 cm



TRI-PLY Fry Pans
Excalibur Coated. 

Sartenes para freír, TRI-PLY
Acabado antiadherente. 

ITEM #	DIM
5724096	8 x 1.5" / 20 x 4 cm
5724097	9.5 x 2" / 24 x 5 cm
5724098	11 x 2" / 28 x 5 cm



TRI-PLY Woks
Natural Finish.

Woks, TRI-PLY
Acabado, natural.

ITEM #	CAP	DIM
5724095	5 QT / 4.7 L	12 x 3.6" 31 x 9 cm
5724100	9 QT / 8.5 L	14 x 3.5" 35.5 x 9 cm



TRI-PLY Woks
Excalibur Coated. 

Woks, TRI-PLY
Acabado antiadherente. 

ITEM #	CAP	DIM
5724102	5 QT / 4.7 L	12 x 3.6" 31 x 9 cm
5724104	9 QT / 8.5 L	14 x 3.5" 35.5 x 9 cm



TRI-PLY Stainless Steel Roast Pans

Thermalloy® Roast Pans display dishes beautifully, with ornate and yet ergonomic handles. Perfect for cooking and serving. Quite simply the highest quality cook and serveware on the market. Ideal for buffet displays.



GAS
GAS



ELECTRIC
ELÉCTRICA



CERÁMIC
CERÁMICA



HALOGEN
HALÓGENA



INDUCTION
INDUCCIÓN



Bandejas para asar, TRI-PLY

Los moldes para asar Thermalloy® exhiben los platos de forma exquisita con mangos adornados y ergonómicos. Perfectos para cocinar y servir. En pocas palabras, es el utensilio para cocinar y servir de más alta calidad en el mercado. Ideal para exhibiciones de buffet.



TRI-PLY Oval Roast Pan
Bandeja para asar oval

ITEM #	CAP	DIA #
5724177	2.6 QT / 2.46 L	12 x 10.4 x 2" 30.5 x 26.5 x 5 cm



TRI-PLY Rectangular Roast Pan
Bandeja para asar rectangular

ITEM #	CAP	DIM
5724175	3 QT / 2.8 L	11 x 8.7 x 2" 28 x 22 x 5 cm
5724176	4.6 QT / 4.35 L	14 x 11.4 x 2" 36 x 29 x 5 cm



TRI-PLY Deep Roast Pan
Cover available 5724151. Sold separately.

Bandeja profunda para asar
Cubierta disponible 5724151. Se vende por separado.

ITEM #	CAP	DIM
5724179	7 QT / 6.6 L	14 x 10.2 x 3.7" 36 x 29 x 9.5 cm

TRI-PLY Roast Pan Cover
Suitable only for 5724179. Sold separately.

Cubierta para bandeja de asar de tres capas
Solo para 5724179. Se vende por separado.

ITEM #
5724151



STAINLESS STEEL

ERGONOMIC HANDLE DESIGN
REDUCES HAND & WRIST FATIGUE

- "Stay Cool" hollow cast handles, will not get hot during cooking
- ¼" / 6 mm impact bonded aluminum sandwich base provides fast and even heat distribution
- Efficient and consistent heat conductivity on any make or model of induction cooktop
- Offset rivets on fry pan handles for superior attachment



GAS
GAS



ELECTRIC
ELÉCTRICA



CERAMIC
CERÁMICA



HALOGEN
HALÓGENA



INDUCTION
INDUCCIÓN



ACERO INOXIDABLE

EL DISEÑO ERGONÓMICO DEL
MANGO REDUCE LA FATIGA DE
LA MANO Y LA MUÑECA

- Los mangos huecos "Stay Cool" no se calientan durante la cocción
- La base tipo sándwich de aluminio unido por impacto de ¼" / 6 mm brinda una distribución de calor rápida y uniforme
- Conductividad térmica eficiente y consistente en cualquier marca o modelo de estufa de inducción
- Remaches descentrados en los magos de la sartén para una sujeción superior



 Browne





Deluxe Fry Pans

Natural Finish. Offset rivets for superior handle attachment.

Sartenes para freír

Acabado natural. Las asas extra anchas permiten un fácil recojo cuando se usan guantes para horno.

ITEM #	DIM (WXH)
5724048	7.8 x 1.5" / 20 x 4 cm
5724050	9.5 x 2" / 24 x 5 cm
5724051	11 x 2" / 28 x 5 cm

With helper handle | Con mango

5724052	12 x 2" / 30 x 5 cm
5724054	14 x 2.3" / 36 x 6 cm

Non-stick finish | Acabado antiadherente

ITEM #	DIM (WXH)
5724058	7.8 x 1.5" / 20 x 4 cm
5724060	9.5 x 2" / 24 x 5 cm
5724061	11 x 2" / 28 x 5 cm

With helper handle | Con mango

5724062	12.5 x 2" / 32 x 5 cm
5724064	14 x 2.3" / 36 x 6 cm



Standard Fry Pans Sartenes para freír

Natural Finish | Acabado natural

ITEM #	DIM (WXH)
573770	8 x 1.5" / 20 x 4 cm
573771	9.5 x 2" / 24 x 5 cm
573772	11 x 2" / 28 x 5 cm
573773	12.5 x 2" / 32 x 5 cm

Non-stick finish | Acabado antiadherente

ITEM #	DIM (WXH)
573775	8 x 1.5" / 20 x 4 cm
573776	9.5 x 2" / 24 x 5 cm
573777	11 x 2" / 28 x 5 cm
573778	12.5 x 2" / 32 x 5 cm



5724041
5724042



5724180



5724181

Sauté Pans Sartenes para saltar

ITEM #	DES	CAP	DIM (WXH)	COVER† CUBIERTA†
5724041	Tapered Cónicas	1.2 QT / 1.14 L	6.3 x 2.4" / 16 x 6 cm	5724116
5724042	Tapered Cónicas	2 QT / 1.89 L	8.5 x 2.8" / 22 x 7 cm	5724120
5724180	Tapered Cónicas	2 QT / 1.89 L	8 x 2.9" / 20 x 7.4 cm	5724120
With helper handle Con mango				
5724181	Straight-sided Lado recto	3 QT / 2.8 L	9.5 x 3" / 24 x 7.6 cm	5724124
5724182	Straight-sided Lado recto	4 QT / 3.78 L	11 x 2.9" / 28 x 7.4 cm	5724128

Riveted handles for increased durability.

Poignées rivetées pour une meilleure durabilité.

†Covers sold separately unless noted.

†Todas las cubiertas se venden por separado a menos que se indique lo contrario.



5724161

Low Sauce Pan Cacerolas de poca profundidad para salsas

ITEM #	CAP	DIM (WXH)	COVER† CUBIERTA†
5724161	1.5 QT / 1.4 L	6 x 3.2" 6 x 8.2 cm	5724116
5724162	2.5 QT / 2.36 L	8 x 3.5" 20 x 9 cm	5724120
5724164	5 QT / 4.73 L	9.5 x 4.6" 24 x 11.8 cm	5724124



5724166

With helper handle Con mango			
5724166	8 QT / 7.57 L	11 x 5.5" 28 x 14 cm	5724128



5724032

Deep Sauce Pan Cacerolas profundas para guisar

ITEM #	CAP	DIM (WXH)	COVER† CUBIERTA†
5724032	2 QT / 1.89 L	6.3 x 3.8" 16 x 9.5 cm	5724116
5724033	3.5 QT / 3.31 L	7.8 x 4" 20 x 10.5 cm	5724120
5724034	4.5 QT / 4.25 L	7.8 x 5.5" 20 x 14 cm	5724120
5724036	6 QT / 5.678 L	8.5 x 6" 22 x 15.5 cm	5724122



5724037

With helper handle Con mango			
5724037	7.6 QT / 7.19 L	9.5 x 6.3" 24 x 16 cm	5724124
5724040	10 QT / 9.46 L	11 x 6.3" 28 x 16 cm	5724128



Sauce Pot Ollas de acero inoxidable para salsas

ITEM #	CAP	DIM (WXH)	COVER† CUBIERTA†
5724186	7 QT / 6.62 L	9.5 x 6.3" 24 x 16 cm	5724124
5724188	11 QT / 10.4 L	11 x 7" 28 x 18 cm	5724128
5724190	16 QT / 15.14 L	12.5 x 7.9" 32 x 20 cm	5724132
5724192	22 QT / 20.8 L	14 x 8.7" 36 x 22 cm	5724136



Thermalloy
PROFESSIONAL COOKWARE

Stainless Steel

American Culinary Federation Seal of Approval - the only Commercial Stainless cookware to pass ACF's rigorous testing criteria and earn the ACF Seal of Approval

Sello de aprobación de la Federación Culinaria Estadounidense: los únicos utensilios de cocina comerciales de acero inoxidable cumplen con los rigurosos criterios de prueba de ACF y obtienen el Sello de aprobación de ACF



Paella Pans Poêles à paella

ITEM #	CAP	DIM (WXH)
5724171	2 QT / 1.89 L	9.5 x 2" 24 x 5 cm
5724172	3 QT / 2.83 L	11 x 2" 28 x 5 cm
5724173	3.7 QT / 3.5 L	12.5 x 2" 31.7 x 5 cm
5724174	8.6 QT / 8 L	16 x 2" 40.6 x 5 cm



Braziers Braisières

ITEM #	CAP	DIM (WXH)	COVER† COUVERCLE†
5724009	8 QT / 7.57 L	11 x 5" 28 x 13 cm	5724128
5724014	15 QT / 14.19 L	14 x 5.5" 36 x 14 cm	5724136
5724019	20 QT / 18.9 L	15.8 x 5.8" 40 x 15 cm	5724140
5724024	25 QT / 23.65 L	17.8 x 5.8" 45 x 15 cm	5724145
5724029	30 QT / 28.4 L	19.5 x 5.8" 50 x 15 cm	5724150

Stainless Steel Inset Panier en acier inoxydable

DIM (LXWXH) 11.5 x 8.375 x 7" / 29 x 21 x 17.7 cm

ITEM #	CAP	HOLES DIA DIAMÈTRE DES TROUS	FITS
5724013	3 QT / 2.83 L	0.45 cm	5724014

NEW
NUEVO

†Covers sold separately unless noted.

†Covers sold separately unless noted.

† Todas las cubiertas se venden por separado a menos que se indique lo contrario.

† Les couvercles sont vendus séparément, à moins d'avis contraire.



Double Boiler 3 Piece Set

Includes solid insert and cover. Insert not sold separately.

Bains-marie, ensemble de 3 pièces

Comprend un récipient encastrable et un couvercle.
Le récipient encastrable n'est pas vendu séparément.

ITEM #	CAP	OVERALL DIM (WXH)	INSERT (WXH)	POT (WXH)	INSERT CAP
5724068	9 QT 8.5 L	9.5 x 9.63" 24 x 24.46 cm	9.5 x 6.81" 24 x 17.3 cm	9.5 x 7.81" 24 x 19.84 cm	4 QT 3.78 L
5724072	12 QT 11.35 L	10.25 x 11.5" 26.04 x 29.21 cm	10.25 x 8.5" 26.04 x 21.6 cm	10.25 x 9.56" 26.04 x 24.28 cm	7 QT 6.75 L
5724076	16 QT 15.14 L	11 x 12.81" 28 x 32.54 cm	11 x 9.88" 28 x 25.1 cm	11 x 10.75" 28 x 27.31 cm	10 QT 9.5 L
5724080	20 QT 18.9 L	11.88 x 13.75" 30.18 x 34.93 cm	11.88 x 10.75" 30.18 x 27.31 cm	11.88 x 11.75" 30.18 x 29.85 cm	13 QT 12.5 L



Pasta Cooker 3 Piece Set

Includes perforated insert and cover.
Insert not sold separately.

Bouilloires à pâtes, ensembles de 3 pièces

Vendues avec un panier perforé et un couvercle.
Le panier perforé n'est pas vendu séparément.

ITEM #	CAP	OVERALL DIM (WXH)	INSERT (WXH)	POT (WXH)
5724082	12 QT 11.35 L	10.25 x 11.81" 26.04 x 30 cm	10.25 x 8.88" 26.04 x 22.56 cm	10.25 x 9.63" 26.04 x 24.46 cm
5724090	20 QT 18.9 L	11.75 x 13.13" 29.85 x 33.35 cm	11.75 x 10.88" 29.85 x 27.64 cm	11.75 x 11.81" 29.85 x 30 cm



Deep Stock Pots Marmites profondes

ITEM #	CAP	DIM (WXH)	COVER† COUVERCLE†
5723908	8 QT / 8.3 L	8.2 x 8" / 22 x 24 cm	5724122
5723910	9.6 QT / 9 L	9.5 x 7.8" / 24 x 20 cm	5724124
5723912	12 QT / 11.35 L	10.3 x 8.8" / 26 x 22.5 cm	5724126
5723916	16 QT / 15.14 L	11 x 9.8" / 28 x 25 cm	5724128
5723920	20 QT / 18.9 L	12.5 x 10.3" / 32 x 26 cm	5724132
5723924**	24 QT / 22.7 L	13.3 x 10.3" / 34 x 26 cm	5724134
5723932**	32 QT / 30.2 L	13.3 x 13.3" / 34 x 34 cm	5724134
5723940**	40 QT / 37.85 L	17.8 x 11" / 45 x 28 cm	5724145
5723960**	60 QT / 56.78 L	19.5 x 12.5" / 50 x 32 cm	5724150
5723980**	80 QT / 75.7 L	19.5 x 15.8" / 50 x 40 cm	5724150
5724000**	100 QT / 94.63 L	19.5 x 19.5" / 50 x 50 cm	5724150

†Covers sold separately unless noted.

**Non Cash & Carry
†Covers sold separately unless noted.
†Todas las cubiertas se venden por separado a menos que se indique lo contrario.

†Les couvercles sont vendus séparément, à moins qu'il n'y ait une note contraire.
**Non Cash & Carry



Thermalloy
PROFESSIONAL COOKWARE



2-PLY

STAINLESS STEEL INTERIOR WITH ALUMINUM EXTERIOR, OFFERS THE BEST PROPERTIES OF BOTH METALS IN THIS 2-LAYER DESIGN.

- Stainless steel layer corrosion resistant for durability, aluminum exterior for superior heat distribution
- Non-drip edge
- Ergonomic heat resistant silicone sleeves included



GAS
GAS



ELECTRIC
ELÉCTRICA



CERAMIC
CERÁMICA



HALOGEN
HALÓGENA



2-PLY

EL INTERIOR DE ACERO INOXIDABLE CON EXTERIOR DE ALUMINIO OFRECE LAS MEJORES PROPIEDADES DE AMBOS METALES EN ESTE DISEÑO DE 2 CAPAS.

- Capa de acero inoxidable resistente a la corrosión para una mayor durabilidad, exterior de aluminio para una distribución de calor superior
- Borde antigoteo
- Todas las sartenes incluyen fundas de silicona resistentes al calor





2-PLY Fry Pans
Sleeve included.

Sartén para freír
Funda incluida.

ITEM #	DIM (WXH)
5812807	7" / 18 cm
5812808	8" / 20 cm
5812810	10" / 25.4 cm
5812812	12" / 30.5 cm



Silicone Sleeve for 2-Ply Fry Pan
Over-molded silicone handle, cavity is completely sealed against water and debris. Heat resistant: 572°F / 300°C.

Funda desprendible de silicona, para el mango de la Sartén para freír 2-Ply
El mango de silicona es resistente al calor hasta 572°F / 300°C.

ITEM #	FOR PARA	SARTÉN PARA FREIR
5811135	7" / 18 cm & 8" / 20 cm	
5811136	10" / 25.4 cm & 12" / 30.5 cm	



2-PLY Fry Pans
Excalibur Coated. Sleeve included.

Sartén para freír
Acabado antiadherente. Funda incluida.

ITEM #	DIM (WXH)
5812827	7" / 18 cm
5812828	8" / 20 cm
5812830	10" / 25.4 cm
5812832	12" / 30.5 cm

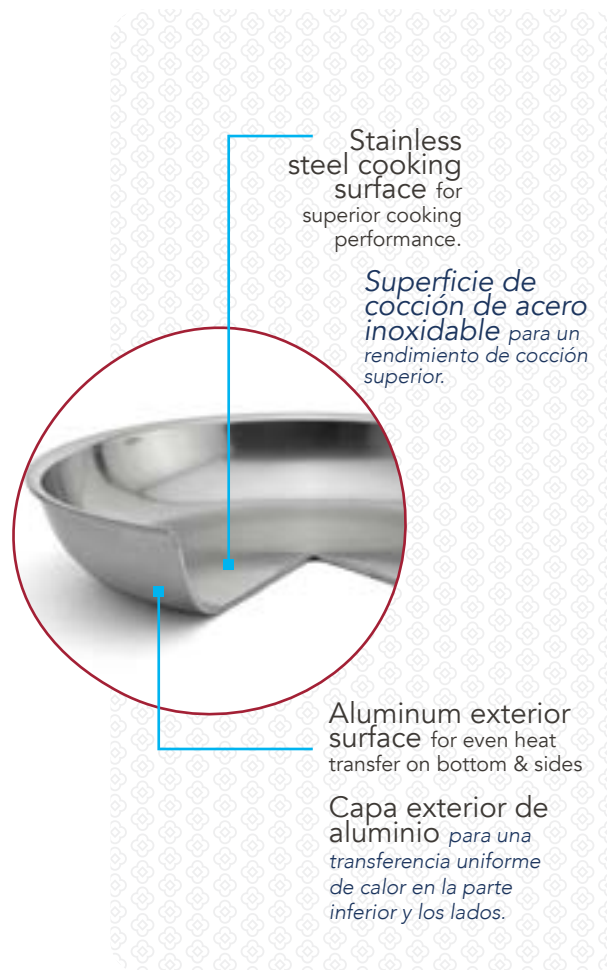

Stainless steel cooking surface for superior cooking performance.

Superficie de cocción de acero inoxidable para un rendimiento de cocción superior.

Aluminum exterior surface for even heat transfer on bottom & sides

Capa exterior de aluminio para una transferencia uniforme de calor en la parte inferior y los lados.



ALUMINUM

WIDE BASE ON FRY PANS ALLOWS FOR LARGER SURFACE & ENSURE PAN SITS FLAT ON HEAT SOURCE

- Durable aluminum construction for even heat distribution
- All handles securely fastened with rivets for extra durability
- Lustrous satin finish
- Choice of standard (4mm/6 GA) and heavy weight (6mm/2GA) options
- Pots include extra wide handle that can be used with oven gloves



GAS
GAS



ELECTRIC
ELÉCTRICA



CERAMIC
CERÁMICA



HALOGEN
HALÓGENA



ALUMINIO

LA BASE ANCHA PERMITE UNA SUPERFICIE MÁS GRANDE Y ASEGURA QUE LA SARTÉN SE ASIENTE SOBRE LA FUENTE DE CALOR

- Construcción de aluminio duradera para una distribución uniforme del calor
- Todos los mangos están bien sujetos con remaches para una mayor durabilidad
- Acabado satinado brillante
- Opciones estándar (4 mm/6 GA) y pesada (6 mm/2GA)
- Las ollas incluyen un asa extra ancha que se puede usar con guantes para horno





Heavy Weight Fry Pans

4.5 mm / 5 Gauge. Sleeve included. Wide base allows for larger cooking surface and ensures pan sits flat on heat source. Offset rivets in handles for superior attachment that will not loosen over time. Comfort angled handle design enables easy pick-up without touching hot surface. Heat resistant (572°F/300°C) removable silicone sleeve included, ergonomic design reduces hand fatigue.

Sartenes para freír para servicio de alto volumen

4.5 mm / calibre 5. Incluye funda. La base ancha permite una superficie de cocción más grande y asegura que la sartén se apoye sobre la fuente de calor. Remaches descentrados en las asas para una sujeción superior que no se aflojarán con el tiempo. El diseño cómodo del mango en ángulo permite un fácil recojo sin tocar la superficie caliente. Incluye funda de silicona extraíble resistente al calor (572 °F / 300 °C), diseño ergonómico que reduce la fatiga de las manos.

Natural Finish | Acabado natural.

ITEM #	DIM (WXH)
5814807	7 x 1.3" / 18 x 3.2 cm
5814808	8 x 1.5" / 20 x 3.8 cm
5814810	10 x 2" / 25.4 x 5 cm
5814812	12 x 2.3" / 30.5 x 5.7 cm
5814814	14 x 2.5" / 35.6 x 6.3 cm

Non-Stick Finish, 3 layer non-stick coating, formulated for optimal results on aluminum cookware. Acabado antiadherente Recubrimiento antiadherente de 3 capas, formulado para obtener resultados óptimos en utensilios de cocina de aluminio.

ITEM #	DIM (WXH)
5814827	7 x 1.3" / 18 x 3.2 cm
5814828	8 x 1.5" / 20 x 3.8 cm
5814830	10 x 2" / 25.4 x 5 cm
5814832	12 x 2.3" / 30.5 x 5.7 cm
5814834	14 x 2.5" / 35.6 x 6.3 cm



Heavy Weight Straight-Sided Sauce Pans
6.0 mm / 2 Gauge.

Cacerolas para guisar, extra pesadas con lados rectos
6.0 mm / 2 Calibre.

ITEM #	CAP	DIM (WXH)	SLEEVE	COVER† CUBIERTA†
5814502	2.5 QT / 2.36 L	7.3 x 3.8" 18.5 x 9.6 cm	5811133	5815502
5814503	3.75 QT / 3.54 L	8 x 4.5" 20.5 x 11.6 cm	5811134	5815503
5814507	7.5 QT / 7.09 L	9.5 x 6.3" 24 x 16.2 cm	5811134	5815507
With helper handle Con mango				
5814511	11 QT / 10.4 L	11 x 6.8" 28 x 17 cm	5811134	5815511



Heavy Weight Braziers
6.0 mm / 2 Gauge.

Calderos para servicio de alto volumen
6.0 mm / 2 Calibre.

ITEM #	CAP	DIM (WXH)	COVER† CUBIERTA†
5814415	15 QT / 14.19 L	13.5 x 5.8" 34.5 x 15 cm	5815415
5814418	18 QT / 17 L	15.4 x 5" 39.2 x 15 cm	5815418
5814424	24 QT / 22 L	17 x 6.3" 43.2 x 16 cm	5815424
5814428	28 QT / 26.5 L	20 x 5.5" 51 x 14 cm	5815428
5814435	35 QT / 33.12 L	21.65 x 6" 55 x 15 cm	5815435

HEAVY WEIGHT  ALTO VOLUMEN

Heavy Weight Sauce Pots
6.0 mm / 2 Gauge

Ollas para guisar para servicio de alto volumen
6.0 mm / 2 Calibre.

ITEM #	CAP	DIM (WXH)	COVER† CUBIERTA†
5814314	14 QT 13.25 L	12 x 7.5" 30 x 19.5 cm	5815314
5814320	20 QT 18.9 L	12.5 x 9" 32 x 23 cm	5815320
5814326	26 QT 24.6 L	13.5 x 10" 35 x 25 cm	5815326
5814334	34 QT 32 L	15.6 x 10" 39.6 x 25.4 cm	5815334



Heavy Weight Stock Pots
6.0 mm / 2 Gauge

Ollas de sopa para servicio de alto volumen
6.0 mm / 2 Calibre.

ITEM #	CAP	DIM (WXH)	COVER† CUBIERTA†
5814108	8 QT 7.57 L	9 x 7.5" 23 x 19 cm	5815008
5814112	12 QT 11.35 L	9.8 x 9.3" 25 x 24 cm	5815012
5814116	16 QT 15.14 L	11 x 9.8" 28 x 25.5 cm	5815016
5814120	20 QT 18.9 L	11.8 x 10.8" 30 x 28 cm	5815020
5814124	24 QT 22.7 L	12.5 x 11.25" 32 x 29 cm	5815024
5814132	32 QT 30.2 L	13.8 x 12.5" 35 x 32 cm	5815032
5814140	40 QT 37.85 L	14.5 x 14.25" 37 x 36.5 cm	5815040

7.0 mm / 1 Gauge | 7,0 mm / 1 Calibre

ITEM #	CAP	DIM (WXH)	COVER† CUBIERTA†
5814160	60 QT 56.78 L	17.3 x 16" 44 x 40.5 cm	5815060
5814180	80 QT 75.7 L	18.8 x 16.7" 48 x 43 cm	5815080
5814200	100 QT 94.63 L	20 x 17.6" 51 x 45 cm	5815100
5814220	120 QT 113.56 L	21.5 x 19.5" 55 x 50 cm	5815120
5814240*	140 QT 132.49 L	23.5 x 19.5" 60 x 50 cm	5815140
5814260*	160 QT 157.42 L	23.5 x 22" 60 x 56 cm	5815140

*4 handle version | Version à 4 poignées



†Covers sold separately unless noted.

†Todas las cubiertas se venden por separado a menos que se indique lo contrario.



Standard Weight Fry Pans

3.5 mm / 8 Gauge. Removable sleeve included. Wide base allows for larger cooking surface and ensures pan sits flat on heat source. Offset rivets in handles for superior attachment that will not loosen over time. Comfort angled handle design enables easy pick-up without touching hot surface. Heat resistant (572°F/300°C) removable silicone sleeve included, ergonomic design reduces hand fatigue.

Sartenes para freír de peso estandar

4.5 mm / calibre 5. Incluye funda. La base ancha permite una superficie de cocción más grande y asegura que la sartén se apoye sobre la fuente de calor. Remaches descentrados en las asas para una sujeción superior que no se aflojarán con el tiempo. El diseño cómodo del mango en ángulo permite un fácil recojo sin tocar la superficie caliente. Incluye funda de silicona extraíble resistente al calor (572 °F / 300 °C), diseño ergonómico que reduce la fatiga de las manos.

Natural Finish | Acabado natural

Non-Stick Finish, 3 layer non-stick coating, formulated for optimal results on aluminum cookware. | Acabado antiadherente Recubrimiento antiadherente de 3 capas, formulado para obtener resultados óptimos en utensilios de cocina de aluminio.



ITEM #	DIM (WXH)	ITEM #	DIM (WXH)
5813807	7 x 1.3" / 18 x 3.2 cm	5813827	7 x 1.3" / 18 x 3.2 cm
5813808	8 x 1.5" / 20 x 3.8 cm	5813828	8 x 1.5" / 20 x 3.8 cm
5813810	10 x 2" / 25.4 x 5 cm	5813830	10 x 2" / 25.4 x 5 cm
5813812	12 x 2.3" / 30.5 x 5.7 cm	5813832	12 x 2.3" / 30.5 x 5.7 cm
5813814	14 x 2.5" / 35.6 x 6.3 cm	5813834	14 x 2.5" / 35.6 x 6.3 cm



Sauté Pans

4.0 mm / 6 gauge

Sartenes para saltear

4.0 mm / 6 Calibre

ITEM #	CAP	DIM (WXH)	SLEEVE MANGA	COVER† CUBIERTA†
5813703	3 QT 2.83 L	9 x 2.5" 25.4 x 6.6 cm	5811133	5815703
5813705	5 QT 4.73 L	11.5 x 2.9" 29.2 x 7.4 cm	5811134	5815705
5813707	7 QT 6.62 L	13.5 x 3" 34.3 x 7.6 cm	5811134	5815707
5813711	11 QT 10.4 L	15.3 x 3" 39 x 9.1 cm	5811134	5815711





Our Award Winning Thermalloy® Professional Cookware has many built in design features to offer outstanding performance, ease of use and added durability.

Nuestra galardonada batería de cocina Thermalloy® tiene muchas características de diseño integradas para ofrecer un rendimiento excepcional, facilidad de uso y mayor durabilidad.

STANDARD WEIGHT  PESO ESTANDAR



Standard Weight Tapered Sauce Pans
4.0 mm / 6 Gauge

Cacerolas de peso estándar, con lados graduados
4.0 mm / 6 Calibre.

ITEM #	CAP	DIM (WXH)	SLEEVE MANGA	COVER† CUBIERTA†
5813901	1.5 QT / 1.4 L	5.8 x 3.8" 14.9 x 9.8 cm	5811133	5815901
5813902	2.5 QT / 2.36 L	7.6 x 4.2" 19.4 x 10.7 cm	5811133	5815902
5813903	3.75 QT / 3.54 L	8.5 x 4.5" 21.6 x 11.8 cm	5811134	5815903
5813904	4.5 QT / 4.2 L	9 x 5" 23 x 12.7 cm	5811134	5815904
5813905	5.5 QT / 5.2 L	9.75 x 5" 24.8 x 12.7 cm	5811134	5815905
5813907	7 QT / 6.62 L	10.5 x 5.7" 26.5 x 14.5 cm	5811134	5815907

With helper handle | Avec deuxième poignée sur le côté opposé

5813908	8.5 QT / 8 L	11.5 x 5.6" 29.2 x 13.6 cm	5811134	5815908
5813911	10.25 QT / 10 L	12.3 x 5.5" 31.5 x 14 cm	5811134	5815911



Standard Weight Braziers
4.0 mm / 6 Gauge

Calderos para servicio de peso estándar
4.0 mm / 6 Calibre.

ITEM #	CAP	DIM (WXH)	COVER† CUBIERTA†
5813415	15 QT / 14.19 L	13.5 x 5.8" 34.5 x 15 cm	5815415
5813418	18 QT / 17 L	15.4 x 5" 39.2 x 15 cm	5815418
5813424	24 QT / 22 L	17 x 6.3" 43.2 x 16 cm	5815424



Standard Weight Sauce Pots
4.0 mm / 6 Gauge

Ollas para guisar para servicio de peso estandar
4.0 mm / 6 Calibre.

ITEM #	CAP	DIM (WXH)	COVER† CUBIERTA†
5813314	14 QT / 13.25 L	12 x 7.5" 30 x 19.5 cm	5815314
5813320	20 QT / 18.9 L	12.5 x 9" 32 x 23 cm	5815320
5813326	26 QT / 24.6 L	13.5 x 10" 35 x 25 cm	5815326
5813334	34 QT / 32 L	15.6 x 10" 39.6 x 25.4 cm	5815334



Standard Weight Stock Pots
Ollas de sopa de peso estándar

4.0 mm / 6 Gauge | 4.0 mm / 6 Calibre

ITEM #	CAP	DIM (WXH)	COVER† CUBIERTA†
5813108	8 QT / 7.57 L	9 x 7.5" / 23 x 19 cm	5815008
5813112	12 QT / 11.35 L	9.8 x 9.3" / 25 x 24 cm	5815012
5813116	16 QT / 15.14 L	11 x 9.8" / 28 x 25.5 cm	5815016
5813120	20 QT / 18.9 L	11.8 x 10.8" / 30 x 28 cm	5815020
5813124	24 QT / 22 L	12.5 x 11.25" / 32 x 29 cm	5815024
5813132	32 QT / 30.2 L	13.8 x 12.5" / 35 x 32 cm	5815032
5813140	40 QT / 37.85 L	14.5 x 14.25" / 37 x 36.5 cm	5815040

5.0 mm / 4 Gauge | 5.0 mm / 4 Calibre

ITEM #	CAP	DIM (WXH)	COVER† CUBIERTA†
5813160	60 QT / 56.78 L	17.3 x 16" / 44 x 40.5 cm	5815060
5813180	80 QT / 75.7 L	18.8 x 16.7" / 48 x 43 cm	5815080
5813200	100 QT / 94.63 L	20.25 x 17.75" / 51.44 x 45.09 cm	5815100



Standard Weight Double Boiler Sets
Cover and insert included.

Juegos para baño maría de peso estándar
Cubierta y canasta incluidas.

ITEM #	CAP	DIM (W x H)	REPLACEMENT COVER CUBIERTA DE REPUESTO	REPLACEMENT INSERTS REPUESTO CANASTAS	INSERT CAP CAP DE CANASTAS
5813208	8 QT 7.57 L	9.3 x 8" 23.5 x 20 cm	5815208	5813208-1	5 L 5 QT
5813212	12 QT 11.35 L	10.3 x 9.3" 26 x 23.5 cm	5815212	5813212-1	7.5 L 8 QT
5813216	16 QT 15.14 L	11.3 x 9.3" 28.5 x 23.5 cm	5815216	5813216-1	10 L 10.5 QT
5813220	20 QT 18.9 L	12 x 9.8" 30.5 x 24.8 cm	5815220	5813220-1	12 L 12.5 QT



Pasta Cooker with Four Insets**
Olla para pasta con 4 canastas**

**Non NSF

ITEM #	CAP	DIM (WXH)
5813318	20 QT / 18.9 L	14.25 x 7" / 36.2 x 17.78 cm Without handles sin asas 16.75 x 7" / 42.55 x 17.78 cm With handles con asas

Stainless Steel Inset
Panier en acier inoxydable

ITEM #	CAP	HOLES DIA DIAMÈTRE DES TROUS
5813319	3 QT / 2.83 L	0.45 cm



Straight Sided Roast Pan

Aluminum. 1.0 mm / 18 Gauge. With plated steel loop handles. Handles fold down for storing and up for ease of use. Straight sided, natural finish. Full perimeter rolled edge.

Molde de aluminio para asar con lados rectos

Molde de aluminio para asar con lados rectos. 1.0 mm (calibre 19) con asas en forma de argolla de acero enchapado. Las asas se bajan para guardarse y se levantan para su uso. Lados derechos, acabado natural. Borde enrollado en todo el perímetro.

ITEM #	DIM (LXWXH)
5811014	18.7 x 12.8 x 2.4" / 47.5 x 32.5 x 6 cm



Aluminum Roast Pan

Aluminum. Natural finish. Riveted loop handles, with rolled edge. Full size. 1.0 mm / 18 Gauge.

Molde para asar

Aluminio. Acabado natural. Asas remachadas en forma de argolla. Con bordes enrollados. 1.0 mm / 18 Calibre.

ITEM #	DIM (LXWXH)
5811015	17 x 11 x 2" / 44 x 29 x 5.5 cm

†Covers sold separately unless noted.

†Todas las cubiertas se venden por separado a menos que se indique lo contrario.



CAST IRON

PRE-SEASONED FOR A NATURAL, EASY RELEASE FINISH THAT IMPROVES WITH USE. PFOA / PTFE FREE.

- Non-stick properties protect delicate foods while cooking
- Straight side walls for larger cooking surface and enhanced display presentation
- Heats evenly for superior browning
- Retains heat well for low temperature cooking and serving
- Complete one piece design for strength and durability

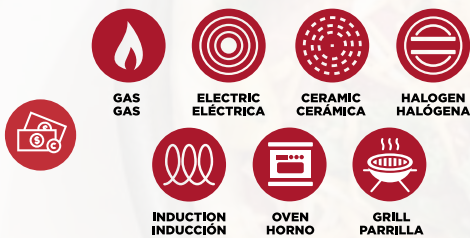

HIERRO FUNDIDO

PRESAZONADA PARA UN ACABADO NATURAL DE FÁCIL LIBERACIÓN QUE MEJORA CON EL USO. LIBRE DE PFOA / PTFE.

- Las propiedades antiadherentes protegen los alimentos delicados durante la cocción
- Paredes laterales rectas para una superficie de cocción más grande y una presentación mejorada
- Calienta uniformemente para un dorado superior
- Conserva bien el calor para cocinar y servir a baja temperatura
- Diseño completo de una pieza para mayor resistencia y durabilidad



Pre-seasoned Skillet, Round
Suitable for use with all utensils.

Sartén pre-sazonada, redondas
Suitable for use with all utensils

ITEM #	CAP	DIM (W x H)
573724	0.25 QT / 236.59 ml	4 x 1" / 10 x 2.54 cm
573726	0.69 QT / 650.62 ml	6 x 1.6" / 15.25 x 4.06 cm
573728	1.38 QT / 1.3 L	8 x 1.6" / 20.3 x 4.06 cm
573730	2.5 QT / 2.37 L	10 x 1.7" / 25.4 x 4.32 cm
573732	3.63 QT / 3.43 L	12 x 1.7" / 30.5 x 4.32 cm

See page 86 for our Compatible Cast Iron Mini Collections

Stylish and practical cast iron minis are ideal for creating unique serving experiences.

Vaya a la página 86 para nuestras Mini Colecciones de Hierro Fundido de cortesía

Las elegantes y prácticas mini colecciones de hierro fundido son ideales para crear experiencias de servicio únicas.



CARBON STEEL

IDEAL FOR UNIQUE SERVING OF APPETIZERS, SIDES OR DESSERTS

- Heats quickly and evenly for superior browning
- Pre-seasoned for a natural, easy-release finish that improves with use - PFOA/PTFE free
- Thick pan body keeps the pan from warping during commercial use
- Fry pans have offset riveted handle, for extra durability

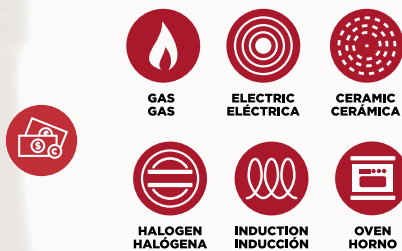

ACERO AL CARBONO

IDEAL PARA UN SERVICIO ÚNICO DE APERITIVOS, ACOMPAÑAMIENTOS O POSTRES.

- Se calienta de forma rápida y uniforme para un dorado superior
- Presazonada para un acabado natural y de fácil liberación que mejora con el uso, libre de PFOA / PTFE
- El cuerpo grueso de la bandeja evita que la bandeja se deforme durante el uso comercial
- Las cacerolas de freír tienen un mango remachado para mayor durabilidad

Carbon Steel Fry Pan, 2-Handle Sartén de acero al carbono, con dos asas

ITEM #	DIM
573745	5.5 x 1.2" / 14 x 3 cm
573746	6.3 x 1.3" / 16 x 3.3 cm
573748	7.8 x 1.75" / 20 x 4.4 cm
573752	11.8 x 2.25" / 30 x 5.7 cm

Carbon Steel Fry Pan Sartén de acero al carbono

ITEM #	DIM
573735	5.5 x 1.25" / 14 x 3 cm
573736	6.3 x 1.3" / 16 x 3.3 cm
573738	7.8 x 1.6" / 20 x 4.1 cm
573740	10.2 x 1.8" / 26 x 4.6 cm

Carbon Steel Fry Pan with Helper Handle Sartén de acero al carbono con mango y asa

ITEM #	DIM
573742	11.8 x 2.25" / 30 x 5.7 cm





COMBI OVEN

A RANGE OF ACCESSORIES
ENGINEERED TO PROVIDE
OPTIMAL PERFORMANCE AND
DURABILITY.

- Wide selection of styles, sizes and finishes for a range of cooking needs
- Full collection offers solutions ideal for a range of cooking styles including grilling, baking, roasting, deep-frying, steaming and re-therm
- Universal fit for all Combi Ovens - 1/1 GN

HORNO COMBI

*EL HORNO MIXTO THERMALLOY
OFRECE UNA SERIE DE
ACCESORIOS DISEÑADOS
PARA UN RENDIMIENTO Y
DURABILIDAD ÓPTIMOS.*

- *Amplia selección de estilos, tamaños y acabados para una diversidad de necesidades de cocción*
- *La colección completa ofrece una idea de soluciones para una variedad de estilos de cocción que incluyen asar, hornear, asar, freír, cocinar al vapor y volver a cocinar*
- *Ajuste universal para todos los hornos combinados - 1/1 GN*

HIGH QUALITY &
PERFORMANCE AT
A COMPETITIVE PRICE
ALTA CALIDAD Y
RENDIMIENTO A **UN**
PRECIO COMPETITIVO

Enameled Roast Pans

Granite enamel finish for exceptional durability and longevity

Sartenes para asar esmaltadas

Acabado de esmalte de granito para ofrecer una durabilidad y longevidad excepcionales

- Sturdy one-piece stamped construction for increased durability and hygiene
- Excellent heat conductivity & even browning
- Fully rounded corners prevent food loss
- *Sólida construcción estampada de una pieza para mayor durabilidad e higiene*
- *Excelente conductividad térmica y dorado uniforme.*
- *Las esquinas completamente redondeadas evitan la pérdida de alimentos*



Enameled Roast Pans

Steel. Granite enamel finish. 20 Gauge. High heat resistance of 662°F / 350°C. Dishwasher safe. Suitable for silicone, nylon and wooden utensils.

Sartenes para asar esmaltadas

Acero. Esmalte de granito. Calibre 20. Adecuada para utensilios de silicona, nylon y madera. Alta resistencia al calor de 662°F / 350°C.

ITEM #	DIM
576201	20.75 x 12.75 x 0.75" / 52.7 x 32.4 x 2 cm
576202	20.75 x 12.75 x 1.5" / 52.7 x 32.4 x 4 cm
576203	20.75 x 12.75 x 2.5" / 52.7 x 32.4 x 6.4 cm



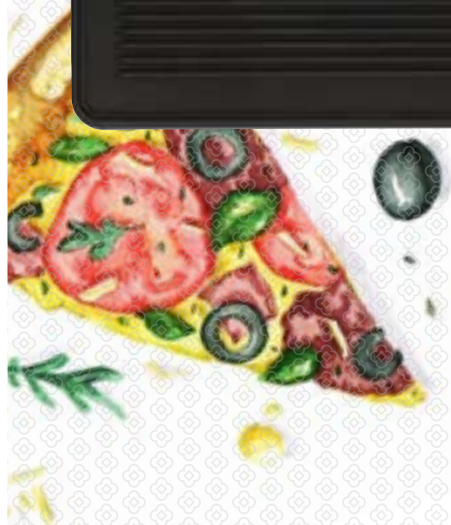

Grill & Pizza Tray

Reversible two-sided design offers maximum functionality and flexibility

Bandeja antiadherente para parrillas y pizzas

La conception réversible à deux côtés offre une fonctionnalité et une flexibilité maximales

- Grill side provides traditional grill marks on meat, poultry, fish and vegetables
- Flat side provides ideal surface for crisping pizzas, breads and tortillas
- Consistent heat conductivity ensuring uniform result.
- 3 layer non-stick PolyFlon coating offers superior release and high durability

Not intended for industrial dishwashers

- *El lado de la parrilla aplica marcas de parrilla tradicionales en carne, aves de corral, pescado y verduras*
- *El lado plano proporciona una superficie ideal para pizzas crujientes, panes y tortillas*
- *Conductividad térmica constante que garantiza resultados uniformes*
- *El recubrimiento PolyFlon antiadherente de 3 capas ofrece una capacidad de liberación superior y alta durabilidad*

No diseñado para lavavajillas industriales



Grill side
El lado de la parrilla

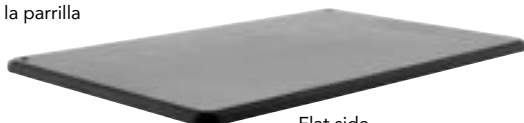

Flat side
El lado de la plano

Non-stick Grill and Pizza Tray

Cast aluminum. PolyFlon non-stick finish. Suitable for silicone, nylon, and wooden utensils. High heat resistance of 575°F / 300°C.

Bandeja antiadherente para parrillas y pizzas

Aluminio moldeado. PolyFlon antiadherente. Adecuado para utensilios de silicona, nylon y madera. Alta resistencia al calor de 575°F / 300°C.

ITEM #	DIM
576206	20.75 x 12.75" / 52.7 x 32.4 cm

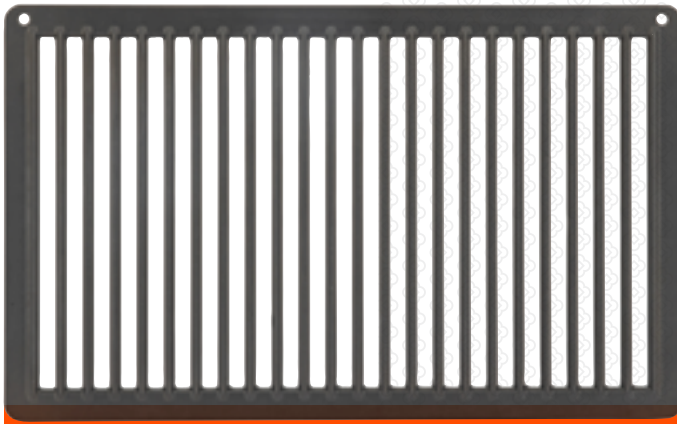

Non-stick Grill Tray

Two-sided open grill design offers increased airflow and optimal searing

Bandeja para parrilla antiadherente

El diseño de parrilla abierta de dos lados ofrece un mayor flujo de aire y una abrasión óptima

Non-stick Grill Tray

Cast aluminum/ PolyFlon non-stick finish. High heat resistance of 575°F / 300°C. Suitable for silicone, nylon, and wooden utensils.

Bandeja para parrilla antiadherente

Aluminio moldeado. PolyFlon antiadherente. Alta resistencia al calor de 575°F / 300°C. Adecuado para utensilios de silicona, nylon y madera.

ITEM # DIM
576207 20.75 x 12.75" / 52.7 x 32.4 cm

- Create traditional grill marks on meat, poultry, fish and vegetables
- Consistent heat conductivity ensuring uniform results
- 3 layer non-stick PolyFlon coating offers superior release and high durability

Allow the pan to cool completely before cleaning. Dry immediately and completely. It is important no water is left to sit on the pan.

- Cree marcas de parrilla tradicionales en carne, aves de corral, pescado y verduras
- Conductividad térmica constante que garantiza resultados uniformes
- El recubrimiento PolyFlon antiadherente de 3 capas ofrece una capacidad de liberación superior y alta durabilidad

Deje que la sartén se enfríe completamente antes de limpiarla. Séquela de inmediato y por completo. Es importante que no quede agua en la sartén.

Baking Tray

Aluminum. 3 layer PolyFlon non-stick coating offers superior release and high durability. 16 Gauge. Suitable for silicone, nylon, and wooden utensils. High heat resistance of 575°F / 300°C.

Bandeja de hornear

Aluminio. PolyFlon antiadherente. El recubrimiento PolyFlon antiadherente de 3 capas ofrece una capacidad de liberación superior y alta durabilidad. Calibre 16 mm. Adecuado para utensilios de silicona, nylon y madera. Alta resistencia al calor de 575°F / 300°C.

ITEM # DIM
576210 20.75 x 12.75" / 52.7 x 32.4 cm

- One-piece stamped construction for increased durability and hygiene
- Excellent heat conductivity ensures even cooking and consistent results

Allow the pan to cool completely before cleaning. Dry immediately and completely. It is important no water is left to sit on the pan.

- Construcción estampada de una pieza para mayor durabilidad e higiene
- La excelente conductividad térmica garantiza una cocción uniforme y resultados conherentes

Deje que la sartén se enfríe completamente antes de limpiarla. Séquela de inmediato y por completo. Es importante que no quede agua en la sartén.



Baking Tray

Corner pour spouts for easy draining of excess juice

Bandeja de hornear

Becs verseurs dans les coins pour vider facilement l'excédent de jus de cuisson

8 Section Baker

Ideal for eggs, omelets, pancakes, rosti or tortillas, and more.

Horno de 8 secciones

Ideal para huevos, tortillas, panqueques, rostisería o tortillas, y más.

- Uniform cooking in each section, ensuring consistent results
- One-piece stamped construction for increased durability and hygiene
- 3 layer non-stick PolyFlon coating offers superior release and high durability

Not intended for industrial dishwashers

- *Cocción uniforme en cada sección, garantizando resultados consistentes*
- *Construcción estampada de una pieza para mayor durabilidad e higiene.*
- *El recubrimiento PolyFlon antiadherente de 3 capas ofrece una capacidad de liberación superior y alta durabilidad*

No diseñado para lavavajillas industriales



8-Section Baker

Aluminum. PolyFlon non-stick finish. 8 sections with 0.5" / 1.2cm depth. 16 Gauge. Suitable for silicone, nylon, and wooden utensils. High heat resistance of 575°F / 300°C .

Horno de 8 secciones

Aluminio. PolyFlon antiadherente. 8 secciones con 0.5" / 1.2 cm de profundidad. Calibre 16. Adecuado para utensilios de silicona, nylon y madera. Alta resistencia al calor de 575°F / 300°C.

ITEM #	DIM
576209	20.75 x 12.75" / 52.7 x 32.4 cm





Crisping / Frying Tray

Alternating raised mound design, increases airflow and circulation for even cooking and optimal browning results

Bandeja para freír

El diseño de montículo elevado alternativo aumenta el flujo de aire y la circulación para lograr una cocción uniforme y resultados óptimos de dorado

- Facilitates healthier cooking, by baking not frying, no additional oil required
- Cook large portions, with consistent results in high volume kitchens
- Ideal for cooking any item that you want a perfect crisp result, including fries, wedges, onion rings, calamari, nuggets/fingers, spring rolls and many more
- *Facilita una cocción más saludable, al hornear no freír, no se requiere aceite adicional*
- *Cocine porciones grandes, con resultados uniformes en cocinas de gran volumen*
- *Ideal para cocinar cualquier comida para la que desee un resultado crujiente perfecto, incluidas papas fritas, gajos, aros de cebolla, calamares, nuggets/dedos de pollo, rollitos de primavera y muchos más*

Crisping / Frying Tray

Welded construction for increased durability and longevity. Small gauge stainless steel wire cooking surface for excellent heat transference. Suitable for use with metal, silicone, nylon and wooden utensils. High heat resistance of 662°F / 350°C. Dishwasher safe.

Bandeja para freír

Construcción soldada para una mayor durabilidad y longevidad. Superficie de cocción de alambre de acero inoxidable de pequeño calibre para una excelente transferencia de calor. Adecuado para utensilios de metal, silicona, nylon y madera. Alta resistencia al calor de 662°F / 350°C. Se puede lavar en lavavajillas.

ITEM # DIM

576204 21 x 13 x 1" / 53.3 x 33 x 2.5 cm

Grid

Electroplated finish to protect welded joints from rust and corrosion

Rejilla

Acabado galvanizado para proteger las uniones soldadas del óxido y la corrosión

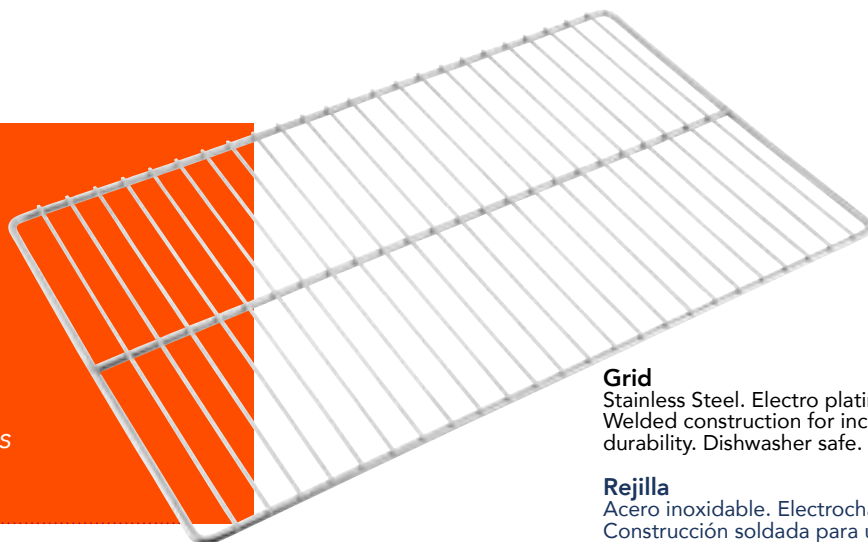

Grid

Stainless Steel. Electro plating finish. Welded construction for increased durability. Dishwasher safe.

Rejilla

Acero inoxidable. Electrochapado. Construcción soldada para una mayor durabilidad. Se puede lavar en lavavajillas.

ITEM # DIM

576211 20.75 x 12.75" / 52.7 x 32.4 cm



COMMERCIAL QUALITY
STAINLESS STEEL COOKWARE FOR
PROFESSIONAL KITCHENS

- 4mm / 0.15" Tri-Ply base allows for even heat distribution
- Hollow, cool-touch handles reduces heat build up
- Dome cover facilitates self-basting when cooking
- Riveted handles on all pieces, including covers, for extra durability and longevity
- Covers included with sauce pots, sauce pans and braziers
- High quality Teflon Select coating* provides long-lasting durability and excellent release properties (*on selected non-stick styles)



GAS
GAS



ELECTRIC
ELÉCTRICA



CERAMIC
CERÁMICA



HALOGEN
HALÓGENA



INDUCTION
INDUCCIÓN



OVEN
HORNO



UTENSILIOS DE COCINA DE CALIDAD
COMERCIAL EN ACERO INOXIDABLE
PARA COCINAS PROFESIONALES

- La base Tri-Ply de 4 mm / 0,15" permite una distribución uniforme del calor
- Los mangos huecos y fríos reducen la acumulación de calor
- La tapa tipo domo facilita el untado al cocinar
- Mangos remachados en todas las piezas, incluidas las tapas, para una mayor durabilidad y longevidad
- Tapas incluidas con las ollas, sartenes y braseros.
- El revestimiento Teflon Select de alta calidad* proporciona una alta durabilidad y excelentes propiedades de liberación (*en estilos antiadherentes seleccionados)





Stainless Steel Fry Pan Sartén para freír

ITEM # DIM (WXH)

Natural Finish. | Acabado natural.

5734048 8 x 1.6" / 20 x 4 cm

5734050 9.5 x 2" / 24 x 5 cm

5734051 11 x 2" / 28 x 5 cm

With helper handle | Con mango

5734052 12.5 x 2" / 32 x 5 cm

5734054 14 x 2.4" / 36 x 6 cm

Teflon Select® Non-Stick Coating
Revestimiento antiadherente Teflon Select®



5734058 8 x 1.6" / 20 x 4 cm

5734060 9.5 x 2" / 24 x 5 cm

5734061 11 x 2" / 28 x 5 cm

5734062 12.5 x 2" / 32 x 5 cm

5734064 14 x 2.4" / 36 x 6 cm

Ergonomic handles
for comfort and
ease of use.

*Remaches
descentrados para
una sujeción
superior
del asa.*



Sauce Pans Includes cover.

Ollas para salsas Incluye tapa.

ITEM #	CAP	DIM (WXH)	REPLACEMENT COVER CUBIERTA DE REPUESTO
5734032	2 QT / 1.89 L	6.3 x 3.9" / 16 x 10 cm	5734116
5734033	3.5 QT / 3.31 L	7.9 x 4.3" / 20 x 11 cm	5734120
With helper handle Con mango			
5734034	4.5 QT / 4.25 L	7.9 x 5.7" / 20 x 14.5 cm	5734120
5734035	5.3 QT / 5 L	9.4 x 4.5" / 24 x 11.5 cm	5734124
5734037	7.6 QT / 7.2 L	9.4 x 6.5" / 24 x 16.5 cm	5734124
5734040	10 QT / 9.5 L	11 x 6.3" / 28 x 16 cm	5734128



Sauté Pans Includes cover.

Sartenes para saltear Incluye tapa.

ITEM #	CAP	DIM (WXH)	REPLACEMENT COVER CUBIERTA DE REPUESTO
5734185	5 QT / 4.75 L	11.8 x 3" / 30 x 7.5 cm	5734130
5734187	7 QT / 6.75 L	13.4 x 3.3" / 34 x 8.5 cm	5734134



Stock Pot
Includes cover.

Ollas de sopa
Incluye tapa.

ITEM #	CAP	DIM (WXH)	REPLACEMENT COVER CUBIERTA DE REPUESTO
5733905	5 QT / 5 L	9.4 x 4.6" / 24 x 11.7 cm	5734124
5733908	8 QT / 7.57 L	9.4 x 6.5" / 24 x 16.5 cm	5734124
5733912	12 QT / 11.25 L	11 x 7.3" / 28 x 18.5 cm	5734128
5733916	16 QT / 15 L	11 x 10" / 28 x 25.5 cm	5734128
5733920	20 QT / 19 L	11.8 x 10.4" / 30 x 26.5 cm	5734130
5733924	24 QT / 22.75 L	13.4 x 10.6" / 34 x 27 cm	5734134
5733932	32 QT / 30.25 L	14.2 x 12.2" / 36 x 31 cm	5734136
5733940	40 QT / 38 L	15.7 x 12.2" / 40 x 31 cm	5734140
5733960	60 QT / 56.75 L	17.7 x 14.4" / 45 x 36.5 cm	5734145

Extra wide loop handles allow for easy pickup when using oven mitts.

Las asas extra anchas permiten un fácil recojo cuando se usan guantes para horno.

Brazier
Includes cover.

Calderos
Incluye tapa.



ITEM #	CAP	DIM (WXH)	REPLACEMENT COVER CUBIERTA DE REPUESTO
5734014	15 QT / 14.2 L	14.2 x 5.7" / 36 x 14.5 cm	5734136
5734019	20 QT / 19 L	15.7 x 6.1" / 40 x 15.5 cm	5734140
5734024	25 QT / 23.75 L	17.7 x 6.1" / 45 x 15.5 cm	5734145
5734030	30 QT / 28.5 L	19.7 x 6.1" / 50 x 15.5 cm	5734150



A photograph of a buffet line with several white trays containing different types of food, including what looks like rice, meat, and vegetables. Serving utensils like tongs and spoons are visible on the trays. The background is slightly blurred, focusing on the food in the foreground.

Buffet & Catering Service

Elegant design meets practicality and functionality in the Browne buffet and catering collection. Flawless presentation is made easy with a range of styles to choose from. Complementary utensils and accessories are available to complete the look.

Servicio de bufé / Catering

El diseño elegante se combina con la practicidad y funcionalidad en la colección de bufé y catering de Browne. Es fácil conseguir una presentación impecable con una variedad de estilos para elegir. Complementos y accesorios están disponibles para completar el look.



OCTAVE COLLECTION

FULL COLLECTION IN
COORDINATING DESIGN -
RECTANGULAR AND ROUND
CHAFERS, SOUP STATIONS,
COFFEE URN & JUICE DISPENSER

- Cover has built-in stop at 140° for single-side serving and fully retracts to 180° for two sided serving
- Automatic tension adjuster keeps cover set in position
- Vents on cover top allow steam to escape
- Cover removes easily without tools, for cleaning
- Mounting studs for option of electric heating

COLECCIÓN OCTAVE

COLECCIÓN COMPLETA
DE DISEÑO COORDINADO:
CALENTADORES
RECTANGULARES Y REDONDOS,
ESTACIONES DE SOPAS,
DISPENSADOR DE CAFÉ Y JUGO

- La cubierta tiene un tope incorporado a 140° para porciones de un solo lado y se retrae completamente a 180° para porciones de dos lados
- El ajustador automático de tensión mantiene la cubierta en su posición.
- Los respiraderos en la cubierta superior permiten que el vapor escape
- La tapa se quita fácilmente sin herramientas para poder limpiarse.
- Pernos de montaje para la opción de calefacción eléctrica



Octave Rectangular Chafin

Dripless drainage system. Full size. Stainless steel.

Calentador inoxidable de mesa rectangular, Octave
A prueba de goteo. Tamaño grande. Acero inoxidable.

ITEM #	CAP	DIM
575170	9 QT / 8.5 L	26.5 x 21.5 x 16" 67.3 x 54.6 x 40.6 cm

PARTS | PARTES

ITEM #	DES	ITEM #	DES
575170-1	Full Size Food Pan Recipiente para alimentos, tamaño grande	575126-5	Fuel Holder Contenedor de combustible
575170-2	Full Size Water Pan Recipiente para agua, tamaño grande	575147	Electric Heater Calentador eléctrico
575170-3	Hinge Assembly Conjunto con bisagra	575175-5	Burner Assembly Conjunto de quemador
		575176-6	Lug Nuts for Burner Assembly Tuercas para el montaje del quemador



Dripless Drainage System

Recycles condensation back to water pan and keeps water off the table. Holes in cover bottom direct condensation to water pan, helping to keep water pan from running dry.

Sistema De Drenaje A Prueba De Goteo

Recicla la condensación de vuelta a la bandeja de agua y mantiene el agua fuera de la mesa. Los orificios en la parte inferior de la cubierta dirigen la condensación hacia el recipiente para agua, lo que ayuda a evitar que el agua gotee sobre la superficie de la mesa.



Octave Round Chafer
Stainless steel.

Calentador inoxidable de mesa redondo, Octave
Acero inoxidable.

ITEM #	CAP	DIM
575171	7 QT / 6.6 L	22.5 x 20" 57.1 x 50.8 cm

PARTS | PARTES

ITEM #	DES	DIM (WXH)
575126-5	Fuel Holder Contenedor de combustible	N/A
575147	Electric Heater Calentador eléctrico	N/A
575165	YING YANG Round Divided Food Pan Recipiente dividido para alimentos 'Yin-Yang'	N/A
575170-3	Hinge Assembly Conjunto con bisagra	N/A
575171-1	Round Food Pan Recipiente para alimentos, tamaño grande	15.3 x 2.6" 38.9 x 6.6 cm
575171-2	Round Water Pan Recipiente para agua, tamaño grande	15.7 x 3.9" 39.9 x 9.9 cm
575176-6	Lug Nuts for Burner Assembly Tuercas para el montaje del quemador	N/A



Octave Soup Station
Stainless steel.

Calentador redondo para sopa, Octave
Acero inoxidable.

ITEM #	CAP	DIM
575172	10.5 QT / 9.9 L	15 x 17.5" 38.1 x 44.5 cm

PARTS | PARTES

ITEM #	DES
575126-5	Fuel Holder Contenedor de combustible
575172-1	Soup Tureen Sopera solamente



Octave Juice Dispenser

Polycarbonate container with stainless steel top and base. Ice cube cylinder keeps drinks cold. Forty four (44) 5 oz / 150 ml servings.

Recipiente para servir jugos

Contenedor de policarbonato con tapa inoxidable. La espita se puede acomodar para abrirse completamente y servir sin necesidad de usar las manos. Espita separable para mayor facilidad de limpieza. Cilindro para hielo mantiene frío el jugo. Cuarenta y cuatro (44) porciones de 5 oz / 150 ml.

ITEM #	CAP	DIM
575174	7 QT / 6.6 L	11 x 12 x 20" 27.9 x 30.5 x 50.8 cm

PARTS | PARTES

ITEM #	DES
575174-3	Ice Holder Cylinder Cilindro para hielo
575179-3	Faucet Espita solamente
575174-1	Plastic Cylinder Cilindro de plástico

Octave Coffee Urn

Faucet can be set to hands-free full open position. Removable faucet for easy cleaning. Forty four (44) 8 oz / 240 ml servings.

Calentador de mesa para café

La espita se puede acomodar para abrirse completamente y servir sin necesidad de usar las manos. Espita separable para mayor facilidad de limpieza. Cuarenta y cuatro (44) porciones de 8 oz / 240 ml.

ITEM #	CAP	DIM
575173	11 QT / 10.4 L	12 x 12.5 x 20" 30.5 x 31.8 x 50.8 cm



PARTS | PARTES

ITEM #	DES
575126-5	Fuel Holder Contenedor de combustible
575179-3	Faucet Espita solamente



HARMONY COLLECTION

FULL COLLECTION IN COORDINATING DESIGN - RECTANGULAR & ROUND CHAFERS, SOUP STATIONS, COFFEE URN & JUICE DISPENSER

- Cover has built-in stop at 140° for single-side serving and fully retracts to 180° for two sided serving
- Automatic tension adjuster keeps cover set in position
- Vents on cover top allow steam to escape
- Cover removes easily without tools, for cleaning
- Mounting studs for option of electric heating

COLECCIÓN HARMONY

COLECCIÓN COMPLETA DE DISEÑO COORDINADO: CALENTADORES RECTANGULARES Y REDONDOS, ESTACIONES DE SOPAS, DISPENSADOR DE CAFÉ Y JUGO.

- La cubierta tiene un tope incorporado a 140° para porciones de un solo lado y se retrae completamente a 180° para porciones de dos lados
- El ajustador automático de tensión mantiene la cubierta en su posición
- Los respiraderos en la cubierta superior permiten que el vapor escape
- La tapa se quita fácilmente sin herramientas para poder limpiarse.
- Pernos de montaje para la opción de calefacción eléctrica



Harmony Rectangular Chafin, Roll Top Cover

Full size rectangular chafin with roll top cover. Vented cover has built-in stop at 140° for single-side serving and fully retracts to 180° for two sided serving. Stainless steel with mirror finish.

Calentador rectangular Harmony con tapa superior

Calentador rectangular con tapa superior. La cubierta ventilada tiene un tope incorporado a 140° para porciones de un solo lado y se retrae completamente a 180° para porciones de dos lados. Acero inoxidable con acabado espejo.

ITEM #	CAP	DIM
575175	9 QT / 8.5 L	26.5 x 21.5 x 17.5" 67.3 x 54.6 x 44.5 cm

PARTES | PARTES

ITEM #	DES	ITEM #	DES
575175-1	Full Size Food Pan Recipiente para alimentos, tamaño grande	575126-5	Fuel Holder Contenedor de combustible
575175-2	Full Size Water Pan Recipiente para agua, tamaño grande	575147	Electric Heater Calentador eléctrico
575170-3	Hinge Assembly Conjunto con bisagra	575175-5	Burner Assembly Conjunto de quemador
		575176-6	Lug Nuts for Burner Assembly Tuercas para el montaje del quemador





Harmony Round Chafer with Roll Top Cover

Round chafer with roll top cover. Vented cover has built-in stop at 140° for single-side serving and fully retracts to 180° for two sided serving. Stainless steel with mirror finish.

Calentador redondo Harmony con tapa superior

Calentador redondo con tapa superior. La cubierta ventilada tiene un tope incorporado a 140° para porciones de un solo lado y se retrae completamente a 180° para porciones de dos lados. Acero inoxidable con acabado espejo.

ITEM #	CAP	DIM
575176	7 QT / 6.6 L	22.5 x 20" 57.1 x 50.8 cm

PARTS PARTES	ITEM #	DES	ITEM #	DES
	575170-3	Hinge Assembly Conjunto con bisagra	575126-5	Fuel Holder Contenedor de combustible
	575176-1	Round Full Size Food Pan Recipiente para alimentos, tamaño grande	575147	Electric Heater Calentador eléctrico
	575176-2	Round Full Size Water Pan Recipiente para agua, tamaño grande	575165	Ying Yang Round Divided Food Pan Recipiente dividido para alimentos 'Yin-Yang'
575176-6	Lug Nuts for Burner Assembly Tuercas para el montaje del quemador	575176-3	Porcelain Food Pan Insert Recipiente de porcelana para alimentos	





Harmony Rectangle Chafer with Nautilus Window Cover

Full size rectangular chafer with clear polycarbonate "fog-resistant" window allows viewing of food without opening cover, greatly reducing heat loss. Vented cover has built-in stop at 140° for single-side serving and fully retracts to 180° for two sided serving. Stainless steel with mirror finish.

Calentador rectangular Harmony Con Ventana Nautilus

Calentador rectangular de tamaño completo con una ventana transparente de policarbonato "resistente al empañamiento" permite ver los alimentos sin abrir la tapa, lo que reduce considerablemente la pérdida de calor. La cubierta ventilada tiene un tope incorporado a 140° para porciones de un solo lado y se retrae completamente a 180° para porciones de dos lados. Acero inoxidable con acabado espejo.

ITEM #	CAP	DIM
575166	9 QT / 8.5 L	26.5 x 21.5 x 17.5" 67.3 x 54.6 x 44.5 cm



ITEM #	DES
575126-5	Fuel Holder Contenedor de combustible
575147	Electric Heater Calentador eléctrico
575170-3	Hinge Assembly Conjunto con bisagra
575175-1	Full Size Food Pan Recipiente para alimentos, tamaño grande
575175-2	Full Size Water Pan Recipiente para agua, tamaño grande
575175-5	Burner Assembly Conjunto de quemador
575176-6	Lug Nuts for Burner Assembly Tuercas para el montaje del quemador

Optional:
Porcelain insert
food pan

Opcional:
Recipiente para
alimentos de
porcelana



575176-3



Harmony Round Chafer with Nautilus Window Cover

Round chafer with clear polycarbonate "fog-resistant" window allows viewing of food without opening cover - greatly reducing heat loss. Vented cover has built-in stop at 140° for single-side serving and fully retracts to 180° for two sided serving. Stainless steel with mirror finish.

Calentador redondo Harmony Con Ventana Nautilus

Calentador redondo de tamaño completo con una ventana transparente de policarbonato "resistente al empañamiento" permite ver los alimentos sin abrir la tapa, lo que reduce considerablemente la pérdida de calor. La cubierta ventilada tiene un tope incorporado a 140° para porciones de un solo lado y se retrae completamente a 180° para porciones de dos lados. Acero inoxidable con acabado espejo.

ITEM #	CAP	DIM
575167	7 QT / 6.6 L	22.5 x 20" 57.1 x 50.8 cm

ITEM #	DES
575126-5	Fuel Holder Contenedor de combustible
575147	Electric Heater Calentador eléctrico
575165	Ying Yang Round Divided Food Pan Recipiente dividido para alimentos 'Yin-Yang'
575170-3	Hinge Assembly Conjunto con bisagra
575176-1	Round Size Food Pan Recipiente para alimentos, tamaño grande
575176-2	Round Size Water Pan Recipiente para agua, tamaño grande
575176-3	Porcelain Food pan insert Recipiente de porcelana para alimentos
575176-6	Lug Nuts for Burner Assembly Tuercas para el montaje del quemador



Harmony Soup Station
Stainless steel.

Calentador redondo para sopa, Harmony
Acero inoxidable.

ITEM #	CAP	DIM
575177	10.5 QT 9.9 L	15 x 17.5" 38.1 x 44.5 cm

PARTS | PARTES

ITEM #	DES
575126-5	Fuel Holder Contenedor de combustible
575177-1	Soup Toureen Espita solamente



Harmony Juice Dispenser

Polycarbonate container with stainless top and base. Faucet can be set to hands-free full open position. Removable faucet for easy cleaning. Ice cylinder keeps drinks cold. Serves forty-four (44) 8 oz / 237 ml portions.

Recipiente para servir jugos

Contenedor de policarbonato con tapa inoxidable. La espita se puede acomodar para abrirse completamente y servir sin necesidad de usar las manos. Espita separable para mayor facilidad de limpieza. Cilindro para hielo mantiene frío el jugo. Porciones 44, 8 oz / 237 ml.

ITEM #	CAP	DIM
575179	7 QT / 6.6 L	11 x 12 x 20" 27.9 x 30.5 x 50.8 cm

PARTS | PARTES

ITEM #	DES
575174-1	Plastic Cylinder Cilindro de plástico
575174-3	Ice Holder Cylinder Cilindro para hielo
575179-3	Faucet Espita solamente



Harmony Coffee Urn

Stainless steel. Faucet can be set to hands-free full open position. Removable faucet for easy cleaning. Serves forty-four (44) 8 oz / 237 ml portions.

Calentador de mesa para café, Harmony

Acero inoxidable. La espita se puede acomodar para abrirse completamente y servir sin necesidad de usar las manos. Espita separable para mayor facilidad de limpieza. Porciones 44, 8 oz / 237 ml.

ITEM #	CAP	DIM
575178	11 QT 10.4 L	12 x 12.5 x 20" 30.5 x 31.8 x 50.8 cm

PARTS | PARTES

ITEM #	DES
575126-5	Fuel Holder Contenedor de combustible
575179-3	Faucet only Espita solamente



SYMPHONY CHAFER

FEATURES HYDRAULIC MECHANISM FOR SMOOTH COVER MOTION

- Clear glass cover means less need to open, saving on energy used to heat food
- Automatic 'stay-open' position at 60° for serving convenience
- Hydraulic mechanism provides smooth cover motion. Auto close at 45°
- Cover removes easily for cleaning and storage
- Mounting studs for optional electric heating

CALENTADOR SYMPHONY

CON MECANISMO HIDRÁULICO PARA UN MOVIMIENTO SUAVE DE LA TAPA

- La tapa de vidrio transparente significa menos necesidad de abrir, lo que ahorra energía utilizada para calentar los alimentos
- Posición automática de permanecer abierta a 60° para una mayor comodidad de servicio
- El mecanismo hidráulico proporciona un movimiento suave de la tapa. Cierre automático a 45°
- La tapa se quita fácilmente para su limpieza y almacenamiento
- Pernos de montaje para la calefacción eléctrica opcional

Full Clear Glass Cover

A clear cover means less need to open the lid, saving on energy used to heat food and helping to control the consistency of the food temperature.

Tapa de vidrio transparente

Una tapa transparente significa menos necesidad de abrirla, ahorrando la energía utilizada para calentar los alimentos y controlando la consistencia de la temperatura de los alimentos.



**Full Size Rectangular Chafer with Glass Cover
Calentador inoxidable de mesa,
rectangular, de tamaño grande**

ITEM #	CAP	DIM
575162	9 QT / 8.5 L	26.5 x 21.5 x 17.5" 67.3 x 54.6 x 44.5 cm

PARTS | PARTES

ITEM #	DES
575126-5	Fuel Holder Contenedor de combustible
575147	Electric Heater Calentador eléctrico
575175-1	Full Size Food Pan Recipiente para alimentos, tamaño grande
575175-2	Full Size Water Pan Recipiente para agua, tamaño grande
575175-5	Burner Assembly Conjunto de quemador
575176-6	Lug Nuts for Burner Assembly Tuercas para el montaje del quemador



Value Chafer Chafer de valor



CADENCE CHAFER

ROLL TOP CHAFER WITH FULL MIRROR FINISH PLUS A VENTED TOP FOR STEAM RELEASE

CALENTADOR CADENCE

CALENTADOR CON PARTE SUPERIOR ABATIBLE EN ACABADO ESPEJO Y UNA PARTE SUPERIOR VENTILADA PARA LIBERAR VAPOR



Cadence Rectangular Chafer
Features a fully retractable cover to 180°, for two-sided serving. Sturdy welded frame, with two stainless steel fuel holders.

Calentador Cadence rectangular
Cuenta con una tapa completamente retráctil a 180°, para servir por ambos lados. Bastidor soldado resistente, con dos soportes de combustible de acero inoxidable.

ITEM #	CAP	DIM
575137	9 QT / 8.5 L	26.5 x 21.5 x 17.5" 67.3 x 54.6 x 44.5 cm

ITEM #	DES
575126-5	Fuel Holder Contenedor de combustible
575175-1	Full Size Food Pan Recipiente para alimentos, tamaño grande

PARTS | PARTES



RONDO CHAFER

FULL MIRROR FINISH. VENTED TOP FOR STEAM RELEASE

CALENTADOR RONDO

LA TAPA SE PUEDE SEPARAR FÁCILMENTE PARA SU LIMPIEZA Y ALMACENAJE



Stainless Steel Rondo Round Chafer
With food and water pan plus stainless steel fuel holder.

Calentador Rondo redondo de acero inoxidable
Con recipientes para comida y para agua.

ITEM #	CAP	DIM
575138	7 QT / 6.6 L	22.5 x 20" 57.1 x 50.8 cm

ITEM #	DES
575126-5	Fuel Holder Contenedor de combustible
575165	YING YANG Round Divided Food Pan Recipiente dividido para alimentos 'Yin-Yang'
575176-1	Round Full Size Food Pan Recipiente para alimentos, tamaño grande
575176-3	Porcelain Food pan insert Recipiente de porcelana para alimentos

PARTS | PARTES



18/8 Stainless Steel Economy Roll Top Chafer
Mirror finish. Top rolls up to 90° for easy serving. Full size 2.5" (6.4 cm) deep food pan. 4" / 10.1 cm deep water pan. Sturdy, welded and stackable frame.

Acero inoxidable 18/8 Calentador de mesa económico con tapa corrediza
Con acabado espejo. La tapa se abre hasta los 90° para un fácil acceso al servir. Recipiente grande para alimentos de 6.4 cm (2.5 pulgadas) de profundidad. Soporte sólido, soldado y apilable.

ITEM #	CAP	DIM
575135	9 QT 8.5 L	25.5 x 15.25 x 15" 64.75 x 38.75 x 38 cm



ITEM #	DES
575126-5	Fuel Holder Contenedor de combustible



Economy Rectangular Chafer
Sturdy, welded and stackable frame with wide "stay cool" handle. Lid clips hold lid in open position. Includes:
 • 1 x Full Size Food Pan (2 1/2" / 6.4 cm deep)
 • 1 x Full Size Water Pan (4" / 10 cm deep, fits 2 1/2" & 4" Food Pans)
 • 2 x Fuel Holders
 • 1 x Full Size Cover

Calentador inoxidable de mesa económico
Marco sólido, soldado y apilable. Asideros anchos "Stay cool". Los clips de la tapa sostienen la tapa en posición abierta. Incluye:
 • 1 recipiente de comida de tamaño completo (6,4 cm / 2,5 pulg. de profundidad)
 • 1 recipiente de agua de tamaño completo 10 cm / 4 pulg. de profundidad, para bandejas de comida de 6,4 cm / 2,5 pulg. y de 10 cm / 4 pulg.)
 • 2 soportes de combustible
 • 1 tapa de tamaño completo

ITEM #	CAP	DIM
575126	9 QT 8.5 L	23.6 x 13.8 x 12.6" 60 x 35 x 32 cm



ITEM #	DES
575126-2	Water Pan Recipiente para agua



Electric Heater for Chafers
For round and rectangular chafers. 120 volts, 700 watts. Supplied with 8' / 2.43 m power cord. Constant power. CSA/CUL approved. Compatible with 575170, 575171, 575175, 575176, 575166, 575167, and 575162

Calentador eléctrico
Para calentadores de mesa redondos y rectangulares. 120 voltios, 700 vatios. Viene con cordón eléctrico de 2.43 m (8 pies). Energía constante. Aprobado por CSA y CUL. Compatible con 575170, 575171, 575175, 575176, 575166, 575167, and 575162

ITEM #	DIM
575147	10 x 8" / 25.4 x 20.3 cm



Chafer Fuel Holder
Fits all Browne chafers. Stainless steel with a sliding cover.

Contenedor de combustible
Cabe en todos los recipientes calentadores Browne. Acero inoxidable con tapa deslizable.

ITEM #	DIM
575126-5	3.5" / 8.9 cm



Cereal Dispenser

Removable stainless steel top. Four-arm handle controls composite 6 blade windmill. Polycarbonate clear cylinder. Stainless steel base with 4 ball feet. Indentation on base to secure serving bowl.

Dispensador de cereales

Tapa separable de acero inoxidable. Manivela de cuatro ramas que controla el molinete con 6 paletas de material compuesto. Cilindro transparente de policarbonato. Base de acero inoxidable con 4 patas en forma de bola. Base con hendidura para el bol de cereales.

ITEM #	CAP	DIM
575161	11.6 QT 11 L	13.75 x 10.2 x 27" 35 x 25 x 68.5 cm



Stainless Steel Polygonal Beverage Dispenser

Polycarbonate construction with 12-sided clear cylinder. Removable faucet with hands-free full open setting. Sealed-bottom cylinder for cubed or crushed ice to keep drinks cold. Removable drip tray with 4.3 oz / 126 ml capacity. Forty-four (45) 5 oz / 150 ml servings.

Dispensador poligonal de bebidas

Cilindro transparente de 12 lados. Acero inoxidable y policarbonato. Espita separable que se puede abrir completamente para servir sin necesidad de usar las manos. Cilindro con fondo sellado para cubitos de hielo o hielo machacado que mantiene frío el jugo. Bandeja recogegotas separable con 126 ml (4.3 onzas) de capacidad. Cuarenta y cinco (45) porciones de 5 oz / 150 ml.

ITEM #	CAP	DIM
575160	7 QT 6.6 L	14 x 9.6 x 20.75" 36 x 24 x 53 cm

PARTS | PARTES

DES	ITEM #	DES	ITEM #
Faucet Espita solamente	575179-3	Lid only Cubierta	575160-1
Plastic Cylinder Cilindro de plástico	575160-3		



Ying/Yang Divided Food Pan

Fits all round chafers.

Recipiente dividido para alimentos 'Yin-Yang'

Cabe en todos los calentadores redondos

ITEM #	CAP	DIM
575165	5.5 QT / 5.2 L	15.25 x 2.75" 38.7 x 7 cm



Porcelain Insert Food Pan

Fits all round chafers.

Recipiente de porcelana para alimentos

Cabe en todos los calentadores redondos.

ITEM #	CAP	DIA
575176-3	9 QT / 8.5 L	13.75" 34.9 cm



ECLIPSE SERVING TOOLS

ELEGANT AND PRACTICAL
SERVING TOOLS, IDEAL FOR
BUFFETS, SERVING STATIONS
AND CATERING

- "Stay Cool" hollow handle resists heat build-up
- Tapered design provides comfortable grip
- Durable 18/8 stainless steel construction, in mirror and satin finish
- Large collection in a range of sizes for all your serving requirements



UTENSILIOS DE SERVIR ECLIPSE

ELEGANTES UTENSILIOS PARA
SERVIR PARTÍCULAS, IDEALES
PARA BUFÉS, ESTACIONES DE
SERVICIO Y CATERING.

- El mango hueco "Stay Cool" resiste la acumulación de calor
- El diseño cónico proporciona un agarre cómodo
- El mango arqueado de diseño único asegura un fácil recojo y reduce el deslizamiento al servir
- Construcción duradera de acero inoxidable 18/8, en acabado espejo y satinado
- Gran colección en dos gamas de tamaños para todas sus necesidades de servicio.





Unique arc handle ensures easy pick up and reduced slippage when serving

El mango arqueado de diseño único asegura un fácil recojo y reduce el deslizamiento al servir

Tapered design provides comfortable grip

El diseño cónico proporciona un agarre cómodo



Mirror Finish | Acabado Espejo



Satin Finish | Acabado Satinado

Pie Server
Pala para servir tartas

Satin Finish | Acabado Satinado

573283 10" / 25.5 cm

Mirror Finish | Acabado Espejo

ITEM # DIM
573183 10" / 25.5 cm



Mirror Finish
Acabado Espejo



Satin Finish
Acabado Satinado

Turner
Pala

Satin Finish | Acabado Satinado

ITEM #	DES	DIM
573271	Solid Sólida	14" / 35.5 cm
573272	Slotted Ranurada	14" / 35.5 cm

Mirror Finish | Acabado Espejo

ITEM #	DES	DIM
573171	Solid Sólida	14" / 35.5 cm
573172	Slotted Ranurada	14" / 35.5 cm



573175



573182

Serving Fork
Mirror Finish

Tenedor para servir
Acabado Espejo

ITEM #	DES	DIM
573182	3 Prongs 3 Puntas	10" / 25.5 cm
573175	2 Prongs 2 Puntas	13.5" / 34 cm



Mirror Finish | Acabado Espejo

Satin Finish | Acabado Satinado

Spoon Cucharas

Satin Finish | Acabado Satinado

ITEM #	DES	DIM
573280	Solid Sólida	10" / 25.5 cm
573273	Solid Sólida	13" / 33 cm
573281	Slotted Ranurada	10" / 25.5 cm
573274	Slotted Ranurada	13" / 33 cm

Mirror Finish | Acabado Espejo

ITEM #	DES	DIM
573180	Solid Sólida	10" / 25.5 cm
573173	Solid Sólida	13" / 33 cm
573181	Slotted Ranurada	10" / 25.5 cm
573174	Slotted Ranurada	13" / 33 cm



Wide Tongs Mirror Finish

Pinzas para servir Acabado Espejo

ITEM #	DIM
573190	12" / 30.5 cm

Satin Finish
Acabado SatinadoMirror Finish
Acabado Espejo

Serving Ladle Cucharones para servir

Satin Finish | Acabado Satinado

ITEM #	CAP	DIM
573284	1 oz / 29 ml	10" / 25.5 cm
573270	6 oz / 177 ml	14" / 35.5 cm

Mirror Finish | Acabado Espejo

ITEM #	CAP	DIM
573184	1 oz / 29 ml	10" / 25.5 cm
573185	1 oz / 29 ml	12" / 30.5 cm
573170	6 oz / 177 ml	15" / 38 cm



Pom Tongs Mirror Finish

Pinzas para servir Pom Acabado Espejo

ITEM #	DIM
573192	6" / 15 cm
573194	9" / 23 cm



Bar Tongs Mirror Finish

Pinzas de bar Acabado Espejo

ITEM #	DIM
57540	7" / 18 cm





Serving Tong
Pinzas para servir

Satin Finish | Acabado Satinado

ITEM #	DIM
573286	6" / 15 cm
573287	9.5" / 24 cm
573288	12" / 30.5 cm

Mirror Finish Acabado Espejo

ITEM #	DIM
573186	6" / 15.3 cm
573187	9.5" / 24 cm
573188	12" / 30.5 cm



Offset Serving Tong
Pinzas para servir

Mirror Finish

Acabado Espejo

ITEM #	DIM
57567	9" / 22.9 cm
57568	12" / 30.5 cm



Stainless Steel Spoon
Rest
Apoya-cuchara

Mirror Finish

Acabado Espejo

ITEM #	DIM
575199	10.5 x 4.5" 26.7 x 11.4 cm



10" Service Tongs
18/8 Stainless steel.
Mirror finish.
1.5 mm thickness.

Pinzas para servir
Acero inoxidable 18/8.
Acabado espejo.
1.5 mm de espesor.

ITEM #	DIM
746144	10" / 25.4 cm



Food grade nylon, reinforced with fiberglass for higher heat resistance

Ideal for self serve waffle stations and for back of house use.

Nylon de grado alimentario, reforzado con fibra de vidrio para una mayor resistencia al calor

Ideal para estaciones de waffles de autoservicio y para uso doméstico



ITEM # DIM
57476502 10.5" / 25.4 cm

Waffle Iron Fork
Safe for use on non-stick surfaces.
Commercial dishwasher safe.
Heat resistant up to 550° F / 288° C.

Tenedor de hierro para waffles
Seguro para usar en superficies antiadherentes. Seguro para el lavavajillas comercial. Resistente al calor hasta 550° F / 288° C.



ELITE SERVING UTENSILS

MIRROR FINISH.
STAINLESS STEEL. ONE-PIECE CONSTRUCTION.
HOLLOW HANDLES.
2.5 MM THICKNESS.

UTENSILIOS DE SERVIR ELITE

ACABADO ESPEJO, ACERO INOXIDABLE, MOLDEADO DE UNA PIEZA, MANGO HUECO. 2.5 MM DE ESPESOR.



Spout Ladle
Cucharones con pico para verter

ITEM #	DIM
573153	11" / 28 cm 2 oz / 59 ml
573142	11" / 28 cm 1 oz / 29 ml



Deep Serving Ladle
Cucharón para servir profundo

ITEM #	DIM
573152	13.4" / 34 cm 3.65 oz / 108 ml



Serrated Knife
Cuchillo con hoja dentada, borde ondulado

ITEM #	DIM
573151	13.5" / 34.2 cm



Solid Serving Spoon
Cuchara para servir sólida

ITEM #	DIM
573154	11.8" / 30 cm



Slotted Serving Spoon
Cuchara para servir con ranuras

ITEM #	DIM
573155	11.8" / 30 cm



Notched Serving Spoon
Cuchara para servir con hendidura

ITEM #	DIM
573156	11.6" / 29.5 cm



Cold Meat Fork
Tenedor para fiambres

ITEM #	DIM
573141	10.5" / 26 cm



Pot Fork
Tenedor para ollas

ITEM #	DIM
573150	11" / 28 cm



Pie Server
Pala para servir tartas

ITEM #	DIM
573159	11" / 28 cm



Pastry Server
Pala para servir pasteles

ITEM #	DIM
573158	11" / 28 cm



MODENA SERVING UTENSILS

BEAUTIFUL, FUNCTIONAL DESIGN. COMPLIMENTS OUR MODENA FLATWARE PATTERN

- 18/10 stainless steel satin polished serving area with satin handles
- 4 mm thickness

UTENSILIOS DE SERVIR MODENA

HERMOSO DISEÑO FUNCIONAL. COMPLEMENTA NUESTRO MODELO DE CUBIERTOS DE MÓDENA

- Área de servicio pulida con acabado espejo de acero inoxidable 18/10 con mangos de satén
- 4 mm de espesor



Serving Ladle
Cucharones para servir

ITEM #	DIM
573164	9.25" / 23.5 cm 1.25 oz / 40 ml



Pie Server
Pala para servir tartas

ITEM #	DIM
573163	9.8" / 25 cm



NEW ERA SERVING UTENSILS

MIRROR FINISH. STAINLESS STEEL. ONE-PIECE STAMPED CONSTRUCTION. 1.5 MM THICKNESS

UTENSILIOS DE SERVIR NEW ERA

ACABADO ESPEJO. ACERO INOXIDABLE. CONSTRUCCIÓN DE UNA PIEZA ESTAMPADA. 1.5 MM DE ESPESOR



Cold Meat Fork
Tenedor para fiambres

ITEM #	DIM
820	8.5" / 21.6 cm



Square Bowl Serving Spoon
Cuchara para servir cuadrada

ITEM #	DIM
817	8.5" / 21.6 cm



Round Bowl Serving Spoon
Cuchara para servir redonda

ITEM #	DIM
818	8" / 20.8 cm



Serving Ladle
Cucharones para servir

ITEM #	DIM / CAP
819	6.5" / 16.6 cm 0.5 oz / 15 ml



DELIVERY BAGS

KEEP HOT FOOD HOT AND COLD FOOD COLD WITH DELIVERY BAGS FROM BROWNE FOODSERVICE.

- Maintain temperatures for up to 35 minutes
- Durable and water resistant polyester exterior
- Thermal reflective aluminum interior
- Reinforced straps for easy carrying
- Window pockets for storing slips, and menus. Mesh pockets for extra storage space

BOLSAS DE ENTREGA

MANTENGA LOS ALIMENTOS CALIENTES, CALIENTES Y LOS ALIMENTOS FRÍOS, FRÍOS CON LAS BOLSAS DE ENTREGAS DE BROWNE FOODSERVICE.

- Conserva las temperaturas hasta por 35 minutos
- Exterior de poliéster, durable y resistente al agua
- Interior de aluminio reflector térmico
- Correas reforzadas para facilitar su transporte
- Bolsillo transparente para guardar talones y menús. Bolsillos de malla para almacenamiento adicional



575389



575390



575391

Delivery Bags

Outer material is 600 denier polyester in grey with black edging and aluminum film, insulated interior.

Bolsas de entrega

El material externo es poliéster 600 negacionista de color gris con un interior aislado de borde negro y forrado en aluminio

ITEM #	DES	DIM	CAP
575389	Delivery Bag Bolsa de entrega	23 x 15 x 14" 58.5 x 38 x 35.cm	Footprint can fit a full size steam pan comfortably En Footprint cabe cómodamente una bandeja completa de vapor
575390	Delivery Bag Bolsa de entrega	16 x 14 x 14" 40.5 x 35.5 x 35.cm	Footprint can fit a 2/3 steam pan comfortably En Footprint cabe cómodamente 2/3 de bandeja de vapor
575391	Pizza Delivery Bag Bolsa para entrega de pizza	20 x 20 x 6.5" 50.75 x 50.75 x 16.5 cm	Can hold 3 extra large pizza boxes Cabén 3 cajas de pizza extra grandes



Table Top

Front of house creates the ambience, tells your story and works in partnership with the food you serve to create the overall experience. From everyday basics to specialty items Browne's collection of tabletop and dining room accessories offers quality, selection and variety to help you create your personalized look.

Servicio de Mesa

La hospitalidad crea el ambiente, cuenta tu historia y trabaja en asociación con la comida que sirves para crear la experiencia general. Desde elementos básicos de uso cotidiano hasta artículos especiales

La colección de accesorios de servicio de mesa y comedor de Browne ofrece calidad, selección y variedad para ayudarle a crear un aspecto personalizado.

BROWNE'S FLATWARE OVERVIEW

CUBIERTOS DE BROWNE RESUMEN

**Represent 5 pieces place settings |



















**Juego de 5 piezas

Flatware Item NumberExample : **LUNA** Teaspoon : **5032**Last Two Digits of **Teaspoon 23****5032 + 23 = 503223**

▲ 3 tine | 3 dents

■ 4 tine | 4 dents

Número de ítem para cubiertosEjemplo : LUNA Cucharilla : **5032**Últimos dos dígitos de **cucharilla 23****5032 + 23 = 503223**

		Luna	Eclipse	Modena	Concerto	Lumino	Bistro	Lafayette	Oxford	Contour	Celine	Paris	Elegance	Royal	WIN2	Windsor	Dominion	
		18/10	18/10	18/10	18/10	18/0	18/0	18/0	18/0	18/0	18/0	18/0	18/0	18/0	18/0	18/0	18/0	
SPOONS / CUCHARA		50 32	50 21	50 30	50 24	50 14	50 23	50 22	50 20	50 29	50 25	50 19	50 27	50 26	50 38	50 28	55	
Teaspoon Cucharita de té		●	●	●	●	●	●	●	●	●	●	●	●	●	●	●	23	02
Tablespoon Cucharita de mesa		●	●	●	●		●	●	●		●	●		●		●	04	
Oval Dessert Spoon Cucharita oval de postre		●	●	●	●	●	●	●	●	●	●	●	●	●	●	●	02	04
Round Soup Spoon Cucharita de sopa redonda		●	●	●	●	●	●	●	●	●	●	●	●	●	●	●	13	
Bouillon Spoon Cucharita para consomé		●	●	●	●	●	●	●			●	●		●	●	●	17	09
Iced Tea Spoon Cucharita de té helado		●	●	●		●	●	●		●	●	●	●	●		●	14	06
Demi Tasse Spoon Cucharita de café		●	●	●		●	●		●	●	●	●	●	●		●	25	
FORKS / TENEDORES																		
European Fork Tenedor europeo		●	●	●	●	●	●	●	●		●	●					05	
Large Dinner Fork Tenedor de mesa grande											●						06	
Dinner Fork Tenedor de mesa		●	●	●	●	●	●	●	●	●	●	●	●	●	●	●	03	03
Salad Fork Tenedor para ensaladas		●	●	●	●	●	●	●	●	●	●	●	●	●	●	●	10	08
Oyster Fork Tenedor para ostras			▲	▲				▲		■	■		▲	▲		▲	15	07
Snail Fork Tenedor para escargot									●		●					●	16	23
KNIVES / CUCHILLOS																		
Spreader Cuchillo para untar			●	●			●	●	●	●	●			●			22	
Dinner Knife* Cuchillo de mesa																	11	
Dinner Knife Serrated* Cuchillo de mesa serrado		●	●	●	●	●	●	●	●	●	●	●	●	●	●	●	11S	00W
Steak Knife Cuchillo para carne			●	●	●					●	●						12	
Dessert / Butter Knife Cuchillo de postre / mantequilla		●	●	●	●	●	●	●	●	●	●	●					21	



LUNA

18/10 STAINLESS STEEL. MIRROR FINISH.
ACERO INOXIDABLE 18/10. PULIDO ESPEJO.



Knives 13/0. 3.0 mm* Cuchillos 13/0. 3.0 mm*

ITEM #	DES	DIM
503202	Dessert Spoon** Cuchara de postre**	7" / 18 cm
503203	Dinner Fork** Tenedor de mesa**	7.5" / 19 cm
503204	Tablespoon Cuchara de mesa	8.25" / 21 cm
503205	European Fork Tenedor europeo	8.25" / 21 cm
503210	Salad Fork** Tenedor para ensalada**	6.5" / 16.5 cm
503211S	Dinner Knife Serrated, 100 gr** Cuchillo de mesa dentado 100 gr**	9.5" / 24 cm
503213	Round Soup Spoon Cuchara redonda de sopa	7.25" / 18 cm
503214	Iced Tea Spoon Cuchara para té helado	7.25" / 18 cm
503217	Bouillon Spoon Cuchara para consomé	5.7" / 14.5 cm
503221	Dessert Knife Cuchillo de postre	7" / 18 cm
503223	Teaspoon** Cuchara de té**	5.7" / 14.5 cm
503225	Demi Tasse Spoon Cucharita de café	5" / 12.8 cm

**Represent 5 pieces place settings |
**Juego de 5 piezas



ECLIPSE

18/10 STAINLESS STEEL. MIRROR FINISH.
ACERO INOXIDABLE 18/10. PULIDO ESPEJO.



Knives 13/0. 4.0 mm* Cuchillos 13/0. 4.0 mm*

ITEM #	DES	DIM
502102	Dessert Spoon** Cuchara de postre**	7.1" / 18.1 cm
502103	Dinner Fork** Tenedor de mesa**	7.1" / 18.1 cm
502104	Tablespoon Cuchara de mesa	8" / 20.3 cm
502105	European Fork Tenedor europeo	8.3" / 23.1 cm
502110	Salad Fork** Tenedor para ensalada**	6.5" / 16.5 cm
502111S	Dinner Knife Serrated, 108 gr** Cuchillo de mesa dentado, 108 gr**	9.1" / 23.1 cm
502112	Steak Knife Serrated Cuchillo para carne dentado	9.3" / 23.5 cm
502113	Round Soup Spoon Cuchara redonda de sopa	7" / 17.8 cm
502114	Iced Tea Spoon Cuchara para té helado	7.4" / 18.7 cm
502115	Oyster Fork Tenedor para ostras	5.8" / 14.6 cm
502117	Bouillon Spoon Cuchara para consomé	6" / 15.2 cm
502121	Dessert Knife Cuchillo de postre	7.1" / 18.1 cm
502122	Butter Spreader Bent Pala para servir mantequilla, curvada	7" / 17.8 cm
502123	Teaspoon** Cuchara de té**	6.3" / 15.9 cm
502125	Demi Tasse Spoon Cucharita de café	5" / 12.7 cm

**Represent 5 pieces place settings |
**Juego de 5 piezas

*Thickness refers to dinner fork | *El grosor se refiere al tenedor de mesa.



MODENA

18/10 STAINLESS STEEL. SATIN FINISH
ACERO INOXIDABLE 18/10. PULIDO SATINADO.



Knives 13/0. 3.5 mm* Cuchillos 13/0. 3.5 mm*

ITEM #	DES	DIM
503002	Dessert Spoon** Cuchara de postre**	7.3" / 18.4 cm
503003	Dinner Fork** Tenedor de mesa**	7.3" / 18.4 cm
503004	Tablespoon Cuchara de mesa	8.1" / 20.6 cm
503005	European Fork Tenedor europeo	8.1" / 20.6 cm
503010	Salad Fork** Tenedor para ensalada**	6.5" / 16.5 cm
503011S	Dinner Knife Serrated, 100 gr** Cuchillo de mesa dentado, 100 gr**	8.9" / 22.5 cm
503012	Steak Knife Serrated Cuchillo para carne dentado	9.3" / 23.5 cm
503013	Round Soup Spoon Cuchara redonda de sopa	7" / 17.8 cm
503014	Iced Tea Spoon Cuchara para té helado	7.3" / 18.4 cm
503015	Oyster Fork Tenedor para ostras	5.7" / 14.3 cm
503017	Bouillon Spoon Cuchara para consomé	6" / 15.2 cm
503021	Dessert Knife Cuchillo de postre	7.1" / 18.1 cm
503022	Butter Spreader Bent Pala para servir mantequilla, curvada	7" / 17.8 cm
503023	Teaspoon** Cuchara de té**	6.3" / 15.9 cm
503025	Demi Tasse Spoon Cucharita de café	5" / 12.7 cm

**Represent 5 pieces place settings |

**Juego de 5 piezas



Serving Tools. Satin Finish. 4 mm thick Utensilios de servir. Acabado satinado. 4 mm de espesor

ITEM #	DES	DIM
573163	Pie Server Pala para servir tartas	9.8" / 25 cm
573164	Serving Ladle Cucharón para servir	9.25" / 23.5 cm 1.25 oz / 40 ml

*Thickness refers to dinner fork | *El grosor se refiere al tenedor de mesa.



CONCERTO

18/10 STAINLESS STEEL. MIRROR FINISH.
ACERO INOXIDABLE 18/10. PULIDO ESPEJO.



Knives 13/0. 3.0 mm* Cuchillos 13/0. 3.0 mm*

ITEM #	DES	DIM
502402	Dessert Spoon** Cuchara de postre*	7.1" / 18.1 cm
502403	Dinner Fork** Tenedor de mesa**	7.3" / 18.4 cm
502404	Tablespoon Cuchara de mesa	8.1" / 20.6 cm
502405	European Fork Tenedor europeo	8.3" / 21 cm
502410	Salad Fork** Tenedor para ensalada**	6.5" / 16.5 cm
502411S	Dinner Knife Serrated, 100 gr** Cuchillo de mesa dentado, 100 gr**	9" / 22.9 cm
502412	Steak Knife Serrated Cuchillo para carne dentado	9.3" / 23.5 cm
502413	Round Soup Spoon Cuchara redonda de sopa	7" / 17.8 cm
502417	Bouillon Spoon Cuchara para consomé	6.5" / 15.9 cm
502421	Dessert Knife Cuchillo de postre	7" / 17.8 cm
502423	Teaspoon** Cuchara de té**	6.3" / 15.9 cm

**Represent 5 pieces place settings |
**Juego de 5 piezas

Volume Guide

Knowing how much flatware to buy can be confusing. There are many factors to consider including the number of seats, turnover rate, any specialty items on the menu, warewashing capacity, type of operation (fine dining, family style, cafeteria, etc.) and backup inventory requirements.

For example, the amount of teaspoons needed for a fine dining restaurant with 125 seats would be $125 \times 5 = 625$. Round down to $624 = 52$ dozen

Guía de volúmenes

Saber cuántos cubiertos comprar podría ser confuso. Hay muchos factores que considerar, incluyendo la cantidad de asientos, el índice de reposición, cualquier especialidad del menú, la capacidad del lavado de utensilios, el tipo de local (restaurante fino, restaurante familiar, cafetería, etc.) y los requisitos de respaldo del inventario.

Por ejemplo, la cantidad de cucharitas que se necesitan para un restaurante fino con 125 asientos

18/10 vs 18/0

When looking at stainless steel grades, the first number refers to chromium and the second number represents the amount of nickel in the flatware.

- 18/10 flatware: 18% Chromium, 10% Nickel
- 18/0 flatware: 18% Chromium, no Nickel

Choose 18/0 flatware

If you want a soft sheen and economic value. Ideal for casual dining or high volume establishments.

Choose 18/10 flatware

If you want high shine and quality. The perfect choice for fine dining and foodservice providers that offer a luxury experience.

18/10 vs 18/0

Cuando observamos los grados de acero inoxidable, el primer número se refiere al cromo y el segundo número representa la cantidad de níquel en el cubierto.

- Cubiertos 18/10: 18% cromo, 10% níquel
- 18/0 cubiertos: 18% cromo, no níquel.

El cromo es un metal durable que resiste las manchas, el óxido y la corrosión. El níquel es un metal resistente a la corrosión que se agrega al acero inoxidable para aumentar su brillo y lustre.

Elija cubiertos 18/0 si desea un brillo suave y un valor económico. Ideal para cenas casuales o establecimientos para gran cantidad de personas. Elija cubiertos 18/10 si desea un brillo fuerte y buena calidad. La perfecta elección para cenas elegantes y proveedores de servicios de alimentos que ofrecen una experiencia de lujo.





LUMINO



18/0 STAINLESS STEEL. MIRROR FINISH.
ACERO INOXIDABLE 18/0. PULIDO ESPEJO.



Knives 13/0. 4.5 mm* Cuchillos 13/0. 4.5 mm*

ITEM #	DES	DIM
501402	Dessert Spoon** Cuchara de postre**	8.5" / 21.5 cm
501403	Dinner Fork** Tenedor de mesa**	8.25" / 21 cm
501405	European Fork Tenedor europeo	9" / 23 cm
501410	Salad Fork** Tenedor para ensalada**	7" / 18 cm
501411S	Dinner Knife Serrated, 125 gr** Cuchillo de mesa dentado, 125 gr**	9.5" / 24 cm
501413	Round Soup Spoon Cuchara redonda de sopa	7.8" / 20 cm
501414	Iced Tea Spoon Cuchara para té helado	7.5" / 19 cm
501417	Boullion Spoon Cuchara para consomé	6.5" / 16.5 cm
501421	Butter Knife Pala para servir mantequilla	7" / 18 cm
501423	Teaspoon** Cuchara de té**	6.1" / 15.5 cm
501425	Demi Tasse Spoon Cucharita de café	4.75" / 12 cm

**Represent 5 pieces place settings | **Juego de 5 piezas

*Thickness refers to dinner fork | *El grosor se refiere al tenedor de mesa.





BISTRO

18/0 STAINLESS STEEL. MIRROR FINISH.
ACERO INOXIDABLE 18/0. PULIDO ESPEJO.



Knives 13/0. 3.0 mm* Cuchillos 13/0. 3.0 mm*

ITEM #	DES	DIM
502302	Dessert Spoon** Cuchara de postre**	7.3" / 18.4 cm
502303	Dinner Fork** Tenedor de mesa**	7.3" / 18.4 cm
502304	Tablespoon Cuchara de mesa	8.3" / 21 cm
502305	European Fork Tenedor europeo	8" / 20.3 cm
502310	Salad Fork** Tenedor para ensalada**	6.5" / 16.5 cm
502311S	Dinner Knife Serrated, 125 gr** Cuchillo de mesa dentado, 125 gr**	9" / 22.9 cm
502313	Round Soup Spoon Cuchara redonda de sopa	7" / 17.8 cm
502314	Iced Tea Spoon Cuchara para té helado	7.5" / 19 cm
502317	Bouillon Spoon Cuchara para consomé	6.5" / 15.9 cm
502321	Butter Knife Pala para servir mantequilla	7.2" / 18.4cm
502323	Teaspoon** Cuchara de té**	6.5" / 16.4cm
502325	Demi Tasse Spoon Cucharita de café	4.4" / 11.3cm

*Thickness refers to dinner fork | *El grosor se refiere al tenedor de mesa.



LAFAYETTE

18/0 STAINLESS STEEL. MIRROR FINISH.
ACERO INOXIDABLE 18/0. PULIDO ESPEJO.



OXFORD

18/0 STAINLESS STEEL. MIRROR FINISH.
ACERO INOXIDABLE 18/0. PULIDO ESPEJO.



*Thickness refers to dinner fork | *El grosor se refiere al tenedor de mesa.



Knives 13/0. 2.8 mm* Cuchillos 13/0. 28 mm*

ITEM #	DES	DIM
502202	Dessert Spoon** Cuchara de postre**	7.3" / 18.4 cm
502203	Dinner Fork** Tenedor de mesa**	7.5" / 19 cm
502205	European Fork Tenedor europeo	8.3" / 21 cm
502210	Salad Fork** Tenedor para ensalada**	6.5" / 16.5 cm
502211S	Dinner Knife Serrated, 105 gr** Cuchillo de mesa dentado, 105 gr**	9.3" / 23.5 cm
502213	Round Soup Spoon Cuchara redonda de sopa	7" / 17.8 cm
502214	Iced Tea Spoon Cuchara para té helado	7.3" / 18.4 cm
502215	Oyster Fork Tenedor para ostras	5.8" / 14.6 cm
502217	Bouillon Spoon Cuchara para consomé	7" / 17.8 cm
502221	Dessert Knife Cuchillo de postre	7.1" / 18 cm
502222	Butter Spreader Bent Pala para servir mantequilla	7" / 17.8 cm
502223	Teaspoon** Cuchara de té**	6.1" / 15.6 cm

**Represent 5 pieces place settings |
**Juego de 5 piezas



Knives 13/0. 3.0 mm* Cuchillos 13/0. 3.0 mm*

ITEM #	DES	DIM
502002	Dessert Spoon** Cuchara de postre**	7.1" / 18.1 cm
502003	Dinner Fork** Tenedor de mesa**	7.4" / 19.4 cm
502005	European Fork Tenedor europeo	8.1" / 20.6 cm
502010	Salad Fork** Tenedor para ensalada**	6.7" / 16 cm
502011S	Dinner Knife Serrated, 95 gr** Cuchillo de mesa dentado, 95 gr**	9.3" / 23.5 cm
502013	Round Soup Spoon Cuchara redonda de sopa	7.3" / 18.4 cm
502016	Snail Fork Tenedor para caracoles	6.5" / 16.5 cm
502021	Dessert Knife Cuchillo de postre	7.1" / 18.1 cm
502022	Butter Spreader Bent Pala para servir mantequilla, curvada	6.4" / 16.2 cm
502023	Teaspoon** Cuchara de té**	6.3" / 15.9 cm
502025	Demi Tasse Spoon Cucharita de café	5" / 12.7 cm

**Represent 5 pieces place settings | **Juego de 5 piezas



CONTOUR

18/0 STAINLESS STEEL. MIRROR FINISH.
ACERO INOXIDABLE 18/0. PULIDO ESPEJO.



PARIS

18/0 STAINLESS STEEL. MIRROR FINISH.
ACERO INOXIDABLE 18/0. PULIDO ESPEJO.



*Thickness refers to dinner fork | *El grosor se refiere al tenedor de mesa.



Knives 13/0. 2.8 mm* Cuchillos 13/0. 2.8 mm*

ITEM #	DES	DIM
502902	Dessert Spoon** Cuchara de postre**	7.5" / 17 cm
502903	Dinner Fork** Tenedor de mesa**	7.8" / 19.7 cm
502910	Salad Fork** Tenedor para ensalada**	6.5" / 16.5 cm
502911S	Dinner Knife Serrated, 85 gr** Cuchillo de mesa dentado, 85 gr**	8.9" / 22.5 cm
502912	Steak Knife Serrated Cuchillo para carne dentado	9.3" / 23.5 cm
502913	Round Soup Spoon Cuchara redonda de sopa	7.1" / 18 cm
502914	Iced Tea Spoon Cuchara para té helado	7.5" / 17 cm
502915	Oyster Fork Tenedor para ostras	6" / 15.2 cm
502917	Bouillon Spoon Cuchara para consomé	6.3" / 18 cm
502923	Teaspoon* Cuchara de te*	6.5" / 16.5 cm
502925	Demi Tasse Spoon Cucharita de café	5" / 12.7 cm

**Represent 5 pieces place settings |
**Juego de 5 piezas



Knives 13/0. 3.0 mm* Cuchillos 13/0. 3.0 mm*

ITEM #	DES	DIM
501902	Dessert Spoon** Cuchara de postre**	7.3" / 18.4 cm
501903	Dinner Fork** Tenedor de mesa**	7.3" / 18.4 cm
501904	Tablespoon Cuchara de mesa	8.1" / 20.6 cm
501905	European Fork Tenedor europeo	8.1" / 20.6 cm
501910	Salad Fork** Tenedor para ensalada**	6.5" / 16.5 cm
501911S	Dinner Knife Serrated, 95 gr** Cuchillo de mesa dentado, 95 gr**	8.9" / 22.5 cm
501913	Round Soup Spoon Cuchara redonda de sopa	7" / 17.8 cm
501914	Iced Tea Spoon Cuchara para té helado	7.3" / 18.4 cm
501917	Bouillon Spoon Cuchara para consomé	6" / 15.2 cm
501923	Teaspoon** Cuchara de té**	6.3" / 15.8 cm
501925	Demi Tasse Spoon Cucharita de café	5" / 12.7 cm
501926	Contemporary Teaspoon Cucharita de té	6.5" / 16 cm

**Represent 5 pieces place settings | **Juego de 5 piezas

CELINE

18/0 STAINLESS STEEL. MIRROR FINISH.
ACERO INOXIDABLE 18/0. PULIDO ESPEJO.



ELEGANCE

18/0 STAINLESS STEEL. SATIN FINISH
ACERO INOXIDABLE 18/0. PULIDO SATINADO



Knives 13/0. 3.0 mm* Cuchillos 13/0. 3.0 mm*

ITEM #	DES	DIM
502502	Dessert Spoon** Cuchara de postre**	7.3" / 18.4 cm
502503	Dinner Fork** Tenedor de mesa**	7.3" / 18.4 cm
502504	Tablespoon Cuchara de mesa	8.3" / 23.1 cm
502505	European Fork Tenedor europeo	8" / 20.3 cm
502506	Large Dinner Fork Tenedor de mesa	8.3" / 23.1 cm
502510	Salad Fork** Tenedor para ensalada**	6.5" / 16.5 cm
502511S	Dinner Knife Serrated, 95 gr** Cuchillo de mesa dentado, 95 gr**	9" / 22.9 cm
502512	Steak Knife Serrated Cuchillo para carne dentado	9.3" / 23.5 cm
502513	Round Soup Spoon Cuchara redonda de sopa	7" / 17.8 cm
502514	Iced Tea Spoon Cuchara para té helado	7.5" / 17 cm
502515	Oyster Fork Tenedor para ostras	5.9" / 15 cm
502516	Snail Fork Tenedor para caracoles	6.5" / 16.5 cm
502517	Bouillon Spoon Cuchara para consomé	6.5" / 16.5 cm
502521	Dessert Knife Cuchillo de postre	7.1" / 18.1 cm
502522	Butter Spreader Pala para servir mantequilla	6.3" / 15.9 cm
502523	Teaspoon** Cuchara de té**	6.4" / 16.2 cm
502525	Demi Tasse Spoon Cucharita de café	4.9" / 12.4 cm

Satin finished handles. Knives 13/0. 2.5 mm* Pulido espejo con mango con acabado satinado Cuchillos 13/0. 2.5 mm*

ITEM #	DES	DIM
502702	Oval Dessert Spoon Cuchara de postre oval	7.4" / 18.7 cm
502703	Dinner Fork Tenedor de mesa	7.8" / 19.7 cm
502710	Salad Fork** Tenedor para ensalada**	6.3" / 15.8 cm
502711S	Dinner Knife Serrated, 65 gr** Cuchillo de mesa dentado, 65 gr**	8.8" / 22.2 cm
502713	Round Soup Spoon Cuchara redonda de sopa	7" / 17.8 cm
502714	Iced Tea Spoon Cuchara para té helado	7.8" / 19.7 cm
502715	Oyster Fork Tenedor para ostras	5.5" / 14 cm
502723	Teaspoon Cuchara de té	6" / 15.2 cm

**Represent 5 pieces place settings | **Représente le couvert de 5 pièces
*Thickness refers to dinner fork | *El grosor se refiere al tenedor de mesa.



ROYAL

18/0 STAINLESS STEEL. MIRROR FINISH.
ACERO INOXIDABLE 18/0. PULIDO ESPEJO.

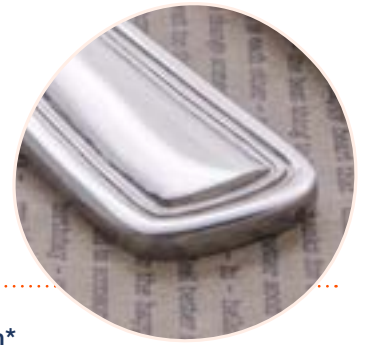

Knives 13/0. 2.2 mm* Cuchillos 13/0. 2.2 mm*

ITEM #	DES	DIM
502602	Dessert Spoon** Cuchara de postre**	7.1" / 18.1 cm
502603	Dinner Fork** Tenedor de mesa**	7.4" / 18.7 cm
502604	Tablespoon Cuchara de mesa	8" / 20.3 cm
502610	Salad Fork** Tenedor para ensalada**	6" / 15.2 cm
502611S	Dinner Knife Serrated, 65 gr** Cuchillo de mesa dentado, 65 gr**	8.7" / 21.9 cm
502613	Round Soup Spoon Cuchara redonda de sopa	6.9" / 17.5 cm
502614	Iced Tea Spoon Cuchara para té helado	7.9" / 20 cm
502615	Oyster Fork Tenedor para o	5.7" / 14.3 cm
502617	Bouillon Spoon Cuchara para consomé	5.8" / 14.5 cm
502622	Butter Spreader Bent Pala para servir mantequilla, curvada	6.8" / 17.1 cm
502623	Teaspoon** Cuchara de té**	5.7" / 14.3 cm
502625	Demi Tasse Spoon Cucharita de café	4.9" / 12.4 cm

**Represent 5 pieces place settings |

**Juego de 5 piezas



WIN2

18/0 STAINLESS STEEL. MIRROR FINISH.
ACERO INOXIDABLE 18/0. PULIDO ESPEJO.



Knives 13/0. 2 mm* Cuchillos 13/0. 2 mm*

ITEM #	DES	DIM
503802	Dessert Spoon** Cuchara de postre**	7.5" / 17 cm
503803	Dinner Fork** Tenedor de mesa**	7.5" / 17 cm
503810	Salad Fork** Tenedor para ensalada**	6.5" / 16.5 cm
503811S	Dinner Knife Serrated, 63 gr** Cuchillo de mesa dentado, 63 gr**	8.5" / 21.6 cm
503813	Round Soup Spoon Cuchara redonda de sopa	7.3" / 18.4 cm
503817	Bouillon Spoon Cuchara para consomé	6" / 15.2 cm
503823	Teaspoon** Cuchara de té**	6.3" / 15.8 cm

**Represent 5 pieces place settings |

**Juego de 5 piezas

*Thickness refers to dinner fork | *El grosor se refiere al tenedor de mesa.



WINDSOR

18/0 STAINLESS STEEL. MIRROR FINISH.
ACERO INOXIDABLE 18/0. PULIDO ACABADO.



DOMINION

18/0 STAINLESS STEEL. VIBRO FINISH.
ACERO INOXIDABLE 18/0. VIBRO ESPEJO.



*Thickness refers to dinner fork | *El grosor se refiere al tenedor de mesa.



Knives 13/0. 1.5 mm* Cuchillos 13/0. 1.5 mm*

ITEM #	DES	DIM
502802	Dessert Spoon** Cuchara de postren**	7.4" / 18.7 cm
502803	Dinner Fork** Tenedor de mesa**	7.3" / 18.4 cm
502804	Tablespoon Cuchara de mesa	7.8" / 19.7 cm
502810	Salad Fork** Tenedor para ensalada**	6.3" / 15.8 cm
502811	Dinner Knife, 42 gr** Cuchillo de mesa, 42 gr**	8.1" / 20.6 cm
502811S	Dinner Knife Serrated, 55 gr** Cuchillo de mesa dentado, 55 gr**	8.3" / 21 cm
502813	Round Soup Spoon Cuchara redonda de sopa	6.5" / 16.5 cm
502814	Iced Tea Spoon Cuchara para té helado	7.7" / 19.3 cm
502815	Oyster Fork Tenedor para ostras	5.8" / 14.6 cm
502817	Bouillon Spoon Cuchara para consomé	6" / 15.2 cm
502823	Teaspoon** Cuchara de té**	5.9" / 14.9 cm
502825	Demi Tasse Spoon Cucharita de café	4.7" / 11.7 cm
574352	Snail Fork Tenedor para escargot	6.5" / 16.5 cm

**Represent 5 pieces place settings |
**Juego de 5 piezas



Knives 13/0. 1.5 mm* Cuchillos 13/0. 1.5 mm*

ITEM #	DES	DIM
5500W	Dinner Knife Serrated, 42 gr**† Cuchillo de mesa dentado, 42 gr** †	8.3" / 20.9 cm
5502	Teaspoon** Cuchara de té**	6" / 15.2 cm
5503	Dinner Fork** Tenedor de mesa**	7.4" / 19.7 cm
5504	Dessert Spoon** Cuchara de postre**	7.1" / 18 cm
5506	Iced Tea Spoon Cuchara para té helado	8.8" / 22.2 cm
5508	Salad Fork** Tenedor para ensalada**	6.3" / 15.8 cm
5509	Bouillon Spoon Cuchara para consomé	5.8" / 14.6 cm

**Represent 5 pieces place settings | **Juego de 5 piezas

† Mirror finish | † Pulido acabado



KNIFE PROGRAM

EFFICIENT. AFFORDABLE.
THE IDEAL TOOL FOR SLICING
THROUGH STEAKS AND CHOPS.

PROGRAMA DE CUCHILLOS

EFICIENTES Y ASEQUIBLES, ESTOS
CUCHILLOS DE CARNE SON
LA HERRAMIENTA IDEAL PARA
CORTAR FILETES Y CHULETAS.



PAKKAWOOD

Ridgeline
Rounded Blade

Ridgeline
Cuchilla redondeada

ITEM # DIM
574338 9" / 23 cm

Idaho¹
Rounded Blade

Idaho¹
Cuchilla redondeada

ITEM # DIM
574340 10" / 25.5 cm

Wave
Pointed Blade

Wave
Cuchilla puntiaguda

ITEM # DIM
574339 9" / 23 cm

Vista¹
Pointed Blade

Vista¹
Cuchilla puntiaguda

ITEM # DIM
574341 10" / 25.5 cm

¹With full tang construction
¹Construcción de espiga llena



STAINLESS STEEL

ACERO INOXIDABLE



Contre-Filet Steak Knife
Satin finish handle with mirror polish bolster. Hollow handle. Serrated. Pointed blade.

Contre-Filet
Mango de acabado satinado con refuerzo de pulido espejo. Mango hueco. Serrado. Cuchilla puntiaguda.

ITEM # DIM
574343 9.75" / 25 cm



Tournedo Steak Knife
Satin finish handle with mirror polish bolster. Hollow handle. Serrated. Pointed blade.

Tournedo
Mango de acabado satinado con refuerzo de pulido espejo. Mango hueco. Serrado. Cuchilla puntiaguda.

ITEM # DIM
574344 9.5" / 24 cm



Choice Cut Steak Knife
Hollow handle and pointed blade. Satin finish.

Choice Cut
Mango hueco con acabado satinado.

ITEM # DIM
574332 9" / 23 cm



Chateaubriand Steak Knife
Hollow handle and pointed blade. Satin finish.

Chateaubriand
Mango hueco con acabado satinado.

ITEM # DIM
574333 10" / 25.5 cm

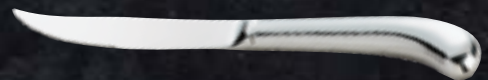

Delmonico Steak Knife
Hollow handle construction. Mirror finish.

Delmonico
Mango hueco con acabado espejo.

ITEM # DIM
574334 9" / 23 cm



POLYPROPYLENE

POLIPROPILENO



Eldorado

ITEM # DIM
574335 10" / 25.5 cm



Omaha

ITEM # DIM
574336 10" / 25.5 cm



New Line

ITEM # DIM
574330 9" / 23 cm



Carnival

ITEM # DIM
574329 8.8" / 22.5 cm



LOBSTER UTENSILS

UTENSILIOS DE LANGOSTA



746872

**Chrome Lobster Crack
Tenaza para langosta**

ITEM # DIM
746872 5.5" / 14 cm

746874 6" / 15.2 cm



**Stainless Steel Lobster Crack
Tenaza para langosta.
Acero inoxidable**

ITEM # DIM
746875 6" / 15.2 cm



**Stainless Steel Lobster Fork (Crab)
Tenedores para cangrejo.
Acero inoxidable**

ITEM # DIM
574031 8.5" / 21.5 cm



**Stainless Steel Lobster Fork
Tenedores para langosta.
Acero inoxidable**

ITEM # DIM
574032 6.5" / 16.5 cm



Foundation

NEW
NUEVO

FOUNDATION PORCELAIN DINNERWARE

PERFECTLY PLATED NO MATTER WHAT YOUR STYLE. PICK YOUR PIECE, SET YOUR FOUNDATION AND LET YOUR PERSONAL FOOD STYLING SHINE!

- Design driven with a wide range of styles and shapes that is ideal for many decors, from traditional to contemporary
- Large collection allows you to mix and match pieces for all your need
- High alumina composition and fired at a high temperature for strength and durability
- Great value porcelain designed to perform in foodservice environments

VAJILLA DE PORCELANA FOUNDATION

PERFECTAMENTE CHAPADO SIN IMPORTAR SU ESTILO. ¡ELIJA SU PIEZA, COLOQUE SU FOUNDATION Y DEJE QUE BRILLE SU ESTILO DE COMIDA PERSONAL!

- Impulsado por el diseño con una amplia gama de estilos y formas que es ideal para muchas decoraciones, desde tradicionales hasta contemporáneas
- Una gran colección le permite mezclar y combinar piezas para todas sus necesidades
- Alta composición de alúmina y cocción a alta temperatura para mayor resistencia y durabilidad
- Porcelana de gran valor diseñada para funcionar en entornos de servicio de alimentos





Bowl
Bol

ITEM #	CAP	DIM (WxH)
5630152	13.5 oz 400 ml	6" 15 cm



Bowl
Bol

ITEM #	CAP	DIM (WxH)
5630153	15.2 oz 450 ml	6" 15.3 cm



Bowl
Bol

ITEM #	CAP	DIM (WxH)
5630154	40.6 oz 1200 ml	9.25" 23.8 cm



Bowl
Bol

ITEM #	CAP	DIM (WxH)
5630155	6.8 oz 200 ml	4" 10.2 cm



Round Rimmed Bowl
Bol redondo con borde

ITEM #	CAP	DIM (WxH)
5630157	8.5 oz 250 ml	9.25" 23.5 cm



Bowl
Bol

ITEM #	CAP	DIM (WxH)
5630158	1.35 oz 40 ml	2.75" 7.3 cm



Stackable Bowl
Bol apilable

ITEM #	CAP	DIM (WxH)
5630150	7.1 oz 210 ml	4" 10.1 cm





Round Pizza Plate
Plato redondo para pizza

ITEM # DIM
5630169 12" / 30.5 cm



Round Coupe Plate
Plato coupé redondo

ITEM # DIM
5630162 6.5" / 16.2 cm
5630163 8" / 20.3 cm
5630166 10" / 25.4 cm
5630168 12" / 30.6 cm



Oval Coupe Plate
Plato coupé ovalado

ITEM # DIM
5630115 10 x 7.25"
25.3 x 18.4 cm
5630117 12 x 8"
30.6 x 20.6 cm



Rounded Square Coupe Plate
Plato coupé cuadrado redondeado

ITEM # DIM
5630195 6.75" / 17 cm
5630196 8.5" / 21.5 cm
5630197 10" / 25.3 cm
5630198 11.75" / 29.9 cm



Oval Plate
Plato ovalado

ITEM #	DIM	FITS POUR
5630170	13.25 x 7.5" 33.7 x 19.2 cm	5630102 5630155 5630158



Square Coupe Plate
Plato coupé cuadrado

ITEM # DIM
5630189 6.25" / 15.8 cm
5630190 8" / 20.5 cm
5630191 10.25" / 26.2 cm



Rectangle Coupe Plate
Plato coupé rectangular

ITEM # DIM
5630187 9.25 x 5.25
23.7 x 13.3 cm
5630188 12.3 x 8"
31.3 x 20.3 cm



5-Year Limited No-Chip Warranty

Browne offers a 5 year limited no-chip warranty on the Foundation collection.

Limitado a 5 años Garantía contra el astillamiento

Browne ofrece una garantía limitada contra el astillamiento de 5 años en la colección Foundation.



Rectangular Plates
Platos rectangulares

ITEM # DIM
5630186 12.75 x 9.5"
32.6 x 23.6 cm



Round Wide Rim Plate
Plato redondo de
borde ancho

ITEM # DIM
5630106 6.5" / 16.4 cm
5630108 9" / 22.7 cm
5630110 10.75" / 27.1 cm



Oval Wide Rim Plate
Plato ovalado de
borde ancho

ITEM # DIM (WxH)
5630118 11.75 x 8.5"
30.1x21.6 cm



Square Wide Rim Plate
Plato cuadrado de
borde ancho

ITEM # DIM
5630192 6" / 15.4 cm
5630193 10" / 25.4 cm
5630194 8.5" / 21.7 cm



Stackable Cup
Copa apilable

ITEM #	CAP	DIM (WxH)
5630178	7.8 oz 230 ml	4.25 x 3.25 x 2.75" 10.8 x 8.3 x 7 cm



Mug
Taza

ITEM #	CAP	DIM (WxH)
5630181	10.1 oz 300 ml	4.25 x 3 x 3.75" 11 x 7.9 x 9.4 cm



Saucer
Platillo

ITEM #	DIM	FITS POUR
5630173	6" / 15 cm	5630178 5630181



Creamer
Jarrita para leche

ITEM #	CAP	DIM (WxH)
5630120	5.4 oz 160 ml	2.75 x 2.75 x 3" 7 x 7 x 7.6 cm



Stackable Ramekin
Ramakin apilable

ITEM #	CAP	DIM (WxH)
5630102	2.37 oz 70 ml	2.5" 6.35 cm



Sugar Packet Holder
Soporte para
paquetes de azúcar

ITEM #	DIM (WxH)
5630101	4.25x3x1.75" 11 x 7.5 x 4.3 cm



Spoon
Cuchara

ITEM #	DIM
5630103	5.5 x 1.75 x 2" 13.8 x 4.7 x 4.9 cm



WOOD SERVING BOARD

BEAUTIFULLY DETAILED, IDEAL
FOR ENTRÉES, APPETIZERS,
SHARE PLATTERS & BUFFET USE

- Made with solid wood, creating variations in grain detailing, tone and sizing
- Sealed with a foodsafe protective mineral oil or varnish to enhance its appearance and to help prevent the absorption of water when washed



BANDEJA DE MADERA

HERMOSAMENTE DETALLADA,
ES IDEAL PARA ENTRADAS,
APERITIVOS, COMPARTIR
PLATOS Y BUFETS.

- *Nuestras tablas para servir de madera acacia están hechas de madera maciza, lo que crea variaciones en los detalles del grano, el tono y el tamaño*
- *Sellado con un barniz seguro para los alimentos para mejorar su apariencia y ayudar a prevenir la absorción de agua cuando se lava*





Hand Wash
Lavar a mano



Reversible
Reversible



Foodsafe
Apto para
alimentos

SMOOTH FINISH, WALNUT
STAIN, STAINLESS STEEL
HANDLES WITH PLATED SCREWS

- Flat surfaces for serving
- Stainless steel handle protects against rusting
- 4 plated screws secure handle attachment for durability

ACABADO LISO, COLOR NOGAL,
ASAS RECUBIERTAS EN ACERO
INOXIDABLE TORNILLOS
ENCHAPADOS

- Superficies planas para servir
- El asa de acero inoxidable protege contra el óxido
- 4 tornillos revestidos aseguran el aditamento del asa para su durabilidad

Acacia Wood Serving Board with Stainless Steel Handle

Sealed with a foodsafe protective varnish.

Bandeja de madera de acacia con tornillos plateados

Sellada con un barniz protector apto para alimentos

ITEM #	DES	DIM
571507	Rectangle, 3 Sections Rectángulo, tres secciones	12 x 7" 30.5 x 18 cm
571712	Round Redondas	12" 30.5 cm
571808	Rectangle Rectángulo	15 x 8.5" 38 x 21 cm

Our Acacia Wood serving boards are made with solid wood, creating variations in grain detailing and tone. These natural variances add to the beauty and uniqueness of each piece.

Nuestras tablas para servir de madera de acacia están hechas de una sola pieza de madera maciza, lo que crea variaciones en los detalles, el tono. Estas variaciones naturales se suman a la belleza y singularidad de cada pieza.



Acacia Wood Serving Board
One piece design. Sealed with a foodsafe protective varnish.

Tabla para servir

Diseño de una pieza. Scellé avec un vernis protecteur.

ITEM #	DIM**
57208	20 x 8" / 51 x 20 cm



**Acacia Wood Serving Board
with Handle**

One piece design. Sealed with a foodsafe protective varnish.

Tabla para servir con mango

Diseño de una pieza

ITEM #	DIM**
57128	12 x 8" / 30 x 20 cm
571610	16 x 10" / 41 x 25.4 cm

***Please note each item is made from solid wood, creating variations in grain detailing, tone and sizing. These natural variances add to the beauty and uniqueness to each piece. | Nuestras tablas para servir de madera de acacia están hechas de una sola pieza de madera maciza, lo que crea variaciones en los detalles, el tono. Estas variaciones naturales se suman a la belleza y singularidad de cada pieza.*



Maple wood cutting / carving board

Two-sided design for optimal usage:

- Includes juice channel for no-drip cutting and carving
- Flat serving face for cutting or serving

Tabla de cortar/ trinchar de madera de arce

Diseño de doble lado para un uso óptimo:

- Incluye canal de jugos para cortar y trinchar sin goteos
- Planas para cortar o servir

ITEM #	DIM
573616	16 x 12 x 1.5" / 40.64 x 30.48 x 3.81cm
573620	20 x 16 x 1.5" / 50.8 x 40.64 x 3.81 cm



Made in Canada
Hecho en Canadá



Knife Friendly
Apto para cuchillos



Reversible Acacia Wood Board with Inserts
Sealed with a foodsafe protective mineral oil. Includes inserts for use with a variety of serving dishes.

Tabla de madera para servir, reversible, con insertos

Incluye insertos para uso con una variedad de platos para servir.

ITEM #	DES	DIM
571267	1 Insert 1 inserto	11.8 x 6.7" / 30 x 17 cm
571643	3 Inserts 3 insertos	19 x 5.7" / 48.5 x 14.5 cm



Oval Shape Acacia Wood Board
Sealed with a foodsafe protective mineral oil.

Tabla de madera con forma ovalada

Scellé avec une huile minérale protectrice.

ITEM #	DIM
571260	12 x 6" / 30.5 x 15.2 cm
571680	16 x 8" / 40 x 20 cm



Compatible with our Mini Thermalloy® Cast Iron

Compatible con nuestra sartén de hierro fundido Mini Thermalloy®



CAST IRON

IDEAL FOR SERVING A RANGE OF DISHES AND SIDES FOR TABLE OR BUFFET SERVICE.

- Modern and traditional styles in a range of size and shapes
- Complete one piece design for strength and durability
- Heats evenly for superior browning, retains heat well for low temperature cooking and serving
- Pre-seasoned for a natural, easy-release finish that improves with use, PFOA/PTFE free

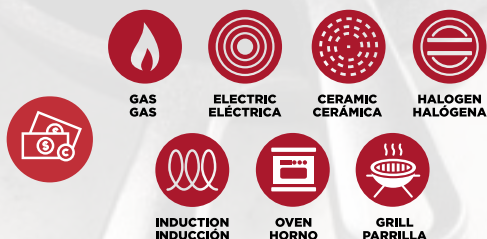

HIERRO FUNDIDO

IDEAL PARA SERVIR UNA VARIEDAD DE PLATOS Y ACOMPAÑAMIENTOS PARA LA MESA O EL SERVICIO DE BUFFET.

- Estilos moderno y tradicional en una diversidad de tamaños y formas
- Diseño completo de una sólo pieza para resistencia y durabilidad
- Calienta uniformemente para un dorado superior, retiene bien el calor para cocción a temperatura baja y servir a la mesa
- Previamente curado para un acabado natural y de fácil liberación que mejora con el uso, sin PFOA/PTFE



573757



573758



573759



ITEM #	CAP	FINISH
	5.3" / 13.5 cm; Round Redondas	
573757	9.5 oz / 280.9 ml	Pre-seasoned Pre-sazonado
	6" / 15.3 cm; Rectangle Rectángulares	
573758	10.5 oz / 310.5 ml	Pre-seasoned Pre-sazonado
	6.1" / 15.5 cm; Oval Ovaladas	
573759	11.5 oz / 340 ml	Pre-seasoned Pre-sazonado

573760



573761



573762



ITEM #	CAP	FINISH
	5.8" / 14.8 cm; Round Redondas	
573760	9.5 oz / 281 ml	Pre-seasoned Pre-sazonado
	6.9" / 17.6 cm; Oval Ovaladas	
573761	12.5 oz / 370 ml	Pre-seasoned Pre-sazonado
	6.6" / 16.6 cm; Round Redondas	
573762	16 oz / 473 ml	Pre-seasoned Pre-sazonado

573755



573756



ITEM #	CAP	FINISH
	5" / 12.7 cm; Oval Gratin Ovaladas, Gratén	
573755	11 oz / 325 ml	Pre-seasoned Pre-sazonado
	6" / 15.2 cm; Round Gratin Redondas, Gratén	
573756	12.25 oz / 362 ml	Pre-seasoned Pre-sazonado

CAST IRON SERVEWARE

UTENSILIOS PARA SERVIR DE HIERRO FUNDIDO



Cast Iron Skillet
Pre-seasoned. Fits 573723

Sartén de hierro fundido
Pre-sazonada. Para 573723.

ITEM #	DIMS OVERALL LARGO	DIMS INSIDE WELL DENTRO
573720	10.6 x 7.4 x 0.9" 27 x 18.8 x 2.2 cm	9.25 x 6.8 x 0.75" 23.5 x 17.3 x 1.9 cm



Cast Iron Skillet with Helper Handle
Pre-seasoned. Fits 573723.

Sartén de hierro fundido con mango
Pre-sazonada. Para 573723.

ITEM #	DIMS OVERALL LARGO	DIMS INSIDE WELL DENTRO
573722	14.5 x 7 x 0.9" 36.8 x 17.8 x 2.2 cm	9 x 6.6 x 0.5" 22.8 x 16.8 x 1.3 cm



**Onion Soup Bowl Set**

Ceramic. Set of 4 with Lids. Two-tone brown.

Juego de bols para sopa de cebolla

Cerámica. Juego de 4 con tapas.

ITEM #	CAP	DIM
744047	16 oz / 473 ml	3.5" / 8.9 cm

**Onion Soup Bowl**

Stoneware. White.

Bol para sopa de cebolla

Gres. Blanco.

ITEM #	CAP	DIM
744053W	16 oz / 473 ml	5 x 2.5" 12.7 x 6.4 cm

**Onion Soup Bowl**

Stoneware. White.

Bol para sopa de cebolla

Gres. Blanco.

ITEM #	CAP	DIM
744049W	12 oz / 355 ml	4.5 x 3" 11.4 cm x 7.2 cm

**Onion Soup Bowl**

Stoneware. With handle. Two-tone brown.

Bol para sopa de cebolla

Gres. Dos tonos de marrón.

ITEM #	CAP	DIM
744050	12 oz / 355 ml	4.5 x 3" 11.4 x 7.2 cm
744053BR	16 oz / 473 ml	5 x 2.5" 12.7 x 6.4 cm

**Café Au Lait Bowl**

Stoneware. White. Oven, microwave and dishwasher safe.

Bol para café con leche

Gres. Blanco. Se puede poner en el horno, microondas y lavavajillas.

ITEM #	CAP	DIM
564006	16 oz 473 ml	5.3 x 3" 13.4 x 7.2 cm

**Butter / Sauce Pot**

Stoneware. White.

Bol para mantequilla

Gres. Blanco.

ITEM #	CAP	DIM
564002W	2 oz 59 ml	2.3 x 1.3" 5.5 x 3 cm



564012W

White Lasagna Bakers

Smooth & ribbed.

Fuentes para lasaña blanco

Lisos y acanalado.



564011

ITEM #	CAP	DIM
Smooth Lisos		
564012W	12 oz / 355 ml	10 x 5.3 x 1.8" / 25.5 x 13.5 x 4.5 cm
564015W	16 oz / 473 ml	11 x 5.8 x 1.8" / 28 x 15 x 4.5 cm
Ribbed with smooth trim Acanalado con borde liso		
564011	8 oz / 236 ml	9.5 x 4.5 x 4.3" / 24 x 11 x 3 cm
564013	12 oz / 355 ml	9.8 x 5 x 1.8" / 25 x 13 x 4 cm
564014	16 oz / 473 ml	11.5 x 5.8 x 1.8" / 29 x 15 x 4 cm



564005W



564021W

Ramekins

Porcelain.

Ramekins

Porcelana.

ITEM #	CAP	DIM
Ribbed rim & sided Borde acanalado y desigual		
564005W	8 oz / 236 ml	4.5 x 1.8" / 13 x 4.5 cm
564021W	5 oz / 147 ml	3.5 x 1.5" / 9 x 4 cm
564024W	3 oz / 90 ml	3 x 1.5" / 8 x 4 cm
Smooth rim & Ribbed sides Borde liso y borde acanalado		
564022W	10 oz / 296 ml	4.3 x 2" / 11 x 5 cm
564003W	2.5 oz / 70 ml	2.8 x 1.5" / 7 x 4 cm



Round Au Gratin Dish

Porcelain. White.

Fuentes ovaladas para gratinar

Porcelana. Blanco.

ITEM #	CAP	DIM
564010W	10 oz 300 ml	6.5" 16.5 cm



Baking Shells

Porcelain.

Concha para hornear

Porcelana.

ITEM #	FINISH FINI	DIM
564008	Porcelain Porcelana	6" 15.2 cm



Oval Bakers

Stoneware.

Fuentes para horno, ovaladas

Gres.

ITEM #	COLOUR	CAP	DIM
564004BR	Brown Marrón	9 oz 266 ml	6 x 4 x 1.5" 16 x 10.5 x 3.8 cm
564004W	White Blanco	9 oz 266 ml	6 x 4 x 1.5" 16 x 10.5 x 3.8 cm



744042

6-Hole Escargot Plate with Handle

Stoneware.

Plato para caracoles

Gres.

ITEM #	COLOUR	DIM
744042	White Blanco	1.8 x 5.3" 4.5 x 13.4 cm
744045	Brown Marrón	1.8 x 5.3" 4.5 x 13.4 cm
744044	Honey Miel	1.5 x 5.3" 3.8 x 13.4 cm



Escargot Plate

Stoneware.

Plato para caracoles

Gres.

ITEM #	COLOUR	DIM
744046	Brown Marrón	1.5 x 5.3" 3.8 x 13.4 cm
744041	White Blanco	1.5 x 5.3" 3.8 x 13.4 cm



744045

SERVE / FRY CUPS

IDEAL FOR SERVING APPETIZERS, FRIES, ONION RINGS, SAUCES, DIPS & MORE

- Satin finish minimizes appearance of finger prints
- 18/8 Stainless Steel
- Stackable for storage
- Dishwasher safe



6 PACK | PIEZAS

ITEM # 515064



TAZA PARA SERVICIO / FRITURAS

IDEAL PARA SERVIR APERITIVOS, FRITURAS, AROS DE CEBOLLAS, SALSAS, DIPS Y MÁS

- El acabado satinado minimiza la aparición de las huellas dactilares
- Acero inoxidable 18/8
- Apilable para almacenamiento
- Aptas para el lavavajillas



ITEM #	CAP	DIM
515064	13.5 oz 400 ml	2.5 x 4.3" 6 x 11 cm



ITEM #	CAP	DIM
515062	13.5 oz 400 ml	2.75 x 4" 7 x 10 cm



ITEM #	CAP	DIM
515065	13.5 oz 400 ml	2.4 x 4.1" 6.2 x 10.5 cm





Stainless Steel Sauce Cup, pack of 12

Stainless steel. Mirror finish exterior. Satin finish interior. Plain rolled edge.

Bols para salsa, 12 piezas

Acero inoxidable. Exterior con acabado de espejo. Interior con acabado satinado. Bordes enrollados.

ITEM #	CAP	DIM
515058	1.5 oz / 44 ml	2.4" / 6 cm
515059	2.5 oz / 66 ml	2.4" / 6 cm
515057	4 oz / 118 ml	3.2" / 8.1 cm



515045

515047

515048

Mini Sauce Cups

18/8 Stainless Steel Mirror finish exterior. Satin finish interior. Stackable, unbreakable and reuseable. Dishwasher safe.

Mini platos para salsa

Acero inoxidable 18/8. Exterior con acabado de espejo. Interior con acabado satinado. Apilable, irrompible y reutilizable. Se puede lavar con seguridad en el lavaplatos.

ITEM #	CAP	DIM
515045	2 oz / 60ml	2.64 x 1.18" 6.7 x 3 cm
515047	2 oz / 60ml	2.56 x 0.98" 6.5 x 2.5 cm
515048	2 oz / 60ml	2.56 x 0.98" 6.5 x 2.5 cm

573706



Stainless Steel Gravy Boat

Mirror finish. Gadroon base.

Salsera

Acero inoxidable. Acabado espejo. Base con moldura acanalada..

ITEM #	CAP	DIM
515039	3 oz / 89 ml	6.3 x 3.3" 16 x 8.5 cm
515040	5 oz / 150 ml	3.6 x 2" 9.2 x 5.1 cm
515061	8 oz / 236 ml	9 x 4.3" 23 x 11 cm



Stainless Steel Egg Cup

Mirror finish.

Acero Inoxidable Huevera

Acabado espejo.

ITEM #	CAP	DIM
575063	4.5 ml / 1.5oz	2 x 1" 5 x 3 cm



515043



515044

Sherbet / Sundae Dish

Stainless steel. Mirror finish. Paneled top edge. Gadroon base.

Copas para sorbetes / sundae

Acero inoxidable. Acabado espejo. Borde superior en paneles. Base con moldura acanalada.

ITEM #	CAP	DIM
515043	3.5 oz / 104 ml	3.8" / 9.5 cm
515044	5 oz / 150 ml	4.3" / 10.8 cm

5811561



5811061



5811061

Aluminum Steak Platters and Dark Wood Underliner

Stamped aluminum. Mirror finish. To be used with dark wood underliners. Underliners made of kiln-dried hardwood.

Platos de bistec de aluminio y subrayado de madera oscura

Aluminio estampado. Acabado espejo. Para ser utilizado con revestimientos de madera oscura. Revestimientos de madera dura secada al horno.

ITEM #	FITS PARA	DIM	ITEM #	FITS PARA	DIM
Platter Fuentes			Underliner Bandeja		
5811561	5811061	7 x 10.5" 17.8 x 26.7 cm	5811061	5811561	8.3 x 12" 21.0 x 30.5 cm
5811562	5811062	8 x 11.5" 20.3 x 29.2 cm	5811062	5811562	8.3 x 12.5" 21.0 x 30.5 cm
5811563	5811063	8.3 x 12.5" 21.6 x 31.8 cm	5811063	5811563	9 x 13.5" 22.9 x 34.3 cm



Oval Platters

Mirror finish 18/0 stainless steel, with rolled edges. Surface safe for direct food contact. Dishwasher safe.

Fuentes ovaladas

Acero inoxidable 18/0 con acabado espejo y bordes enrollados. Superficie segura para el contacto directo con los alimentos. Apto para lavavajillas.

ITEM #	DIM
574180	10 x 7.3" / 26 x 18 cm
574181	11.5 x 8.5" / 29 x 21.6 cm
574182	14 x 9" / 35.6 x 22.9 cm
574183	16.3 x 10.7" / 41.3 x 27 cm
574184	19.5 x 13.5" / 49.5 x 34.3 cm
574185	22 x 15" / 55.9 x 38.1 cm
574186	26 x 18" / 66 x 45.7 cm



Oval Au Gratin Dish

Stainless steel. Mirror finish.

Fuentes ovaladas para gratinar

Inoxidable. Acabado espejo.

ITEM #	CAP	DIM
515030	8 oz 236 ml	8 x 4.5 x 5/8" 20.3 x 11.4 x 2.2 cm



Wood Serving Trivet Underliner

Protects tables from damage. Operating temperature up to 200°F / 93°C. Natural Finish.

Revestimiento de madera Trivet Underliner

Protege las mesas contra daños. Temperatura de funcionamiento hasta 200°F / 93°C. Acabado natural.

ITEM #	DIM	FITS PARA
573723	12.5 x 7.8" 31.8 x 19.7 cm	573720 573722



Bread Basket

Tan. Polypropylene. Have wire-reinforced tops, bottoms and ribs. Non-absorbent. Dishwasher safe.

Cestos de polipropileno

Polipropileno. Tostado. Tienen el borde superior, el fondo y las nervaduras reforzados con alambre. No absorbentes. Aptos para el lavavajillas.

ITEM #	DES	DIM
575443	Oval Ovalado	9 x 7 x 3" 22.9 x 17.8 x 7.6 cm
575444	Round Redondo	8 x 2.3" 20.3 x 5.7 cm



Ceramic Sugar Pack Holder Receptáculo de cerámica para sobres de azúcar

ITEM #	DIM
564001	4 x 2.8 x 2.8" 10.1 x 7 x 7 cm



Butter Warmer with Stoneware Pot Soporte cromado.

Calentador de mantequilla con pote de gres

ITEM #	CAP	DIM
575767	4 oz / 118 ml	3.5 x 4.3" 8.9 x 10.8 cm



Cuisipro.

SALT & PEPPER PUMP

- Sleek stainless steel mill and grinding mechanism
- One-handed operation
- Compact size for easy storage and portability
- Easy to use. Easy to refill

BOMBA DE SAL Y PIMIENTA

- Elegante molino de acero inoxidable y mecanismo de molienda
- Operación con una sola mano
- Tamaño compacto para un fácil almacenamiento y portabilidad
- Fácil de usar. Fácil de rellenar

Cuisipro Salt & Pepper Pump
Effortless. One-handed, one-touch pump.

Bomba de sal y pimienta Cuisipro
Fácil. Bomba de un solo toque, de un toque.

ITEM #	DIM
747869	5.9" / 15 cm



Cuisipro Salt & Pepper Grinder

Ceramic grinding mechanism. Choose from 4 preset grinding levels. Capacity: 65ml.

Molinillo de sal y pimienta Cuisipro
Mecanismo de molienda de cerámica. Elija entre 4 niveles de molienda preestablecidos. Capacidad: 65ml

ITEM #	DES	DIM
74783101	White Blanco	5.25" / 13.5 cm
74783105	Red Rojo	5.25" / 13.5 cm



Walnut Wood Pepper Mill

Forged steel mechanism. Walnut finish.

Molino para pimienta
Mecanismo de acero forjado. Acabado nogal.

ITEM #	DES	DIM
572121	Hardwood Madera dura	6" / 15 cm
572120	Wood Madera	12" / 30.5 cm



Top Glass Sugar Pourer

Self-closing centre spout with stainless steel top.

Azucarera de vidrio

Con pico a un lado que se cierra por sí solo con de acero inoxidable tapa

ITEM #	CAP	DIM
575186	12 oz / 355 ml	5.6" / 14.3 cm



Wire Skewers

Polished stainless steel with loop handle. Pointed tip.

Broqueta de alambre

Aceró inoxidable pulido con anillo que hace las veces de mango. Extremo puntiagudo.

ITEM #	DES	DIA
575692	Oval Ovalado	10" / 25.5 cm
575693	Oval Ovalado	12" / 30.5 cm
575691	Round Redondo	12" / 30.5 cm



Our Cash & Carry program is ideal for easy stocking and quick sales of everyday restaurant essential!



Nuestro programa Cash & Carry es ideal para un almacenamiento fácil y para ventas rápidas de utensilios de cocina esenciales para un restaurante cotidiano.



Squeeze Dispenser

High-quality, soft yet durable. Polyethylene dispensers. Will not crack or split. Features a no-drip tip design, eliminating messes.

Dispensadores estrujables

Dispensadores de polietileno. Durables, de alta calidad y blandos. No se resquebrajan o parten. Con un diseño a prueba de goteo para mayor higiene.

ITEM #	COLOR	CAP
1100	Red Rojo	8 oz / 236 ml
1101	Yellow Amarillo	8 oz / 236 ml
1102	Clear Transparente	8 oz / 236 ml
2101	Red Rojo	12 oz / 355 ml
2102	Yellow Amarillo	12 oz / 355 ml
2103	Clear Transparente	12 oz / 355 ml
2403	Clear Transparente	24 oz / 710 ml

6 pack | 6 piezas

ITEM #	COLOR	CAP
57800805	Red Rojo	8 oz / 236 ml
57800817	Yellow Amarillo	8 oz / 236 ml
57800800	Clear Transparente	8 oz / 236 ml
57801205	Red Rojo	12 oz / 355 ml
57801217	Yellow Amarillo	12 oz / 355 ml
57801200	Clear Transparente	12 oz / 355 ml

Wide Mouth Squeeze Dispenser

Wide mouth for quick and easy filling. Polyethylene dispensers. Durable, high-quality, soft. Will not crack or split. Non-drip tip design, eliminating mess.

Dispensadores estrujables de boca ancha, 6 piezas

Boca ancha para llenar rápida y fácilmente. Dispensadores de polietileno. Durables, de alta calidad y blandos. No se resquebrajan o parten. Con un diseño a prueba de goteo para mayor higiene.

ITEM #	COLOR	CAP
57801605	Red Rojo	16 oz / 473 ml
57801617	Yellow Amarillo	16 oz / 473 ml
57801600	Clear Transparente	16 oz / 473 ml
57802405	Red Rojo	24 oz / 710 ml
57802417	Yellow Amarillo	24 oz / 710 ml
57802400	Clear Transparente	24 oz / 710 ml
57803205	Red Rojo	32 oz / 946 ml
57803217	Yellow Amarillo	32 oz / 946 ml
57803200	Clear Transparente	32 oz / 946 ml

6 pack | 6 piezas

ITEM #	COLOR	CAP
57801705	Red Rojo	16 oz / 473 ml
57801717	Yellow Amarillo	16 oz / 473 ml
57801700	Clear Transparente	16 oz / 473 ml
57802505	Red Rojo	24 oz / 710 ml
57802517	Yellow Amarillo	24 oz / 710 ml
57802500	Clear Transparente	24 oz / 710 ml
57803305	Red Rojo	32 oz / 946 ml
57803317	Yellow Amarillo	32 oz / 946 ml
57803300	Clear Transparente	32 oz / 946 ml



4 pack | 4 piezas
ITEM # 575231

Plastic Sugar Pourer

Stainless steel top with self-closing side spout.

Azucarera de plástico

Tapa de acero inoxidable con pico a un lado que se cierra por sí solo.

ITEM #	CAP	DIM
575193	12 oz / 355 ml	5.6" / 14.3 cm



4 pack | 4 piezas
ITEM # 575228

Glass Sugar Pourer

Fluted glass. Stainless steel top with self-closing side spout.

Azucarera de vidrio

Vidrio estriado. Tapa de acero inoxidable con pico a un lado que se cierra por sí solo.

ITEM #	CAP	DIM
575187	12 oz / 355 ml	5.6" / 14.3 cm



6 pack | 6 piezas
ITEM # 575226

Glass Oil & Vinegar

Stainless steel pouring top.

Dispensador de aceite y vinagre, de vidrio

Tapa con vertedor de acero inoxidable.

ITEM #	CAP	DIM (HXW)
571600	6 oz / 152 ml	6 x 2" 15.2 x 5.1 cm



4 pack | 4 piezas
ITEM # 575229

Glass Syrup Dispenser

Heavy glass. One-piece, heavy-duty. Chrome plated metal top and handle. Stainless slide with rubber gasket.

Dispensador de jarabe

Vidrio grueso. Una pieza. Muy resistente, tapa y mango de metal cromado. Tapa corrediza inoxidable con arandela de goma.

ITEM #	CAP	DIM
575190	14 oz / 414 ml	6 x 3.5" 15.2 x 8.9 cm



575185

575181

4 pack | 4 piezas

ITEM # 575233 12 oz / 355 ml

ITEM # 575227 6 oz / 152 ml

Cheese Shaker

With stainless steel perforated top.

Dispensador para queso rallado

Plástico. Tapa de acero inoxidable.

ITEM #	DES	CAP	DIM (HXW)
575181	Plastic Plástico	12 oz 355 ml	5.6 x 3" 14.3 x 7.6 cm
575185	Glass Vidrio	6 oz 152 ml	3.6 x 2.6" 9.2 x 6.7 cm



12 pack | 12 piezas

ITEM # 575222

Salt & Pepper Shakers

Square glass. Stainless steel top with universal holes.

Salero y pimentero

Vidrio cuadrado con tapa de acero inoxidable con perforaciones universales.

ITEM #	CAP	DIM
575183	2 oz / 60 ml	4 x 1.5" 10.1 x 3.8 cm



12 pack | 12 piezas

ITEM # 575225

Mini Salt & Pepper Shakers

Classic square glass design. Chrome-plated, dome-shaped top with universal holes.

Mini salero y pimentero

Vidrio cuadrado con tapa cromada con perforaciones universales.

ITEM #	CAP	DIM
575191	0.5 oz / 15 ml	2 x 1.5" 5.1 x 3.8 cm



12 pack | 12 piezas

ITEM # 575224 1 oz / 29 ml

ITEM # 575232 2 oz / 59 ml

ITEM # 575223 3 oz / 89 ml

Salt & Pepper Shakers

Paneled Glass. Stainless steel mushroom shaped top with universal holes.

Saleros y pimenteros

Vidrio en paneles. Tapa de acero inoxidable con perforaciones universales.

ITEM #	CAP	DIM
571912	1 oz / 29 ml	3 x 1.6" 7.6 x 4.1 cm
571930	2 oz / 59 ml	3.6 x 2" 9.2 cm x 5.1 cm
571934	3 oz / 89 ml	4.6 x 2.1" 11.7 x 5.4 cm



12 pack | 12 piezas

ITEM # 575221

Tower Shaped Salt & Pepper Shakers

Classic tower glass design. Chrome-plated, dome-shaped top with universal holes.

Salero y pimentero

Vidrio, en forma de torre. Tapa cromada con perforaciones universales.

ITEM #	CAP	DIM
575182	1.02 oz / 30 ml	4.5 x 2" 11.4 x 5.1 cm



Teapot with Strainer
Tetera con colador

ITEM # CAP
515002 12 oz / 355 ml



Stainless Steel Economy Teapot
Tetera económica de acero inoxidable

ITEM # CAP DIM
515000 12 oz / 355 ml 4 x 4" / 10 x 10 cm



Stackable Teapot with Strainer
18/10 Stainless steel.

Tetera apilable
Acero inoxidable 18/10.

ITEM # CAP
515262 10 oz / 300 ml



Gooseneck Teapot

Stainless steel. Hinged lid. "Stay cool" hollow handle.

Tetera con cuello de cisne

Tapa con bisagra. Mango hueco que se mantiene frío.

ITEM # CAP DIM
515200 10 oz / 300 ml 6.5 x 3.5" / 16.5 x 9 cm



Stackable Teapot with Strainer
18/8 Stainless steel.

Teteras apilables
Acero inoxidable 18/8.

ITEM # CAP
515152 12 oz / 355 ml
515151 20 oz / 590 ml
515153 32 oz / 950 ml
515154 48 oz / 1.4 L





Porcelain Teapot With Strainer
White.

Teteras de cerámica
Blanco.

ITEM #	CAP	DIM
564023W	16 oz / 473 ml	6.4 x 4" 16.5 x 10.1 cm



Porcelain Teapot With Strainer
Tetera de porcelana

ITEM #	CAP	DIM
563933	16 oz / 473 ml	7.3 x 3" 19.7 x 7.2 cm



Coffee Decanter

Polished stainless steel with a plastic handle.

Garrafa de plástico para café

Acero inoxidable lustrado con mango de plástico.

ITEM #	CAP	DIM
515022	64 oz / 1.9 L	6.5" / 16.5 cm

Coffee Decanter

With stainless steel base. Lightweight and more resistant to breakage due to polysulfone construction.

Garrafa de plástico para café

Con base de acero inoxidable. Liviana y más resistente a roturas debido a su construcción con polisulfona.

ITEM #	CAP	DIM
515023	64 oz / 1.9 L	6.5" / 16.5 cm



Swirl Servers

Polyurethane foam insulation (average loss is only 0.188°F / minute over 4 hours). Comes with orange, brown and green tabs for easy identification.

Jarras aislantes roscadas

Aislante de espuma de poliuretano (la pérdida). Promedio es sólo de 0,188 °f/minuto durante 4 horas). Viene con pestañas en color naranja, marrón y verde para una fácil identificación.

ITEM #	COLOR	CAP	DIM
744220	White Blanco	20 oz / 0.6 L	7.5" / 19.1cm
744221	White Blanco	40 oz / 1.2 L	9.5" / 24.1 cm
744228	White Blanco	64 oz / 1.9 L	11.5" / 34 cm
744222	Black Negro	20 oz / 0.6 L	7.5" / 19.1cm
744223	Black Negro	40 oz / 1.2 L	9.5" / 24.1 cm



Swirl Lid only

Tapa solamente

ITEM #	COLOR	FITS
744220-1	White Blanco	744220
744221-1	White Blanco	744221
744228-1	White Blanco	744228
744222-1	Black Negro	744222
744223-1	Black Negro	744223

Swirl Insulated Servers

- High impact resistance. ABS Plastic outer body with thumb lever
- Unbreakable polycarbonate inner liner.
- Odorless and stain-resistant

Jarras Aislantes Roscadas

- Cuerpo exterior de plástico ABS con palanca accionada con el pulgar
- Revestimiento interior de policarbonato irrompible
- Inodoro y resistente a las manchas

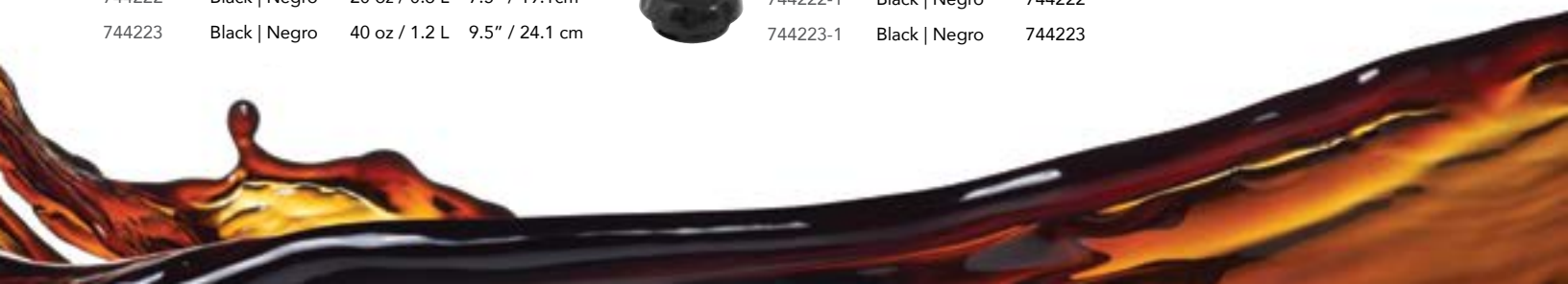
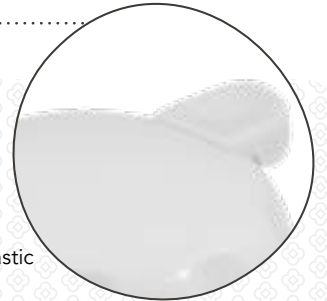



Ceramic Creamer
Cremera de cerámica

ITEM #	CAP	DIM
563930	6 oz / 166 ml	4 x 3.3" 10.1 x 9.5 cm



Stackable Teapot Creamer
Stainless steel. With flat recessed top for easy stacking.

Económica tetera / lechera apilable
Acero inoxidable 18/8. Con tapa plana rebajada para apilar más fácilmente

ITEM #	CAP	HEIGHT
515202	10 oz / 300 ml	3.3" / 8.3 cm



Bell Shape Creamer
Stainless steel. Mirror Finish.

Cremeras con forma acampanada
Acero inoxidable. Pulido espejo.

ITEM #	CAP	DIM
515071	3 oz / 89 ml	2" / 5.1 cm
515072	5 oz / 150 ml	2.8" / 7 cm
515073	8 oz / 236 ml	3.1" / 7.9 cm



Stainless Steel Water Pitcher
Stainless steel with guard. Gadroon base.

Jarra de agua
Con guarda. Acero inoxidable. Base con moldura acanalada.

ITEM #	CAP	DIM
515080	64 oz / 1.9 L	9 x 5" 22.9 x 12.7 cm



Bellshaped Pitcher
Stainless steel with tubular handle. Mirror finish.

Jarras con forma acampanada
Acero inoxidable con mango tubular. Pulido espejo.

ITEM #	CAP	DIM
8202	68 oz / 2 L	8" / 20.3 cm
8203	100 oz / 2.9 L	9" / 22.9 cm
With guard.		
8202G	68 oz / 2 L	8" / 20.3 cm
8203G	100 oz / 2.9 L	9" / 22.9 cm



Milk Frother
Tapered spout for controlled pouring of liquid and foam. Stainless steel for even heat distribution when frothing. Widened bottom design to promote perfect frothing. Does not absorb odors. Large handle for comfortable and secure grip. Easy to clean and dishwasher safe.

Lechera
Punta cónica que facilita el vertido del líquido y de la espuma. Construida en Acero inoxidable para una distribución uniforme del calor a la hora de espumar. Base ancha para una mejor formación de la espuma. No absorbe olores. Asa amplia para un agarre más cómodo y seguro. Fácil de limpiar y apta para el lavavajillas.

ITEM #	CAP	DIM
515007	12 oz / 355 ml	4.5 x 3.35" / 11.4 x 8.5 cm
515009	20 oz / 591 ml	5 x 4.3" / 13 x 11 cm
515010	32 oz / 94.6 ml	5.7 x 5" / 14.5 x 13 cm
515012	48 oz / 1.4 L	6.5 x 6" / 16.5 x 15.3 cm



Water Jug
Tapered spout with ice catcher for controlled pouring.

Jarra de agua
Punta cónica con guarda para hielo que facilita el vertido controlado.

ITEM #	CAP	DIM
515070	70 oz / 2.1 LI	7.3 x 6.5" 18.5 x 16.5 cm





Stainless Steel Wine or Ice Bucket
Balde de acero inoxidable para vino

ITEM # DIM (H X D)
571525 6.3 x 6" / 16 x 15.2 cm



Stainless Steel Insulated Wine Cooler

18/10 stainless. Double walled construction.

Recipiente térmico para enfriar vino

Acero inoxidable 18/10. Doble cámara aislante.

ITEM # CAP DIM
57513 50 oz / 1.4 L 7.8 x 4.5"
19.7 x 12 cm

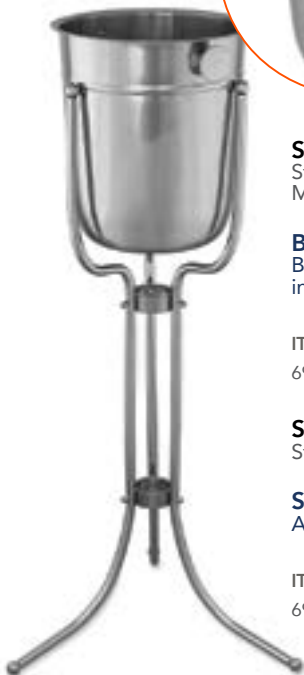

Stainless Steel Wine Bucket
Stainless steel with tubular handle. Mirror finish.

Balde para vino
Balde para vino de acero inoxidable.

ITEM # DIM
69501 9.5 x 8" / 24.1 x 22.2 cm

Stand for Wine Bucket
Stainless steel. Chrome-plated stand.

Soporte para balde de vino
Acero inoxidable. Soporte cromado.

ITEM # DIM
69502 30" / 76.2 cm



Stainless Steel Spring-Clip Menu / Card Holder

Stainless steel spring clip on a stamped base.

Porta menú / tarjeta

Clip con resorte de acero inoxidable sobre base estampada.

ITEM # DIM
57595 2.48" / 6.3 cm



Nickel-Plated Menu / Card Holder

Tightly wound spring wire welded to steel base.

Porta menú / tarjeta

Resorte de alambre resistente niquelado sobre base pesada.

ITEM # DIM
57596 2.19" / 5.56 cm
574107 2.17" / 5.5 cm



574107



Modern-Type Menu/Card Holder

Chrome-plated clip on weighted base.

Porta menú / tarjeta

Clip cromado sobre base pesada.

ITEM # DIM
4125 1.1" / 2.9 cm

4125

Chrome-Plated Menu & Card Holder

Tightly wound spring wire. Chrome-plated steel stand.

Porta menú y tarjeta

Resorte de alambre, enroscado muy apretado. Soporte de acero cromado.

ITEM # DIM
4145 12" / 30.5 cm
4155 15" / 38.1 cm
4165 18" / 45.7 cm

4145



Call Bells

Durable nickel-plated bell with metal base. Loud ring.

Timbres de llamada

Durable, niquelado, con base de metal y timbre fuerte.

ITEM # DIM
715 3" / 7.6 cm



Napkin Dispenser

Stainless steel. 150 napkin capacity.

Dispensadores de servilletas

Acero inoxidable. Capacidad: 150.

ITEM # DIM
57221 4 x 4.5 x 7.5"
10.2 x 11.4 x 19.1 cm

For standard napkins | Para servilleta estándar (3.5 x 7" / 8.9 x 17.8 cm)





Tall Wood Folding Tray Stand

Durable hardwood stand with mahogany finish. Includes rubber rings that provide slip-proof stability.

Soportes para bandeja plegables

Madera durable con acabado caoba. Tiene aros de goma para prevenir que la bandeja se deslice.

ITEM #	DIM
575694	17 x 16.3 x 32.5" 43.1 x 41.2 x 82.5 cm



Powder Coated Deluxe Tray Stand
With double bar and 3 straps.

Soporte plegable para bandeja, de lujo
Cromado. Con doble barra y 3 tiras.

ITEM #	DIM
575696	19.5 x 15 x 31.5" 49.5 x 39 x 80 cm



Wooden High-Chair

Stain-resistant finish. Wide stance to prevent tipping. Has safety restraint belt. Unassembled.

Sillas altas de madera

Acabado resistente a las manchas. Estructura ancha para prevenir accidentes. Con cinturón de seguridad. Sin armar.

ITEM #	FINISH FINI	DIM
80973	Natural Naturel	27.3" 69.2 cm

COMPLIANT WITH ASTM F404-18 SAFETY REQUIREMENTS
CUMPLE CON LOS REQUISITOS DE SEGURIDAD ASTM F404-18S

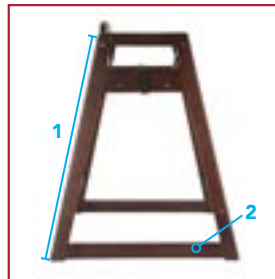

1. Increased leg dimension to 20.07 x 22.24" (510 x 565 mm). Aumento de la dimensión de los soportes a 20.07 x 22.24" / 510 x 565 mm.

2. Changed the bottom bar of legs to increase stability | Cambio de la barra inferior de las piernas para aumentar la estabilidad.



3. Reduced distance from the back to the T-bar for added safety. Distancia reducida desde la parte posterior hasta la barra en T para mayor seguridad.



4. Narrowed the side opening (below child's arm) | Se estrechó la abertura lateral (debajo del brazo del niño).

5. Enlarged the width of the seat bar to reduce the gap, keeping children properly seated and increasing the overall sturdiness of the chair. | Se amplió el ancho de la barra del asiento para reducir el espacio, mantener a los niños sentados adecuadamente y aumentar la robustez general de la silla.



Wooden High-Chair

Stain-resistant finish. Wide stance to prevent tipping. Has safety restraint belt. Unassembled.

Sillas altas de madera

Acabado resistente a las manchas. Estructura ancha para prevenir accidentes. Con cinturón de seguridad. Sin armar.

ITEM #	FINISH FINI	DIM
80976	Walnut Nuez	27.3" 69.2 cm

Bar Service

Keep your bar running smoothly and profitably with Browne's extensive selection of quality bar supplies. From professional corkscrews to stainless cocktail shakers, our quality crafted bar supplies are designed to help make your bar service efficient and effective.

Servicio de Bar

Su bar funcionará provechosamente y como una seda con la amplísima selección de accesorios de calidad que Browne le ofrece. Desde sacacorchos profesionales hasta cocteleras inoxidable, nuestros productos de fabricación superior están diseñados para facilitar el servicio que usted y sus empleados brindan en el bar.





3 Piece Stainless Steel Cocktail Shaker

Satin finish inside. Complete with strainer and cover cup.

Coctelera, 3 piezas

Acero inoxidable. Completas con colador y tapa con forma de vacito.

ITEM #	CAP	DIM
57506	14.2 oz / 420 ml	4.8 x 3.8" 12.2 x 9.9 cm
57508	30 oz / 887 ml	10 x 3.5" 25.4 x 9.2 cm



3 Piece Stainless Steel Cocktail Shaker

Stainless steel. Satin finish inside.

Coctelera, 3 piezas

Acero inoxidable. Interior satinado.

ITEM #	CAP	DIM (HT X DIA)
57502	8 oz / 236 ml	6 x 2.7" 15.2 x 6.7 cm



Stainless Steel Cocktail Shaker

Stainless steel. Satin finish inside.
Fits a standard shaker glass.

Cocteleras

Acero inoxidable. Interior satinado.
Acomoda un vaso para mezclar.

ITEM #	CAP	DIM
57505	15 oz / 444 ml	4.5 x 3.4" 11.4 x 8.6 cm
57509	30 oz / 887 ml	7 x 3.7" 17.8 x 9.2 cm





Extended salt
rimmer when
fully opened

*Bandeja para
sal extendida
cuando se
abre total-
mente*



Side Accessories Compartment

Detachable side compartments for cocktail accessories such as straws, picks, stirrers, etc. Set of two (left & right).

Compartimiento separable para accesorios

Compartimiento separable a un lado para accesorios de cóctel, como pajitas o popotes, palillos para pinchar, agitadores para café, etc

ITEM #	DIM
574877	6 x 2.33 x 5.5" 15 x 6 x 14 cm

All-in-One Bar Caddy

Features 6 garnish compartments. Also available are a detachable "side" compartment for fruit condiments and a detachable compartment for cocktail accessories including straws, picks, stirrers and more.

Bandeja de condimentos

6 compartimientos para aderezos. También hay disponible un compartimiento separable "a un lado" para condimentos de frutas y un compartimiento separable para accesorios de cóctel, como pajitas o popotes, palillos para pinchar, agitadores para café, etc.

ITEM #	CAP	DIM
574875	500 ml / 1 pt	20 x 7 x 6" 51 x 18 x 15.5 cm



Side Condiment Compartment

Detachable condiment holder.

Compartimiento separable de condimentos

Compartimiento separable para condimentos.

ITEM #	CAP	DIM
574876	2L / 2 pints	7.75 x 7 x 6" 20 x 18 x 15.5 cm



6 Compartment Condiment Holder

Includes six durable plastic, semi-opaque 500 ml / 1 pint inserts that sit on top of a well of ice keeping all condiments in one conveniently chilled location. Also features a clear lid for easy identification as well as to protect condiments when not in use. Sealed bottom to prevent leakage.

Portacondimentos de 6 compartimientos

Incluye seis compartimientos de una pinta (500ml) de capacidad, en plástico duradero y semiopaco que se asientan sobre un receptáculo de hielo que mantiene todos los condimentos en un lugar convenientemente refrigerado. También cuenta con una tapa transparente para una fácil identificación y proteger los condimentos cuando no está en uso. Fondo sellado para evitar derrames.

ITEM #	COLOR	DIM
57483802	Black Negro	20 x 5.1 x 6.5" 50.5 x 13 x 16.5 cm



Bar Caddy Condiment Tray

Seamless plastic tray with cover. Odorless. Noiseless. 4 compartments: 4 x 4 x 2.8" / 10.2 x 10.2 x 7 cm.

Organizador / Bandeja de condimentos

Bandeja de plástico sin costura. Sin olor. Silenciosa. 4 compartimentos 4 x 4 x 2 3/4 pulg. / 10.2 x 10.2 x 7 cm.

ITEM #	CAP	DIM
574837	600 ml / 1.25 pt	18 x 5 x 3" 45.7 x 12.7 x 7.6 cm



Stainless Steel Bar Caddy Condiment Tray with Clear Plastic Lid Con tapa de plástico transparente

ITEM #	DES	DIM
79300†	Four 500 ml / 1 pint plastic inserts Cuatro insertos de plástico de 500 ml / 1 pinta	11.9 x 5.5 x 3.5" 30.2 x 14 x 8.9 cm
79302†	Five 500 ml / 1 pint plastic inserts Cuatro insertos de plástico de 500 ml / 1 pinta	14.8 x 5.5 x 3.5" 37.5 x 14 x 8.9 cm
79303†	Six 500 ml / 1 pint plastic inserts Cuatro insertos de plástico de 500 ml / 1 pinta	17.8 x 5.5 x 3.5" 45.1 x 14 x 8.9 cm

†Inserts are not sold separately
Los insertos no se venden por separado



Professional Glass Rimmer

Three (3) individual tiers for lime juice, salt, and sugar. Includes juice sponge; replacement available. Fits glasses up to 5.5" / 14 cm diameter.

Escarchador de copas profesional

3 niveles individuales para jugo de limón / lima, sal y azúcar. Excelente para preparar Margaritas, Bloody Marys y otros cócteles escarchados con sal o azúcar. Incluye esponja para jugo; repuesto disponible. Para copas de hasta 14 cm (5.5 pulg.) de diámetro.

ITEM #	DIM
574834	7.8 x 6.3" / 18.5 x 16 cm

PARTS
PARTIES

DES	ITEM #
Sponge Esponja	574834S



Malt Cup

Stainless steel graduated cup. Satin finish inside. Reinforced bottom. Fits all standard machines.

Vaso para malta

Vaso graduado de acero inoxidable. Interior satinado. Fondo reforzado. Apto para todas las máquinas estándar.

ITEM #	CAP	DIM (HT X DIA)
57510	30 oz 887 ml	7 x 4" 18 x 10.2 cm



Stainless Steel Fruit Muddler

A durable, one-piece satin finish stainless steel fruit muddler features non-slip grip rings on handle to provide a comfortable grip. Note the sharp serrated base designed for efficiency.

Agitador de Acero Inoxidable

Durable, construido de una pieza en acero inoxidable con acabado satinado. Mango de diseño antirresbalante que proporciona un agarre firme y cómodo. Base serrada y filosa, para mayor eficiencia.

ITEM #	DIM
747091	8.5 x 1" 21.6 x 2.5 cm



Professional Lemon / Lime Squeezer

Made of heavy, stainless steel. Closed Jaw.

Exprimidor profesional de limón / lima

Acero inoxidable resistente.

ITEM #	DIM
57520	6.1" / 15.6 cm



Bar Strainer

Stainless steel body and spring. Four (4) ears.

Colador para bar

Cuerpo y resorte de acero inoxidable.

ITEM #	DIM
57507	6" / 15.2 cm



Malt Cup with Handle

Stainless steel graduated cup. Satin finish inside. Reinforced bottom. Fits all standard machines.

Vaso para malta con mango

Vaso graduado de acero inoxidable. Interior satinado. Fondo reforzado. Apto para todas las máquinas estándar.

ITEM #	CAP	DIM (HT X DIA)
57512	30 oz 887 ml	7 x 4" 18 x 10.2 cm



ABS Muddler

Sharp serrated base for efficiency. One-piece black ABS construction.

Agitador de ABS

Diseñado para "revolver" o mezclar ingredientes de cóctel, particularmente mojitos. Base serrada y filosa, para mayor eficiencia. Construido de una pieza de ABS negro.

ITEM #	DIM
57514	8.25 x 1" 21 x 2.5 cm



Stainless Bar Spoon

Stainless steel. One-piece construction. Twisted shaft for easy stirring.

Cuchara inoxidable para bar

Acero inoxidable. Construcción de una sola pieza. Tallo retorcido para revolver mejor.

ITEM #	DIM
57501	11" / 27.9 cm



Muddler

Hardwood construction. Professional quality.

Agitador

Construcción de madera dura. Calidad profesional.

ITEM #	DIM
571515	8 x 20.3 cm



Zester Channel / Knife
Hardwood handle. Stainless steel blade.

Zester Channel / Cuchillo
Mango de madera. Cuchilla de acero inoxidable.

ITEM # DIM
573841 6" / 15 cm



Ice Chipper
Carbon steel blade. (4.5" / 11.4 cm).
Hardwood handle.

Punzón para romper hielo
Punzón para romper hielo Cuchilla de acero al carbono (4.5 pulg. / 11.4 cm).
Mango de madera dura.

ITEM # DIM
57521 7.5" / 19.1 cm



Six-point Ice Chipper
Heavy-duty carbon steel points.
Hardwood handle.

Granizador de hielo de seis puntas
Puntas de acero al carbono muy resistente. Mango de madera dura.

ITEM # DIM
746740 9" / 22.9 cm



Stainless Steel Chicken Feet Tongs
Ideal for use with ice, cakes or pastries. 0.8 mm thickness.

Pinzas inoxidables con tenazillas
Ideal para usar con hielo, pasteles o repostería. 1.0 mm de espesor.

ITEM # DIM
57526 6.5" / 16.5 cm



Stainless Steel Ice Scoop
Tapered shaped perfect for scooping ice into glass. Handle is welded to bowl. Wide scoop.

Pala inoxidable para servir hielo
Acero inoxidable. Con forma cónica, perfecta para servir hielo en el vaso. El mango está soldado al bol de la pala.

ITEM #	CAP	DIA (BOWL)	DIM
574214	3.3 oz / 97.6 ml	3" / 7.6 cm	9.5" / 24.1 cm



Stainless Steel Scalloped Claw Tongs
Ideal for use with ice, cakes or pastries. 1.0 mm thickness.

Pinzas inoxidables con tenazillas
Ideal para usar con hielo, pasteles o repostería. 1.0 mm de espesor.

ITEM # DIM
57525 7.3" / 18.4 cm



Aluminum Ice Scoop
Die-cast aluminum. One piece with a polish finish.

Pala de aluminio para servir hielo
Aluminio fundido. Una sola pieza con acabado pulido.

ITEM #	CAP	DIA	DIM
123	4 oz / 118.3 ml	2.5" / 6.3 cm	9" / 22.8 cm



Double Hinged Professional Corkscrew
Patented ergonomic handle design. Perfect long lever uncorking grip; patented 1-step opening including spiral, pull out knife made from ABS and stainless steel. Built in bottle opener.

Sacacorchos profesional
Mango ergonómico patentado. Perfecto agarre de palanca larga descorche; Abertura patentada de 1 paso que incluye espiral, cuchillo extraíble hecho de ABS y acero inoxidable. Construido en abrebotellas.

ITEM #	DIM
574075	4.5" / 11.4 cm



Single Hinged Corkscrew
Plastic handle. Hardened steel worm. Black.

Sacacorchos de una sola bisagra.
Mango de plástico. Espiral de acero endurecido. Negro.

ITEM #	DIM
574077BK	4.5" / 11.4 cm



Waiter's Corkscrew
Sacacorchos "de camarero"

ITEM #	DES	DIM
1147K	Nickel-plated Niquelado.	4.5" / 11.4 cm
574076	Chrome Cromado.	4.5" / 11.4 cm



Wing Corkscrew
Chrome. Heavy Duty.

Sacacorchos profesional de aleta
Cromado.

ITEM #	DIM
574081	8.5" / 21.6 cm



Wing Corkscrew
Chrome/Black. Heavy Duty.

Sacacorchos profesional de aleta
Cromado.

ITEM #	DIM
574082	8.5" / 21.6 cm



Chrome Corkscrew
Die cast, chrome plated. Geared lever.

Sacacorchos de cromo
Fundido a presión, cromado. Palanca con engranajes.

ITEM #	DIM
744071	6" / 15 cm



Can Punch & Bottle Opener
Nickel plated.

Abrebotellas y punzón para latas
Niquelado.

ITEM #	DIM
574078	4" / 10.2 cm



Bottle Opener
Extra-thick stainless steel. Convenient, flat shape.

Abrebotellas
Acero inoxidable extra grueso. Conveniente forma plana.

ITEM #	DIM
574074	7" / 17.8 cm



Giant Opener
Heavy gauge nickel-plated, stamped steel.

Abridor / punzón, gigante
Acero estampado niquelado muy resistente

ITEM #	DIM
574079	7" / 17.8 cm



Wall Mount Bottle Cap Remover
Cast metal. Mounting screws included. Cadmium plated.

Destapador de pared
Metal fundido. Tornillos para instalar incluidos. Enchapado en cadmio.

ITEM #	DIM
1199	3.19 x 2.63 x 1.13" / 8.10 x 6.68 x 2.87 cm

Reduce spillage with Free Flow Pourers

Reduce spillage with a professional look. These pourers feature a free flow design that will simplify bar service while reducing the amount of product spillage, thus reducing expenses.

Reduzca los derrames con un tapón vertedor

Reduzca los derrames con un aspecto profesional. Estos tapones cuentan con un diseño de flujo libre que simplificará el servicio de bar mientras reduce la cantidad de derrames de productos, lo que reduce los gastos.



Stainless Steel Double Jiggers

Satin Interior.

Vasitos medidores dobles de acero inoxidable

Interior satinado.

ITEM #	CAP	ITEM #	CAP
1290	0.5 oz - 1 oz 15 ml - 29 ml	1293	1 oz - 2 oz 29 ml - 66 ml
1291	0.75 oz - 1.5 oz 22 ml - 44ml	1294	0.75 oz - 1.25 oz 22 ml - 37 ml
1292	1 oz - 1.5 oz 29 ml - 44 ml	1295	1 oz - 1.25 oz 29 ml - 37 ml

Liquor Pourer

Tapered spout. Stainless steel nozzle with plastic cork.

Tapón vertedor de licores

Boquilla de acero inoxidable con tapón de plástico.

ITEM #
78767

Chrome Plated Pourers

Tapón Vertedor

ITEM #
57405720

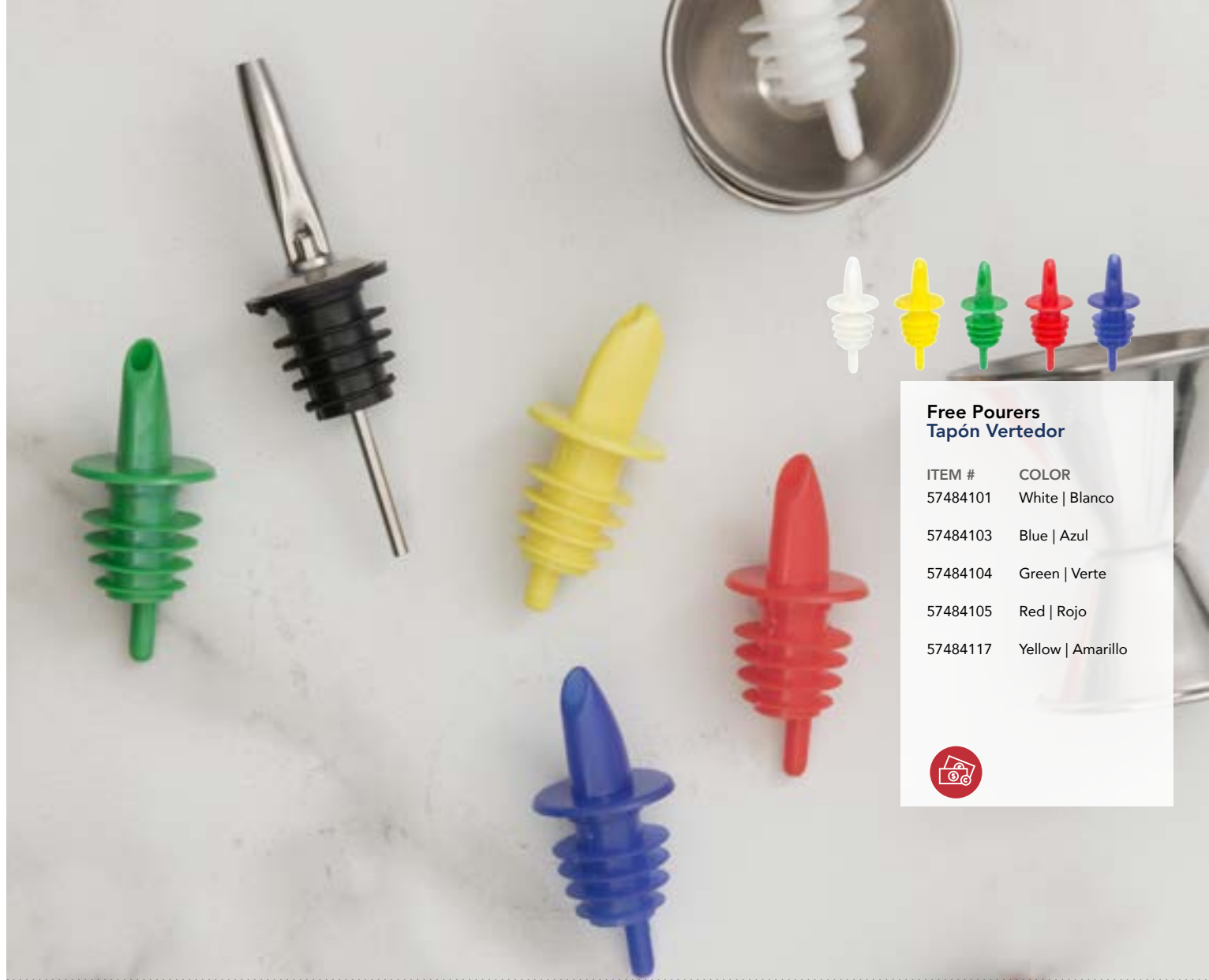

**Free Pourers
Tapón Vertedor**

ITEM #	COLOR
57484101	White Blanco
57484103	Blue Azul
57484104	Green Verde
57484105	Red Rojo
57484117	Yellow Amarillo



Bar Drainer / Mat
Soft rubber mat with well at both ends. Brown.

Escurreidor/esterilla para el bar
Suave esterilla de goma con cavidad en ambos extremos. Marrón.

ITEM #	COLOR	DIM
57486812	Brown Marrón	3.3 x 27" / 8.8 x 68.6 cm



Bar Drainer / Mat
Thick, heavy rubber that grips wet glassware (with well at one end) in order to prevent spills and to protect the bar's surface. Soft rubber mat.

Escurreidor/esterilla para el bar
Las esterillas para el bar Browne tienen una goma gruesa y gruesa que se agarra a la cristalería húmeda (con una cavidad en un extremo) para evitar derrames y proteger la superficie de la barra. Esterilla de goma suave.

ITEM #	COLOR	DIM
57486602	Black Negro	24 x 3" / 61 x 7.6 cm
57486612	Brown Marrón	24 x 3" / 61 x 7.6 cm



Bar Mat
Thick, heavy rubber that grips wet glassware in order to prevent spills and to protect the bar's surface. Soft rubber mat.

Esterilla para el bar
Goma gruesa y pesada que se agarra a la cristalería húmeda para evitar derrames y proteger la superficie de la barra. Esterilla de goma suave.

ITEM #	COLOR	DIM
57486702	Black Negro	18 x 12" / 45.7 x 30.5 cm
57486712	Brown Marrón	18 x 12" / 45.7 x 30.5 cm



Kitchen Service

Browne provides a broad range of kitchenware to optimize preparation, cooking and clean-up. Our design and sourcing teams create innovation in design and construction to ensure any commercial kitchen runs smoothly, while focusing on performance, safety and efficiency.

Servicio de Cocina

Browne ofrece una amplia gama de utensilios de cocina para optimizar la preparación, la cocción y la limpieza. Nuestros equipos de diseño y abastecimiento crean innovación en el diseño y la construcción para garantizar que cualquier cocina comercial funcione sin problemas, mientras se enfoca en el rendimiento, la seguridad y la eficiencia.





ANTI-JAM STEAM PANS



REINFORCED EDGES & CORNERS RESIST BENDING. SPACE BETWEEN PAN CREATES VENTILATION, ALLOWING PANS TO DRY COMPLETELY FOR PROPER SANITATION..

Available in three different gauges:
22 / 0.8 mm; 24 / 0.6 mm or 25 / 0.5 mm.



HEAVY WEIGHT. 304 STAINLESS STEEL 22 GAUGE / 0.8 MM.
ACERO INOXIDABLE 304 CALIBRE 22 / 0.8 MM. ALTO VOLUMEN

ITEM #	DIM		DEPTH PROFUNDIDAD	CAP	SOLID COVER TAPA SÓLIDA	NOTCHED COVER TAPA CON HENDIDURAS	WIRE GRATE REJILLA	FALSE BOTTOM FONDO FALSO
22002	 1/1	$\frac{1}{4}$	2.5" / 6.4 cm	8.2 QT / 7.7 L				
22004		Full Completo 53 x 32.4 cm 20 $\frac{3}{4}$ x 12 $\frac{3}{4}$ "	4" / 10 cm	14.8 QT / 14 L	575528	575529	575527	5788010
22006			6" / 15.2 cm	21.2 QT / 20 L				
22232	 2/3	$\frac{2}{3}$	2.5" / 6.4 cm	6.3 QT / 5.9 L				
22234		Two-thirds Deux tiers 35.2 x 32.4 cm 13 $\frac{3}{8}$ x 12 $\frac{3}{4}$ "	4" / 10 cm	10.1 QT / 9.5 L	575578	575579	NA	NA
22236			6" / 15.2 cm	15.7 QT / 14.8 L				
22122	 1/2	$\frac{1}{2}$	2.5" / 6.4 cm	4.3 QT / 4 L				
22124		Half Mediano 26.4 x 32.4 cm 10 $\frac{3}{8}$ x 12 $\frac{3}{4}$ "	4" / 10 cm	7 QT / 6.6 L	575538	575539	575537	5788120
22126			6" / 15.2 cm	10.6 QT / 10 L				
22241L	 1/2 Long Mediano	$\frac{1}{2}$	1.3" / 3.2 cm	2.1 QT / 1.9 L				
22242		Half Long Mediano	2.5" / 6.4 cm	4 QT / 3.7 L	22240	NA	NA	NA
22244		53 x 16.2 cm 20 $\frac{3}{4}$ x 6 $\frac{7}{16}$ "	4" / 10 cm	6.3 QT / 5.9 L				
22246			6" / 15.2 cm	9.2 QT / 8.7 L				



FÁCIL DE SEPARAR



LOS BORDES Y ESQUINAS REFORZADOS RESISTENTES A TORCEDURAS. EL ESPACIO ENTRE LOS RECIPIENTES SIRVE DE VENTILACIÓN Y PERMITE QUE ÉSTOS SE SEQUEN. COMPLETAMENTE ASEGURANDO UNA DEBIDA HIGIENE.



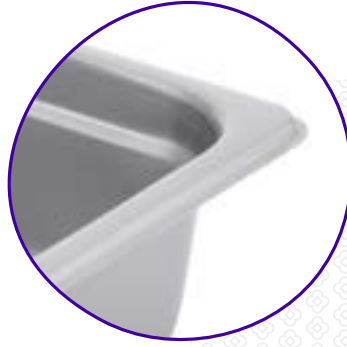

Disponible en tres diferentes calibres: 22 / 0.8 mm; 24 / 0.6 mm o 25 / 0.5 mm.





Anti-jam design covers full perimeter of pan, resulting in better performance.

El diseño fácil de separar cubre todo el perímetro de la bandeja, lo que resulta en un mejor rendimiento



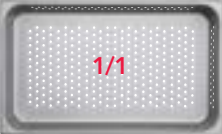



HEAVY WEIGHT. 304 STAINLESS STEEL 22 GAUGE / 0.8 MM. ACERO INOXIDABLE 304 CALIBRE 22 / 0.8 MM. ALTO VOLUMEN

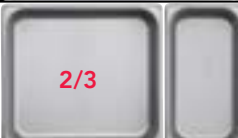

ITEM #	DIM	DEPTH PROFUNDIDAD	CAP	SOLID COVER TAPA SÓLIDA	NOTCHED COVER TAPA CON HENDIDURAS	WIRE GRATE REJILLA	FALSE BOTTOM FONDO FALSO
22132		2.5" / 6.4 cm	2.6 QT / 2.4 L				
22134		4" / 10 cm	4.5 QT / 4.2 L	575548	575549	PG510	NA
22136		6" / 15.2 cm	6.4 QT / 6 L				
22142		2.5" / 6.4 cm	2.2 QT / 2 L				
22144		4" / 10 cm	3.1 QT / 2.9 L	575558	575559	N/A	NA
22146		6" / 15.2 cm	4.6 QT / 4.3 L				
22162		2.5" / 6.4 cm	1.2 QT / 1.1 L				
22164		4" / 10 cm	2.1 QT / 1.9 L	575568	575569	NA	NA
22166		6" / 15.2 cm	2.8 QT / 2.6 L				
22192		2.5" / 6.4 cm	0.8 QT / 0.7 L				
22194		4" / 10 cm	1.1 QT / 1 L	575598	575599	NA	NA
22196		6" / 15.2 cm	1.5 QT / 1.4 L				

ITEM #	DIM	DEPTH PROFUNDIDAD	CAP	SOLID COVER TAPA SÓLIDA	NOTCHED COVER TAPA CON HENDIDURAS	WIRE GRATE REJILLA	FALSE BOTTOM FONDO FALSO
22112		2.5" / 6.4 cm	8.2 QT / 7.7 L				
22114		4" / 10 cm	14.8 QT / 14 L	575528	575529	575527	5788010
22116		6" / 15.2 cm	21.2 QT / 20 L				
21212		2.5" / 6.4 cm	4.3 QT / 4 L				
21214		4" / 10 cm	7 QT / 6.6 L	575538	575539	575537	5788120
21216		6" / 15.2 cm	10.6 QT / 10 L				





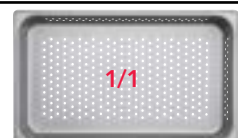

MEDIUM WEIGHT.  304 STAINLESS STEEL ANTI-JAM 24 GAUGE / 0.6 MM.
ACERO INOXIDABLE 304 CALIBRE 24 / 0.6 MM. VOLUMEN MEDIANO

ITEM #	DIM		DEPTH PROFUNDIDAD	CAP	SOLID COVER TAPA SÓL- IDA	NOTCHED COVER TAPA CON HENDIDU- RAS	WIRE GRATE REJILLA	FALSE BOTTOM FONDO FALSO
5781102		$\frac{1}{1}$ Full Completo 53 x 32.4 cm 20 $\frac{3}{4}$ x 12 $\frac{3}{4}$ "	2.5" / 6.4 cm	8.2 QT / 7.7 L				
5781104			4" / 10 cm	14.8 QT / 14 L	575528	575529	575527	5788010
5781106			6" / 15.2 cm	21.2 QT / 20 L				
88232		$\frac{2}{3}$ Two-thirds Deux tiers 35.2 x 32.4 cm 13 $\frac{7}{8}$ x 12 $\frac{3}{4}$ "	2.5" / 6.4 cm	6.3 QT / 5.9 L				
88234			4" / 10 cm	10.1 QT / 9.5 L	575578	575579	NA	NA
88236			6" / 15.2 cm	15.7 QT / 14.8 L				
5781202		$\frac{1}{2}$ Half Mediano 26.4 x 32.4 cm 10 $\frac{3}{8}$ x 12 $\frac{3}{4}$ "	2.5" / 6.4 cm	4.3 QT / 4 L				
5781204			4" / 10 cm	7 QT / 6.6 L	575538	575539	575537	5788120
5781206			6" / 15.2 cm	10.6 QT / 10 L				
5781302		$\frac{1}{3}$ One-Third Un tercio 17.5 x 32.4 cm 6 $\frac{7}{8}$ x 12 $\frac{3}{4}$ "	2.5" / 6.4 cm	2.6 QT / 2.4 L				
5781304			4" / 10 cm	4.5 QT / 4.2 L	575548	575549	PG510	NA
5781306			6" / 15.2 cm	6.4 QT / 6 L				
5781402		$\frac{1}{4}$ One-Fourth Un cuarto 26.4 x 16.2 cm 10 $\frac{3}{8}$ x 6 $\frac{3}{8}$ "	2.5" / 6.4 cm	2.2 QT / 2 L				
5781404			4" / 10 cm	3.1 QT / 2.9 L	575558	575559	NA	NA
5781406			6" / 15.2 cm	4.6 QT / 4.3 L				
5781602		$\frac{1}{6}$ One-Sixth Un sexto 17.5 x 16.2 cm 6 $\frac{3}{8}$ x 6 $\frac{1}{4}$ "	2.5" / 6.4 cm	1.2 QT / 1.1 L				
5781604			4" / 10 cm	2.1 QT / 1.9 L	575568	575569	NA	NA
5781606			6" / 15.2 cm	2.8 QT / 2.6 L				
5781902		$\frac{1}{9}$ One-Ninth Un noveno 17.5 x 10.8 cm 6 $\frac{7}{8}$ x 4 $\frac{1}{4}$ "	2.5" / 6.4 cm	0.8 QT / 0.7 L				
5781904			4" / 10 cm	1.1 QT / 1 L	575598	575599	NA	NA

ITEM #	DIM		DEPTH PROFUNDIDAD	CAP	SOLID COVER TAPA SÓLIDA	NOTCHED COVER TAPA CON HENDIDURAS	WIRE GRATE REJILLA	FALSE BOTTOM FONDO FALSO
5781112		$\frac{1}{1}$ Full Completo 53 x 32.4 cm 20 $\frac{3}{4}$ x 12 $\frac{3}{4}$ "	2.5" / 6.4 cm	8.2 QT / 7.7 L				
5781114			4" / 10 cm	14.8 QT / 14 L	575528	575529	575527	5788010
5781116			6" / 15 cm	21.2 QT / 20 L				
5781212		$\frac{1}{2}$ Half Mediano 26.4 x 32.4 cm 10 $\frac{3}{8}$ x 12 $\frac{3}{4}$ "	2.5" / 6.4 cm	4.3 QT / 4 L				
5781214			4" / 10 cm	7 QT / 6.6 L	575538	575539	575537	5788120
5781216			6" / 15 cm	10.6 QT / 10 L				

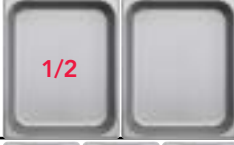
PERFORATED | PERFORADO

LIGHT WEIGHT.  304 STAINLESS STEEL ANTI-JAM 25 GAUGE / 0.5 MM.
ACERO INOXIDABLE 304 CALIBRE 25 / 0,5 MM. VOLUMEN BAJO.

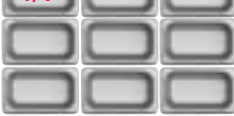
ITEM #	DIM		DEPTH PROFUNDIDAD	CAP	SOLID COVER TAPA SÓLIDA	NOTCHED COVER TAPA CON HENDIDURAS	WIRE GRATE REJILLA	FALSE BOTTOM FONDO FALSO
98002		1/1 Full Completo 53 x 32.4 cm 20 3/4 x 12 3/4"	2.5" / 6.4 cm	8.2 QT / 7.7 L				
98004			4" / 10 cm	14.8 QT / 14 L	575528	575529	575527	5788010
98006			6" / 15.2 cm	21.2 QT / 20 L				
98122		1/2 Half Mediano 26.4 x 32.4 cm 10 3/8 x 12 3/4"	2.5" / 6.4 cm	4.3 QT / 4 L				
98124			4" / 10 cm	7 QT / 6.6 L	575538	575539	575537	5788120
98126			6" / 15.2 cm	10.6 QT / 10 L				
98132		1/3 One-third Un tercio 26.4 x 32.4 cm 10 3/8 x 12 3/4"	2.5" / 6.4 cm	6.3 QT / 5.9 L				
98134			4" / 10 cm	10.1 QT / 9.5 L	575548	575549	PG510	N/A
98136			6" / 15.2 cm	15.7 QT / 14.8 L				
98142		1/4 One-Fourth Un cuarto 26.4 x 16.2 cm 10 3/8 x 6 3/8"	2.5" / 6.4 cm	2.2 QT / 2 L				
98144			4" / 10 cm	3.1 QT / 2.9 L	575558	575559	N/A	N/A
98146			6" / 15.2 cm	4.6 QT / 4.3 L				
98162		1/6 One-Sixth Un sexto 17.5 x 16.2 cm 6 7/8 x 6 1/4"	2.5" / 6.4 cm	1.2 QT / 1.1 L				
98164			4" / 10 cm	2.1 QT / 1.9 L	575568	575569	N/A	N/A
98166			6" / 15.2 cm	2.8 QT / 2.6 L				
98192		1/9 One-Ninth Un noveno 17.5 x 10.8 cm 6 7/8 x 4 1/4"	2.5" / 6.4 cm	0.8 QT / 0.7 L				
98194			4" / 10 cm	1.1 QT / 1 L	575598	575599	N/A	N/A



Full Size Chafer Dome Covers

Stainless steel polished exterior. Fits standard size pans.
25 / 0.6 mm gauge.

Tapas abovedadas para calentadores de mesa

Exterior lustrado. Tamaño grande. Para recipientes de tamaño estándar. Calibre 25 / 0.6 mm.

ITEM #	DIA	ITEM #	DIA
Solid Solida		Hinged Con bisagras	
575530	21.5 x 13 x 2.8" 54.6 x 33 x 7 cm	575532	21.5 x 13 x 2.8" 54.6 x 33 x 7 cm



Full Size Divided Pan

24 gauge, 0.6 mm. 18/8 Stainless steel. No adapter bars needed. 3.5 QT / 3.3 L capacity for each well.

Recipiente dividido, tamaño máximo

Calibre 24, 0.6 mm. Acero inoxidable 18/8. No se necesitan barras adaptadoras. Capacidad de cada receptáculo: 3.5 cuartos de galón (3.3L).

ITEM #	DIA (DXLXW)
578002	2.5 x 20.8" x 12.8" 6.4 x 52.7 x 32.4 cm



Notched
Con hendiduras

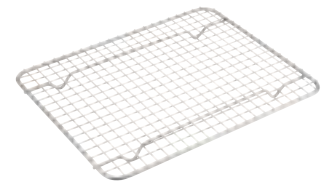

Steam Table Pan Covers

18/8 Stainless steel. Flat covers of medium weight. Helps prevent seepage or spills during transport.

Tapas para recipientes para mesas de vapor

Acero inoxidable 18/8. Tapas planas de peso mediano. Ayudan a evitar el rezumadero o los derrames durante el transporte.



Solid | Solida

ITEM #	SIZE	DIM (L X W)
575528	Full Completo	21 x 12.9" / 53.3 x 33 cm
575538	Half Mediano	12.8 x 10.4" / 32.4 x 26.5 cm
22240	Half, Long Mediano, long	20.8 x 6.4" / 53 x 16.2 cm
575548	One-Third Un tercio	12.8 x 7" / 32.4 x 17.8 cm
575558	One-Fourth Un quart	10.4 x 6.4" / 26.5 x 16.3 cm
575568	One-Sixth Un sexto	7 x 6.4" / 17.8 x 16.3 cm
575598	One-Ninth Un noveno	6.3 x 4.4" / 17.6 x 11.1 cm
575578	Two-Thirds Dos tercios	13.9 x 12.9" / 35.2 x 32.7 cm

Notched | Con hendiduras

ITEM #	Size	dim (L x W)
575529	Full Completo	21 x 12.9" / 53.3 x 33 cm
575539	Half Mediano	12.8 x 10.4" / 32.4 x 26.5 cm
575549	One-Third Un tercio	12.8 x 7" / 32.4 x 17.8 cm
575559	One-Fourth Un cuarto	10.4 x 6.4" / 26.5 x 16.3 cm
575569	One-Sixth Un sexto	7 x 6.4" / 17.8 x 16.3 cm
575599	One-Ninth Un noveno	6.3 x 4.4" / 17.6 x 11.1 cm
575579	Two-Thirds Dos tercios	13.9 x 12.9" / 35.2 x 32.7 cm

False Bottoms

Holds food above pan bottom for draining. Finger holes allow easy removal.

Fondos falsos

Mantienen los alimentos sin tocar el fondo del recipiente, para su mejor drenaje. Las perforaciones para los dedos permiten levantarlos fácilmente.

ITEM #	DES (W X L X D)	FITS PAN SIZE PARA TAMAÑO DE RECIPIENTE
5788120	8.4 x 10.8 x 0.6" / 21.3 x 27 x 1.4 cm	1/2 Half Mediano
5788010	9 x 17 x 0.6" / 22.9 x 43.2 x 1.4 cm	1/1 Full Completo

Footed Pan Grates

Nickel-plated steel wire.

Rejillas de alambre, con patas

Alambre de acero niquelado.

ITEM #	DIM (W X L X D)	FITS PAN SIZE PARA TAMAÑO DE RECIPIENTE
PG510	5 x 10 x 0.9" / 12.7 x 25.4 x 2.2 cm	1/3 One-Third Un tercio
575537	8 x 10 x 0.9" / 20.3 x 25.4 x 2.2 cm	1/2 Half Mediano
575527	10 x 18 x 0.9" / 25.4 x 45.7 x 2.2 cm	1/1 Full Completo



Stainless Steel Adaptor Bars

Prevents steam loss and Rojouces energy consumption.

Barras adaptadoras de acero inoxidable

Evitan las pérdidas de vapor y disminuyen la onsumición de energía.

ITEM #	DIM
5781110	20.6" / 52.3 cm
5781111	12.4" / 31.5 cm



Bain Maries

Stainless steel. Mirror finish exterior. Satin finish interior. Excellent storage containers. Covers available separately.

Cacerolas para baño maría

Acero inoxidable. Exterior con pulido espejo. Interior con acabado satinado. Excelentes contenedores para almacenar alimentos. Tapas disponibles separadamente.

ITEM #	CAP	DEPTH	FITS OPENING PARA
575771	1.3 QT / 1.2 L	4.8" / 12 cm	4.1" / 10.5 cm
575772	2 QT / 1.9 L	6.77" / 17.2 cm	4.9" / 12.4 cm
575773	3.5 QT / 3.3 L	6.8" / 17.5 cm	6.1" / 15.6 cm
575774	4.3 QT / 4 L	7.1" / 18 cm	6.7" / 16.8 cm
575776	6 QT / 5.7 L	8" / 20 cm	7.3" / 18.4 cm
575778	8.3 QT / 7.8 L	8.8" / 22 cm	8" / 20.3 cm
575782	12 QT / 11.4 L	10.7" / 27 cm	9.3" / 23.5 cm

Bain Marie Covers | Tapas de baño maría



ITEM #	FITS PARA	ITEM #	FITS PARA
5757711	575771	5757761	575776
5757721	575772	5757781	575778
5757731	575773	5757821	575782
5757741	575774		



vegetable Insets

Stainless Steel. Mirror finish exterior. Satin finish interior. Can be used in steam tables or soup warmers. Covers available separately.

Recipientes para vegetales

Acero inoxidable. Exterior con pulido espejo. Interior con acabado satinado. Pueden usarse en las mesas de vapor o calentadores de sopa. Tapas disponibles separadamente.

ITEM #	CAP	DIM (W)	FITS OPENING PARA
575581	2.4 QT / 2.2 L	5.4" / 14 cm	5" / 12.5 cm
575584	4.1 QT / 3.9 L	7.5" / 18.1 cm	6.5" / 16.5 cm
575587	7.1 QT / 6.7 L	9.5" / 24.1 cm	8.5" / 21.5 cm
575591	11 QT / 10.4 L	11.4" / 28.9 cm	10.5" / 26.5 cm



Vegetable Inset Covers

Stainless steel.

Couvercles para marmites à légumes

Acero inoxidable.

Hinged & Notched |
Con bisagras y muesca.

Notched |
Con hendiduras

ITEM #	FITS PARA	ITEM #	FITS PARA
575589	575587	575582	575581
575593	575591	575585	575584
		575588	575587
		575592	575591

Check Holder, Bar

Check clip. Aluminum. Holds paper in place using heat-resistant glass marbles. Easily usable with one hand.



Sujetadores de pedidos

Aluminio. Mantiene el apae en su lugar mediante bolitas de vidrio resistentes al calor. Fácil de usar con una sola mano.

ITEM #	DIM
576524	24 x 3.5" / 60 x 8.7 cm
576536	36 x 3.5" / 91 x 8.7 cm
576548	48 x 3.5" / 122 x 8.7 cm



INNOVA TOOLS

GERMAN CARBON STEEL BLADES,
HEAT TREATED AND TEMPERED FOR
DURABILITY

- Heat resistant nylon handle for up to 446°F / 230°C
- Comfortable 5" long ergonomic handle reduces hand fatigue
- Dual texture on handle ensures an improved grip even under greasy conditions
- Dishwasher safe



UTENSILIOS INNOVA

HOJAS DE ACERO AL CARBONO
ALEMÁN, TRATADAS Y
TEMPERADAS PARA UNA MAYOR
DURABILIDAD

- Mango resistente al calor a 446 °F / 230 °C.
- Cómodo mango ergonómico de 5" de largo que reduce la fatiga de la mano
- La textura doble en el mango garantiza un mejor agarre incluso en condiciones de grasa
- Aptos para lavavajillas





Browne innovation for high heat environment.

La principal solución de diseño de la industria para ambientes muy calientes

Perforated Turner Pala perforada

ITEM #	DIM	OVERALL LENGTH LARGO TOTAL
574365	3 x 8" 7.6 x 20.3 cm	14" / 35.6 cm



Turner Pala

ITEM #	DES	DIM BLADE (WXL) HOJA (LxL)	OVERALL LENGTH LARGO TOTAL
574378	Beveled Biselada.	3 x 4.5" 7.5 x 11.4 cm	10.7" / 27 cm
574363	Mini. No biselada.	2.5 x 2.5" 6.3 x 6.3 cm	8.3" / 21 cm



Turner Flexible 14.5" / 36.8 cm overall length.

Pala flexible
14.5" / 36.8 cm de largo total.

ITEM #	BLADE (W X L) HOJA (W X L)
574364	3 x 8" 7.6 x 20.3 cm



Fish Turner, Slotted 11.5" / 29.2 cm overall length.

Pala para pescado, con ranuras
11.5" / 29.2 cm de largo

ITEM #	BLADE (W X L) HOJA (W X L)
574383	3 x 7" 7.6 x 17.8 cm



Square End Turner, Beveled 12.8" / 32.4 cm overall length.

Pala con extremo cuadrado, biselada
12.8" / 32.4 cm de largo total.

ITEM #	BLADE (W X L) HOJA (W X L)
574376	3 x 6" 7.6 x 15.2 cm



Grill Scraper 9.75" / 24.75 cm overall length.

Raspador
9.75" / 24.75 cm de largo total.

ITEM #	BLADE (W X L) HOJA (W X L)
574380	4 x 4.5" 10 x 11.43 cm



Heavy Duty Turner, Beveled
11.7" / 29.5 cm overall length.

Pala para trabajo pesado, biselada
11.7" / 29.5 cm de largo total.

ITEM #	BLADE (W X L) HOJA (W X L)
574377	4 x 5" 10 x 12.7 cm



Pie/Cake Server
11.3" / 28.5 cm overall length.

Pala para servir pasteles
11.3" / 28.5 cm de largo total.

ITEM #	BLADE (W X L) HOJA (W X L)
574360	3 x 5" 7.6 x 12.7 cm



Pancake / Round Turner
14" / 30.6 cm overall length.

Pala Rojoonda para panqueques
14" / 30.6 cm de largo total.

ITEM #	BLADE (W X L) HOJA (W X L)
574384	7.5 x 6.5" 19 x 16.5 cm



Medium Turner
10.7" / 27 cm overall length.

Pala mediana
10.7" / 27 cm de largo total.

ITEM #	BLADE (W X L) HOJA (W X L)
574375	2.5 x 4" 6.3 x 10 cm



Deluxe Pie/Cake Server
10.5" / 26.7 cm overall length.

Pala para servir pasteles / tortas
10.5" / 26.7 cm de largo total.

ITEM #	BLADE (W X L) HOJA (W X L)
574361	2 x 5" 5 x 12.7 cm



Dough Cutter / Scraper
Polypropylene handle. Stainless steel blade. 6" / 15.2 cm overall length.

Cortador / raspador de pastelería, de lujo
Mango de polipropileno.
6" / 15.2 cm de largo total.

ITEM #	BLADE (W X L) HOJA (W X L)
574379	6 x 3" 15.2 x 7.6 cm



Large Turner, Beveled
13.3" / 33.7 cm overall length.

Pala para trabajo pesado, biselada
13.3" / 33.7 cm de largo total.

ITEM #	BLADE (W X L) HOJA (W X L)
574381	5 x 6" 12.7 x 15.2 cm



Spatula
Espátulas

ITEM #	BLADE (W X L) HOJA (W X L)	OVERALL LENGTH LARGO TOTAL
574386	1 x 6" 2.5 x 15.2 cm	11" / 27.9 cm
574388	1.3 x 8" 3.2 x 20.3 cm	13" / 33 cm
574390	1.5 x 10" 3.1 x 25.4 cm	15" / 38.1 cm
574392	1.8 x 12" 4.5 x 30.5 cm	17.3" / 43.8 cm



Butter Spreader, Serrated
8.3" / 21 cm overall length.

Untador de mantequilla, dentado
8.3" / 21 cm de largo total.

ITEM #	BLADE (W X L) HOJA (W X L)
574362	1.3 x 3.5" 3.2 x 9 cm

COLOUR-CODED PIZZA CUTTER

WITH HACCP COLOUR CODING SYSTEM. EASY TO INSERT CLIPS ON HANDLE

CORTADORES DE PIZZA, DE LUJO

CON SISTEMA DE CODIFICACIÓN DE COLORES HACCP, CLIPS DE FÁCIL INSERCIÓN PARA MANIPULACIÓN.

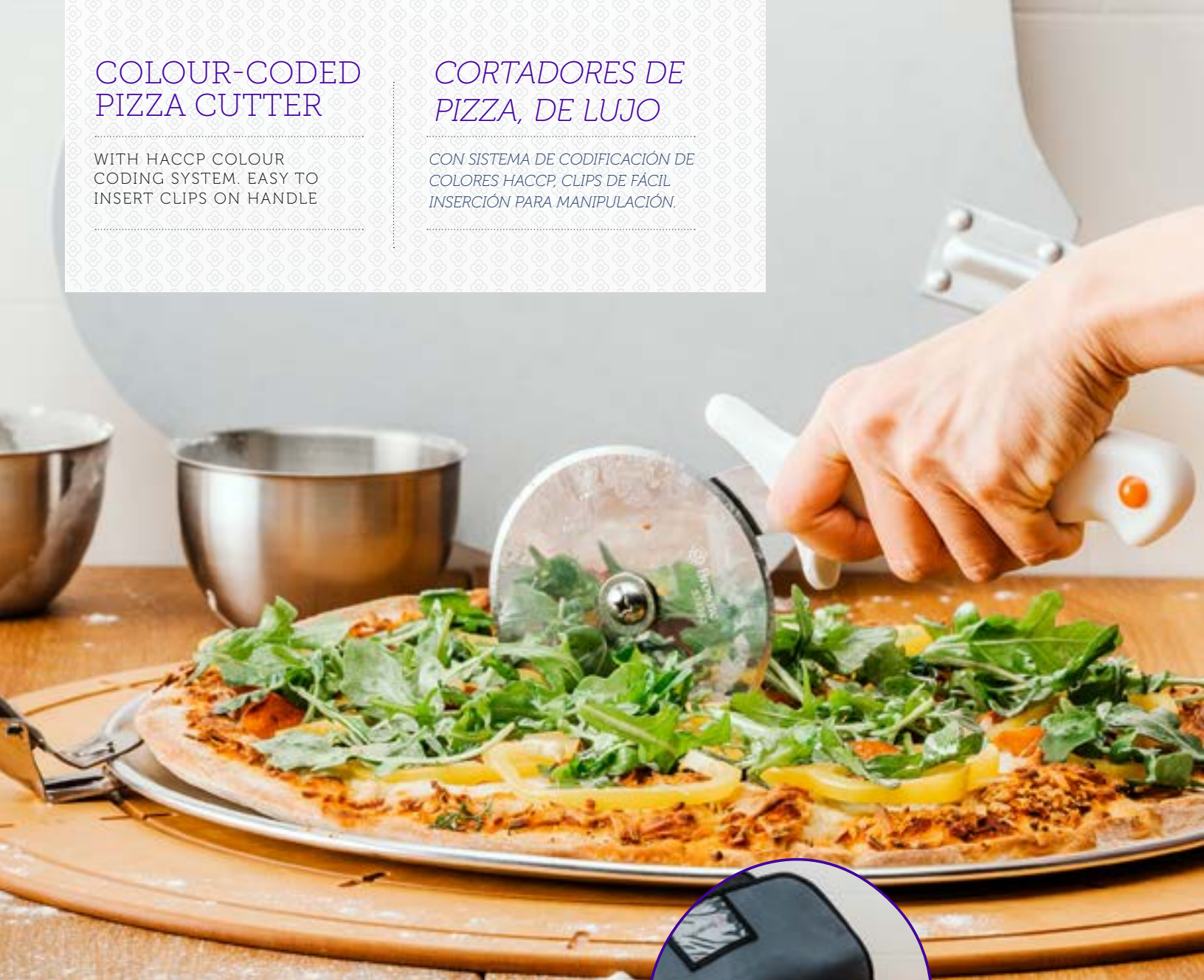

Pizza Cutter

Handle resistant up to 302°F / 150°C. Polypropylene handle. 9.5" / 24 cm overall length.

Cortadores de pizza, de lujo

Mango resistente al calor hasta los 302°F / 150°C. Mango de polipropileno. 9.5" / 24 cm de largo total.

ITEM # WHEEL DIA
DIA ROULETTE

574382 4" / 10 cm



See page 62 for our Delivery Bags.

Durable and water resistant. Multiple sizes available

Consulte la página 62 para ver nuestras bolsas de entrega.

Duradero y resistente al agua. Múltiples tamaños disponibles.



BLACK HANDLE TOOLS

HANDLE IS CONSTRUCTED IN SOLID ABS PLASTIC OVER STAINLESS STEEL FOR DURABILITY AND COMFORT.

Stainless steel tools perfect for everyday use and professional look in the kitchen

UTENSILIOS DE MANGO NEGRO

EL MANGO ESTÁ CONSTRUIDO EN PLÁSTICO ABS SÓLIDO SOBRE ACERO INOXIDABLE PARA MAYOR DURABILIDAD Y COMODIDAD.

Las herramientas de acero inoxidable son perfectas para el uso diario y presentan un aspecto profesional en la cocina.



One Piece Construction

Eliminates food traps for more sanitary use.

La construcción de una sola pieza elimina la captura de alimentos para un uso más higiénico.

Pie Server

Flexible. 1.0 mm thickness. 5.5" (14 cm) blade length.

Pala para servir pasteles

Flexible. 1.0 mm de espesor. 5.5" (14 cm) de largo de la hoja.

ITEM #	DIM
5744311	10.8" / 27.3 cm



Turner

Flexible. 1.0 mm thickness. 8 x 2.8" / 20.3 x 7 cm blade length.

Palas

Flexible. 1.0 mm de espesor. 18" x 2.8" / 20.3 x 7 cm de largo de la hoja.

ITEM #	DES	DIM
5744319	Perforated Perforada	14.5" / 36.8 cm
5744314	Solid Solida	14.5" / 36.8 cm

Pan / Griddle Scraper

Stiff. 1.2 mm thickness. 4.5 x 3" / 11.4 x 7.6 cm blade length.

Raspador de sartén / plancha

Rígido. 1.2 mm de espesor. 4.5 x 3" / 11.4 x 7.6 cm de largo de la hoja.

ITEM #	DIM
5744313	10" / 25.4 cm

Turner

Beveled Bladed. 1.0 mm thickness. 4.8 x 2.8" / 12 x 7 cm blade length.

Palas

Flexible. 1.0 mm de espesor. 4.8 x 2.8" / 12 x 7 cm de largo de la hoja.

ITEM #	DIM
5744315	12" / 30.5 cm

Sandwich Spreader

Serrated bladed. 0.8 mm thickness. 4" / 10.2 cm blade length.

Untador para sándwiches

Hoja dentada. 0.8 mm de espesor. 4" / 10.2 cm de largo de la hoja.

ITEM #	DIM
5744312	9.5" / 24.1 cm



BLACK HANDLE KNIFE

CUCHILLOS À MANCHES NOIRS

MADE WITH GERMAN STEEL
HECHO CON ACERO ALEMÁN



Cook's Knife Cuchillos de cocinero

ITEM #	DIM
PC1298	8" / 20.3 cm
PC12910	10" / 25.4 cm
PC12912	12" / 30.5 cm



Boning Knife Stiff

Cuchillo para deshuesar Rígido

ITEM #	DIM
PC1286	6" / 15.2 cm



Cleavers Hachas de cocinero

ITEM #	DIM
PC1216	6" / 15.2 cm
PC1218	8" / 20.3 cm



Slicers Rebanador

ITEM #	DIM
PC15410	10" / 25.4 cm



Paring Knives Stiff. 1.2 mm thickness.

Cuchillos de emparejamiento Rígido. 1.2 mm de espesor.

ITEM #	DIM
PC12625	3" / 7.6 cm



Paring Knives, 24 pack Cuchillos de emparejamiento, 24 piezas

ITEM #	DIM
574460	3.3 x 7.5" 8.3 x 19.1 cm



Bread Knife Wavy edge serrated blade.

Cuchillos de pan Borde ondulado, hoja dentada.

ITEM #	DIM
PC15510	10" / 25.4 cm
PC15512	12" / 30.5 cm



Sharpening Steel Chaira

ITEM #	BLADE HOJA
PC12002	12" / 30.5 cm

DIM
17.5" / 44.5 cm





WOODEN HANDLE TOOLS

STAINLESS STEEL, TEMPERED BLADES. HARDWOOD HANDLES WITH 2 OR 3 RIVETS

UTENSILIOS DE MANGO MADERA

HOJAS DE ACERO INOXIDABLE. HOJAS TEMPLADAS. MANGOS DE MADERA DURA. CON 2 O 3 REMACHES.



Stay Cool with Wooden Handle Utensils
Mantente Fresco con Utensilios de Mango de madera

All Purpose Spatula
7.5" / 19.1 cm overall length.
1.0 mm thickness.

Espátula multiuso
7.5" / 19.1 cm de largo total.
1.0 mm de espesor.

ITEM #	BLADE (L) HOJA (L)
574304	3.5 x 2" 8.9 x 5.1 cm



574320

574315

**Turner
Pala**

13.5" / 34.3 cm overall length
13.5" / 34.3 cm de largo total.

ITEM #	THICKNESS DE ESPESOR	BLADE (L) HOJA (L)
574320	1.0 mm	8 x 3" 20.3 x 7.6 cm

11.5" / 28.6 cm overall length.
Longueur totale de 11,5 po / 28,6 cm.

ITEM #	THICKNESS DE ESPESOR	BLADE (L) HOJA (L)
574315	1.8 mm	6 x 2.8" 15.2 x 7 cm



Turner
Long handle. Flexible.
20" / 50.8 cm overall length.

Pala
Mango largo. Flexible. 20" / 50.8 cm de largo total.

ITEM #	THICKNESS DE ESPESOR	BLADE (L) HOJA (L)
574316	1.0 mm	8 x 3" 20.3 x 7.6 cm



Stainless Steel Solid Turner
Flexible. 1.0 mm thickness.

Acero Inoxidable Pala
Flexible. 1.0 mm de espesor.

ITEM #	BLADE (L) HOJA (L)	OVERALL (L) LARGO (L)
574317	6.5 x 3" 16.5 x 7.6 cm	13" / 33 cm
574314	8 x 3" 20.3 x 7.6 cm	14.5" / 36.8 cm



Stainless Steel Solid Turner
Stiff. 13" / 33 cm overall length.

Pala Solida en acero inoxidable
Rígida. 13" / 33 cm de largo total.

ITEM #	THICKNESS DE ESPESOR	BLADE (L) HOJA (L)
574318	2.0 mm	5 x 6" 12.7 x 15.2 cm



Spatula
18/8 Stainless steel blade.

Spatules
Lame en acero inoxidable 18/ 8.

ITEM #	FINISH ACABADO	OVERALL LENGTH LARGO TOTALE	BLADE (L) HOJA (L)
573824	Straight / Flat Droites / Plat	4.5 x .75" / 11.4 x 1.9 cm	4¼" / 10.8 cm
573826	Straight / Flat Droites / Plat	6 x 1" / 15.2 x 2.5 cm	6" / 15.2 cm
573828	Straight / Flat Droites / Plat	8 x 1.25" / 20.3 x 3.2 cm	8" / 20.3 cm
573830	Straight / Flat Droites / Plat	10 x 1.5" / 25.4 x 3.8 cm	10" / 25.4 cm
573832	Straight / Flat Droites / Plat	12 x 1.5" / 30.5 x 5.1 cm	12" / 30.5 cm
573804	Offset Compensación	4.5 x .75" / 11.4 x 1.9 cm	3.5" / 8.9 cm
573806	Offset Compensación	6 x 1" / 15.2 x 2.5 cm	4.75" / 12 cm
573810	Offset Compensación	10 x 1.5" / 25.4 x 3.8 cm	8.5" / 21.6 cm



Turner
Perforated. 14.5" / 36.8 cm overall length.

Pala
Perforada. 14.5" / 36.8 cm de largo total.

ITEM #	THICKNESS DE ESPESOR	BLADE (L) HOJA (L)
574314P	1.0 mm	8 x 3" 20.3 x 7.6 cm



Grill Scraper
Stiff.

Raspador de parrilla
Rígida.

ITEM #	THICKNESS DE ESPESOR	DIM (L) (OVERALL X BLADE) (LARGO TOTAL X LARGO DE LA HOJA)
574313	1.2 mm	8 x 3" / 20.6 x 8 cm



Pot Fork
Stainless Steel. Forged blade.

Tenedor para ollas
Hoja de acero inoxidable. Forjado.

ITEM #	DIM
5551	14" / 35.6 m



Pie Server
Flexible. 10" / 25.4 cm overall length.

Pala para servir pasteles
Flexible. 10" / 25.4 cm de largo total.

ITEM #	THICKNESS DE ESPESOR	BLADE (L) HOJA (L)
574311	1.0 mm	5.5" / 14 cm



Sandwich Spreader
Serrated blade.

Untador para sándwiches
Hoja dentada.

ITEM #	THICKNESS DE ESPESOR	BLADE (L) HOJA (L)
574312	0.8 mm	3.75" / 9.5 cm



COLOR-CODED COLLECTION

AVOID CROSS-CONTAMINATION
WITH THE BROWNE FOODSERVICE
COLOR CODED COLLECTION

COLECCIÓN DE CODIFICADOS POR COLOR

*MANGOS DE ABS BIEN
BALANCEADOS QUE BRINDAN
MUCHOS AÑOS DE SERVICIO
COMERCIAL DE ALTO
VOLUMEN. ÚSELO CON LAS
TABLAS DE CORTE CODIFICADAS
POR COLOR DE BROWNE*



**Medium Density 1/2" Thick**

Polyethylene. Non-absorbent. Stain-resistant. Individually shrink-wrapped. Will not harbor food-borne bacteria.

Moyenne densité. Épaisseur de 1/2 po.

En polyéthylène. Non absorbantes. Résistent aux taches. Emballage individuel sous film de plastique rétractable. Ne favorisent pas le développement de bactéries.



DIM: 12 x 18 x 0.5" / 30.5 x 45.7 x 1.3 cm

ITEM # COLOUR | COULEUR

57361201 White | Blanc

57361203 Blue | Bleu

57361204 Green | Vert

57361205 Red | Rouge

57361212 Brown | Brun

57361216 Purple | Violet

57361217 Yellow | Jaune

DIM: 15 x 20 x 0.5" / 38.1 x 50.8 x 1.3 cm

ITEM # COLOUR | COULEUR

57361501 White | Blanc

57361503 Blue | Bleu

57361504 Green | Vert

57361505 Red | Rouge

57361512 Brown | Brun

57361516 Purple | Violet

57361517 Yellow | Jaune

DIM: 18 x 24 x 0.5" / 45.7 x 61 x 1.3 cm

ITEM # COLOUR | COULEUR

57361801 White | Blanc

57361803 Blue | Bleu

57361804 Green | Vert

57361805 Red | Rouge

57361812 Brown | Brun

57361816 Purple | Violet

57361817 Yellow | Jaune



DIM: 6 x 10 x 0.5" / 15.2 x 25.4 x 1.3 cm

With Handle | Avec poignée

ITEM # COLOUR | COULEUR

57360601 White | Blanc



26099

Cutting Board Storage

Steel construction with black powder coat finish. Holds ten (10) boards up to 1" thick.

Support pour planches à découper

Fabrication en acier avec fini noir revêtu de poudres. Accepte dix (10) planches d'une épaisseur maximale de 1 po.

ITEM # DIM

26099 12 x 11.5 x 11"
30.4 x 29.2 x 27.9 cm

**Cutting Boards**

Non-skid surface will not dull knives, chip, crack, peel or warp. Dishwasher safe. Both sides are usable.

**Planches à découper**

Surface antidérapante qui n'abîme pas les couteaux, ne s'écaille pas, ne pèle pas et ne voile pas. Vont au lave-vaisselle. Les deux côtés peuvent être utilisés.



573619

Collapsible plastic. Seven (7) slots. Plastique pliable. Sept (7) fentes.

ITEM # DIM

573619 10 x 9 x 7" / 25 x 23 x 18 cm



COLOR-CODED KNIVES

MADE OF THE FINEST GERMAN MOLYBDENUM STAINLESS STEEL

- Well balanced ABS handles are made to provide many years of heavy commercial service
- Use with Browne's matching color-coded cutting boards



CUCHILLOS CODIFICADOS POR COLOR

HECHOS DEL MEJOR ACERO INOXIDABLE DE MOLIBDENO ALEMÁN

- Mangos de ABS bien balanceados que brindan muchos años de servicio comercial de alto volumen.
- Úsalos con las tablas para cortar codificadas por color de Browne.



Cook's Knife
10" / 25.4 cm length

Cuchillos de cocinero
10" / 25.4 cm de longitud

ITEM #	COLOR
PC12910TN	Tan Tostado
PC12910WH	White Blanco
PC12910YL	Yellow Amarillo
PC12910BL	Blue Azul
PC12910GR	Green Verde
PC12910RD	Red Rojo



Boning Knife
Cuchillo para deshuesar

ITEM #	COLOR	DIM
PC1286RD	Red Rojo	6" / 15.2 cm



Knife Rack
Stainless steel. Holds: 5 knives, 2 cleavers, 2 steels. Rubber insert protects blades. Can be wall, counter or table mounted.

Porta cuchillos
Construcción de acero inoxidable. Se pueden guardar: 5 cuchillos, 2 hachas de cocinero (hachas), 2 chairas. La goma inserta en el interior protege las hojas. Se puede instalar en la pared, mostrador o mesa

ITEM #	DIM
HKP321	12 x 12.4 x 2.5" 30.5 x 32.7 x 6.35 cm

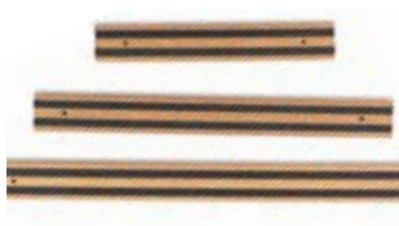

Magnetic Knife Rack
Permanent magnetism, no moving parts. Wood.

Porta cuchillos magnético
Magnetismo permanente, sin partes móviles. Madera.

ITEM #	DIM
MTH12	12" / 31.8 cm
MTH18	18" / 47.5 cm
MTH24	24" / 60.9 cm



Sharpening Stone
Finest quality silicon carbide stone.

Piedra afiladora
Piedra de carburo de silicio de calidad superior.

ITEM #	DIM
821	8 x 2 x 1" 20.3 x 5.1 x 2.5 cm



COLOR-CODED TONGS

STAINLESS STEEL WITH PVC COATING

- One piece construction eliminates food traps for more sanitary use



PINZAS CODIFICADOS POR COLOR

ACERO INOXIDABLE CON REVESTIMIENTO DE PVC

- Construcción de una pieza que elimina la acumulación de alimentos y garantiza un uso más sanitario.



One-Piece Tongs 1.0 mm Thickness.

Pinzas de una pieza 1.0 mm de espesor

9" / 23 cm

ITEM #	COLOR
5511BK	Black Negro
5511GR	Green Verde
5511RD	Red Rojo
5511YL	Yellow Amarillo

16" / 40.6 cm

ITEM #	COLOR
5513BK	Black Negro
5513GR	Green Verde
5513RD	Red Rojo
5513YL	Yellow Amarillo

12" / 30.5 cm

ITEM #	COLOR
5512BK	Black Negro
5512GR	Green Verde
5512RD	Red Rojo
5512YL	Yellow Amarillo
5512BL	Blue Azul



Color coded handle

help maintain food safety in your foodservice operation

Las asas codificadas por colores

ayudan a mantener la inocuidad de los alimentos en su servicio de comidas





COLOR-CODED DISHERS

MECHANISM. RIBBED, COLOR-CODED POLYPROPYLENE HANDLES WITH SIZE STAMPED FOR CONVENIENT SIZE REFERENCE.



PLATOS CODIFICADOS POR COLOR

MECANIZADO. ASAS DE POLIPROPILENO CODIFICADO POR COLOR CON EL TAMAÑO ESTAMPADO PARA UN CONVENIENTE REFERENCIA DE TAMAÑO.



Color-Coded Standard Dishers

Full loop release bar. Ribbed plastic handle for sure grip. Size stamped on bowl knife blade.

Cucharas para helado de acero inoxidable

Acero inoxidable con mango doble. Medidas estampadas en la cuchill.

ITEM #	COLOR	CAP	SIZE / TAMAÑO
573306	White Blanco	4.86 oz / 144 ml	6
573308	Gray Gris	3.71 oz / 110 ml	8
573310	Ivory Marfil	3.45 oz / 102 ml	10
573312	Green Verde	2.75 oz / 82 ml	12
573316	Blue Azul	2.25 oz / 66ml	16
573320	Yellow Amarillo	1.75 oz / 52 ml	20
573324	Red Rojo	1.35 oz / 40 ml	24
573330	Black Negro	1.08 oz / 32 ml	30
573340	Purple Púrpura	0.75 oz / 22 ml	40





COLOR-CODED MEASURES

COLOR-CODE
POLYPROPYLENE HANDLES
FOR CONVENIENT
SIZE REFERENCE. HEAT
RESISTANT TO
392°F / 200°C

- Heat resistant plastic coating for ease of serving
- Essential for proper portion control

MEDIDORES CODIFICADOS POR COLOR

MANGOS DE
POLIPROPILENO
RESISTENTES AL CALOR
HASTA 392°F / 200°C

- Revestimiento de plástico resistente al calor para facilitar el servicio



Color-Coded One-Piece Portioners

No weld joint where food can collect. 1.0 mm (.040") thickness. 10.8" / 27.4 cm overall length.

Cucharas de una pieza para servir porciones

Sin junta soldada donde la comida puede acumularse. 1.0 mm de espesor. 10.8" / 27.4 cm de largo total.

Solid Sólido	Perforated Perforado	COLOR	CAP
ITEM #	ITEM #		
5757420	5757421	Red Rojo	2 oz / 59 ml
5757430	5757431	Beige Beige	3 oz / 89 ml
5757440	5757441	Green Verde	4 oz / 118 ml
5757450	5757451	Yellow Amarillo	5 oz / 150 ml
5757460	5757461	Black Negro	6 oz / 177 ml
5757480	5757481	Blue Azul	8 oz / 236 ml

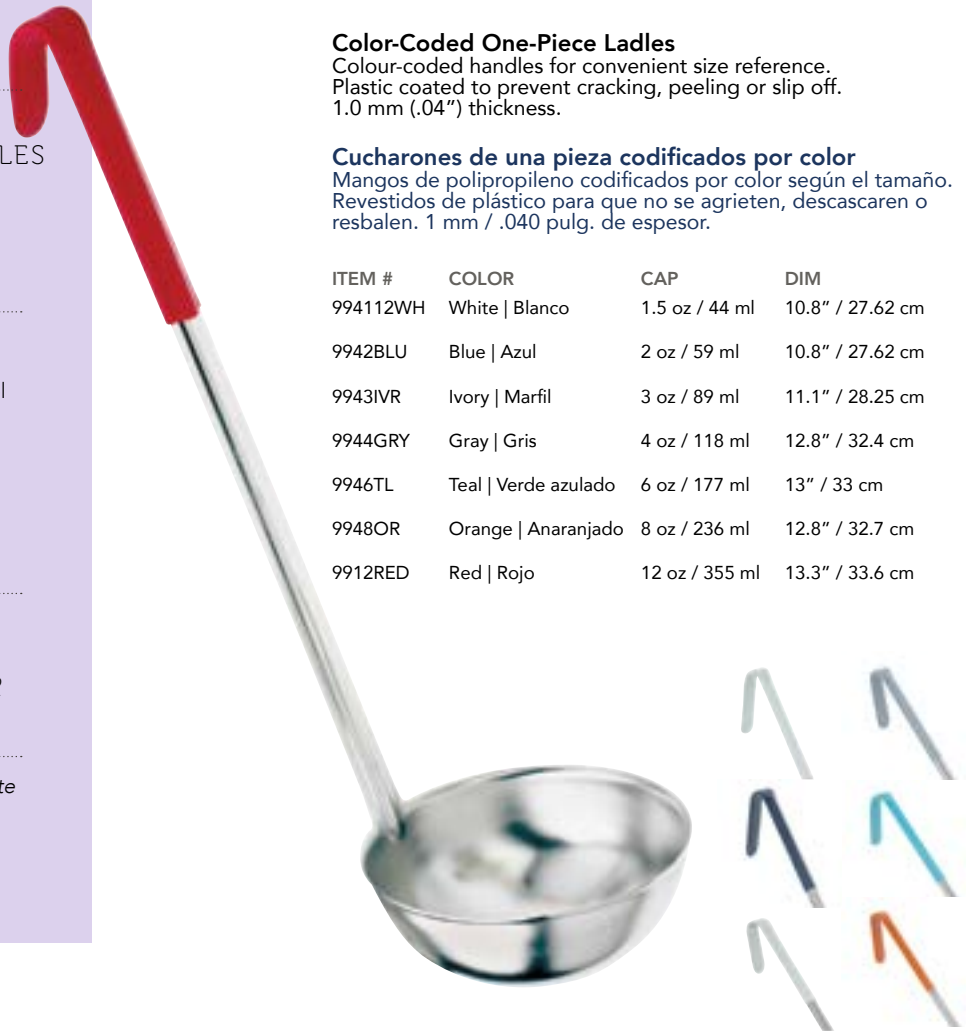

Color-Coded One-Piece Ladles

Colour-coded handles for convenient size reference. Plastic coated to prevent cracking, peeling or slip off. 1.0 mm (.04") thickness.

Cucharones de una pieza codificados por color

Mangos de polipropileno codificados por color según el tamaño. Revestidos de plástico para que no se agrieten, descascaren o resbalen. 1 mm / .040 pulg. de espesor.

ITEM #	COLOR	CAP	DIM
994112WH	White Blanco	1.5 oz / 44 ml	10.8" / 27.62 cm
9942BLU	Blue Azul	2 oz / 59 ml	10.8" / 27.62 cm
9943IVR	Ivory Marfil	3 oz / 89 ml	11.1" / 28.25 cm
9944GRY	Gray Gris	4 oz / 118 ml	12.8" / 32.4 cm
9946TL	Teal Verde azulado	6 oz / 177 ml	13" / 33 cm
9948OR	Orange Anaranjado	8 oz / 236 ml	12.8" / 32.7 cm
9912RED	Red Rojo	12 oz / 355 ml	13.3" / 33.6 cm



Black-Handled One-Piece Portioners

No weld joint where food can collect. Long, black polypropylene handle. Available in both perforated and solid. 1.0 mm (.040") thickness. 10.8" / 27.4 cm overall length.

Cucharas de una pieza con mango negro para servir porciones

Construcción de una pieza. Resistentes al calor hasta 200°C (392°F). Sin junta soldada donde la comida puede acumularse. Mango largo, negro de polipropileno. Disponibles ambas sólidas y perforadas. 1 mm / 0.040 de espesor. 10.8" / 27.4 cm de largo total.

Solid Sólido	Perforated Perforado	CAP
ITEM #	ITEM #	
5757220	5757221	2 oz / 59 mL
5757230	5757231	3 oz / 89 ml
5757240	5757241	4 oz / 118 ml
5757460	5757461	6 oz / 177 ml
5757280	5757281	8 oz / 236 ml





Black-Handled One Piece Ladles
Sizes stamped on handles to ensure fast and easy portion control. Plastic coated to prevent cracking, peeling or slip off. 1.0 mm (.04") thickness.

Cucharas de una pieza con mango negro para servir porciones. Una pieza de acero inoxidable. Medidas estampadas en los mangos a fin de asegurar un fácil y rápido control de las porciones. Revestidos de plástico para que no se agrieten, descascaren o se resbalen. Resistentes al calor hasta 200°C (392°F). 1 mm / 0.04 de espesor.

ITEM #	CAP	DIM
9941BLK	1 oz / 30 ml	11.1" / 28.25 cm
994112BLK	1.5 oz / 44 ml	10.8" / 27.62 cm
9942BLK	2 oz / 59 ml	10.8" / 27.62 cm
9943BLK	3 oz / 89 ml	11.6" / 29.5 cm
9944BLK	4 oz / 118 ml	12.8" / 32.7 cm
9946BLK	6 oz / 177 ml	13" / 33 cm
9948BLK	8 oz / 236 ml	12.8" / 32.7 cm



Stainless Steel One-Quart Dipper
With solder seal. 0.6 mm (.024") thickness.

Cazo de un cuarto de galón
Cazo de acero inoxidable con soldadura sellada. 0.6 mm / 0.024 de espesor.

ITEM #	CAP	DIM
72919	32 oz / 945 ml	12" / 31.8 cm



Conventional Two-Piece Ladles
Heavy gauge. Satin finish. Hooked handle for resting on pot rim or for hanging. 2.0 mm (.08") thickness.

Cucharón Conventional de dos piezas
De calibre pesado. Acabado satinado. Mango ganchudo para descansar en el borde de la olla o para colgar. Calibre 2.0 mm / 0.080 de espesor.

ITEM #	CAP	DIM
5747005	0.5 oz / 15 ml	10.5" / 26.6 cm
574701	1 oz / 29 ml	10.5" / 26.6 cm
574721	1 oz / 29 ml	7.5" / 19.1 cm
5747015	1.5 oz / 44 ml	9" / 22.9 cm
574702	2 oz / 59 ml	10.8" / 26 cm
574703	3 oz / 89 ml	10" / 25.4 cm
574704	4 oz / 118 ml	12" / 31.8 cm
574705	5 oz / 150 ml	12" / 31.8 cm
574706	6 oz / 177 ml	12.5" / 31.8 cm
574708	8 oz / 236 ml	12.8" / 31.1 cm
574712	12 oz / 355 ml	12.8" / 31.1 cm



Demi One-Piece Ladle
Stainless steel. Mirror finish. Has reinforced, grooved handle to remain rigid ensuring serving control. 1.0 mm (.04") thickness.

Cucharones Demi de una pieza
Acero inoxidable. Acabado espejo. Con mango reforzado y acanalado para mantener su rigidez y para mayor control al servir. 1 mm / .040 de espesor.

ITEM #	CAP	HANDLE MANGO
575726	0.5 oz / 15 ml	4.8" / 13 cm
575727	1 oz / 29 ml	5.8" / 14.7 cm



Optima One-Piece Ladle
Stainless steel, Mirror finish. One piece construction. Reinforced, grooved handle to remain rigid ensuring serving control. 1.0 mm (.04") thickness.

Cucharones de una pieza
Acero inoxidable con acabado espejo. Construcción de una pieza. Con mango reforzado y acanalado para mantener su rigidez y para mayor control al servir. Calibre 1 mm / 0.040 de espesor.

ITEM #	CAP	DIM
5757005	0.5 oz / 15 ml	10" / 25.4 cm
575701	1 oz / 29 ml	10.5" / 26.6 cm
575702	2 oz / 59 ml	11" / 27.9 cm
575703	3 oz / 89 ml	11.5" / 29.2 cm
575704	4 oz / 118 ml	12.5" / 31.8 cm
575706	6 oz / 177 ml	13" / 33 cm
575708	8 oz / 236 ml	13" / 33 cm
575712	12 oz / 355 ml	13" / 33 cm
575716	16 oz / 473 ml	13" / 33 cm
575724	24 oz / 710 ml	16" / 40.6 cm



Stainless Steel Ultra One-Piece Ladle
Super heavy-duty. 18/8. One-piece construction. 2.5 mm (.098") thickness.

Cucharones Ultra de una pieza
Cucharón de acero inoxidable 18/8 super resistente. Construcción de una pieza. Calibre 2.5 mm / 0.098 de espesor.

ITEM #	CAP	DIM
7741	1 oz / 29 ml	9.8" / 23.5 cm
7742	2 oz / 59 ml	9.8" / 23.5 cm
7743	3 oz / 89 ml	10" / 25.4 cm
7744	4 oz / 118 ml	13" / 33 cm
7746	6 oz / 177 ml	13" / 33 cm
7748	8 oz / 236 ml	13.5" / 34.3 cm



Cuisipro.

FIBERGLASS TOOLS

- Durability – 13% more fiberglass – adds strength making utensil durable enough for heavy-duty commercial use, won't crack, twist or bend
- Heat resistant to 455°F / 235°C
- Curved ergonomic handle features an "easy pick up" design when laying on a counter
- Flexible and pliable yet sturdy and strong
- Easy to clean

USTENSILES EN FIBRE DE VERRE

- Con un 13% de fibra de vidrio añadida al nylon, que hace los utensilios más duraderos y que evita que se rajen, se deformen o se doblen
- Resistentes al calor hasta 455° F / 235° C
- El mango curvo y ergonómico tiene un diseño "fácil de manipular" cuando se coloca en la encimera
- Flexibles y maleables, pero robustos y sólidos
- Fáciles de limpiar



Non-slip tip
Prevents tool from sliding into pots.

Su punta antideslizante
Evita que el utensilio se deslice dentro de la olla



Fiberglass Turner
Spatule fibre de verre

ITEM #	DIM
7112302	11.25" / 28.6 cm



Fiberglass Wide Turner
Spatule ajourée large fibre de verre

ITEM #	DIM
7112322	11.25" / 28.6 cm



Fiberglass Spaghetti Server
Cuillère à spaghetti fibre de verre

ITEM #	DIM
7112312	12" / 30.5 cm



Fiberglass Slotted Spoon
Cuillère ajourée fibre de verre

ITEM #	DIM
7112308	11.75" / 29.8 cm



Fiberglass Serving Ladle
Louche fibre de verre

ITEM #	DIM
7112324	12" / 30 cm



Fiberglass Basting Spoon
Cuillère fibre de verre

ITEM #	DIM
7112303	11.75" / 29.8 cm

Ambidextrous Stainless Steel Dishers

Stainless steel with a twin grip. Size stamped on blade.

Cucharas para helado de acero inoxidable

Acero inoxidable con mango doble. Medidas estampadas en la cuchilla.

ITEM #	CAP	SIZE / TAMAÑO
573408	4 oz / 118 ml	8
573410	3.8 oz / 111ml	10
573412	3.3 oz / 96 ml	12
573416	2.8 oz / 81 ml	16
573420	2.5 oz / 66 ml	20
573424	1.8 oz / 52 ml	24
573430	1.3 oz / 37 ml	30
573440	0.9 oz / 26 ml	40
573450	0.6 oz / 19 ml	50
573460	0.56 oz / 16.5 ml	60
573470	0.5 oz / 14 ml	70
5734100	0.4 oz / 11 ml	100

**Stainless Steel Ice Cream Spade**

Spade is a one-piece stainless steel blade with a black plastic handle.

Paleta para helado

La paleta es una hoja de una pieza de acero inoxidable con mango de plástico negro.

ITEM #	DIM
571465	9.8" / 23.5 cm

**Aluminum One-Piece Ice Cream Dipper**

Color-coded caps. One piece cast aluminum. Corrosion and break resistant. Handwash only. Not for heat exceeding 140°F / 60°C.

Cucharas para helado de aluminio de una pieza
Código de color en el extremo del mango. Hecha en un solo bloque de aluminio. A prueba de corrosión y roturas. Lavar sólo a mano. No apto para temperatura mayor a 60°C / 140°F.

ITEM #	CAP	COLOR	SIZE / TAMAÑO
571412	3 oz / 89 ml	Yellow Amarillo	12
571416	2.5 oz / 66 ml	Green Verde	16
571420	2 oz / 59 m	Brown Marrón	20
571424	1.5 oz / 44 ml	Red Rojo	24

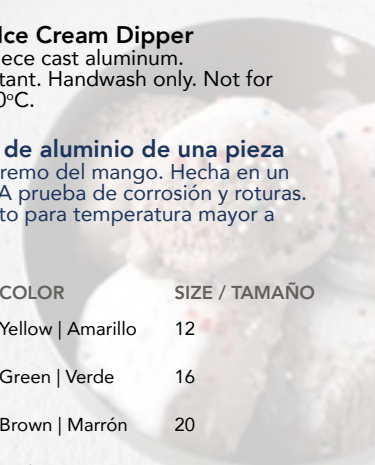



RENAISSANCE SERVING SPOONS

CURVED HANDLE DESIGN
- AN INDUSTRY FIRST

- Heavy duty curved handle ensures they rest safely on the edge and do not slide into food vessels

CUCHARAS DE SERVIR LÍNEA RENAISSANCE

DISEÑO DE MANGO
CURVO; EL PRIMERO DE
LA INDUSTRIA

- El mango curvo en nuestras resistentes cucharas de servir Renaissance garantiza que descansen con seguridad en los borde y no se deslicen hacia los recipientes de alimentos

Open Angle

of curves promotes easy pickup from any countertop. Increasing hygiene safety.

El Ángulo Abierto

de la curva promueve una fácil extracción desde cualquier encimera.



Heavy Duty Renaissance Curved Serving Spoons.

Stainless Steel. Satin Finish. Will not bend or break with normal use. Grooved handle for added durability. 1.75 mm thickness.

Cucharas de servir línea Renaissance, Curvas.

Acero Inoxidable. Acabado satinado. No se dobla o rompe con el uso normal. Mango acanalado para mayor durabilidad. 1.75 mm de espesor.

ITEM #	DES	DIM	THICKNESS DE ESPESOR
4765	Solid Sólida	13" / 33 cm	1.75 mm
4766	Perforated Perforada	13" / 33 cm	1.75 mm
4767	Slotted Con ranuras	13" / 33 cm	1.75 mm
4775	Solid Sólida	15" / 38.1 cm	1.75 mm
4776	Perforated Perforada	15" / 38.1 cm	1.75 mm
4777	Slotted Con ranuras	15" / 38.1 cm	1.75 mm

Renaissance Serving Spoons

Stainless steel. Will not bend or break with normal use. Satin finish. Grooved handle for added durability. 1.75 mm thickness.

Cucharas de servir línea Renaissance

Acero inoxidable. No se dobla o rompe con el uso normal. Acabado satinado. Mango acanalado para mayor durabilidad. 1.75 mm de espesor.

ITEM #	DES	DIM
4750	Solid Sólida	11" / 27.9 cm
4760	Solid Sólida	13" / 33 cm
4770	Solid Sólida	15" / 38.1 cm
4752	Perforated Perforada	11" / 27.9 cm
4762	Perforated Perforada	13" / 33 cm
4772	Perforated Perforada	15" / 38.1 cm
4754	Slotted Con ranuras	11" / 27.9 cm
4764	Slotted Con ranuras	13" / 33 cm
4774	Slotted Con ranuras	15" / 38.1 cm





Conventional Serving Spoons

Stainless steel. Mirror finish. Grooved handles for added durability. With full-length reinforcement rib.

Cucharas de servir "Conventional"

Acero inoxidable. Pulido espejo. Mangos acanalados para mayor durabilidad. Con nervadura de refuerzo a todo lo largo.

ITEM #	DES	DIM
1.0 mm Thickness / Espesor		
572111	Solid Sólida	11" / 27.9 cm
572131	Solid Sólida	13" / 33 cm
572151	Solid Sólida	15" / 38.1 cm
572112	Perforated Perforada	11" / 27.9 cm
572132	Perforated Perforada	13" / 33 cm
572152	Perforated Perforada	15" / 38.1 cm
572113	Slotted Con ranuras	11" / 27.9 cm
572133	Slotted Con ranuras	13" / 33 cm
572153	Slotted Con ranuras	15" / 38.1 cm

ITEM #	FINISH / ACABADO	DIM
1.5 mm Thickness / Espesor		
2750	Solid Sólida	11" / 27.9 cm
2760	Solid Sólida	13" / 33 cm
2770	Solid Sólida	15" / 38.1 cm
2752	Perforated Perforada	11" / 27.9 cm
2762	Perforated Perforada	13" / 33 cm
2772	Perforated Perforada	15" / 38.1 cm
2754	Slotted Con ranuras	11" / 27.9 cm
2764	Slotted Con ranuras	13" / 33 cm
2774	Slotted Con ranuras	15" / 38.1 cm



Extra Long Handled Utensils

Stainless steel. Mirror finish. Reinforced handle with a deep groove for added strength. 1.5 mm thickness.

Utensilios con mango extralargo

Acero inoxidable. Acabado espejo. Mango reforzado con una nervadura profunda para mayor resistencia. 1.5 mm de espesor.

ITEM #	DES	DIM
4780	Solid Sólida	18" / 45.7 cm
4783P	Perforated Perforada	18" / 45.7 cm
4781	Solid Sólida	21" / 53.3 cm
4782	Fork Tenedor	21" / 53.3 cm
4784P	Perforated Perforada	21" / 53.3 cm



ITEM #	DES	DIM BLADE HOJA	OVERALL LENGTH LARGO TOTAL
573714	Solid Sólida	5.9 x 3" / 15 x 7.6 cm	14" / 35.5 cm
573716	Slotted Con ranuras	5.9 x 3" / 15 x 7.6 cm	14" / 35.5 cm



Hook Handled Utensils

Stainless steel. Satin finish. Handles are 2.0 mm thick, with full length reinforcement rib.

Utensilios con mango ganchudo

Acero inoxidable. Los mangos tienen 2 mm de espesor, Acabado satinado. Con nervadura de refuerzo a todo lo largo.

ITEM #	DES	DIM
85949	Fork Tenedor	15" / 38.1 cm
85946	Fork Tenedor	21" / 53.3 cm
85943	Spoon Cuchara	21" / 53.3 cm
85952	Perforated Spoon Cuchara perforada	21" / 53.3 cm
85955	Turner Pala	21" / 53.3 cm





Black Handled Serving Spoons

Stainless steel. Black polypropylene handles, with a hanging hole. Grooved handle for added durability. 1.5 mm thickness.

Note: 3-sided spoons have rounded handles.

Cucharas de servir con mango negro

Acero inoxidable. Mangos negros de polipropileno con orificio para colgar. Mango acanalado para mayor durabilidad (Nota: las cucharas de tres lados tienen mangos Rojoondeados.) 1.5 mm de espesor.

ITEM #	FINISH ACABADO	DIM
572311	Solid Sólida	11" / 27.9 cm
572331	Solid Sólida	13" / 33 cm
572351	Solid Sólida	15" / 38.1 cm
572312	Perforated Perforada	11" / 27.9 cm
572332	Perforated Perforada	13" / 33 cm
572352	Perforated Perforada	15" / 38.1 cm
572313	Slotted Con ranuras	11" / 27.9 cm
572333	Slotted Con ranuras	13" / 33 cm
572353	Slotted Con ranuras	15" / 38.1 cm

3 Sided Spoons | Con 3 lados

ITEM #	FINISH ACABADO	DIM
5761	Solid Sólida	13" / 33 cm
5763	Perforated Perforadas	13" / 33 cm



Grill / Fry Tongs

Wide shape tip picks up larger size food. Holes allow easy draining of fats and oils. Dishwasher safe.

Tenacillas para asar a la parrilla/freír

Su punta de forma ancha permite agarrar alimentos de gran tamaño. Los orificios permiten escurrir fácilmente las grasas y aceites. Lavable en el lavaplatos.

ITEM #	DIM
57599	12" / 30.5 cm



Fryer Tong

18/10 stainless steel. Easy to use locking pull mechanism. Holes allow easy draining of fats and oils. Easy hang hook. Grooved and offset handle allows secure grip and quick pick-up. Made of rust and weather resistant.

Tenacillas para asar a la parrilla/freír

Sus agujeros permiten escurrir fácilmente las grasas y los aceites. Mecanismo de cierre fácil de usar. Práctico gancho para colgar. Su mango estriado permite un agarre seguro. Hechas de acero inoxidable 18/10 resistente a la herrumbre y las condiciones climáticas para darle años de uso intensivo.

ITEM #	DIM
747304	16" / 40.5 cm

Utility Tongs

Stainless steel. Coil spring operated. Scalloped edges. Individually poly-bagged.

Pinzas para todo uso

Acero inoxidable. Funciona con resorte espiral. Bordes festoneados. Empaque individual en bolsas de poly.

ITEM # DIM

0.5 mm thickness. Mirror Finish. Standard.
0.5 mm de espesor. Pulido espejo. Estándar.

57536 7" / 17.8 cm

57527 9.5" / 24 cm

57528 12" / 30.5 cm

57529 16" / 40.6 cm

1.0 mm thickness. Mirror Finish.
1.0 mm de espesor. Pulido espejo.

57547 9.5" / 24 cm

57548 12" / 30.5 cm

57549 16" / 40.6 cm

1.0 mm thickness. Satin Finish.
1.0 mm de espesor. Acabado satinado.

57537 9.5" / 24 cm

57538 12" / 30.5 cm

57539 16" / 40.6 cm

1.2 mm thickness. Mirror Finish.
1.2 mm de espesor. Pulido espejo.

4511 9.5" / 24 cm

4512 12" / 30.5 cm

4513 16" / 40.6 cm

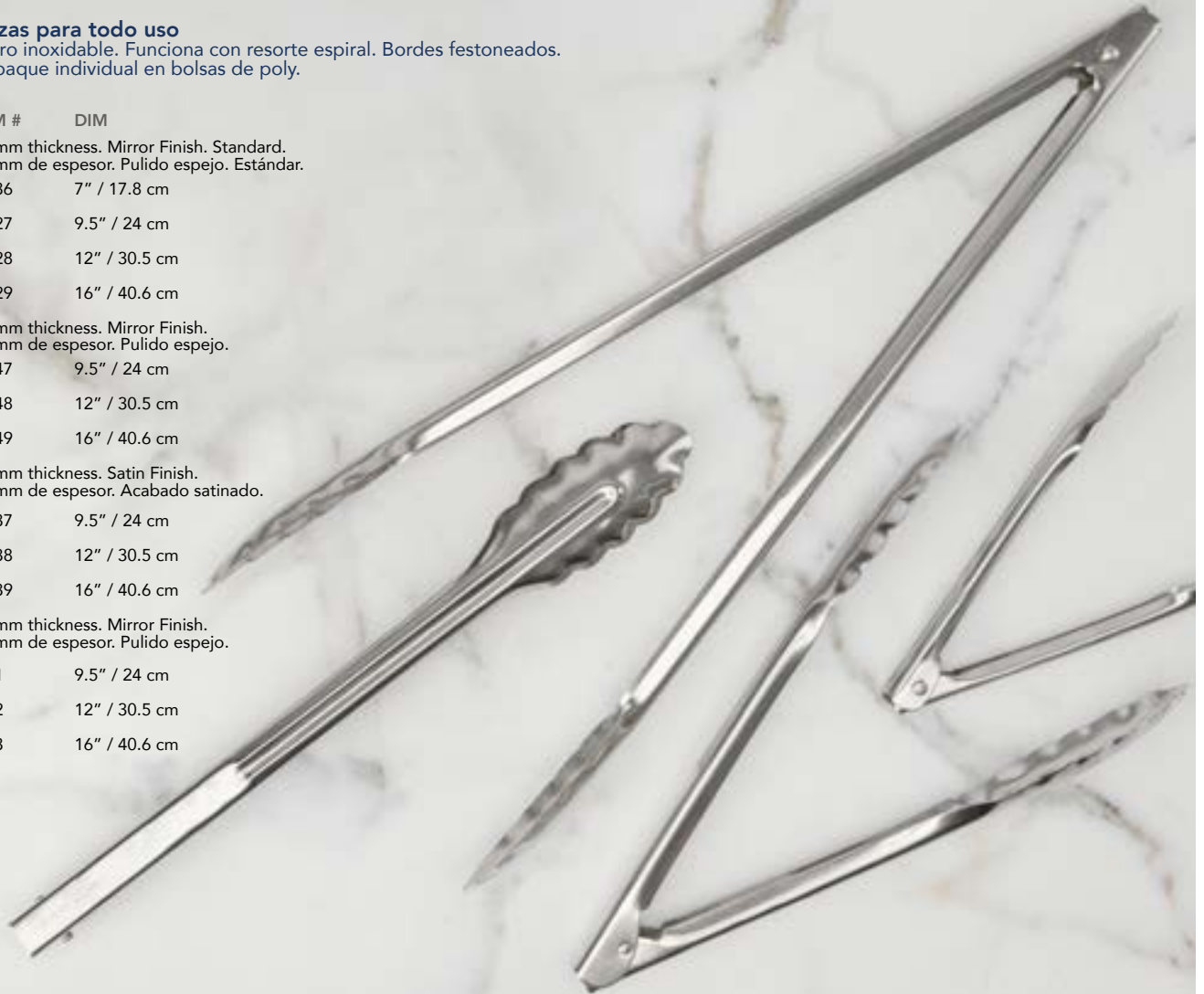
**Cuisipro****Silicone Locking Tongs**

Designed to handle both cooking and serving tasks with ease. Patented locking pull mechanism. Push to open. Pull to lock. Tongs can be opened with one hand. Loop for hanging. Non-stick silicone ends. Heat/resistant to 575°F / 300°C. Commercial quality. Dishwasher safe.

Pinzas de Silicona con mecanismo de bloqueo – Negras

Diseñadas para un fácil uso tanto al cocinar como al servir. Mecanismo de bloqueo patentado de extracción. Empuje para abrir. Tire para bloquear. Las pinzas se pueden abrir y cerrar con una sola mano. Bucle para colgar. Puntas de silicona antiadherente resistentes al calor hasta 575°F / 300°C. Acero inoxidable de calidad comercial. Producto apto para el lavavajillas.

ITEM #	FINISH ACABADO	DIM
74708602	Black Negro	9.5" / 24 cm
74708702	Black Negro	12" / 30.5 cm
74708605	Red Rojo	9.5" / 24 cm
74708705	Red Rojo	12" / 30.5 cm

Cuisipro**Patented Locking Tong**

Designed to handle both cooking and serving tasks with ease. Patented locking pull mechanism. Push to open. Pull to lock. Tongs can be opened with one hand. Loop for hanging. Commercial-quality stainless steel. Dishwasher safe.

US PAT NO 6056338

Pinzas de acero inoxidable con mecanismo de bloqueo

Diseñadas para un fácil uso tanto al cocinar como al servir. Mecanismo de bloqueo patentado de extracción. Empuje para abrir. Tire para bloquear. Las pinzas se pueden abrir y cerrar con una sola mano. Bucle para colgar. Acero inoxidable de calidad comercial. Producto apto para el lavavajillas.

PAT. DE EE.UU. N.º 60563388

ITEM #	DIM
57577	9.5" / 24 cm
57578	12" / 30.5 cm
57579	16" / 40.6 cm





Precision Tongs

Allows chefs to place small, delicate food precisely.

Pinzas de Precisión

Le permite al chef colocar alimentos delicados con precisión



57515

Curved: Bent end for placement at different angles
Curva: Punta curva para usar en diferentes ángulos.



57516

Straight: Versatile, can be used in many applications
Recta: Muy versátil para diferentes aplicaciones.



57517

Offset: Fine tip for precise placement of small ingredients
En ángulo: Punta fina para ingredientes pequeños.

Precision Tongs

18/8 Stainless steel. Serrated inside tips for better grip on food. Available in curved, straight, offset.

Pinzas De Precisión

18/8 Acero inoxidable. Puntas aserradas en su interior para mejor agarre. Disponible en modo angulado, recto y curvo.

ITEM #	DES	DIA
57515	Curved Curvo	8" / 20.3 cm
57516	Straight Recta	8" / 20.3 cm
57517	Offset En angulo	8" / 20.3 cm



Pom Tongs

Stainless steel. One-piece construction. 0.7 mm thickness.

Pinzas "Pom"

Acero inoxidable. Construcción de una sola pieza. 0.7 mm de espesor.

ITEM #	DIM
57530	6" / 15.2 cm

57531	9" / 23 cm
-------	------------



Spaghetti Tongs

Spring steel with blunted top on each side. 0.6 mm thickness.

Pinza para fideos

Resorte de acero con puntas romas de cada lado. 0.6 mm de espesor.

ITEM #	DIM
57533	7.5" / 19.1 cm



Stainless Steel Spaghetti Fork

Mirror finish. Grooved handle for added strength and blunted tips for easier noodle serving. 1.2 mm thickness.

Tenedor para fideos

Acero inoxidable. Pulido espejo. Mango acanalado para mayor resistencia y puntas romas para servir los fideos con mayor facilidad. 1.2 mm de espesor.

ITEM #	DIM
71073	11.5" / 29.2 cm





Double Mesh, Fine
Coladores de doble trama, fino

ITEM #	DIM
18096	6.25" / 16 cm
18098	8" / 20.3 cm
18099	10.25" / 26 cm



STAINLESS STEEL STRAINERS

RUST RESISTANT,
DISHWASHER SAFE.
CONSTRUCTED WITH
A LARGE GAUGE WIRE
STRUCTURE & A SANITARY
PLASTIC HANDLE.
DRAINAGE HOLE ON RIM
FOR CLEANLINESS

COLADORES DE ACERO INOXIDABLE

RESISTIR LA OXIDACIÓN.
CONSTRUIDO CON
UNA ESTRUCTURA DE
ALAMBRE DE GRAN
CALIBRE Y UN MANGO
DE PLÁSTICO SANITARIO.
ORIFICIO DE DRENAJE
EN EL BORDE PARA LA
LIMPIEZA.



Single Mesh, Fine
Colador de una sola trama, fino

ITEM #	DIM
19095	4.75" / 12 cm
19096	6.25" / 16 cm
19097	7.25" / 18.4 cm
19098	8" / 20.3 cm
19099	10.25" / 26 cm



Single Mesh, Medium
Colador de una sola trama,
mediano

ITEM #	DIM
19195	4.75" / 12 cm
19196	6.25" / 16 cm
19197	7.25" / 18.4 cm
19198	8" / 20.3 cm
19199	10.25" / 26 cm



Double Mesh, Medium
Coladores de doble trama,
medianos

ITEM #	DIM
18196	6.25" / 16 cm
18198	8" / 20.3 cm
18199	10.25" / 26 cm





9099



9091



8095



574131

Single Mesh Strainers

Full-bathed tinned. Wood handle.

Colador de una sola trama

Completamente bañados en estaño. Mango de madera.

ITEM #	BOWL TAZÓN	HANDLE MANGO	ITEM #	BOWL BOL	HANDLE MANGO
Fine Fino			Medium Mediano		
9093	4.8" / 12.1 cm	5.8" / 13.3 cm	574115	5.5" / 14 cm	6" / 15.2 cm
9094	5.5" / 14 cm	6" / 15.2 cm	574116	6.8" / 15.8 cm	6" / 15.2 cm
9095	6.8" / 15.8 cm	6" / 15.2 cm	574117	7.8" / 18.4 cm	6" / 15.2 cm
9096	7.8" / 18.4 cm	6" / 15.2 cm	574118	8" / 20.3 cm	6.5" / 16.5 cm
9098	8" / 20.3 cm	6.5" / 16.5 cm	574120	10.8" / 26 cm	9" / 22.9 cm
9099	10.8" / 26 cm	9" / 22.9 cm			
Wire handle Mango de alambre.					
9091	2.75" / 7 cm	4" / 10.2 cm			
9092	4" / 10.2 cm	4.5" / 11.4 cm			

Double Mesh Strainers

Full-bathed tinned. Wood handle.

Coladores de doble trama

Completamente bañados en estaño. Mango de madera.

ITEM #	BOWL TAZÓN	HANDLE MANGO
Fine Fino		
8095	6.8" / 15.9 cm	6" / 15.2 cm
8098	8" / 20.3 cm	6.5" / 16.5 cm
8099	10.8" / 26 cm	9" / 22.9 cm
Medium Mediano		
574126	6.8" / 15.9 cm	6" / 15.2 cm
574128	8" / 20.3 cm	6.5" / 16.5 cm
574130	10.8" / 26 cm	9" / 22.9 cm

Heavy Duty Strainers

Rigid double-mesh construction, with reinforcing bands. Heavy wooden handle. Medium mesh. Full-bathed tinned.

Coladores muy resistentes

Construcción rígida de doble trama, con bandas de refuerzo. Mango pesado de madera. Trama mediana. Completamente bañados en estaño.

ITEM #	BOWL TAZÓN	HANDLE MANGO
574131	9" / 22.9 cm	8" / 20.3 cm
574132	10.8" / 26 cm	8" / 20.3 cm
574133	12" / 30.5 cm	16" / 40.6 cm
9250	14" / 35.6 cm	16.25" / 41.3 cm



Round Shape Skimmers

Brightly polished stainless steel. Long, hooked handle serves as a pot rest. Handle length: 13.7" / 35 cm

Espumaderas

Acero inoxidable lustrado brillante. El mango largo y ganchudo sirve para colgar de la olla. Handle length: 13.7" / 35 cm.

ITEM #	DIA
375	6" / 15.2 cm



Nickel Plated Skimmers

Rigid, long handle displaces heat. Square mesh. Handle length: 14" / 35.6 cm.

Espumaderas niqueladas

El mango largo y rígido desplaza el calor. Trama a cuadros. Largo del mango: 14" / 35.6 cm.

ITEM #	DIA
571925	6" / 15.2 cm
1307T	7" / 17.8 cm
571926	8" / 20.3 cm
1309T	9" / 23 cm
571928	12" / 30.5 cm



Nickel Plated Spiral Wire Skimmers

Long, hooked handle displaces heat and allows for a greater reach. Coarse mesh. Spiral wire. Handle length: 17.6 / 44.5 cm.

Espumaderas niqueladas con alambre en espiral

El mango largo y ganchudo desplaza el calor y permite un mayor alcance. Trama gruesa. Alambre en espiral.

ITEM #	DIA
1306	6" / 15.2 cm
1307	7" / 17.8 cm
1308	8" / 20.3 cm
1309	9" / 23 cm

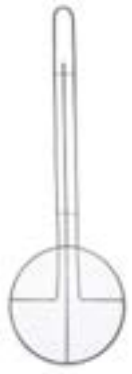

571923



997

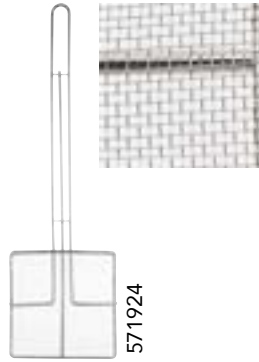

571924

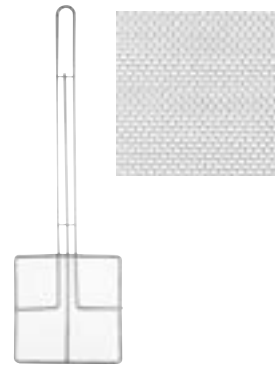

Fine Mesh Skimmers

Nickel-plated. One-piece handle is low-heat transferring.
Handle length: Round: 14" / 35.6 cm Square: 11.8" / 30 cm

Espumadera de trama fina

Mango de una pieza transmite poco calor. Niquelado.
Largo del mango: Rojondo: 14" / 35.6 cm. Cuadrado: 11.8" / 30 cm

ITEM #	DES	DIM	HANDLE MANGO
997	Square Cuadrado	5 x 6" / 12.7 x 15.2 cm	11.5" / 29 cm
571923	Round Redondo	6.5" / 16.5 cm	13" / 33 cm
571924	Square Cuadrado	6.5" / 16.5 cm	13.5" / 34 cm

Medium Mesh Skimmers

Stainless steel. One-piece handle is low-heat transferring. Handle length: 14.5" / 36.8 cm

Espumadera de trama

Mango de una pieza transmite poco calor. Acero inoxidable. Largo del mango: Rojondo: 14.5" / 36.8 cm.

ITEM #	DES	DIM
571922	Square Cuadrado	6.5 x 6.5" / 16.5 x 16.5 cm



Bouillon Strainer

Stainless steel with extra-fine mesh. Pan hook provides stability while straining. 8" / 20.3 cm.

Coladores de consomé

Acero inoxidable con trama extra fina. El gancho para colgarlo de la cacerola le proporciona estabilidad cuando se cuean líquidos. 8" / 20.3 cm.

ITEM #	DES
575515	Regular Regular
575514	With reinforcement bar Con barra de refuerzo



Soup Strainer

18/8 Stainless steel with perforated metal body. One-piece grooved handle for added strength. Frame style dissipates heat.

Coladores

Acero inoxidable resistente 18/8 con cuerpo de metal perforado. Mango acanalado de una pieza para mayor fuerza, con un estilo que también dispersa el calor.

	ITEM #	DIM	CAP		ITEM #	DIM	CAP
	575407	7" / 17.8 cm	1.7 QT / 1.5 L		575507	7" / 17.8 cm	1.7 QT / 1.5 L
FINE MESH MALLA FINA	575408	8" / 20.3 cm	2.3 QT / 2.2 L		575508	8" / 20.3 cm	2.3 QT / 2.2 L
	575409	9" / 23 cm	2.8 QT / 2.6 L		575509	9" / 23 cm	2.8 QT / 2.6 L
	575410	10" / 25.5 cm	4 QT / 3.7 L	COARSE MESH MALLA GRUESA	575510	10" / 25.4 cm	4 QT / 3.7 L
	575412	12" / 30.5 cm	6.8 QT / 6.4 L		575512	12" / 30.5 cm	6.8 QT / 6.4 L



Bouillon Strainer

18/8 Stainless steel with extra-fine mesh. Pan hook provides stability while straining.

ITEM # / DES	DIM (LXHXW)
575414 With reinforcement bar Avec barre de renforcement	18.25 x 9 x 9 46.3 x 22.8 x 22.8cm
575415	18.25 x 9 x 9 46.3 x 22.8 x 22.8cm

Coladores de consomé

Acero inoxidable con trama extra fina. El gancho para colgarlo de la cacerola le proporciona estabilidad cuando se cuean líquidos.





Wire Fry Basket

Heavy nickel-plated wire frame. Medium mesh.

Canastas de alambre para freír

Estructura niquelada de alambre grueso. Malla mediana.

ITEM #	DIM
79090	8.5" / 21.6 cm
79100	9.5" / 24.1 cm
79120	11.5" / 29.2 cm



Wire Fry Basket

Nickel-plated. single wire construction. Coloured plastic handle.

Canastas de alambre para freír

Estructura niquelada. Construcción con un solo alambre. Mango plástico de color.

ITEM #	COLOR	DIA X HT
79204	Green Verde	13 x 5.5 x 5.5" 33 x 14 x 14 cm
79207	Red Rojo	13 x 5.5 x 5.5" 33 x 14 x 14 cm
79213	Green Verde	13.6 x 6.75 x 5.3" 33 x 17 x 13.5 cm
79216	Red Rojo	13.6 x 6.75 x 5.3" 33 x 17 x 13.5 cm



Taco Basket

Heavy-duty construction features a fry kettle hook and a polished chrome finish. Handle has a low heat-transferring design. For use in 28-35 lb. or larger fry kettles. Holds up to eight shells per load.

Cesto para tacos

Construcción muy resistente con un gancho para colgar de la freidora y acabado en cromo pulido. El mango transmite poco calor. Para usarse con freidoras de 12-15 kg (28-35 libras) o más. Con espacio para 8 tacos.

ITEM #	DIM
79218	12 x 6.5 x 3" 30.5 x 16.5 x 7.6 cm

Culinary Basket

Nickel-plated steel wire.

Cestos para cocinar

Alambre de acero niquelado.

FINISH ACABADO	ITEM #	DIM
Fine Fino 1/8" / 0.3 cm	79751	8" / 20.3 cm
	79754	10" / 25.4 cm
	79757	12" / 30.5 cm
Medium Mediano 1/4" / 0.6 cm	79741	8" / 20.3 cm
	79744	10" / 25.4 cm
	79747	12" / 30.5 cm
Coarse Grueso 1/2" / 1.3 cm	79731	8" / 20.3 cm
	79734	10" / 25.5 cm
	79737	12" / 30.5 cm



Deluxe Egg Slicer

Stainless Steel Cutting Wires. Nickel plated zinc body. ABS rubber-coated wire guides. 18/8 stainless steel hinge pin. Slip-resistant base. Slice or wedge mode:
- 9 wires for slices
- 3 cross wires cut 6 wedges.

Rebanador de huevo, de lujo

Alambres cortadores de acero inoxidable: Cuerpo de cinc niquelado. Guías para los alambres de ABS revestido de caucho. Pasador de la bisagra de acero inoxidable 18/8. Base resistente al deslizamiento.
- 9 alambres, para cortar en rebanadas
- 3 alambres en cruz, para cortar en 6 secciones.

ITEM #	DIA
575685	4.5 x 3.5" 11 x 9 cm



Single Egg Slicer

Made of die-cast polished aluminum.

Rebanador de huevo

Hecho de aluminio fundido pulido.

ITEM #	DIA
746685	4.8" / 10.8 cm





Heavy Duty Aluminum Colanders

Stand alone base for hands free draining. Riveted handles and rounded edges for added strength. Well-curved design ensures effective draining. 3/16" / 0.5 cm holes. 3.0 mm thickness.

Passoires en aluminium robustes

Base autoportante pour un usage mains libres. Poignées rivetées et rebord arrondi pour plus de rigidité. La conception courbée permet à l'eau de s'écouler de façon efficace. Trous de 3/16 po / 0,5 cm. Épaisseur de 3,0 mm.

ITEM #	CAP	DIA
Depth Profondeur 5.8" / 14.6 cm		
5811611	10.5 QT / 10.5 L	15" / 38.1 cm
Depth Profondeur 7.3" / 18.1 cm		
5811616	15 QT / 15 L	16" / 41.9 cm

Footed Colanders

Stainless steel. Mirror finish. 0.4 mm thickness.

Passoires sur pied

Acier inoxydable. Fini miroir. Très durable et résiste aux bosselures. Épaisseur de 0,4 mm.

ITEM #	CAP	DIA	ITEM #	CAP	DIA
746038	3 QT 2.8 L	8.5" 21.6 cm	746110	8 QT 7.6 L	13" 33 cm
746109	5 QT 4.8 L	10.3" 26.7 cm	746111	13 QT 12.3 L	15.3" 38.7 cm



European Style Stainless Steel Colanders

Mirror finish. Wide, deep bottom and tall sides allow water to drain quickly. Wide steady round stable base. Large, looped handles for secure grip.

Passoires de style européen. Acier inoxydable.

Fini miroir. Le fond large et profond et les parois hautes permettent à l'eau de s'écouler rapidement. La base ronde et large offre une plus grande stabilité. Grandes poignées circulaires pour une prise solide.

ITEM #	CAP	DIA
Depth Profondeur 5.8" / 14.6 cm		
575950	7.25 QT / 6.9 L	12.5" / 32 cm
Depth Profondeur 7.3" / 18.1 cm		
575952	16 QT / 15 L	15.75" / 40 cm



Mixing Bowls

Stainless steel. Mirror finish. Rolled edge.

Bols à mélanger

Acier inoxydable. Fini miroir. Rebord roulé.

0.4 mm Thickness | Épaisseur de 0,4 mm

ITEM #	CAP	DIA
574950	0.75 QT / 0.76 L	6.5" / 16.5 cm
574951	1.5 QT / 1.4 L	7.8" / 20 cm
574953	3 QT / 2.8 L	9.5" / 24.5 cm
574954	4 QT / 3.7 L	10.5" / 27 cm
574955	5 QT / 4.7 L	11.5" / 30 cm
574956	6.75 QT / 6.4 L	12.5" / 30.5 cm
574958	8 QT / 7.8 L	13.3" / 34 cm
574960	10.5 QT / 9.9 L	15" / 38.1 cm
574963	13 QT / 12.3 L	16" / 40.6 cm

0.5 mm Thickness | Épaisseur de 0,5 mm

574966	16 QT / 15 L	17.7" / 45 cm
574970	20 QT / 19 L	19" / 48 cm



Heavy Duty Deep Mixing Bowls

18/8 stainless steel. Mirror finish. Satin interior. Rolled edge. 0.7 mm thickness.

Bols à mélanger profonds robustes

Acier inoxydable 18/8. Fini miroir. Intérieur satiné. Rebord roulé. Épaisseur de 0,7 mm.

ITEM #	CAP	DIA
575900	0.75 QT / 0.76 L	5.3" / 13 cm
575901	1.5 QT / 1.4 L	6.9" / 18 cm
575903	3 QT / 2.8 L	8.7" / 22 cm
575904	4 QT / 3.7 L	9.8" / 25 cm
575906	6 QT / 5.7 L	10.9" / 28 cm
575908	8 QT / 7.8 L	11.8" / 30 cm
575912	12 QT / 11.35 L	14" / 36 cm



Heavy Duty Mixing Bowls

18/8 stainless steel. Mirror finish. Satin interior. Rolled edge. 0.7 mm thickness.

Bols à mélanger robustes

Acier inoxydable 18/8. Fini miroir. Intérieur satiné. Rebord roulé. Épaisseur de 0,7 mm.

ITEM #	CAP	DIA
575930	10 QT / 9.5 L	14.5" / 36.5 cm
575933	12 QT / 11.35 L	16.3" / 41 cm
575936	16 QT / 15 L	17.5" / 44.5 cm



Potato Masher
Stainless Steel.

Pasapuré
Acero inoxidable.

ITEM #	LENGTH LARGO	FACE CARA
575442	15" 38.1 cm	5 x 3.3" 12.7 x 9.5 cm



Nickel-Plated Masher
One-piece base. Securely welded base rods. Hardwood handle.

Pasapurés niquelados
Base de una pieza. Varillas de la base firmemente soldadas. Mango de madera dura.

ITEM #	LENGTH LARGO	FACE CARA
1618	18" 45.7 cm	4 x 4" 10.2 x 10.2 cm
1623	23" 58.4 cm	5 x 5" 12.7 x 12.7 cm



Masher
Stainless steel. Round face. Hardwood handle.

Pasapurés Rojoondos
Mango de madera dura. Cara Rojoondeada. Mango de madera.

ITEM #	LENGTH LARGO	FACE CARA
575441	18" 45.7 cm	4 x 4" 10.2 x 10.2 cm
1725	25" 63.5 cm	5 x 5" 12.7 x 12.7 cm



Stainless Steel Round Face Masher
Round face.

Pasapurés Rojoondos en acero inoxidable
Todo de acero

ITEM #	LENGTH LARGO	FACE CARA
1726	25" 63.5 cm	5" 12.7 cm



746193

Potato Ricer
Stainless Steel. Heavy duty. Large portion. Bowl securely welded to frame.

Prensapapas
Acero inoxidable. Muy resistente. Porción grande. Bol soldado firmemente al armazón.

ITEM #	DIA	FACE CARA
746193	17" 43.1 cm	5 x 4.5" 12.7 x 11.4 cm
746192	9" 23 cm	



746192



Garnish / Serrator
Stainless steel corrugated blade. Hardwood handle. Use to make French Fries, carrot slices and other garnishes.

Sierra ondeada para guarniciones
Cuchilla acanalada de acero inoxidable. Mango de madera dura. Se puede utilizar para cortar papas fritas, rodajas de zanahorias y otras guarniciones.

ITEM #	DIM
574309	7 x 2" 17.8 x 5.1 cm



Heavy-Duty Garlic Press
Heavy-duty die-cast aluminum construction. Self-cleaning, plate of poly teeth pushes through holes.

Prensador de ajo muy resistente
Construcción de aluminio fundido muy resistente. Plancha dentada poly autolimpiante que atraviesa las perforaciones.

ITEM #	DIM
575769	8" / 20.3 cm



Steel Poultry Shears
Made of forged steel. Spring-operated with built-in bone crusher. Chromed steel finish.

Tijeras para aves de corral de acero
De acero forjado. A resorte con triturador de huesos incorporado.

ITEM #	DIM
1219	9.5" 24.1 cm



Fruit / Vegetable Peelers
Double-edge floating blade.
Can be used for scraping and coring
Stainless steel.

Pela frutas/verduras
Acero inoxidable. Cuchilla flotante
de doble filo. Puede utilizarse para
raspar y despepitar.

ITEM #	DIM
575690	2.5" / 6.3 cm



Tomato Corer
Stainless steel. Quickly scoops core.

Descorazonador de tomate
Acero inoxidable. Para sacar
rápidamente el corazón del
tomate

ITEM #	BASE
71894	4.8" / 10.8 cm



Melon Ballers
Polished stainless steel bowls.

Balones de melo
Balones de melon con cuencos de
acero inoxidable pulido.

ITEM #	BOWL BOL	DIA
1226SP	1" / 2.5 cm	2.5 x 7" 3.1 x 17.8 cm



575687



575688

Oyster Knife
Hardwood handle.

Cuchillo para ostra
Mango de madera dura.

ITEM #	FINISH ACABADO	DIM
575687	Carbon steel Acero al carbono	3" / 7.6 cm
575688	Stainless steel Acero inoxidable	3" / 7.6 cm



Steak Weights
Ribbed flat bottom. Wooden handle. Keeps edges of steaks from
curling during cooking.

Pesos para carne
Fondo plano acanalado. Mango de madera. Evita que los bordes de
los filetes se curven durante la cocción.

Aluminum Aluminio		Gray Iron Hierro gris	
ITEM #	DIM	ITEM #	DIM
705	8.25 x 4.25" 20.9 x 10.8 cm	706	9 x 5.8" 22.6 x 13 cm
707	9 x 5.8" 22.6 x 13 cm	709	8.25 x 4.25" 20.9 x 10.8 cm
708	11 x 9" 22 x 22.8 cm		

PARTS | PARTES

ITEM #	DIM
707H	Replacement Handle for 707 Mango de repuesto para 707



574725

Steak Tenderizer
One face is coarse cut, other is fine cut.

Ablandador de carne
Grueso de un lado y fino del otro.



574726

ITEM #	DES	LENGTH BLADE LARGO (HOJA)	LENGTH OVERALL LARGO TOTAL
574725	Cast aluminum head. Wood handle. Cabezal de aluminio fundido. Mango de madera dura.	2.5" / 3 cm	10.5" / 26.7 cm
574726	Cast aluminum head Cabezal de aluminio fundido	3" / 7.6 cm	11.8" / 29.8 cm



Commercial Heavy-Duty Can Opener

Cast iron body. Handle has a comfortable free-spin grip. Plated steel mounting plate with screws. Heat-treated gear for extra durability. Reversible knife provides longer service. Replacement gears & knives available. Open cans up to 11" high.

Abrelatas muy resistente profesional

Cuerpo de hierro fundido. Mango con cómoda agarradera que gira libremente sobre su propio eje. Placa para montar con tornillos, de acero enchapado. Mecanismo tratado al calor para una mayor durabilidad. Cuchilla reversible que brinda un servicio más prolongado. Disponibles mecanismo y cuchillas de repuesto. Abrir latas de hasta 11" / 33 cm de alto".



ITEM #	SHAFT ARBRE
574064	13" / 33 cm

PARTS | PARTES

ITEM #	DES
574064-1	Knife/ Blade Cuchilla de corte
574064-2	Gear Le elengranaje



Swing-A-Away® Can Opener

Chrome-plated rotary knife type, gear operated. Also includes a cap remover

Abrelatas portátil Swing-A-Way®

Cromado, con cuchilla rotativa. Funciona a engranaje. Incluye imán para sacar la tapa.

ITEM #	DIM
574058	7" / 17.8 cm



Can Opener

Chrome plated steel with polypropylene handles. Large easy to turn key-handle and smooth cutting mechanism.

Abrelatas

Acero cromado con mango de polipropileno. Mango grande tipo llave fácil de dar vuelta y mecanismo para cortar sin problemas.

ITEM #	DIM
574456	8" / 20.3 cm



Pasta Machine

Pasta maker features, 1 roller blade with 9 thickness options to create pasta sheets as well as 2 cutting options to make linguine or spaghetti. Ergonomic handle for comfort when turning, table clamp and instruction booklet included. Stainless steel.

Máquina de pasta

La hacedora de pasta incluye 1 hoja de rodillo con 9 opciones de grosor para crear fideos y 2 opciones de corte para hacer linguini o espagueti. Asa ergonómica para mayor comodidad al girar, incluye abrazadera para mesa y manual de instrucciones. Acero inoxidable.

ITEM #	DIA
575205	7.5 x 7.5 x 5" / 19.1 x 19.1 x 12.7 cm



French Fry Cutter

Heavy-duty cast body. Cast iron handle. Stainless steel trough. The frame, pusher block and cutting frame are all rust-proof. Wall or table-mounted. Potato capacity: 6" / 15.2 cm long, up to 50 lb. / 22.7 kg per hour.

Cortador de papas fritas

Estructura principal muy resistente y manija de hierro fundido. Bandeja de acero inoxidable. El armazón, la placa para prensar y el armazón para cortar son inoxidables. Se puede instalar en la pa. Rojo o mesa. Capacidad: una papa de 15.2 cm (6 pulg.) de largohasta 22.7 kg (50 libras) por hora.

ITEM #	CUT CORTE
5720375	3/8" / 1 cm

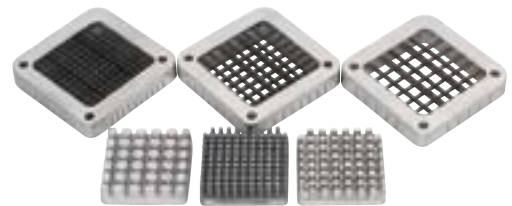

French Fry Cutter Parts

Blade set only. (Blade kits consisting of frame with blades and pusher block.)

Repuestos para el cortador de papas fritas

Cuchillas sohojante (juego). (Juegos de cuchillas que constan de marco con cuchillas y bloque de empuje).

PARTS | PARTES

ITEM #	DES	DIA	ITEM #	DIA
37512	Set Juego	1/2" / 1.3 cm	Cutting frame Marco de corte	
37514	Set Juego	1/4" / 0.6 cm	H15	3/8" / 1 cm
37538	Set Juego	3/8" / 1 cm	H15C	1/4" / 0.6 cm
			H15F	1/2" / 1.3 cm
			Pusher blocks Bloques de empuje	
			H16	3/8" / 1 cm
			H16B	1/4" / 0.6 cm
			H16P	1/2" / 1.3 cm



KitchenGrips. PRO

PROFESSIONAL FOOD SAFETY HAND PRODUCTS

SUPERIOR HEAT PROTECTION. UP TO -134°F TO 500°F / -92°C TO 260°C. WATER REPELLENT, SAFE NON-SLIP GRIP. STAIN-RESISTANT AND DISHWASHER SAFE



PRODUITS PROFESSIONNELS POUR UNE MANUTENTION SÉCURITAIRE

PROTECTION SUPÉRIEURE CONTRE LA CHALEUR (-92 °C À 260 °C / -134 °F À 500 °F). PRISE SÉCURITAIRE ANTIDÉRAPANTE HYDROFUGE. ANTITACHES. VONT AU LAVE-VAISSELLE



Exclusive FLXa-Prene™
Non-porous material.

FLXa-Prene™MD exclusif
Matériau non poreux.



Puppet Mitt
With straight and inverted zig-zag stitching. Black.

Agarraderas tipo títere
Con costura zig-zag invertida. Negro.

ITEM #	DIM
5434102	15" / 38 cm
5434202	17" / 43 cm



Oven Mitt with Kevlar Gusset
FLXaPrene non-porous material with DuPont Kevlar gusset. Black.

Guante para el horno con refuerzo de Kevlar
Material no poroso FLXaPrene con refuerzo de DuPont Kevlar. Negro.

ITEM #	DIM
5441502	13.75" / 34.9 cm
5441802	16.38" / 41.6 cm

Oven Mitt

Superior heat resistant up to 482°F / 250°C.

Manoplas para el horno

Superior resistencia al calor hasta de 482°F / 250°C.

ITEM #	DIM
5431202	10.75" / 30.5 cm
5431502	13.75" / 39.4 cm
5431802	16.38" / 41.6 cm



3-Finger Mitt

3-Finger configuration provides added dexterity. Features Nomex® binding. Black.

Manoplas de 3 dedos

La configuración de 3 dedos permite una mayor destreza. Con costura de Nomex®. Negro.

ITEM #	DIM
5443602	16.38" / 41.6 cm



Oven Mitt

With Nomex® binding. Black.

Mitaines de four

Avec revêtement Nomex^{MD}. Noir.

ITEM #	DIM
5432202	10.75" / 30.5 cm
5432502	13.75" / 39.4 cm
5432802	16.38" / 41.6 cm



Deluxe Puppet Mitt

With Nomex® palm for added protection against wear and tear. Black.

Mitaines marionnette deluxe

Avec paume en Nomex^{MD} pour une protection supplémentaire contre l'usure. Noir.

ITEM #	DIM
5443502	15" / 38 cm



5 Finger Glove

Kevlar stitching. Straight and inverted zig-zag stitching. Black.

Gaunte de 5 dedos

Costuras de Kevlar. Puntadas rectas e invertidas en zig-zag. Negro.

ITEM #	DIM
5430502	15" / 38 cm
5430702	17" / 43 cm



Flame Retardant Oven Mitts
Cotton. Coated with aluminized silicone. Non-stick coating easily wipes clean. Protects up to 200°F / 93°C. Sold in pairs. Made in USA.

Manoplas para horno
Se venden en pares. Fabricadas en EE.UU. Todo algodón. Protegen hasta los 93°C / 200°F.

ITEM #	DIM
SOM15	15" / 38 cm
SOM17	17" / 43 cm



Flame Retardant Oven Mitts
All cotton. Protects up to 400°F / 204°C. Water and stain repellent. Sold in pairs. Made in USA.

Manoplas para horno
Se venden en pares. Fabricadas en EE.UU. Todo algodón. Protegen hasta los 93°C / 200°F.

ITEM #	COLOR	DIM
FRM15	Cream Crema	15" / 38 cm
FRM17	Cream Crema	17" / 43 cm
POM13	Canvas Lona	13" / 33 cm
POM15	Canvas Lona	15" / 38 cm
POM17	Canvas Lona	17" / 43 cm
POM24	Canvas Lona	24" / 60.9 cm

Pan Handle Sleeve
Interior coated with aluminized silicone. Cotton. Protects up to 200°F / 93°C. Made in USA.

Agarrador
Interior recubierto con silicona aluminizada. Algodón. Fabricado en EE.UU.

ITEM #	DIM
AH-6	6 x 2.8" / 15.2 x 7 cm



8" Pot Holder
Coated with aluminized silicone. Protects up to 200°F / 93°C. Made in USA.

Agarrador
Recubierto de silicona aluminizada. Protege hasta los 93°C / 200°F. Fabricado en EE.UU.

ITEM #	DIM
PHS8	8 x 8" / 20.3 x 20.3 cm



Pan Handle Sleeve
Black.

Funda para mango de sartén
Negro.

ITEM #	DIM
5439002	6 x 3" / 15.2 x 7.6 cm



Safe Server Finger Hot Pad
Superior heat protection (-134°F to 500°F, -92°C to 260°C).

Agarradera segura al servir, con anillo para el pulgar
Protección superior al calor. Hasta -134 °F a 500 °F / 92 °C a 260 °C.

ITEM #	DIM
5437102	7" / 17.8 cm



Ultra Thick Hot Pad
1/4" / 0.6 cm thick, single layer construction.

Posafuentes ultra gruesos
0.6 cm (1/4 pulg.) de espesor, hechos de una sola capa.

ITEM #	DIA
5442002	7" / 17.8 cm
5442102	10" / 25.4 cm



Hot Pads
Zig-zag stitching.

Agarraderas
Con costura en zigzag derecha.

ITEM #	DIM
5436102	7" / 17.8 cm
5436502	10" / 25.4 cm

French Roll please!
Cookie, pie and tart dough should be rolled with a light touch
the French style is the ideal choice.

¡Panecillos, por favor!
Las masas de galletas, pasteles y tartas deben estirarse con un ligero
toque. El estilo francés es la elección ideal.



French Rolling Pin
Wood. Tapered.

Pasador de rodillo de madera
Francesa. Hueco.

ITEM #	DIM
744246	20.5 x 1.75" 52 x 4 cm



Aluminum Rolling Pins

A classic design updated with aluminum for an easy cleaning rolling pin. Ball bearing roller. Cast aluminum 3 1/2" / 8.9 cm barrel.

Rodillos de aluminio

Diseño clásico actualizado con aluminio para brindar un rodillo de fácil limpieza. Con cojinete. Cilindro de 8.9 cm (3 1/2 pulg.) de aluminio fundido.

Barrel | Barril 15 x 3.5" / 38 x 9 cm
Handle | Mango 4.24" / 10.7 cm

ITEM #	DIM
844715	23.5" / 60 cm

Barrel | Barril 18 x 3.5" / 45.7 x 9 cm
Handle | Mango 4.24" / 10.7 cm

ITEM #	DIM
844718	26.6" / 67 cm



Hardwood Rolling Pins

Revolving 2 3/4" / 7 cm barrel. Stainless Steel Ball Bearings.

Rodillos de madera dura

Cilindro giratorio de 7 cm (2 3/4 pulg.). Cojinetes de acero inoxidable.

ITEM #	DIM
575213	Barrel Barril 13" / 33 cm Handle Mango 3.5" / 8.9 cm

575215	Barrel Barril 15" / 38.1 cm Handle Mango 3.8" / 9.5 cm
--------	---

575218	Barrel Barril 18" / 45.7 cm Handle Mango 3.8" / 9.5 cm
--------	---



Wood Rolling Pin

Nylon Bearings. Waxed Finish.

Pasador de rodillo de madera

Rodamientos de nylon. Acabado encerado.

ITEM #	DIM
744247	Barrel Barril 10" / 25.4 cm Handle Mango 2.2" / 6 cm



Heavy Duty Nylon Spoons

Heat Resistant up to 390°F / 200°C.

Cucharas de nylon resistentes al calor

Resistentes al calor hasta 390°F / 200°C.

ITEM #	COLOR	DIM
57538203	Blue Azul	12" / 30.5 cm
57538205	Red Rojo	12" / 30.5 cm
57538503	Blue Azul	15" / 38 cm
57538505	Red Rojo	15" / 38 cm



Heat Resistant Scraper & Spoons

Silicone blades. Plastic (PP) handles.
Heat resistant up to 500° F / 260° C

Raspadores y cucharas resistentes al calor

Hojas de silicona. Mangos de plástico (PP).
Resistentes al calor hasta 500° F / 260° C.

ITEM #	DES	DIM
71772	Scraper Raspador	10.5" / 26.5 cm
71775	Scraper Raspador	14" / 35.5 cm
71778	Scraper Raspador	16.3" / 41 cm
71782	Spoon Cuchara	10.5" / 26.5 cm
71785	Spoon Cuchara	14" / 35.5 cm
71788	Spoon Cuchara	16.3" / 41 cm



Wooden Spoons

Alpine Beechwood. Large Bowl.
0.7" / 1.7 cm diameter.

Cucharas de madera

Madera de haya alpina.
Bol largo. 0.7" / 1.7 cm de diámetro.

ITEM #	FINISH ACABADO	DIM
575384	Regular Ordinaire	14" / 35.6 cm
575386	Regular Ordinaire	16" / 40.6 cm
575388	Regular Ordinaire	18" / 45.7 cm
744562	Wax finish Acabado encerado	12" / 30.5 cm
744564	Wax finish Acabado encerado	14" / 35.6 cm
744566	Wax finish Acabado encerado	16" / 40.6 cm
744568	Wax finish Acabado encerado	18" / 45.7 cm



Two-Piece Heat Resistant Scrapers

Plastic (PP). Heat-resistant up to
200°F / 93°C.

Raspadores de una pieza resistentes al calor

Plástico (PP). Mangos de plástico (PP).
Resistentes al calor hasta 200°F / 93°C.

ITEM #	DES	DIM
71771	Scraper Raspador	10.5" / 26.5 cm
71774	Scraper Raspador	14" / 35.5 cm
71777	Spoon Cuchara	16.3" / 41 cm

Nylon Pastry Bag

Made of super pliable nylon for exceptional control and feel. Simply boil for easy cleaning.

Mangas de nylon

De nylon super flexible para mayor control. Simplemente hiévalas para su fácil limpieza.

ITEM #	DIM	ITEM #	DIM
5712510	6.25 x 10" 15.9 x 25.5 cm	5712518	10 x 18" 5.4 x 45.5 cm
5712511	6.8 x 11" 17 x 28 cm	5712520	11 x 20" 27.9 x 50.8 cm
5712512	7.5 x 12" 19 x 30.5 cm	5712521	12 x 21" 30.4 x 53.5 cm
5712514	8 x 14" 20.3 x 35.5 cm	5712524	13 x 24" 33 x 61 cm
5712515	9 x 16" 22.8 x 35.5 cm	5712001	Coupling only Solo acoplamiento.
5712517	9.5 x 17" 24 x 43 cm		

Silicone Baking Mats

Ideal for all types of baking and cooking, double sided, naturally non-stick and reusable. Use in place of parchment paper or oil/grease, saving you time and cost without compromising results.

Tapetes de silicona para hornear

Ideal para todo tipo de horneado y cocción, de doble cara, naturalmente antiadherente y reutilizable. Use en lugar de papel pergamino o aceite / grasa, ahorrándole tiempo y costos sin comprometer los resultados.

ITEM #	DIM	SIZE
58182642	24.3 x 16.3" / 61.6 x 41.4 cm	Full Completo
58132642	16.5 x 11.6" / 42 x 29.5 cm	Half Mediano
58152142	20.3 x 14.4" / 51.5 x 36.5 cm	Two-Thirds Dos tercios
58131042	11.8 x 8.3" / 30 x 21 cm	One-Quarter Un cuarto

Silicone Baking Mats

- Provides consistent and even heat distribution for optimal results
- Microwave, freezer & oven safe
- Fits standard bun pans
- Food grade silicone over fiberglass reinforcement
- Temperature Range: -22°F to 446°F, -30°C to 230°C

Tapis de cuisson au silicone

- Fournissent une distribution égale et uniforme de la chaleur pour des résultats optimaux
- Vont au micro-ondes, au congélateur et au four
- Convient aux moules pain standard
- Silicone de qualité alimentaire sur renforcement en fibre de verre
- Plage de température : -22 °F à 446 °F, -30 °C à 230 °C



Thermalloy
PROFESSIONAL COOKWARE



58182640



58182632



58152140

Aluminum Bun Pan

1" / 2.5 cm Height pan. Wire-reinforced rims.

Bandejas de aluminio para hornear panecillos

Bandeja de 1" de altura. Con refuerzo de alambre en todo su perímetro a fin de evitar que se deforme.

Gauge 0.8 mm | Calibre 20

ITEM #	DIM	SIZE TAMAÑO
58182632	18 x 26" / 45.7 x 66 cm	Full Completo
58131032	9.5 x 13" / 24 x 32cm	Quarter Cuarto
58152140	15 x 21" / 38 x 53.3 cm	Two-thirds Un tercio
58100632	10 x 6" / 25.4 x 15.2 cm	One-eight Un ocho

Gauge 1.0 mm | Calibre 18

58182640	18 x 26" / 45.7 x 66 cm	Full Completo
58132640	18 x 13" / 45.7 x 33 cm	Half Mediano



Perforated Aluminum Bun Pan

1.0 mm / 18 Gauge. With perimeter reinforcing wire to resist warping. 3.0 mm diameter perforations.

Bandejas perforadas de aluminio para hornear panecillos

Con refuerzo de alambre en todo su perímetro a fin de evitar que se deforme. Perforaciones de 3.0 mm de diámetro.

ITEM #	DIM	SIZE TAMAÑO
58182641	18 x 26" / 45.7 x 66 x 2.5 cm	Full Size Completo
58132641	18 x 13" / 45.7 x 33 x 2.5 cm	Half Size Mediano

See racks on page 181
Visite la página 181 para más información sobre los racks para pan



Fully Perforated Aluminum Bun Pan

Fully perforated. 3/32" (2.3 mm) square perforation over entire pan for superior air circulation. Curled edges prevent products from sliding off. Silicone glazed interior. Wire reinforced edge. 16 gauge aluminum for durability and strength.

Bandeja para pan totalmente perforada

Totamente perforada, perforaciones cuadradas de 3/32" (2,3 mm) sobre toda la bandeja para una circulación de aire superior. Los bordes curvados evitan que los productos se deslicen. Interior esmaltado de silicona. Borde reforzado con alambre. Material de aluminio calibre 16 para una mayor durabilidad y resistencia.

ITEM #	DIM	SIZE TAMAÑO
58182651	18 x 26 x 0.98" / 45.72 x 66 x 2.5cm	Full Size Completo

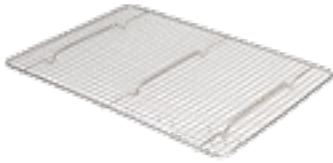

Footed Pan Grates
Nickel-plated steel wire.

Rejillas de alambre, con patas
Alambre de acero niquelado

ITEM #	DIM (W x L x D)
575516	12 x 16.5 x 1.3" 30 x 41.9 x 3.2 cm
FITS PAN SIZE PARA TAMAÑO DE RECIPIENTE 1/2 Half Mediano	
575519	24 x 16 x 1.3" 61 x 40.5 x 3.2 cm
FITS PAN SIZE PARA TAMAÑO DE RECIPIENTE 1/1 Full Completo	



Footed Pan Grates
Footed Rib Grate.

Rejillas de alambre, con patas
Rejilla con nervaduras

ITEM #	DES	DIM (W x L x D)	FITS PAN SIZE PARA TAMAÑO DE RECIPIENTE
575518	Round Redondas	12" / 30 cm	1/2 Half Mediano
575524	Rectangle Rectángulo	15 x 25" 38.1 x 63.5 cm	1/1 Full Completo
575525	Rectangle Rectángulo	17 x 25" 43.1 x 63.5 cm	1/1 Full Completo



Donut Screen
Nickel-plated steel wire.

Rejillas para donuts
Alambre de acero niquelado.

ITEM #	DIM
575517	16 x 24" 40.6 x 61 cm
FITS PAN SIZE PARA 1/1 Full Completo	



Deluxe Stainless Piano Whip

Solid handle for better balance and more sanitary. Epoxy filled for superior durability, and to help prevent contamination due to accumulation of food particles. 11 soldered wires. For beating eggs, creams and sauces.

Batidores de lujo, de alambre de piano, inoxidable

El mango sólido brinda mayor estabilidad y es más higiénico. Relleno con resina epoxy para una durabilidad superior y para ayudar a evitar la contaminación debida a la acumulación de partículas de alimentos. 11 alambres soldados.

ITEM #	DIM
571210	10" / 25.4 cm
571212	12" / 30.5 cm
571214	14" / 35.6 cm
571216	16" / 40.6 cm
571218	18" / 45.7 cm



Deluxe Stainless French Whip

Epoxy filled for a superior durability and to help prevent contamination due to accumulation of food particles. One piece welded designs prevents solid or liquid accumulation inside the handle. Solid handle for better balance and more sanitary. Stiff wires resist bending.

Batidores franceses inoxidables, de lujo

Relleno con resina epoxy para una durabilidad superior y para ayudar a evitar la contaminación debida a la acumulación de partículas de alimentos dentro del mango. Mango sólido para un mejor equilibrio e higiene. Los alambres sólidos resisten los dobleces.

ITEM #	DIM	ITEM #	DIM
571110	10" / 25.4 cm	571118	18" / 45.7 cm
571112	12" / 30.5 cm	571120	20" / 50.8 cm
571114	14" / 35.6 cm	571122	22" / 55.8 cm
571116	16" / 40.6 cm	571124	24" / 60.9 cm

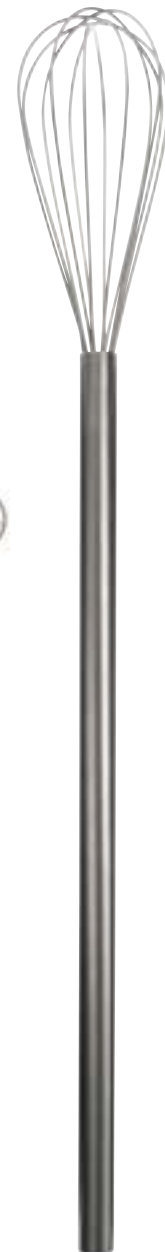

Long Handle Whips

Stainless steel. Sturdy, long handle ideal for deep mixer bowls. Ball diameter is 8 1/4" / 21 cm. Mayonnaise Whip. (Teardrop shape)

Batidores de mango largo

Mango fuerte y largo, ideal para bols para mezclar profundos. Acero inoxidable. Diámetro de la bola: 21 cm (8 1/4 pulg.).

ITEM #	DIM
571140	40" / 101.6 cm



Stainless Steel Mixing Paddles

Polished finish. 4.5 x 8" / 11.4 x 20.3 cm blade.
Hollow handles.

Paleta para mezclar

Acabado pulido.
Hoja de 4.5 x 8" / 11.4 x 20.3 cm.
Asas huecas.

ITEM #	DIM
19930	30" / 76.2 cm
19936	36" / 91.4 cm
19942	42" / 106.7 cm
19948	48" / 121.9 cm
19960	60" / 152.4 cm



Heavy Duty Stainless Steel Dough Scraper

One piece construction.

Raspador de masa para trabajo pesado

Acero inoxidable muy resistente de una

pieza.

ITEM #	DES	DIM
574263	Scraper Raspador	4.5 x 5" 11.4 x 12.7 cm



Stainless Steel Dough Scraper

With plastic handle.

Raspador de masar

Cuchilla de acero inoxidable.
Mangos de plástico (PP).

ITEM #	DIM
574268	4 x 6" 10.2 x 15.2 cm



Bowl Scrapers

Flexible Plastic. Forms easily to bowl surfaces and the firm flat edge allows for many creative uses.

Raspador de bols

Plástico flexible que se conforma fácilmente a la superficie de los bols con borde plano y firme que permite muchos usos diferentes.

ITEM #	DIM
574266	5.5 x 3.5" 14 x 8.9 cm



574264

574269

Dough Scraper

Stainless steel blade.
Hardwood handle.

Raspador de pasta

Cuchilla de acero inoxidable.
Mango de madera.

ITEM #	DIM
574264	4 x 6" / 10.2 x 15.2 cm
574269	5 x 7" / 12.7 x 17.8 cm



WHIP CREAM DISPENSERS

IDEAL FOR WHIPPING FRESH CREAM, FLAVOURED COFFEE TOPPINGS, DELICATE SAUCES, SWEET AND SAVOURY GOURMET TOPPINGS, ESPUMAS, LIGHT YOGURT MOUSSES, WHIPPED SOUPS AND MORE

DISPENSADORES DE CREMA CHANTILLY

CREMAS PARA BATIR, ADEREZOS DE CAFÉ CON SABOR, SALSAS DELICADAS, COBERTURAS GOURMET DULCES Y SALADAS DE ESTILO CHEF Y MOUSSE DE YOGUR LIGERO EN SEGUNDOS.

Stainless Steel Cream Whipper

Stainless steel.

Dispensador de crema en acero inoxidable
Construcción de acero inoxidable.

ITEM #	CAP
574409	1 Pint Pinta / 0.5 L
574410	1 QT / 1 L



Aluminum Cream Whipper

Aluminio.

Dispensador de crema en Aluminio

Aluminio.

ITEM #	CAP
574407	1 Pint Pinta / 0.5 L
574408	1 QT / 1 L





mosa[®]

WHIP CREAM DISPENSERS

YIELDS 4 TIMES THE AMOUNT
POURED INTO CREAM WHIPPER
IN SECONDS.

- Ideal for whipping fresh cream, flavoured coffee toppings, delicate sauces, sweet and savoury gourmet toppings, Espumas, light yogurt mousses, whipped soups
- Use for cold or warm ingredients, for foams or sauces

DISPENSADORES DE CREMA CHANTILLY

RINDE 4 VECES LA CANTIDAD
VERTIDA EN EL BATIDOR DE
CREMA EN SEGUNDOS.

- Ideal para montar nata fresca, toppings de café aromatizados, salsas delicadas, toppings gourmet dulces y salados, Espumas, mousses de yogur light, sopas batidas
- Mantiene la crema batida fresca en el refrigerador



Double Wall Bottle
for best insulation storage.
Keeps whipped cream fresh
in the refrigerator up
to 2 weeks.

*Botella de doble
pared,
para el mejor
almacenamiento aislante.
Mantiene la crema batida
fresca en el refrigerador hasta
2 semanas.*



Mosa Stainless Steel Cream Whipper
Stainless steel.

Dispensador Mosa de crema en acero inoxidable
Construcción de acero inoxidable.

ITEM # CAP
574355 1 Pint | Pinta / 0.5 L

574356 1 QT / 1 L



Mosa Professional Thermal Cream Whipper
All Stainless Steel. Dishwasher safe.
2 Year warranty.

Dispensador térmico Mosa de crema profesional
Construcción de acero inoxidable.
Apto para el lavavajillas.
2 años de garantía.

ITEM # CAP
574354 1 Pinta / 0.5 L

MOSA Whipped Cream Dispensers Parts

See below our extensive range of replacement parts. The Aluminum and Stainless Steel pieces are all interchangeable.

Repuestos de dispensadores de crema para Mosa

Encuentre todas sus piezas de repuesto de nuestra amplia gama con nuestro excelente servicio al cliente. Las piezas de aluminio y acero inoxidable son intercambiables.

ALUMINUM PARTS DIAGRAM DIAGRAMA DE ALUMINIO



574350-9 incluye

57 4350-5
57 4350-6
57 4350-2

STAINLESS STEEL PARTS DIAGRAM DIAGRAMA DE ACERO INOXIDABLE



574355-9 incluye

57 4350-5
57 4355-6
57 4355-2

PARTS | PARTES

ITEM #	DES	CAP	ALUMINUM ALUMINIO	STAINLESS STEEL ACERO INOXIDABLE
574350-1	Charger Holder (Blanco) Soporte del cargador (blanco)		•	
574350-2	Piston Pistó		•	
574350-5	Nozzle Adaptor (Brass nickel plated with neoprene stopper) Adaptador de boquilla latón niquelado con tapón de neopreno)		•	•
574350-6	Cap (Blanco) Tapa (blanco)		•	
574350-8	Brush Cepillo		•	•
574350-10	Bottle Recipiente	0.5 L	•	
574351-10	Bottle Recipiente	1 L	•	
574355-1	Charger Holder (Anodized) Soporte del cargador (anodizado)			•
574355-2	Piston Pistó			•
574355-3	Nozzle, Star Boquilla, estrella			•
574355-4	Nozzle, Flat Boquilla, lisa			•
574355-6	Cap (Anodized) Tapa (anodizada)			•
574355-9	Head Cabezal (includes incluye -2, -5, -6)			•
574355-10	Bottle Recipiente	0.5 L		•
574356-10	Bottle Recipiente	1 L		•



Whipped Cream Chargers
8 gr. Nitrous Oxide.

Cartuchos cargadores para crema Chantilly

Óxido de nitrógeno, 8g.

ITEM #	QTY CANT
574397	N20 Box of 10 N20 Caja de 10
574399	N20 Box of 24 N20 Caja de 24



Mosa Cream Whipper Chargers
8 gr. Nitrous Oxide.

Cartuchos cargadores para dispensadores de crema chantilly

Óxido de nitrógeno, 8g.

ITEM #	QTY QTÉ
574357	N20 Box of 10 N20 Boîte de 10
574359	N20 Box of 24 N20 Boîte de 24



Soda Syphon Chargers
8 gr. Carbon Dioxide. Box of 10.
Universal threading for any brand of dispenser.

Cartuchos cargadores de sifones de soda

Dióxido de carbono 8g, caja de 10.
Rosca universal para usar con cualquier marca de dispensador.

ITEM #	QTY CANT
574398	CO2 Box of 10 CO2 Boîte de 10



Mosa Soda Syphon Chargers
8 gr. Carbon Dioxide. Box of 10.
Universal threading for any brand of dispenser.

Cartuchos cargadores de sifones de soda
Dióxido de carbono 8g, caja de 10. Rosca universal para usar con cualquier marca de dispensador

ITEM #	QTY QTÉ
574358	CO2 Box of 10 CO2 Boîte de 10

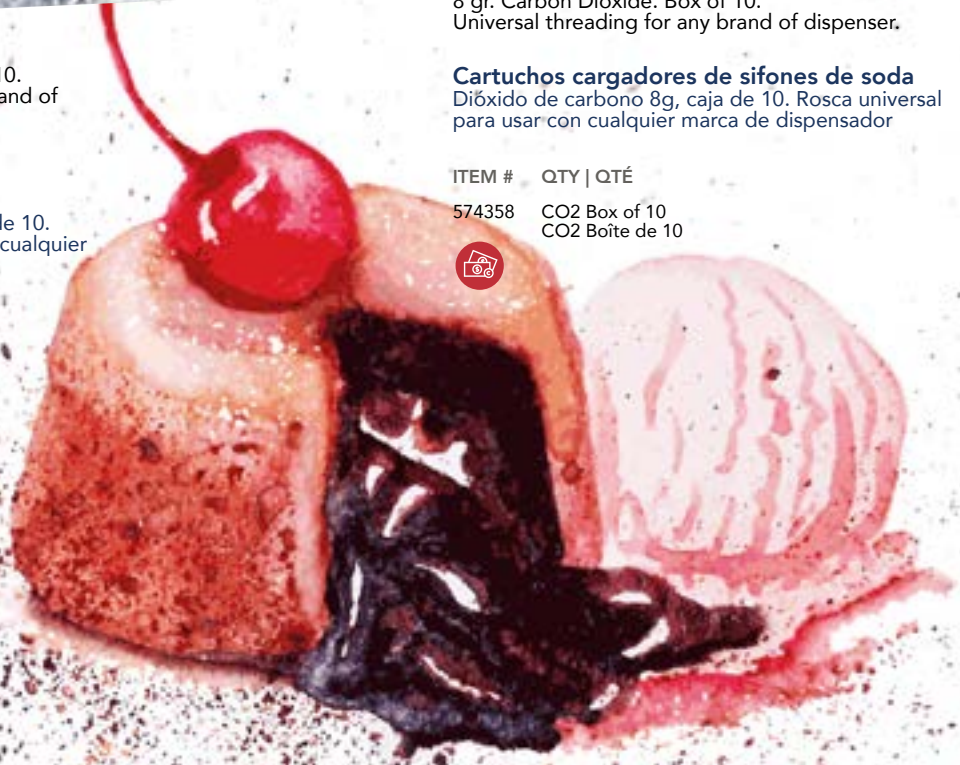

80880101



80880001



Pastry Cutters

Eight (8) piece set. Stainless steel. Stores in a round, translucent container.

Ring sizes:

1.2, 1.6, 2, 2.4, 2.75, 3.1, 3.5, 4"

3, 4, 5, 6, 7, 8, 9, 10 cm

Cortadores para pastelería

Set de ocho (8) piezas. Construcción de acero inoxidable. Se almacena en un contenedor Rojoondo y translúcido.

Tamaños:

1.2, 1.6, 2, 2.4, 2.75, 3.1, 3.5, 4"

3, 4, 5, 6, 7, 8, 9, 10 cm

ITEM #	DES	DIM
80880101	Plain Liso	1.2 - 4" / 3 - 10 cm
80880001	Fluted Estriado	1.2 - 4" / 3 - 10 cm



Stainless Steel 6-Wheel Dough Cutter

Sharp stainless steel wheels. Nickel-plated steel frame. Adjustable up to 24.1" / 61.2 cm fully open.

Cortadores para pastelería

Ruedas de acero inoxidable filosas. Estructura de acero niquelado. Ajustable, se abre completamente hasta 61.2 cm (24.1 pulg.)

ITEM #	DIA
2226	2" / 6.35 cm



Polyethylene Funnels

One-piece, seamless.

Embudos de polietileno

Una pieza, sin costura.

ITEM #	CAP	DIM
368	8 oz / 236 ml	4.1" / 10.5 cm
369	16 oz / 473 ml	5.3" / 13.5 cm
370	32 oz / 945 ml	6.3" / 16 cm



Aluminum Scoops

Die-cast aluminum. Highly polished inside and outside. Handle has grooved finish with finger grip to prevent slipping

Palas de aluminio

Aluminio fundido. Altamente pulidas por dentro y fuera. El mango tiene acabado estriado con ranuras para los dedos a fin de evitar que se resbalen. Fondo Rojoondeado.

ITEM #	CAP	DIM
575400	5 oz / 150 ml	4.8 x 2.4" / 12.1 x 6 cm
575401	12 oz / 350 ml	6.8 x 3.1" / 15.9 x 13 cm
575402	24 oz / 710 ml	8 x 4" / 20.3 x 10.2 cm
575403	38.8 oz / 1.1 L	9 x 4.8" / 22.9 x 12.1 cm
575404	57.5 oz / 1.7 L	10.5 x 5.5" / 26.7 x 14 cm
575405	84.5 oz / 2.5 L	12 x 6.8" / 30.5 x 15.9 cm



Aluminum Scoops

Flat bottom. Cast Aluminum.

Palas de aluminio

Fondo plano. Aluminio fundido.

ITEM #	CAP	DIM
574250	1 oz / 30 ml	4.3" / 11 cm
574251	2 oz / 60 ml	5.8" / 14.7 cm
574252	4 oz / 118 ml	8.3" / 21 cm
574253	7 oz / 207 ml	9.8" / 25 cm
574254	16 oz / 473 ml	12.3" / 31 cm
574255	24 oz / 710 ml	14" / 35.6 cm



Plastic Scoops

White. Flat bottom. One-piece construction. Dishwasher safe. Non-toxic. Ideal for ice bins.

Pala de plástico

Blanca. Fondo plano. Construcción de una pieza. Se puede lavar en el lavavajillas. Material no tóxico. Ideal para hielo.

ITEM #	CAP
574873	64 oz / 1.9L



Use it as your plating brush

Úselo como su cepillo de recubrimiento



Pastry Basting Brushes

Boar bristles. Plastic handle. ABS plastic band. With a heat tolerance up to 248°F/120°C, perfect for basting and egg washing. Dishwasher safe.

Brochas para repostería

Cerdas de jabalí. Manija de plástico. Banda de plástico ABS. Con una tolerancia al calor de hasta 248 °F/120 °C, perfecto para rociar y lavar huevos. Apta para lavavajillas.

ITEM #	DES	DIA
61300-1	Round Ovales	1" / 2.5 cm
6130015	Linear Plats	1.5" / 3.8 cm
61300-2	Linear Plats	2" / 5 cm
61300-3	Linear Plats	3" / 7.6 cm

Pastry Brushes
Pinceles sellados para pastelería

Boar bristles. Wood handle. ABS plastic band.
Cerdas de jabalí. Mango de madera.
Banda de plástico ABS.

ITEM #	DES	DIA
61200	Oval Ovolo	1" / 2.5 cm
61200-1	Flat Planos	1" / 2.5 cm
6120015	Flat Planos	1.5" / 3.8 cm
61200-2	Flat Planos	2" / 5 cm
61200-3	Flat Planos	3" / 7.6 cm



Boar bristles. Wood handle.
Cerdas de jabalí. Mango de madera.

ITEM #	DES	DIA
61100	Oval Ovolo	1" / 2.5 cm
HL9115W	Flat Planos	1" / 2.5 cm
HL9116W	Flat Planos	1.5" / 3.8 cm
HL9117W	Flat Planos	2" / 5 cm
HL9118W	Flat Planos	2.5" / 6.4 cm
HL9119W	Flat Planos	3" / 7.6 cm



Spring Form Cake Pans
Highly polished tin.

Moldes de torta desfondables
Estaño altamente pulido.

ITEM #	DIM (DIA X DEPTH PROF)
746070	7 x 2.5" / 18 x 6.4 cm
746071	8 x 2.5" / 20.3 x 6.4 cm
746073	9 x 2.5" / 23 x 6.4 cm
746074	10 x 2.5" / 25.5 x 6.4 cm
746075	11 x 2.75" / 28 x 7 cm



Spring Form Cake Pans
Highly polished tin.

Molde de torta profundo desfondable
Estaño altamente pulido.

ITEM #	DIM (DIA X DEPTH PROF)
746060	7 x 3.8" / 18 x 9.5 cm
746061	8 x 3.8" / 20 x 9.5 cm
746063	9.5 x 3.8" / 23 x 9.5 cm



Non-Stick Spring Form Cake Pans
Coated tin.

Moldes de torta desfondables antiadherentes
Estaño revestido.

ITEM #	DIM (DIA X DEPTH PROF)
746080	7 x 2.5" / 18 x 6 cm
746081	8 x 2.5" / 20 x 6 cm
746083	9 x 2.5" / 23 x 6 cm
746084	10 x 2.5" / 25.5 x 6 cm
746085	11 x 2.5" / 28 x 6 cm

Pie Cutter |
Cortadores de tartas

Stainless Steel Pie Cutter Cortadores de tartas

ITEM #	CUT CORTES
575116	6
575117	7
575118	8

Pie Marker |
Marcadores de tartas

Pie Marker
Cast aluminum. Polished finish.
Good for any diameter of pie.

Marcadores de tartas
Aluminio fundido. Acabado pulido. Para tartas de diferentes diámetros.

ITEM #	CUT CORTES
575105	5
575106	6
575107	7
575108	8
575110	10
575112	12



Stainless Steel Rim Sieve
16 mesh wire with two cross-bar wire reinforcers. 2.8" / 7 cm height.

Cedazos con borde de acero inoxidable
16 cables de malla con dos refuerzos de alambre de barra cruzada. 2.8" / 7 cm de altura.

ITEM #	DIA
574142	12" / 31 cm
574144	14" / 36 cm
574146	16" / 41 cm



Stainless Steel Tart Rings
Rolled edges.
Height: 3/4" / 2 cm

Cedazos para tarta de acero inoxidable
Bordes rodados.
Altura: 3/4" / 2cm

ITEM #	DIA
80824920	3" / 8 cm
80824940	4" / 10 cm
80824944	7" / 18 cm
80824960	8.7" / 22 cm



575328

575329

Aluminum Pie Plate
0.75mm (.030") Thickness.
Height is 1.3" / 3 cm.

Tarteras de aluminio
0.75mm (0.030") de espesor.
Altura de 1.3" / 3 cm.

ITEM #	DIA
575328	8" / 20 cm
575329	9" / 23 cm
575330	10" / 25.5 cm



Aluminum Muffin Pan
Heavy Duty Aluminum. Cups are 13/16" / 3 cm deep, permanently seamed in frame.
Frame 1.6 mm. Cups 0.6 mm.
3 oz capacity.
Top Cup: 2.8" / 7 cm
Bottom Cup: 2" / 5.1 cm

Moldes de muffin / pastelitos en forma de taza
Construcción de aluminio muy resistente. Tazas de 3 cm / 1 3/16 pulg. de profundidad adosadas al marco de forma permanente. 3 oz de capacidad.
Taza superior: 2.8" / 7 cm
Taza inferior: 2" / 5.1 cm

ITEM #	CUPS TAZAS	DIA
5811612	12	10.8 x 14.1 x 1.2" 27.3 x 35.5 x 3 cm
5811624	24	20.6" x 14.1" x 1.2" 52.4 x 35.5 x 3 cm



Loaf Pan
Heavy tin steel.
3" / 7.6 cm height.

Molde para pan
Acero de latón pesado
3" / 7.6 cm de altura.

ITEM #	DIM
746050	8" / 20 cm
746051	9" / 23 cm
746052	12" / 30.5 cm



Cake Cover / Handle / Base

One-piece, durable lucite cover with chrome handle.
6.4" / 16.2 cm height.

Campana para torta o pastel / Platón / Base baja

Campana de lucita durable, de una pieza con mango de cromo. 6.4 / 16.2 cm de altura.

ITEM #	DES
57140	Cover Campana 12 x 6.4" / 30.5 x 16.2 cm
57140-1	Handle Mango
57125	Cake Stand Platón 12 x 7.2" / 30.5 x 18.1 cm
57124	Low base stand Base Baja 12" / 30.5 cm diameter diámetro

See page 79
for our NEW
Tabletop
Dinnerware

Consulte la
página 79
para nuestra
NUEVA vajilla
de mesas



Aluminum Dry Measures

Seamless construction. Large riveted handles. Capacity markings. 1.8 mm thickness.

Medidores de productos secos

Aluminio. Construcción sin costuras. Asas grandes remachadas. Marcas de capacidades. 10.8 mm de espesor.

ITEM #	CAP	DIA	ITEM #	CAP	DIA
575605	0.5 QT / 0.5 L	4.3 x 3.9" 10.8 x 9.8 cm	575620	2 QT / 1.9 L	6.1 x 6.7" 15.6 x 16.8 cm
575610	1 QT / 0.9 L	5.3 x 5.3" 13 x 13 cm	575640	4 QT / 3.8 L	7.4 x 8.5" 18.7 x 21.6 cm



Aluminum Liquid Measures

Seamless construction. Large riveted handles. Capacity markings. Designed for no-spill pouring. 1.8 mm thickness.

Medidores de líquidos

Aluminio. Construcción sin costuras. Asas grandes remachadas. Marcas de capacidades. Diseñados para verter líquidos sin derramar. 10.8 mm de espesor.

ITEM #	CAP	DIA	ITEM #	CAP	DIA
575645	0.5 QT / 0.5 L	4.3 x 3.9" 10.8 x 9.8 cm	575660	2 QT / 1.9 L	6.1 x 6.7" 15.6 x 16.8 cm
575650	1 QT / 0.9 L	5.3 x 5.3" 13 x 13 cm	575670	4 QT / 3.8 L	7.4 x 8.5" 18.7 x 21.6 cm



Stainless Steel Dredge

Polished finish. Universal holes. Diameter: 2.75" / 7 cm

Espolvoreadores de acero inoxidable

Acabado pulido. Perforaciones universales. Diámetro: 2.75" / 7 cm

Without handle | Sin mango

ITEM #	DIA (HOLES AGUJEROS)	CAP	DIM (H)
575698	1.9 mm	12 oz / 355 ml	3.88" / 9.86 cm
575672	3.9 mm	12 oz / 355 ml	3.88" / 9.86 cm
575673	1.9 mm	16 oz / 473 ml	5.5" / 13.97 cm
575675	1.9 mm	22 oz / 650 ml	7.5" / 19.05 cm

With handle | Con mango

ITEM #	DIA (HOLES AGUJEROS)	CAP	DIM (H)
575699	1.9 mm	12 oz / 355 ml	3.88" / 9.86 cm
575674	1.9 mm	16 oz / 473 ml	5.5" / 13.97 cm



Plastic Dredge Set

Tough polycarbonate construction. Comes with 3 lids (fine, medium and large holes). 10 oz / 300 ml capacity.

Juego de espolvoreadores de plástico

Construcción resistente de policarbonato. Viene con 3 tapas (agujeros finos, medianos y grandes). 10 oz / 300 ml de capacidad.

ITEM #	DIA
575680	2.5 x 3.7" / 6.4 x 9.2 cm



Aluminum Dredge

Satin finish. Universal holes.

Espolvoreadores de aluminio

Acabado satinado. Perforaciones universales.

Without handle | Sin mango

ITEM #	DIA
575681	2.8 x 4" 7 x 10.2 cm

With handle | Con mango

ITEM #	DIA
575671	2.5 x 3.7" 6.4 x 9.2 cm
575682	2.8 x 4" 7 x 10.2 cm





Cuisipro.

STAINLESS STEEL MEASURING CUPS & SPOONS

- Each comes with convenient storage ring to keep them together
- Thick, flat rims make it easy to level your cups with a straight edge
- Gently curved handles allow the spoons to sit securely on the counter without tipping over
- Welded one-piece construction

TAZAS Y CUCHARAS DE MEDICIÓN DE ACERO INOXIDABLE

- Cada set de taza y cuchara de medición viene con un conveniente anillo para mantener las piezas juntas
- Sus bordes gruesos y planos facilitan la nivelación al ras
- Las asas ligeramente curvas permiten que las cucharas se asienten firmemente sobre el mostrador sin volcarse
- Construcción soldada de una sola pieza



Measuring Cups
Cuisipro. Stainless steel.
1/4, 1/3, 1/2 and 1 cup

Tazas medidoras
Cuisipro. Acero inoxidable.
1/4, 1/3, 1/2 y 1 taza.

ITEM #
747141

Measuring Spoons
Cuisipro. Stainless steel.
1/8, 1/4, 1/2, 1 teaspoon,
and 1 tablespoon.

Cucharas medidoras
Cuisipro. Construcción de acero
inoxidable. 1/8, 1/4, 1/2, 1 cucharita,
y 1 cuchara

ITEM #
747002



Stainless Steel Measuring Cup Set (4)
Graduated inside and out. 4pc. Set includes 1/4 cup, 1/3 cup, 1/2 cup and 1 cup.

Set de tazas medidoras de acero inoxidable (4)
Graduado por dentro y por fuera. 4 piezas El juego incluye 1/4 de taza, 1/3 de taza, 1/2 taza y 1 taza.

ITEM #	DES
746107	With solid handles Con mangos sólidos
746106	With loop handles Con mangos huecos



Stainless Steel Measuring Spoon Sets Juegos de cucharas para medir

ITEM #	FINISH	DES
746108	Stainless steel Acero inoxidable	4 pieces: 1/4 tsp, 1/2 tsp, 1 tsp and 1 tbsp 4 piezas: 1/4 c. à cucharita,, 1/2 c. à cucharita,, 1 c. à cucharita, t 1 cuchara
746105	18/8 stainless steel Acero inoxidable 18/8	5 pieces: 1/8 tsp, 1/4 tsp, 1/2 tsp, 1 tsp and 1 tbsp. 5 piezas: 1/8 c. à cucharita, 1/4 c. à cucharita, 1/2 c. à cucharita, 1 tsp et 1 cuchara.
2316EH	Extra heavy stainless steel Acier inoxydable extra fort	4 pieces: 1/4 tsp, 1/2 tsp, 1 tsp and 1 tbsp. 4 piezas: 1/4 c. à cucharita, 1/2 c. à cucharita, 1 tsp et 1 cuchara.

8 Cup Stainless Steel Flour Sifter
18/8 stainless steel. Polished body,
handle and 16 mesh (squares per inch)
screen. Chrome-plated beater with wire
reinforcement on bottom.



Cedazo para harina de acero inoxidable

Acero inoxidable 18/8. Cuerpo pulido,
mango y malla con trama de 16 cuadrados
por pulgada. Batidor cromado con refuerzo
de alambre en el fondo.

ITEM #	DIA
1260	6 x 6.5" / 15.2 x 16.5 cm



FRANCE 1887

GOBEL®

la référence des pâtisseries

PASTRY MOULD

MANUFACTURING PASTRY
MOULDS SINCE 1887

MOLDES DE PASTELERÍA

FABRICACIÓN DE MOLDES
DE PASTELERÍA DESDE 1887



Fluted Tartelette Molds
Tin plated steel.

Moldes de tartaletas aflautados
Estañado.

ITEM #	DIA	FINISH/ ACABADO
80293570	3.9" / 10 cm	Non-stick Antiadherente
80193530	2.4" / 6 cm	Regular Ordinaires
80193550	3.1" / 8 cm	Regular Ordinaires
80193560	3.5" / 9 cm	Regular Ordinaires
80193570	3.9" / 10 cm	Regular Ordinaires



Brioche Molds
Flat bottom.

Moldes de brioche
Fondo plano.

ITEM #	DIA
Small. Tinned. Fluted. Estañado. Pequeño, acanalado.	
80193710	2.5" / 6 cm
80193720	2.8" / 7 cm
80193730	3" / 7.5 cm
80193740	3.1" / 8 cm
80193750	3.5" / 9 cm
80193760	3.9" / 10 cm

Non-stick. Large. 14 wide ribs. Coated Steel.
Grande. 14 nervaduras anchas. Acero recubierto.

80223010	5.5" / 14 cm
80223020	6.3" / 16 cm



Boat Tartlet Molds
Plain. Tin plated steel.

Moldes de tartaletas
Planos. Estañado.

ITEM #	DIA
80194030	3.1" / 8 cm
80194040	3.5" / 9 cm
80194050	3.9" / 10 cm
80194060	4.3" / 11 cm
80194070	4.7" / 12 cm

Folding Loaf Pan
Heavy tin steel.

Molde plegable para pan
Acero de latón pesado.

ITEM #	DIA
80120020	11 x 4 x 3" 27 x 10 x 7.5 cm



Quiche Pans

Tin plated steel. Removable bottom.

Moldes para torta

Estañado. Fondo extraíble.

ITEM #	DIA	HEIGHT ALTO
80126420	7.8" / 20 cm	1" / 2.5 cm
80126430	9.5" / 24 cm	1" / 2.5 cm
80126432	10" / 26 cm	1" / 2.5 cm
80126440	11" / 28 cm	1" / 2.5 cm



Quiche Pans

Tin plated steel. Removable bottom.

Moldes para tarta

Estañado. Fondo extraíble.

ITEM #	DIA	HEIGHT ALTO
80126620	8" / 20 cm	1.2" / 3 cm
80126640	11" / 28 cm	1.2" / 3 cm
80124810*	4" / 10 cm	1.8" / 4.5 cm
80124840**	10" / 25 cm	2.3" / 5.7 cm



Non-Stick Quiche Pans

Removable bottom. Coated steel.

Moldes para tarta antiadherentes

Fondo extraíble. Acero recubierto.

ITEM #	DIA	HEIGHT ALTO
80293480	4.8" / 12 cm	0.75" / 2 cm



Madeleine Sheet

Tinned.

Molde para magdalenas

Estañado.

ITEM #	DIA
80164710	12 x 3" / 30.5 x 8 cm



THERMOMETERS

FEATURE 304 STAINLESS STEEL CASE OR PARTS AND ACCURACY OF +/- 1 TO 2°F. ANTIMICROBIAL PROTECTION. SOME DIALS ARE DUAL FACE.

TERMÓMETRO

ACERO INOXIDABLE 304 Y UNA EXACTITUD DE +/- 1 A 2°F. PROTECCION CONTRA LAS BACTERIAS. ALGUNOS DIALES TIENEN DOBLE ESCALA.



Candy / Deep Fry Thermometer
Adjustable pan clip. Dishwasher safe.
2.1" / 5.4 cm diameter dial.
Temperature range: 50°F to 550°F,
10°C to 288°C

Termómetro para caramelos / frituras
Clip ajustable para la cacerola. Se puede lavar en el avavajillas.
2.1" / 5.4 cm de diámetro del dial.
Rango de temperatura:
50°F a 550°F / 10 °C a 288 °C

ITEM #	DIM
CT84119	8" / 20.3 cm
CT84122	12" / 30.5 cm

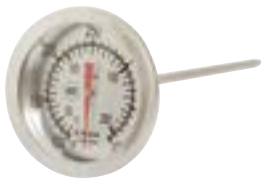

Candy / Jelly / Deep Fry Thermometer
Dual face. Accuracy of +/-1°F.
Adjustable pan clip. Dishwasher safe.
2.3" / 5.7 cm diameter dial.
6.3" / 15.8 cm height.

Termómetro para caramelos / jaleas / fritos
Doble escala. Exactitud de +/-1°F.
Mango resistente al calor. Clip ajustable para la cacerola. Se puede lavar en el lavavajillas. 2.3" / 5.7 cm de diámetro del dial 6.3" / 15.8 cm de altura.

ITEM #	RANGE/RANGO
CT84004	100 °F - 400 °F 37 °C - 204 °C



Candy / Deep Fry Thermometer
Adjustable pan clip. Dishwasher safe.
2.1" / 5.4 cm diameter dial.
Temperature range: 100°F to 400°F /
37°C to 204°C.

Termómetro para caramelos / frituras
Clip ajustable para la cacerola. Se puede lavar en el lavavajillas. 2.1" / 5.4 cm de diámetro del dial. Rango de temperatura:
100 °F a 400 °F / 37 °C a 204 °C

ITEM #	DIM (LXW)
CT84031	4.9 x 1.3" / 12.4 x 3.2 cm



Pocket Test Thermometer
Bezel and pointed stem. Protective storage case with pocket clip. Accuracy of +/-1°F. Not for oven use. 1" / 2.5 cm diameter dial. 5" / 12.7 cm overall length.

Termómetros de bolsillo para verificar la temperatura de los alimentos
Engaste y vara puntiaguda. Estuche protector con clip para el bolsillo. Exactitud de +/- 1°F. No deben usarse en el horno.

ITEM #	RANGE / RANGO
PT84101	0°F - 220°F / 18°C - 104°C
PT84104	50°F - 550°F / 10°C - 288°C
PT84113	14°F - 230°F / 10°C - 110°C





Refrigerator Thermometer

Dual face. Stands. Accuracy of +/- 2°F. Dishwasher safe.

Termómetro para refrigerador/congelador

Doble escala. Se descansa sobre una superficie. Exactitud de +/- 2°F. Se puede lavar en el lavavajillas.

ITEM #	RANGE RANGO	DIM (DIAL DIA X H) DIÁMETRO DEL DIAL
RT84019	- 30 °F - 70 °F - 35 °C - 21 °C	2.4" x 2.4" 6 x 6 cm



Freezer Thermometer

Dual face. Stands. Accuracy of +/- 2°F. Dishwasher safe. 2.4" / 6 cm diameter dial. 3.8" / 9.5 cm height.

Termómetro para congelador

Doble escala. Se descansa sobre una superficie. Exactitud de +/- 2°F. Se puede lavar en el lavavajillas. 2.4" / 6 cm de diámetro de dial. 3.8" / 9.5 cm de altura.

ITEM #	RANGE RANGO	DIM (DIAL DIA X H) DIÁMETRO DEL DIAL
RT84016	- 20 °F - 80 °F - 30 °C - 30 °C	2.4" x 3.8" 6 x 9.5 cm



Hanging Thermometer

Dual face. Hangs or stands. Extra wide base. Accuracy of +/- 1°F. Dishwasher safe. For oven use. 2.4" / 6 cm diameter dial. 3.8" / 9.5 cm overall length.

Termómetro colgante para horno

Doble escala. Se cuelga o se descansa sobre una superficie. Base extra ancha. Exactitud de +/- 1°F. Se puede lavar en el lavavajillas. Certificación NSF. 2.4" / 6 cm de diámetro del dial 3.8" / 9.5 cm de largo total.

ITEM #	RANGE RANGO	DIM (DIAL DIA X H) DIÁMETRO DEL DIAL
OT84010	150 °F - 550 °F - 65.6 °C - 287.8 °C	2.4" x 3.8" 6 x 9.5 cm



Dial Meat Thermometer

Dual face. Pointed stem. Accuracy +/- 1°F. Dishwasher safe. 2.4" / 7 cm diameter dial. 5" / 12.7 cm overall length.



Termómetro de dial para carne

Doble escala. Vara puntiaguda. Exactitud de +/- 1°F. Se puede lavar en el lavavajillas. 2.4" / 7 cm de diámetro del dial 5" / 12.7 cm de largo total.

ITEM #	RANGE/RANGO
MT84001	120 °F - 220 °F 49 °C - 104 °C



NEW
NUEVO

Digital Pocket Thermometer

Perfect for thin cuts of meat, fish or poultry. 2.75" / 7.0 cm stainless steel stem. Waterproof. Shatterproof. Auto shut-off after 20 minutes. Sheath can be used as handle extension, includes storage case with pocket clip. Batteries included.

Termómetro digital de bolsillo

Perfecto para cortes finos de carne, pescado o aves. Vástago de acero inoxidable de 2,75" / 7,0 cm. Impermeable. Inastillable. Apagado automático después de 20 minutos. La funda se puede utilizar como extensión del mango, incluye estuche de almacenamiento con clip de bolsillo. Baterías incluidas.

ITEM #	RANGE/RANGO	TIP
84116	-40°F to 450° F / -40°C to 230°C	2.5 mm
84120	-40°F to 450° F / -40°C to 230°C	1.5 mm



Hanging Refrigerator & Freezer Thermometer

Dual face. Hangs or stands. Accuracy of +/- 2°F. Dishwasher safe. Rust proof. NSF listed. Temperature range: 40°F to 80°F / -40°C to 27°C



Termómetro colgante de refrigerador y congelador

Cara doble. Se cuelga o se para. Precisión de +/- 2 °F. Apto para el lavavajillas. A prueba de óxido. Listado por NSF. Rango de temperatura: -40 °F a 80 °F / -40 °C a 27 °C

ITEM #	DIM (LXW)
FT84028	1.9 x 12" / 4.7 x 30.5 cm



Minute Timer Cronómetro con capacidad para una hora de tiempo

1-hour timing capacity. Long ring. Insistent ring up to 18 seconds | Un solo timbre. Timbre de larga duración y persistente, hasta 18 segundos.

ITEM #	DIM (LXW)
571929	2.8" / 7.1cm

1-hour timing capacity. Single ring. | Un solo timbre. Timbre individual.

ITEM #	DIM (LXW)
572428	2.5" / 6.3 cm



Thermalloy
PROFESSIONAL COOKWARE



DEEP DISH PIZZA PAN

IDEAL FOR BAKING
AND SERVING DEEP
DISH PIZZAS

- Seamless rim construction
- Natural finish
- Straight sides
- Care: handwash only

BANDEJA HONDA PARA PIZZA ESTILO CHICAGO

IDEAL PARA HORNEAR Y
SERVIR PIZZAS ESTILO
CHICAGO.

- Diseño de borde sin costuras
- Acabado natural
- Lados rectos
- Cuidados: solo lavar a mano

Deep Dish Pizza Pan

18 Gauge.1.0mm. 1" / 2.5cm height. Aluminum.

Moule à pizza épaisse

Calibre de 18, 1,0 mm. Hauteur de 1 po/2,5 cm. Aluminium.

ITEM #	DIM	ITEM #	DIM
5730066	6" / 15.2cm	5730073	13" / 33cm
5730067	7" / 17.8cm	5730074	14" / 35.6cm
5730068	8" / 20.3cm	5730075	15" / 38.1cm
5730069	9" / 22.9cm	5730076	16" / 40.6cm
5730070	10" / 25.4cm	5730077	17" / 43.2cm
5730071	11" / 27.9cm	5730078	18" / 45.7cm
5730072	12" / 30.5cm		



Seamless Rims
Construction

Construcción
de bordes
sin uniones



Aluminum Pizza Screens

18 Gauge. 1.0 mm. Seamless rim construction. Produces evenly baked crust by allowing air to circulate beneath crust while baking.

Rejillas de aluminio para pizza

1.0mm, calibre 19. Orilla sin juntas. La corteza se cocina de manera pareja porque el aire circula por debajo durante el horneado.

ITEM #	DIM	ITEM #	DIM
575377	7" / 17.8 cm	575364	14" / 35.6 cm
575378	8" / 20.3 cm	575365	15" / 38.1 cm
575379	9" / 22.8 cm	575366	16" / 40.6 cm
575360	10" / 25.4 cm	575367	17" / 43.2 cm
575361	11" / 28 cm	575368	18" / 45.7 cm
575362	12" / 30.5 cm	PS19	19" / 48 cm
575363	13" / 33 cm	PS20	20" / 50.8 cm

**Professional Aluminum
Pizza Coupe Plates**
18 Gauge. 1.0mm. Heavy Weight.

**Platos de aluminio
para pizza, profesionales**
1.0 mm, calibre 18.

ITEM #	DIM
575307	7" / 17.8 cm
575308	8" / 20.3 cm
575309	9" / 22.8 cm
575310	10" / 25.4 cm
575311	11" / 28 cm
575312	12" / 30.5 cm
575313	13" / 33 cm
575314	14" / 35.6 cm
575315	15" / 38.1 cm
575316	16" / 40.6 cm
575317	17" / 43.2 cm
575318	18" / 45.7 cm
575319	19" / 48 cm
575320	20" / 50.8 cm

**Aluminum Perforated
Pizza Trays**
18 Gauge. 1.0 mm. Pizza bottom
cooks faster and makes crispier crust.

Pizzeras perforadas de aluminio
1.0 mm, calibre 18.
La corteza de la pizza se cocina
más rápido y queda más crocante.

ITEM #	DIM
575347	7" / 17.8 cm
575348	8" / 20.3 cm
575349	9" / 22.8 cm
575350	10" / 25.4 cm
575351	11" / 28 cm
575352	12" / 30.5 cm
575353	13" / 33 cm
575354	14" / 35.6 cm
575355	15" / 38.1 cm
575356	16" / 40.6 cm
575357	17" / 43.2 cm
575358	18" / 45.7 cm
575359	19" / 48 cm

Aluminum Wide Rim Pizza Pans
18 Gauge. 1.0 mm. Natural finish.
Beaded edge.

**Pizzeras de aluminio
con borde ancho**
1.0 mm, calibre 18. Acabado natural.
Reborde con bolitas.

ITEM #	DIM
5730026	6" / 15.2 cm
5730027	7" / 17.8 cm
5730028	8" / 20.3 cm
5730029	9" / 22.8 cm
5730030	10" / 25.4 cm
5730031	11" / 28 cm
5730032	12" / 30.5 cm
5730033	13" / 33 cm
5730034	14" / 35.6 cm
5730035	15" / 38.1 cm
5730036	16" / 40.6 cm
5730037	17" / 43.2 cm
5730038	18" / 45.7 cm





Pizza Paddle
Two-sided design with a combination of 5 sizes for optimal usage. Measurement grooves of 12" and 16" on one side. Measurement grooves of 10", 14" and 18" on the other side. Heat resistance up to 350°F. Made with ecofriendly fibre composite.

Pelle à pizza
Diseño reversible con una combinación de 5 tamaños para un uso óptimo. Rainures de mesure de 12" et 16" d'un côté. Rainures de mesure de 10", 14" et 18" de l'autre côté. Fabriqué avec une composite de fibre écologique.

ITEM # DIM
575376 19.5" / 49.5 cm



Wooden Pizza Peels
Made of finest seasoned lumber. Blade tapers at tip and sides.

Paletas de madera para pizza
Madera estacionada de calidad superior. La cuchilla se afina en la punta y a los lados.

ITEM #	DIM (BLADE LAME)	OVERALL LENGTH LARGO
5116 Short handle Mango corto	12 x 14" 30.5 x 35.6 cm	22" 55.9 cm
5117 Short handle Mango corto	14 x 17" 35.6 x 43.2 cm	24" 60.9 cm
5316 Long handle Mango largo	16 x 18" 40.6 x 45.7 cm	36" 91.4 cm



Deluxe Pizza Peels
Hardwood handle with two attachment screws and riveted aluminum blade.

Paleta estándar para pizza
Mango de madera dura con hoja remachada de aluminio.

ITEM #	DIM (BLADE LAME)	OVERALL LENGTH LARGO
575322	12 x 12.5" 30.5 x 31.75 cm	33.5" / 85 cm
575324	14 x 14.5" 35.5 x 36.8 cm	35.5" / 90 cm
575326	16 x 16.5" 40.6 x 42 cm	37.5" / 95.25 cm



Pizza Peels
Hardwood handle with riveted aluminium blade.

Paletas para pizza
Mango de madera dura con hoja remachada de aluminio.

ITEM #	DIM (BLADE LAME)	OVERALL LENGTH LARGO
23501	12" 30.5 cm	26.5" 67.3 cm
23506	12" 30.5 cm	35.5" 90.2 cm
23516	12" 30.5 cm	42.5" 107.9 cm



Cuisipro.

Pizza Peel
Fibre wood. Natural.

Pala para pizza
Madera de fibra. Natural.

ITEM #	OVERALL LENGTH LARGO
74791400	21" x 13" x 0.25"



Pizza Cutter

Hardwood lacquered handle.
Sanitary stainless steel wheel.
Finger guard for safety.

Cortadores de pizza

Mango lacado de madera. Rueda de acero inoxidable sanitario. Protector de dedos para mayor seguridad.

ITEM #	BLADE LENGTH LARGO DE LA HOJA
574262	4 x 9" 10.2 x 22.9 cm



Pizza Cutter

Sanitary stainless steel wheel. Finger guard for safety. Polypropylene handle.

Cortadores de pizza

Rueda de acero inoxidable sanitario. Protector de dedos para mayor seguridad.

ITEM #	WHEEL DIA DÍA. DE LA RUEDA	LENGTH LARGO
5744261	2.5" / 6.4 cm	7" / 17.8 cm
5744262	4" / 10.2 cm	9.3" / 23.5 cm



Plastic Roller Docker

Simply roll the docker wheel to perforate your dough before baking. Seamless joint between pins and roller base for easy cleaning. 64 pins. Distance between pins is 5/8"/1.5 cm.

Rodillo para amasar con clavijas

Juntas sin costuras entre las clavijas y la base del rodillo, para su fácil limpieza. 64 clavijas, Distance between pins is 5/8"/1.5 cm.

ITEM #	PIN LENGTH LARGO DE LA CLAVIJA	DIM
574265	0.88" / 2.2 cm	2.5" / 6.3 cm



Pan Gripper for Dish Pans

Nickel-plated. Self locking design. Pan load activates clamping action. 60° angle.

Sujetador de pizzera

Niquelado. Con mecanismo para cerrar. El peso de la pizzera activa el sujetador.

ITEM #	BASE
PG1	7.5" / 19.1 cm



Square Grater

Stainless steel. Four different surfaces: coarse and medium shredder, slicer and julienne cuts.

Rallador cuadrado

Acero inoxidable. Cuatro superficies de rallado diferentes: desmenuzador y rebanador grueso, mediano y fino.

ITEM #	DIA
5753300	9 x 4 x 4" 23 x 10 x 10 cm



746127

3199

Box Grater

Stainless steel. Four different surfaces: coarse and medium shredder, slicer and julienne cuts.

Rallador rectangular

Acero inoxidable. Cuatro superficies de rallado diferentes: desmenuzador y rebanador grueso, mediano y fino.

ITEM #	DIA
746127	9.5 x 4" x 3" 24 x 10 x 7.5 cm
3199	9 x 4 x 3" 23 x 10 x 7.5 cm



6-Sided Grater

Stainless steel, extra fine, fine, medium, coarse graters, julienne and slicer.

Rallador de 6 lados

Acero inoxidable, extra fino, fino, mediano, ralladores gruesos, juliana y rebanador.

ITEM #	DIA
746124	9.5" / 24 cm



Cheese Grater Rotary

Stainless Steel. For right and left handed use. Drum is 1.75" / 4.4 cm wide.

Rallador de queso giratorio

Acero inoxidable. Para uso diestro y zurdo. El tambor tiene 1.75" / 4.4 cm de ancho.

ITEM #	DIA
746607	8.25 x 2 1/8 x 3.25" 21 x 5.4 x 8.3 cm



Aluminum Cheese Slicer

Die-cast polished aluminum with an adjustable roller.

Cortadora de queso de aluminio

Aluminio pulido fundido a presión con un rodillo ajustable.

ITEM #	DIA
386	4" / 10.1 cm
(Replacement wire only / Solo alambre de repuesto)	
386W	4" / 10.1 cm



Jumbo Rotary Cheese Grater

Stainless Steel. For right and left handed use. Drum is 2.125" / 5.4 cm wide.

Rallador de queso giratorio Jumbo

Acero inoxidable. Para uso diestro y zurdo. El tambor mide 2.25" / 5.4 cm de ancho.

ITEM #	DIA
746586	8.25 x 2.5 x 3.75" 21 x 6.4 x 9.5 cm



Cuisipro.

Y Peeler

- Carbon steel blade for an enduring sharp edge
- Ergonomic handle provides a secure grip
- Zinc alloy head for long-term durability
- Dishwasher safe

PELADOR EN FORMA DE "Y"

- Cuchilla de acero de carbono para un borde de filo duradero
- Su mango ergonómico permite un buen agarre
- Cabezal resistente, de aleación de zinc, para una larga vida útil
- Se puede lavar en el lavavajillas

Make short work of longer vegetables such as zucchini and eggplant.

Acorte su tiempo al pelar frutos alargados, como el calabacín y la berenjena.



Cuisipro Y Peeler

This 2-in-1 tool also features a digger tool for efficient removal of fruit and vegetable blemishes.

Pelador en forma de "Y" Cuisipro

Esta herramienta de doble utilidad también cuenta con una punta especial para quitar las imperfecciones.

ITEM #	DIA
747064	7.3" / 18.5 cm



Soft outer bristles are thin to hold sauce while inner bristles are hard to help spread the sauce

Filamentos exteriores suaves y delgados, para retener la salsa Filamentos interiores más rígidos, para ayudar a extenderla



Cuisipro Silicone Basting Brush

Evenly bastes poultry, roasts and pastry with ease. Heat-resistant to 425°F/220°C. Easy to clean - #dishwasher safe

Pincel rociador de silicona Cuisipro

Para untar cómodamente aves, asados y masas de repostería. Resistente hasta 425° F / 220° C. Fácil de limpiar - Lavable en el lavaplatos

ITEM #	DIA
74714801	8" / 20 cm



The innovative scraper automatically scrapes as you turn.

La espátula de diseño ingenioso lo hace automáticamente cuando usted gira la manivela.



4mm disk – ideal for applesauce |
Disco de 4 mm – ideal para hacer compota de manzanas

2mm disk – for removing seeds out of tomato purée |
Disco de 2 mm – para quitarle las semillas de la pasta de tomate



3mm disk – for rice potatoes |
Disco de 3 mm – para hacer puré de papas

Deluxe Food Mill

With a simple turn of the ergonomic, non-slip handle, this durable 18/10 stainless steel food mill purees a wide variety of fruit and vegetables while straining out skins, seeds and pulp. This increases efficiency by allowing a smoother, more continuous flow of food. Includes an extra large bowl and a selection of interchangeable disks in 2mm, 3mm and 4 mm sizes to control the consistency of the strain.

Molinillo de lujoe

Con un simple giro del mango antideslizante de diseño ergonómico, este molinillo durable, de acero inoxidable 18/10, le permite preparar purés de diversas frutas y verduras, a la vez que filtra la piel, la cáscara, las pepitas, las semillas y la pulpa. Esto aumenta la eficiencia al permitir el paso de la comida de una manera más homogénea y continua. Viene con un tazón muy grande y un juego de discos intercambiables de 2 mm, 3 mm y 4 mm de tamaño, para controlar la uniformidad del filtrado.

ITEM # DIM (L X W) FOLDED | PLEGADO
746479 17.25" / 43.8 cm



Cuisipro.

DELUXE FOOD MILL

- Ergonomic, non-slip handle for smooth, comfortable operation
- Sits high on top of working bowls or pots keeping mill out of food
- Blade separates juices from skins, seeds and pulp
- Ideal for pureeing baby food and smooth sauces
- Comes apart for easy cleaning

MOLINILLO DE LUJEO

- Mango de diseño ergonómico y antideslizante, para trabajar con mayor comodidad
- Se coloca sobre la parte superior del tazón o la olla que está usando, lo que lo mantiene fuera de la comida
- La hoja separa los jugos de la cáscara, las pepitas o semillas, y de la pulpa
- Ideal para hacer puré de la comida de los bebés y para hacer suaves las compotas
- Se puede desarmar para limpiarlo con facilidad

PARTS | PARTES

ITEM #	DES
746476	2mm disk Disco de 2 mm
746477	3mm disk Disco de 3 mm
746478	4mm disk Disco de 4 mm
746479-1	Plastic scraper Espátula plástica
746479-2	Crank Mechanism Mecanismo de manivela





Cuisipro.

CUT RESISTANT GLOVE*

- Category 5 cut resistance
- Made of durable, breathable flexible HPPE, glass fibre & nylon
- Machine washable, drip dry
- One size fits most. Fits left or right hand
- Use with knives, graters and mandolines

GUANTE RESISTENTE A LOS CORTES*

- Resistencia contra cortes de categoría 5
- Su tela flexible y suave es transpirable
- Lavable a máquina, secado por goteo
- Se ajusta a la mano izquierda o derecha. Para ambidextrous
- Úselo con cuchillos, ralladores y mandolinas



Cuisipro Cut Resistant Glove Guante Resistente a los Cortes

ITEM #	DIM
747329	14.2 x 4" / 36 x 10.1 cm



HANDHELDE MANDOLINE

Makes perfectly sliced food in a blink of an eye, all-in-one compact body

- Includes three interchangeable blades for slicing, crinkle & waffle cutting, grating and julienning
- Food glides effortlessly on the grooved stainless steel slicing platform
- Soft coated handles are easy to grip and non-slip

MANDOLINA MANUAL

Corta alimentos en rodajas perfectas en un abrir y cerrar de ojos, cuerpo compacto todo en uno

- Incluye tres cuchillas intercambiables para rebanar, cortar en tiras y gofres, rallar y cortar en juliana
- Los alimentos se deslizan sin esfuerzo en la plataforma de corte de acero inoxidable acanalada
- Las asas con revestimiento blando son fáciles de agarrar y antideslizantes

Cuisipro Handheld Mandoline

Adjustable thickness setting: 6 thickness options. Hand guard & instruction included.

Mandolina manual Cuisipro

Espesor ajustable: 6 opciones de espesor. Guarda de mano e instrucciones incluidas.

ITEM #	DIM (L X W) FOLDED PLEGADO
747199	14.2 x 4" / 36 x 10.1 cm

*This glove is cut resistant, not cut or puncture proof. No claim made for point puncture resistance. Este guante es resistente a los cortes, no es a prueba de cortes ni pinchazos. No se ha hecho ninguna aseveración sobre su resistencia a la punción.



de Buyer
DEPUIS 1830



ROBUST FRUIT AND VEGETABLE SLICER

- For smooth or wavy round slices, julienne cuts of 4 or 10 mm, waffle cut. Double horizontal blade, scalloped and fluted/ serrated
- Made of stainless steel and polymer composite
- Stainless steel ramp is smooth and with a textured surface to make food slide easily
- Adjustable cut thickness up to 0.5" / 10 mm
- Safety First! Slider and ergonomic pusher. Non-skid feet. Grip area on blades



Patented Integrated Cube System

Sistema de Cubo Integrado Patentado

deBuyer Swing Plus Mandoline Mandolina giratoria deBuyer

ITEM #	DIM (L X W X H)
77201503	15.8 x 5.3 x 2.1" 40 x 13.3 x 5.4 cm



Double Horizontal Blade |
Doble hoja horizontal

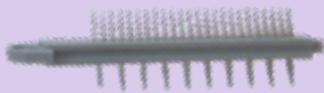

Double Julienne Blade |
Cuchilla doble juliana

ROBUSTA CORTADORA DE FRUTAS Y VERDURAS

- Hoja horizontal de doble cara: recta y dentada. Cuchillas de corte juliana de doble cara: espaciado de 4 y 10 mm
- Fabricada en acero inoxidable y polímero compuesto
- La rampa de acero inoxidable es lisa y con una superficie texturizada para hacer que los alimentos se deslicen fácilmente
- Grosor de corte ajustable hasta 2.5" / 10 mm
- ¡La seguridad es primero! Deslizador y empujador ergonómico. Patas antideslizantes. Agarre la zona en las cuchillas



Chef Mandoline Slicer

18/10 Stainless steel. Includes hand guard. 4 Julienne blades (2, 4, 7 & 10 mm). Also includes 1 serrated blade with thickness adjustment (approx 0.75") and 1 adjustable, removable straight cut blade. Revolving stand.

Mandolina rebanadora "Chef"

Acero inoxidable 18/10. Con protector de mano, 4 cuchillas para juliana (2, 4, 7 y 10 mm) y pie giratorio. También incluye una cuchilla dentada con reajustador de espesor (aproximadamente 1.9 cm - 0.75 pulg.) y una cuchilla móvil que se puede reajustar, para cortes derechos.

ITEM #	DIM (L X W X H) (FOLDED PLEGADO)
5715000	16.5 x 5.5 x 3" 42 x 14 x 7.8 cm



Mandoline Slicer. 18/10 Stainless Steel

18/10 Stainless steel. One serrated blade with thickness adjustment (approx 0.125"). One double sided julienne blade. 30 teeth / 3 mm spacing on one side, 10 teeth / 10 mm spacing on second side.

Mandolina rebanadora.

Acero inoxidable 18/10. Una cuchilla dentada con reajustador de espesor (aproximadamente 3 mm - 0.125 pulg.). Una cuchilla para Juliana de doble lado.

ITEM #	DIM (L X W X H) (FOLDED PLEGADO)
5720638	16.5 x 5.5 x 3" 42 x 14 x 7.8 cm
5719638	38 teeth Julienne blade cuchillas para juliana
5720600	Protective carriage Carro protector



ALUMINUM BUN PAN RACKS

WITH RAIL TYPE LEDGES TO SUPPORT PANS

- Suitable for freezer up to -20C.
- Wheels are Thermoplastic Rubber for up to -4°F / -20°C
- Complete with four (two locking) casters for easy transportation
- Made with aluminum for lasting durability

REJILLAS DE ALUMINIO PARA BANDEJAS DE BOLLOS

TIENE SALIENTES TIPO RIELES PARA SOSTENER LAS BANDEJAS.

- Las rejillas son apropiadas para el congelador a -20°C
- Las ruedas son de goma termoplástica adecuada para hasta -20°C
- Completa con cuatro (4) rueditas para facilitar el transporte
- Hecha en aluminio para mayor durabilidad tiene salientes tipo rieles para sostener las bandejas

All shelves are fully welded to the frame

Toutes les étagères sont entièrement soudées au cadre

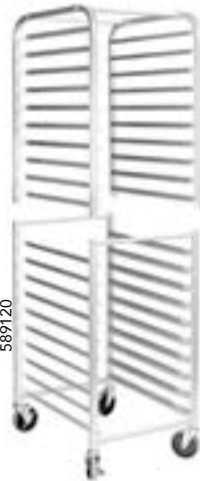
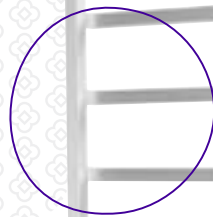

Compact design. Easy shipping.

Diseño compacto. Envío fácil.

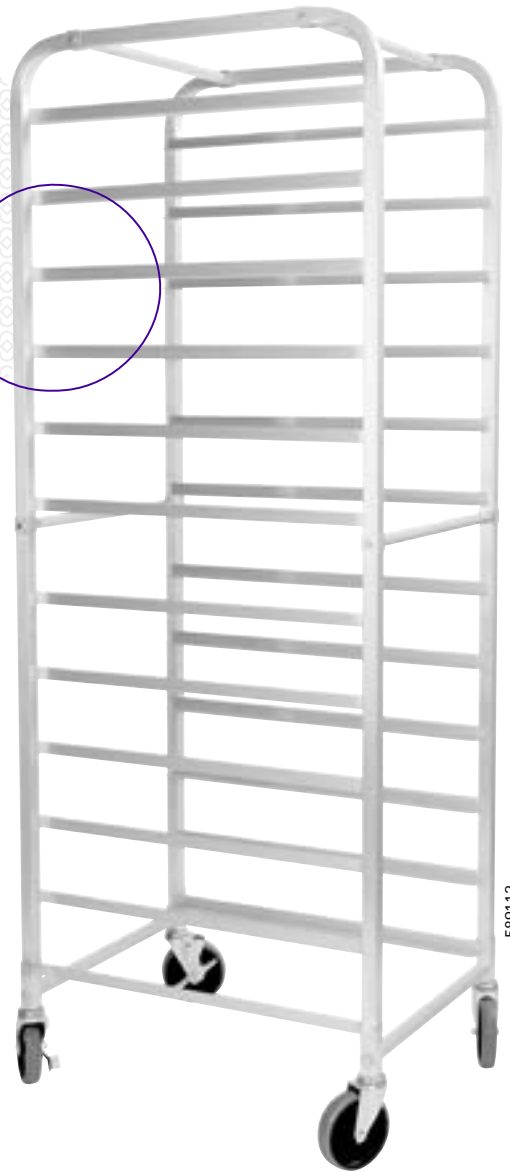

Aluminum Bun Pan Rack

Holds 10, 12, or 20 full-size sheet pans. Ships flat, assembly required.

Rejillas de aluminio para bandejas de bollos

Sostiene 10, 12 o 20 bandejas para hornear de tamaño completo, respectivamente

ITEM #	DIM (W X D X H)	NOTES	ITEM #	DES
10 Tiers niveles 589110	26 x 20.25 x 44" 66 x 51 x 113.24 cm		589110-1	Swivel casters Rueda giratoria
12 Tiers niveles 589112	25.6 x 20.5 x 69" 65 x 52 x 175.24 cm	Compact design Diseño compacto		
20 Tiers niveles 589120	25.6 x 20.5 x 69" 65 x 52 x 175.24 cm	Compact design Diseño compacto		
DES		DIM		DE ESPESOR
FRAME BASTIDOR:		1 x 1" square tube 1 x 1" tubo cuadrado		1.55 mm thickness 1.55 mm de espesor
SUPPORTER 6 PIECES SOPORTE: 6 PZAS		1 x 1" square tube 1 x 1" tubo cuadrado		10.6 mm thickness 10.6 mm de espesor
VERTICAL SPACING BETWEEN RAILS ESPACIO VERTICAL ENTRE LOS CARRILES		10 and 20 Tiers 10 y 20 Niveles : 3" / 7.62 cm 12 Tiers 12 Niveles : 4.85" / 12.3 cm		

589110

589120

589112



"Label-Pocket"
window / Ventana
"Label-Pocket"

Clear
Window
/ Ventana
transparente

Mold, Mildew & FHOJA
Resistant. Complies with
NFPA-701

*Resistente al moho y a
las flamas. Cumple con
NFPA-701*

Heavy Duty Rack Cover

PVC "bath method" coating over a polyester reinforcing scrim

- Cover weight is 12 oz. (340 g) per square yard
- Translucent white color
- Clear label pocket 6.5 x 5" / 16.5 x 12.7 cm and large view window
- Hang strap on top seam
- Resists cracking to - 40°F/ -40°C
- End Load

Cubre portabandejas muy resistente

Cañamazo reforzado de poliéster con cobertura (tipo "baño") de PVC

- Peso del cubre portabandejas: 340 g (12 onzas) por yarda cuadrada
- Color blanco translúcido
- Bolsillo transparente para etiqueta de 16.5 cm x 12.7 cm (6.5 x 5 pulg.) y ventana grande
- Tira para colgar en la costura superior
- Resistente al moho. Cierre delantero
- Resiste rajaduras hasta los - 40°F / -40°

ITEM #	DIM (W X D X H)
57913401	23 x 28 x 62" 58.5 x 71 x 157.5 cm

Clear Rack Cover

PVC construction for main body of cover

- Top panel made of 10 oz (283 g) per square yard white reinforced fabric with PVC laminate
- Clear menu card pocket 6.5 x 5" / 16.5 x 12.7 cm
- All covers have #5 zippers, 2 vertical seams and a 1" / 2.5 cm binding around seams & hems
- Hang strap on top seam
- Resists cracking to - 10°F / 23°C
- End Load

Cubre portabandejas transparente

Cuerpo principal de PVC

- Panel superior de tela blanca reforzada con laminado de PVC, de 283 g (10 onzas) por yarda cuadrada
- Bolsillo transparente para menú de 16.5 cm x 12.7 cm (6.5 x 5 pulg.)
- Tira para colgar en la costura superior
- Resistente al moho
- Resiste rajaduras hasta los - 10°F / 23°C
- Cierre delantero

ITEM #	DIM (W X D X H)
57913400	23 x 28 x 62" 58.5 x 71 x 157.5 cm



Rack Covers

Eliminates costly cleanup. Provides excellent moisture and vapor barrier, prolonging shelf life.

Cubre Portabandejas

Elimina la costosa limpieza y proporciona, a la vez, una excelente barrera que protege de la humedad y el vapor, prolongando la vida útil de los alimentos.



Clean Up

From Dish'n'totes to grill brushes the Browne clean up collection offers everyday items to help ensure cleanliness and hygiene in small and large professional kitchens.

Limpieza

Desde cajas para recoger utensilios hasta cepillos para parrilla, la colección de limpieza Browne ofrece artículos de uso diario para ayudar a garantizar la limpieza y la higiene en cocinas profesionales grandes y pequeñas.



Cutlery Box

High density plastic (PP).
4 compartments. Seamless for easy cleaning. Odorless and noiseless.
Can be used for storage of individually packaged condiments. Narrow for tight-space storage. Dishwasher safe. Sterilizes to commercial standards.
Weight: 2.3 lbs. / 1 kg.

Organizador para cubiertos

Plástico de alta densidad (PP), 4 compartimentos. Sin costuras para su fácil limpieza. Inodoro y silencioso. Se puede usar para condimentos empaquetados individualmente. Angosto para guardarse en espacios reducidos. Se puede lavar en el lavavajillas. Se esteriliza según las normas industriales.
Peso: 540 g / 1.3 libras.

ITEM #	COLOR	DIM
1990	Grey	21.5 x 11.8 x 3.8" 54.6 x 29.8 x 9 cm



Flatware Cylinder Cilindro para cubiertos

ITEM #	DES	DIA	FACE
80110	Perforated, Stainless Steel Perforado, Acero inoxidable.	3.8" / 9.8 cm	5.5" / 14.0 cm
80113S	Solid, Stainless Steel Solida, Acero inoxidable.	3.8" / 9.8 cm	5.5" / 14.0 cm
5735	Polypropylene, Perforated. White Polietileno. Perforado Blanco.	4.3" / 10.8 cm	5.3" / 13.3 cm



Grill Screen Holder

Protects hands and evens pressure on the grill when cleaning. Clamp ensures screen held securely and permits easy changing.

Sujetador de malla limpia parrilla

Protege las manos y proporciona presión uniforme sobre la parrilla cuando se la limpia. Sujeta firmemente la malla y permite su fácil cambio.

ITEM #	DIM
3300	5 x 3" 12.7 x 7.6 cm

Broiler / Grill Brush

Cleans grills, grates and rotisseries with very stiff brass wire bristles. Ergonomic plastic handle.

Cepillo para parrilla / rejilla de horno

Limpia la parrilla, rejillas y asadores giratorios con cerdas muy duras de alambre de latón. Mango ergonómico de plástico.

ITEM #	DIM
4203	11" / 28 cm

Wire Brush with Scraper
Hardwood. 3 x 19 rows of wire bristles.

Cepillo de limpieza de alambre con raspador
De madera dura.
Filas de cerdas de alambre (3 x 19).

ITEM #	DIM
574260	14" / 35.5 cm

Long Handle Wire Brush with Scraper
Hardwood. 4 rows of wire bristles
Outer: 2 x 10 rows Inner: 2 x 12.

Cepillo de limpieza de alambre con raspador
Filas de cerdas de alambre (2 x 10; 2 x 12). De madera dura.

ITEM #	DIM
574267	20" / 51 cm



Overflow Tube

Brass nickel-plated tube with neoprene stopper. For use in 1.5" / 3.8 cm sink drains.

Tubos rebosaderos

Tubo de latón niquelado con cuello hermético de neopreno. Para su uso en fregaderos con desagües de 3.8 cm (1 1/2 pulg.)

ITEM #	LENGTH
40100200	7.5" / 9 cm
40100255	10" / 25 cm
40100305	12" / 30 cm



Glass Brush
Cepillos para vasos

ITEM #	DES	DIM
616112	Double Doble	8.5" / 21.6 cm
616113	Triple Triple	8.5" / 21.6 cm



Medium Size Stainless Steel Sponge
Esponja de acero inoxidable

ITEM #	DIA
571950	3.5 x 2.3" / 8.9 x 5.7 cm



Pizza Oven Brush

Brass wire bristles. Steel blade scraper affixed to solid wood block.

Cepillo para limpieza de horno para pizza

Cerdas de alambre de latón. Raspador con cuchilla de acero adherido a bloque sólido de madera.

ITEM #	DIM	BLOCK BLOQUE
611001	36" / 91.4 cm	10 x 1.5" / 25.4 x 3.8 cm

Alphabetical English

#

18/0 Flatware 69-75
 18/10 Flatware 65-67
 2-Ply Cookware 24

A

Adapter Bars..... 115
 Aluminum Bun Pan ... 154
 Aluminum Cookware 26
 Au Gartin 89, 92

B

Bain Marias 116
 Baker 89
 Baker
 Combi Oven 38, 39
 Baking Mat 153
 Bar Caddy 104
 Bar Mat 109
 Bar Service 102
 Bar Spoon 105
 Bar Strainer 105
 Bar Tong 106
 Beverage Dispenser 54
 Bistro Flatware 70
 Black Handle Tools 121-122
 Boning Knife 122, 127
 Bottle Opener 107
 Bowl 80
 Brazier
 Aluminum HW 27
 Aluminum SW 30
 Stainless Steel ... 22, 43
 Bread Basket..... 92
 Bread Knife 122
 Brioche Molds 168
 Buffet / Catering 44
 Bun Pan Rack 181
 Bun Pan Rack Cover 182
 Butter Spreader 119
 Butter Warmer 92

C

Cadence Chafer 52
 Cake Cover 165
 Call Bell 100
 Can Opener 147
 Carbon Steel Cookware
 34
 Cast Iron Cookware... 33
 Cast Iron Serving ... 86, 87
 Celine Flatware 73
 Cereal Dispenser 54
 Chafer Accessories ... 53,
 54
 Chargers 160
 Check Holder 116

Cheese Grater 176
 Cheese Shaker 95
 Cheese Slicer 176
 Clean Up 183
 Cleaver 122
 Cocktail Shaker 103
 Coffee Decanter 98
 Coffee Urn..... 46, 50
 Collanders 144
 Colour-Coded Boards 126
 Colour-Coded Knives 127
 Colour-Coded Ladle 130
 Colour-Coded Portioners
 130
 Colour-Coded Tongs 128
 Combi Oven Accessories
 35
 Concerto Flatware ... 67
 Contour Flatware..... 72
 Cook Knife 122, 127
 Corer 146
 Corkscrew 107
 Creamer..... 99
 Crisping Tray..... 40
 Culinary Basket..... 143
 Cup 82
 Cut Glove 179
 Cutlery Box 184
 Cutting Board Holder 126
 Cutting Boards 126

D

Deep Sauce Pan 21
 Deep Stock Pot 23
 Delivery Bag 62
 Dish Tote 184
 Dishers 129, 134
 Dominion Flatware ... 75
 Double Boiler
 Aluminum SW 31
 Stainless Steel 23
 Dough Cutter 119,
 156, 161
 Dough Scraper 156
 Dredge 166
 Dry Measures 166

E

Eclipse Flatware 65
 Eclipse Serving Tools
 55-58
 Economy Chafer 53
 Egg Slicer 143
 Elegance Flatware ... 73
 Elements Cookware 41
 Elite Serving Tools ... 60
 Escargot Plate 89

F

False Bottoms 115
 Fibre Glass Tools 133
 Flatware..... 64-75

Flatware Cylinders ... 184
 Flour Sifter 167
 Food Mill 178
 Footed Grate 115
 Foundation Porcelain 79
 Fry Basket 143
 Fry Cup 90
 Fry Cutter 147
 Fry Pan
 2-Ply 25
 Tri Ply 17
 Carbon Steel 34
 Aluminum HW 27
 Aluminum SW 29
 Stainless Steel ... 20, 42
 Funnel 161

G

Garlic Press 145
 Glass Brush 185
 Glass Rimmer 105
 Goblet 168
 Gobel 155
 Grater..... 176
 Gravy Boat 91
 Grid..... 40
 Grill Brush 185
 Grill Scraper ... 118, 121,
 124
 Grill Screen Holder ... 184

H

Harmony Collection... 47
 High Chair 101
 Hot Pad 150

I

Ice Bucket 100
 Ice Chipper 106
 Ice Cream Scoop 134
 Ice Scoop 106
 Innova Tools 117-119

J

Jiggers 108
 Juice Dispenser ... 46, 50

K

Kitchen Grips Pro..... 148
 Kitchen Service..... 110
 Knife Rack 127

L

Ladle 130, 131
 Ladle 57, 60, 61
 Lafayette Flatware ... 71
 Lemon/Lime Squeezer
 105
 Liquid Measures 166
 Loaf Pan..... 164, 168
 Lobster Utensils 78
 Lumino Flatware 69
 Luna Flatware 65

M

Madeleine Sheet 169
 Malt Cup 105
 Mandoline 180
 Masher 145
 Measuring Cups 167
 Measuring Spoon..... 167
 Melon Baller 146
 Menu Holder..... 100
 Milk Frother 99
 Mixing Bowls 144
 Modena Flatware..... 66
 Modena Serving Tools 61
 Muddler 105
 Muffin Pan 164
 Mug 82

N

Napkin Dispenser ... 100
 New Era Seving Tools 61
 Nylon Spoon 152

O

Octave Collection ... 45
 Oil and Vinegar 95
 Onion Soup Bowl..... 88
 Oven Glove 149
 Oven Mit 148-150
 Overflow Tube 185
 Oxford Flatware 71
 Oyster Knife 146

P

Pan Grip..... 175
 Pan Sleeve 150
 Paring Knife 122
 Paris Flatware 72
 Pasta Cooker
 Aluminum SW 32
 Stainless Steel 23
 Pasta Insert 22
 Pasta Machine 147
 Pastry Bag 153
 Pastry Brushes 162,
 163, 177
 Pastry Cutter..... 161
 Peeler 146, 177
 Pie Cutter 164
 Pie Plate..... 164
 Pie Server 56, 60, 61,
 119, 121, 124
 Pizza Cutter 120, 175
 Pizza Oven Brush 185
 Pizza Pan 172-173
 Pizza Peels..... 174
 Plate 81
 Platter 81
 Portioners 130
 Pot Fork 124
 Pot Holder..... 150
 Potato Masher 145

Poultry Shears 145
 Pourer 108 - 109
 Precision Tongs..... 139

Q

Quiche Pan 169

R

Ramekins 89
 Rectangular Chafer ... 45,
 47, 49, 51, 52
 Ricer 145
 Roast Pans
 Aluminum 32
 Combi Oven 36
 Tri Ply 18
 Roller Docker 175
 Rolling Pin 151
 Rondo Chafer 52
 Round Chafer 46, 48,
 49, 52
 Royal Flatware 74

S

Salt and Pepper Mill 93
 Salt and Pepper Shaker 96
 Sandwich Spreader ... 121,
 124
 Sauce Cup 91
 Sauce Pan
 Aluminum HW ... 27, 28
 Aluminum SW ... 30, 31
 Stainless Steel ... 20, 21,
 42
 Saucer 82
 Saute Pan
 Aluminum SW 29
 Stainless Steel ... 20, 42
 Scoops 161
 Scraper 152
 Serving Fork ... 56, 60, 61
 Serving Spoons 135 - 137
 Serving Tools..... 55-61
 Serving Utensils 136
 Sharpening Steel 122
 Sharpening Stone ... 127
 Sieve 164
 Skillet 33, 87
 Skimmers 141
 Skimmers 142
 Soup Station 46, 50
 Spaghetti Fork 139
 Spaghetti Tongs 139
 Spatula ... 119, 123, 124
 Sponge 57, 60, 61,
 152, 185
 Spring Form Pan 163
 Squeeze Bottle..... 94
 Stainless Steel Cookware
 19
 Steak Knife 76-78
 Steak Platter 92

Steak Tenderizer 146
 Steak Weights 146
 Steam Pan 111-114
 Steam Pan Covers ... 115
 Stock Pot
 Aluminum HW 28
 Aluminum SW 31
 Stainless Steel 43
 Strainers..... 140 - 142
 Sugar Pack Holder ... 92
 Sugar Pourer 93, 95
 Sundae Dish 91
 Symphony Chafer ... 51
 Syrup Dispenser 95

T

Table Top 63
 Taco Basket 143
 Tart Mold 168
 Tart Ring 164
 Teapot 97 - 98
 Tenderizer 146
 Thermometer ... 170-171
 Timer 171
 Tongs 57, 58, 128,
 137, 138, 139
 Tray 37, 38
 Tray Stand 101
 Tri Ply Cookware 16
 Turner... 56, 118, 121, 123

U

Underliner 92

V

Vegetable Inserts 116

W

Waffle Fork 59
 Water Pitcher 99
 Whip 155
 Whip Cream Dispenser ...
 157-159
 Whisk 155
 Win2 Flatware 74
 Windsor Flatware..... 75
 Wine Bucket 100
 Wire Skewers 93
 Wok 17
 Wood Boards 83-85
 Wood Handle Tools
 123-124

Z

Zester 106



ITEM	PAGE PÁGINA	ITEM	PAGE PÁGINA	ITEM	PAGE PÁGINA	ITEM	PAGE PÁGINA	ITEM	PAGE PÁGINA
Alfabético									
Español									
A									
Ablandador	146	Cepillo de vidrio	185	Dispensador de crema batida	157-159	Mandolina	180	Prensa	145
Ablandador de bistec	146	Cepillo para horno de pizza	185	Dispensador de jarabe	95	Manga pastelera	153	Prensa de patatas ...	145
Abrebotellas	107	Cepillo para parrilla ...	185	Dispensador de jugo	46, 50	Mangos de cocina profesionales	148	Prensa para ajo.....	145
Abrelatas	147	Cesta de pan.....	92	Dispensador de servilletas	100	Mano de mortero.....	105	R	
Accesorios para calentador	53, 54	Cilindros para cubiertos ...	184	Dominion	75	Manopla para el horno	148 - 150	Rack para panecillos	181
Accesorios para hornos combinados	35	Cocedor de pasta Acero inoxidable ...	23	E		Máquina para hacer pasta	147	Rallador	176
Aceite y vinagre	95	Aluminio	32	Eclipse	65	Marcador rodante ...	175	Rallador de cítricos ...	106
Afilador de acero	122	Colador de bar	105	Elegance	73	Medidas líquidas	166	Rallador de queso ...	176
Alfombrilla para bar	109	Coladores	144	Embudo	161	Medidas secas	166	Rallar	155
Alfombrilla para hornear	153	Coladores	140 - 142	Escarchadora de vidrio	105	Modena	66	Ramequines	89
Almohadilla caliente	150	Colección Harmony ...	47	Esparcidor de mantequilla	119	Molde de tarta	168	Raspador	152
Anillo de tarta	164	Colección Octave.....	45	Esparcidor de queso	95	Molde para muffins ...	164	Raspador de parrilla	118, 121, 124
Arrocera.....	145	Concerto	67	Esparcidor para sándwiches	121, 124	Molde para pan	164, 168	Raspador de pasta ...	156
Asa para sartén	175	Contour	72	Espátula ...	119, 123, 124	Molde para pan de aluminio	154	Rebanador de huevos	143
Astillador de hielo ...	106	Copa de malta	105	Espátula de cocina ...	56,	Molinillo de alimentos	178	Rodillo	151
Au Gartin	89, 92	Copa para freír	90	de	118, 121, 123	Molinillo de sal y pimienta	93	Royal	74
B									
Bandeja	37, 38	Cortador de masa ...	119,	F		O		S	
Bandeja para freír ...	40	156, 161	Fondos falsos	115	Olla Acero inoxidable ...	43	Sacacorazones	146
Baño María	116	Cortador de pasteles	161	Fuente	81	Aluminio	28, 31	Sacacorchos	107
Barras adaptadoras ...	115	Cortador de pizza.....	120, 175	Funda para sartén ...	150	Olla honda.....	23	Salero y pimentero ...	96
Base	92	Cortador de tarta.....	164	Exprimidor de limón/lima	105	Oxford	71	Salsera	91
Batidor	155	Cortador para freír ...	147	G		P		Sartén	
Batidor de coctéles ...	103	Cortaquesos	176	Gobel	168	Pala para hielo	106	Acero inoxidable 20, 42	
Batir	155	Cubeta de hielo	100	Grilla	40	Palas para pizza	174	Aluminio ... 27, 29	
Bolsa de entrega	62	Cubeta de vino.....	100	Guante anticortes ...	179	Panadero	38, 39, 89	Tri-Ply.....	25
Bolsa para platos	184	Cubierta de pastel ...	165	Guante para el horno	149	Paris	72	Sartén para pizza	172-173
Botella exprimible ...	94	Cubierta de rack para panecillos	182	H		Parrilla con patas	115	Sartén para quiche ...	169
Brasero Acero inoxidable	22, 43	Cubiertas para sartén de ahumado	115	Herramientas de mango negro	121-122	Pelador	146, 177	Sartén skillet	33, 87
Aluminio	27, 30	Cubiertos	64-75	Herramientas para servir	55-61	Pesos para bistec.....	146	Sartenes para asar Aluminio	32
Brochetas de alambre	93	Cubiertos 18/0 ...	69-75	Hervidor doble Acero inoxidable ...	23	Piedra de afilar	127	Horno combi	36
Buffet/Catering	44	Cubiertos 18/10 ...	65-67	Aluminio	31	Pinceles de pastelería	162, 163, 177	Tres capas	18
C									
Cacerola para salsa Acero inoxidable	21	Cuchara de bar.....	105	I		T		Servicio de bar	
Cacerola para salsa	28, 31	Cuchara de nylon	152	Inserto para pasta ...	22	Pinzas codificadas por colores	128	Servicio de cocina ...	110
Caja de cubiertos.....	184	Cuchara de nylon	152	Insertos para verduras	116	Pinzas de bar	106	Servidor de tarta ...	56, 60,
Calentador Cadence	52	Cuchara medidora ...	167	J		Pinzas de precisión ...	139	61, 119, 121, 124
Calentador de mantequilla	92	Cuchara para helado	134	Jarra de agua	99	Pinzas para espagueti	139	Silla alta	101
Calentador Economy	53	Cucharas	161	Jarrita para leche.....	99	Platillo	82	Soporte de bandeja... ..	101
Calentador rectangular ...	45, 47, 49, 51, 52	Cucharas para servir	135 - 137	Jiggers	108	Plato	81	Soporte de protector de parrilla	184
Calentador redondo	46,	Cucharón	57, 60, 61,	L		Plato de bistec	92	Soporte para tabla de cortar	126
.....	48, 49, 52	130, 131	Lafayette	71	Plato de sundae	91	T	
Calentador Rondo ...	52	Cucharón codificado por colores	130	Lámina de magdalenas	169	Plato llano	63	Tablas codificadas por colores	126
Calentador Symphony	51	Cuchillo de carne ...	76-78	Lavaplatos.....	129, 134	Plato para caracoles	89	Tablas de cortar	126
Canasta Culinary	143	Cuchillo de carnicero	122	Limpieza.....	183	Plato para tarta	164	Tablas de madera... ..	83-85
Canasta para freír ...	143	Cuchillo de cocina.....	122, 127	Lumino	69	Porcelana Foundation	79	Tamiz	164
Canasta para tacos ...	143	Cuchillo para deshuesar ...	122, 127	Luna	65	Porcionadoras	130	Tamiz de harina	167
Cargadores	160	Cuchillo para ostras... ..	146	M		Porcionadores codificados por colores	130	Taza.....	82
Carrito para bar	104	Cuchillo para pan.....	122	Mandolina	180	Portacuchillos	127	Taza de salsa	91
Celine	73	Cuchillo para pelar ...	122	Manga pastelera	153	Portamenú.....	100	Taza de salsa	91
		Cuchillos codificados por colores	127	Mangos de cocina profesionales	148	Portaolla	150	Tazas medidoras	167
		de bistró	70	Mano de mortero.....	105	Portapaquetes de azúcar	92	Tazón	80
		D		Manopla para el horno	148 - 150	Portatarjetas	116		
		Decantador de café... ..	98	Máquina para hacer pasta	147				
		Dispensador de bebidas	54	Marcador rodante ...	175				
		Dispensador de cereales	54	Medidas líquidas	166				

ITEM PAGE | PÁGINA

Tazón de sopa de cebolla	88
Tazones para mezclar	144
Temporizador	171
Tenazas	57, 58, 128, 137, 138, 139
Tenedor de espagueti	139
Tenedor de waffles ...	59
Tenedor para olla	124
Tenedor para servir ...	56, 60, 61
Termómetro	170-171
Tetera	97 - 98
Tijeras para carne de aves	145
Timbre de llamada ...	100
Tubo de desbordamiento	185

U

Urna de café	46, 50
Utensilio para hacer bolas de melón	146
Utensilios de cocina de acero al carbono	34
Utensilios de cocina de acero inoxidable	19
Utensilios de cocina de aluminio	26
Utensilios de cocina de dos capas	24
Utensilios de cocina de hierro fundido	33
Utensilios de cocina Elements	41
Utensilios de fibra de vidrio	133
Utensilios de mango de madera	123-124
Utensilios Innova	117-119
Utensilios para langosta	78
Utensilios para servir	136
Utensilios para servir de hierro fundido	86, 87
Utensilios para servir Eclipse	55-58
Utensilios para servir Elite	60
Utensilios para servir Modena	61
Utensilios para servir New Era	61
Vaporizador de leche	99
Vaso	82
Vertedor	108 - 109
Vertedor de azúcar	93, 95

W

Win2	74
Windsor	75
Wok	17



ITEM#	PAGE PÁGINA	ITEM#	PAGE PÁGINA	ITEM#	PAGE PÁGINA	ITEM#	PAGE PÁGINA	ITEM#	PAGE PÁGINA
Numerical Numérico		22112	112	30173	82	5		502303	70
1		22114	112	30178	82	501402	69	502304	70
1100	94	22116	112	30181	82	501403	69	502305	70
1101	94	22122	111	30186	81	501405	69	502310	70
1102	94	22124	111	30187	81	501410	69	502311S	70
1147K	107	22126	111	30188	81	501411S	69	502313	70
1199	107	22132	112	30189	81	501413	69	502314	70
1219	145	22134	112	30190	81	501414	69	502317	70
1226SP	146	22136	112	30191	81	501417	69	502321	70
123	106	22142	112	30192	81	501421	69	502323	70
1260	167	22144	112	30193	81	501423	69	502325	70
1290	108	22146	112	30194	81	501425	69	502402	67
1291	108	22162	112	30195	81	501902	72	502403	67
1292	108	22164	112	30196	81	501903	72	502404	67
1293	108	22166	112	30197	81	501904	72	502405	67
1294	108	22192	112	30198	81	501904	72	502410	67
1295	108	22194	112	3199	176	501905	72	502411S	67
1306	141	22232	111	3300	184	501910	72	502412	67
1307	141	22234	111	368	161	501911S	72	502413	67
1307T	141	22236	111	369	161	501913	72	502417	67
1308	141	22240	111	370	161	501914	72	502421	67
1309	141	22241L	111	375	141	501917	72	502423	67
1309T	141	22242	111	37512	147	501921	72	502502	73
1618	145	22244	111	37514	147	501923	72	502503	73
1623	145	22246	111	37538	147	501925	72	502504	73
1725	145	2226	161	386	176	501926	72	502505	73
1726	145	2316EH	167	386W	176	502002	71	502506	73
18096	140	23501	174	4		502003	71	502510	73
18098	140	23506	174	40100200	185	502005	71	502511S	73
18099	140	23516	174	40100255	185	502010	71	502512	73
18196	140	26099	126	40100305	185	502011S	71	502513	73
18198	140	2750	136	4125	100	502013	71	502514	73
18199	140	2752	136	4145	100	502016	71	502515	73
1900	184	2754	136	4155	100	502021	71	502516	73
19095	140	2760	136	4165	100	502022	71	502517	73
19096	140	2762	136	4203	185	502023	71	502521	73
19097	140	2764	136	44221	98	502025	71	502522	73
19098	140	2770	136	44222	98	502102	65	502523	73
19099	140	2772	136	44223	98	502103	65	502525	73
1919	184	2774	136	44228	98	502104	65	502602	74
19195	140	3		4511	138	502105	65	502603	74
19196	140	30101	82	4512	138	502110	65	502604	74
19197	140	30102	82	4513	138	502111S	65	502610	74
19198	140	30103	82	4750	135	502112	65	502611S	74
19199	140	30106	81	4752	135	502113	65	502613	74
1990	184	30108	81	4754	135	502114	65	502614	74
19930	156	30110	81	4760	135	502115	65	502615	74
19936	156	30111	81	4762	135	502117	65	502617	74
19942	156	30115	81	4764	135	502121	65	502622	74
19948	156	30117	81	4764	135	502122	65	502623	74
19960	156	30118	81	4765	135	502123	65	502625	74
		30120	82	4766	135	502125	65	502702	73
		30150	80	4767	135	502202	71	502703	73
		30152	80	4770	135	502203	71	502710	73
		30153	80	4772	135	502205	71	502711S	73
		30154	80	4774	135	502210	71	502713	73
		30155	80	4775	135	502211S	71	502714	73
		30157	80	4776	135	502213	71	502715	73
		30158	80	4777	135	502214	71	502723	73
		30162	81	4780	136	502215	71	502802	75
		30163	81	4781	136	502217	71	502803	75
		30166	81	4782	136	502221	71	502804	75
		30168	81	4783P	136	502222	71	502810	75
		30169	81	4784P	136	502223	71	502811	75
		30170	81			502302	70		

ITEM#	PAGE PÁGINA	ITEM#	PAGE PÁGINA	ITEM#	PAGE PÁGINA	ITEM#	PAGE PÁGINA	ITEM#	PAGE PÁGINA
5028115	75	515039	91	5513YL	128	571610	84	5724040	21
502811S	75	515040	91	5551	124	571643	85	5724041	20
502813	75	515043	91	563930	99	571680	85	5724042	20
502814	75	515044	91	563933	98	571712	84	5724048	20
502815	75	515045	91	564001	92	571808	84	5724050	20
502817	75	515047	91	564002W	88	571912	96	5724051	20
502823	75	515048	91	564003W	89	571922	142	5724052	20
502825	75	515057	91	564004BR	89	571923	142	5724054	14
502902	72	515058	91	564004W	89	571924	142	5724058	20
502903	72	515059	91	564005W	89	571925	141	5724060	20
502910	72	515061	91	564006	88	571926	141	5724061	20
502911S	72	515062	90	564008	89	571928	141	5724062	20
502912	72	515064	90	564010W	89	571929	171	5724064	20
502913	72	515065	90	564011	89	571930	96	5724068	23
502914	72	515070	99	564012W	89	571934	96	5724072	23
502915	72	515071	99	564013	89	571950	185	5724076	23
502917	72	515072	99	564014	89	5719638	180	5724080	23
502923	72	515073	99	564015W	89	5720375	147	5724082	23
502925	72	515080	99	564021W	89	5720600	180	5724090	23
503002	66	515151	97	564022W	89	5720638	180	5724092	17
503003	66	515152	97	564023W	98	57208	84	5724093	17
503004	66	515153	97	564024W	89	572111	136	5724094	17
503005	66	515154	97	571110	155	572112	136	5724095	17
503010	66	515200	97	571112	155	572113	136	5724096	17
503011S	66	515202	99	571114	155	572120	93	5724097	17
503012	66	515262	97	571116	155	572121	93	5724098	17
503013	66	5316	174	571118	155	572131	136	5724100	17
503014	66	5430502	148, 149	571120	155	572132	136	5724102	17
503015	66	5430702	148, 149	571122	155	572133	136	5724104	17
503017	66	5431202	149	571124	155	572151	136	5724116	20, 21
503021	66	5431502	149	571140	155	572152	136	5724120	20, 21
503022	66	5431802	149	5712001	153	572153	136	5724122	20, 21
503023	66	5432202	149	571210	155	57221	100	5724124	20, 21, 23
503025	66	5432502	149	571212	155	5723054	20	5724126	23
503202	65	5432802	149	571214	155	572311	137	5724128	20, 21, 23
503203	65	5434102	148	571216	155	572312	137	5724132	21, 23
503204	65	5434202	148	571218	155	572313	137	5724134	23
503205	65	5436102	150	57124	165	572331	137	5724136	21
503210	65	5436502	150	57125	165	572332	137	5724140	22
503211S	65	5437102	150	5712510	153	572333	137	5724145	22, 23
503213	65	5439002	150	5712511	153	572351	137	5724150	22, 23
503214	65	5442002	150	5712512	153	572352	137	5724151	18
503217	65	5442102	150	5712514	153	572353	137	5724161	21
503221	65	5443502	149	5712515	153	5723908	23	5724162	21
503223	65	5443602	149	5712517	153	5723910	23	5724164	21
503225	65	5500W	75	5712518	153	5723912	23	5724166	21
503802	74	5502	75	5712520	153	5723916	23	5724171	22
503803	74	5503	75	5712521	153	5723920	23	5724172	22
503810	74	5504	75	5712524	153	5723924	23	5724173	22
503811S	74	5506	75	571260	85	5723932	23	5724174	22
503813	74	5508	75	571267	85	5723940	23	5724175	18
503817	74	5509	75	57128	84	5723960	23	5724176	18
503823	74	5511BK	128	57140	165	5723980	23	5724177	18
5116	174	5511GR	128	57140-1	165	5724000	23	5724179	18
5117	174	5511RD	128	571412	134	5724009	22	5724180	20
515000	97	5511YL	128	571416	134	5724014	22	5724181	20
515002	97	5512BK	128	571420	134	5724019	22	5724182	20
515007	99	5512BL	128	571424	134	5724024	22	5724186	21
515009	99	5512GR	128	571465	134	5724029	22	5724188	21
515010	99	5512RD	128	5715000	180	5724032	21	5724190	21
515012	99	5512YL	128	571507	84	5724033	21	5724192	21
515022	98	5513BK	128	571515	105	5724034	21	572428	171
515023	98	5513GR	128	571525	100	5724036	21	572460	185
515030	92	5513RD	128	571600	95	5724037	21	5730026	173

ITEM#	PAGE PÁGINA	ITEM#	PAGE PÁGINA	ITEM#	PAGE PÁGINA	ITEM#	PAGE PÁGINA	ITEM#	PAGE PÁGINA
5730027	173	5733908	43	57361504	126	574064	147	574333	77
5730028	173	5733912	43	57361505	126	574064-1	147	574334	77
5730029	173	5733916	43	57361512	126	574064-2	147	574335	78
5730030	173	5733920	43	57361516	126	574074	107	574336	78
5730031	173	5733924	43	57361517	126	574075	107	574338	76
5730032	173	5733932	43	573616	85	574076	107	574339	76
5730033	173	5733940	43	57361801	126	574077BK	107	574340	76
5730034	173	5733960	43	57361803	126	574078	107	574341	76
5730035	173	5734014	43	57361804	126	574079	107	574343	77
5730036	173	5734019	43	57361805	126	574081	107	574344	77
5730037	173	5734024	43	57361812	126	574082	107	574350	159
5730038	173	5734030	43	57361816	126	574107	100	574350-1	159
573141	60	5734032	42	57361817	126	574114	141	574350-10	159
573142	60	5734033	42	573619	126	574115	141	574350-2	159
573150	60	5734034	42	573620	85	574116	141	574350-6	159
573151	60	5734035	42	573714	136	574117	141	574350-8	159
573152	60	5734037	42	573716	136	574118	141	574351-10	159
573153	60	5734040	42	573720	87	574120	141	574352	75
573154	60	5734048	42	573722	87	574126	141	574354	158
573155	60	5734050	42	573723	92	574128	141	574355	158, 159
573156	60	5734051	42	573724	33	574130	141	574355-1	159
573158	60	5734052	42	573726	33	574131	141	574355-10	159
573159	60	5734054	42	573728	33	574132	141	574355-9	159
573163	61	5734058	42	573730	33	574133	141	574356	158
573164	61	5734060	42	573732	33	574142	164	574356-10	159
573170	57	5734061	42	573735	34	574144	164	574357	160
573171	56	5734062	42	573736	34	574146	164	574358	160
573172	56	5734064	42	573738	34	574180	92	574359	160
573173	57	573408	134	573740	34	574181	92	574360	119
573174	57	573410	134	573742	34	574182	92	574361	119
573175	56	5734100	134	573745	34	574183	92	574362	119
573180	57	5734116	42	573746	30, 34	574184	92	574363	118
573181	57	573412	134	573748	34	574185	92	574364	118
573182	56	5734120	42	573752	34	574186	92	574365	118
573183	56	5734124	42	573755	87	574214	106	574375	119
573184	57	5734128	42, 43	57375505	87	574250	161	574376	118
573185	57	5734130	42, 43	573756	87	574251	161	574377	119
573186	58	5734134	42, 43	573757	87	574252	161	574378	118
573187	58	5734136	43	573758	87	574253	161	574379	119
573188	58	5734140	43	573759	87	574254	161	574380	118
573190	57	5734145	43	573760	87	574255	161	574381	119
573192	57	5734150	43	573761	87	574262	175	574382	120
573194	57	573416	134	573762	87	574263	156	574383	118
573270	57	5734185	42	573770	20	574264	156	574384	119
573271	56	5734187	42	573771	20	574265	175	574386	119
573272	56	573420	134	573772	20	574266	156	574388	119
573273	57	573424	134	573773	20	574267	185	574390	119
573274	57	573430	134	573775	20	574268	156	574392	119
573280	57	573440	134	573776	20	574269	156	574397	160
573281	57	573450	134, 159	573777	20	574304	123	574398	160
573283	56	573450-5	159	573778	20	574309	145	574399	160
573284	57	573460	134	573804	124	574311	124	574407	157
573286	58	573470	134	573806	124	574312	124	574408	157
573287	58	5735	184	573810	124	574313	124	574409	157
573288	58	57360601	126	573824	124	574314	123	574410	157
573306	129	57361201	126	573826	124	574314P	124	5744261	175
573308	129	57361203	126	573828	124	574315	123	5744262	175
573310	129	57361204	126	573830	124	574316	123	5744311	121
573312	129	57361205	126	573832	124	574317	123	5744312	121
573316	129	57361212	126	573841	106	574318	124	5744313	121
573320	129	57361216	126	574031	78	574320	123	5744314	121
573324	129	57361217	126	574032	78	574329	78	5744315	121, 133
573330	129	57361501	126	57405720	108	574330	78	5744319	121
573340	129	57361503	126	574058	147	574332	78	574456	147

ITEM#	PAGE PÁGINA	ITEM#	PAGE PÁGINA	ITEM#	PAGE PÁGINA	ITEM#	PAGE PÁGINA	ITEM#	PAGE PÁGINA
574460	122	575126	53	575205	147	575364	173		114, 115
5747005	131	575126-2	53	57521	106	575365	173	575538	111, 112, 113,
574701	131	575126-5	45, 46, 47,	575213	151	575366	173		114, 115
5747015	131		48, 49, 50, 51, 52,	575215	151	575367	173	575539	111, 112, 113,
574702	131		53, 178, 181	575218	151	575368	173		114, 115
574703	131	57513	100	575221	96	57537	138	575548	112, 113, 114,
574704	131	575135	53	575222	96	575376	174		115
574705	131	575137	52	575223	96	575377	173	575549	112, 113, 114,
574706	131	575138	52	575224	96	575378	173		115
574708	131	57514	105	575225	96	575379	173	575558	112, 113, 114,
574712	131	575147	45, 46, 47, 48,	575226	95	57538	138		115
574721	131		49, 51, 53	575227	95	57538203	152	575559	112, 113, 114,
574725	146	57515	139	575228	95	57538205	152		115
574726	146	57516	139	575229	95	575384	152	575568	112, 113, 114,
57476502	59	575160	54	575231	95	57538503	152		115
574834	105	575160-1	54	575232	96	57538505	152	575569	112, 113, 114,
574834S	105	575160-3	54	575233	95	575386	152		115
574837	104	575161	54	57525	106	575388	152	575578	111, 113, 115
57483802	104	575162	51	57526	106	575389	62	575579	111, 113, 115
57484101	109	575165	46, 48, 49, 52, 54	57527	138	57539	138	575581	116
57484103	109	575166	49	57528	138	575390	62	575582	116
57484104	109	575167	49	57529	138	575391	62	575584	116
57484105	109	57517	139	57530	139	57540	57	575585	116
57484117	109	575170	45	575307	173	575400	161	575587	116
57486602	109	575170-1	45	575308	173	575401	161	575588	116
57486612	109	575170-2	45	575309	173	575402	161	575589	116
57486702	109	575170-3	45, 46, 47,	57531	139	575403	161	575591	116
57486712	109		48, 49	575310	173	575404	161	575592	116
57486812	109	575171	46	575311	173	575405	161	575593	116
574873	161	575171-1	46	575312	173	575407	142	575598	112, 113, 114,
574875	104	575171-2	46	575313	173	575408	142		115
574876	104	575172	46	575314	173	575409	142	575599	112, 113, 114,
574877	104	575172-1	46	575315	173	575410	142		115
574950	144	575173	46	575316	173	575412	142	575605	166
574951	144	575174	46	575317	173	575441	145	575610	166
574953	144	575174-1	46, 50	575318	173	575442	145	575620	166
574954	144	575174-3	46, 50	575319	173	575443	92	575640	166
574955	144	575175	45, 47	575320	173	575444	92	575645	166
574958	144	575175-1	47, 49, 51, 52	575322	174	57547	138	575650	166
574959	144	575175-2	47, 49, 51	575324	174	57548	138	575660	166
574960	144	575175-5	45, 47, 49, 51	575326	174	57549	138	57567	58
574963	144	575176	48, 49, 52	575328	164	575507	142	575670	166
574966	144	575176-1	48, 49, 52	575329	164	575508	142	575671	166
574970	144	575176-2	48, 49	57533	139	575509	142	575672	166
57501	105	575176-3	48, 49, 51,	575330	164	575510	142	575673	166
575010	85		52, 54	5753300	176	575512	142	575674	166
57502	103	575176-6	45, 46, 47, 48,	575347	173	575514	142	575675	166
57505	103		49, 51	575348	173	575515	142	57568	58
57506	103	575177	50	575349	173	575516	155	575680	166
575063	91	575177-1	50	575350	173	575517	155	575681	166
57507	105	575178	50	575351	173	575518	155	575682	166
57508	103	575179	50, 105	575352	173	575519	155	575685	143
57509	103	575179-3	46, 50, 54	575353	173	575524	155	575687	146
57510	105	575181	95	575354	173	575525	155	575688	146
575105	164	575182	96	575355	173	575527	111, 112, 113,	575690	146
575106	164	575183	96	575356	173		114, 115	575691	93
575107	164	575185	95	575357	173	575528	111, 112, 113,	575692	93
575108	164	575186	93	575358	173		114, 115, 142,	575693	93
575110	164	575187	95	575359	173		162, 171, 172, 174	575694	101
575112	164	575190	95	57536	138	575529	111, 112, 113,	575696	101
575116	164	575191	96	575360	173		114, 115	575698	166
575117	164	575193	95	575361	173	575530	114	575699	166
575118	164	575199	58	575362	173	575532	114	5757005	131
57512	105	57520	105	575363	173	575537	111, 112, 113,	575701	131

ITEM#	PAGE PÁGINA	ITEM#	PAGE PÁGINA	ITEM#	PAGE PÁGINA	ITEM#	PAGE PÁGINA	ITEM#	PAGE PÁGINA
575702	131	5761	137	5788010...	111, 112, 113,	5813505	30	5815040	28, 31
575703	131	576201	36		114, 115	5813507	30	5815060	28, 31
575704	131	576202	36	5788120...	111, 112, 113,	5813703	29	5815080	28, 31
575706	131	576203	36		114, 115	5813705	29	5815100	28, 31
575708	131	576204	40	57913400	182	5813707	29	5815120	28
575712	131	576206	37	57913401	182	5813711	29	5815140	28
575716	131	576207	38	58100632	154	5813807	29	5815160	28
5757220	130	576209	39	5811014	32	5813808	29	5815208	31
5757221	130	576210	38	5811015	32	5813810	29	5815212	31
5757230	130	576211	40	5811061	92	5813812	29	58152140	154
5757231	130	5763	137	5811062	92	5813814	29	58152142	153
575724	131	576524	116	5811063	92	5813827	29	5815216	31
5757240	130	576536	116	5811133	29, 30	5813828	29	5815220	31
5757241	130	576548	116	5811134	29, 30	5813830	29	5815314	28, 31
575726	131	578002	114	5811135	25	5813832	29	5815320	28, 31
575727	131	57800800	94	5811136	25	5813834	29	5815326	28, 31
5757280	130	57800805	94	5811561	92	5813901	30	5815334	28, 31
5757281	130	57800817	94	5811562	92	5813902	30	5815415	27, 30
5757420	130	57801200	94	5811563	92	5813903	30	5815418	27, 30
5757421	130	57801205	94	5811611	144	5813904	30	5815424	27, 30
5757430	130	57801217	94	5811612	164	5813905	30	5815502	27
5757431	130	57801600	94	5811616	144	5813907	30	5815503	27
5757440	130	57801605	94	5811624	164	5813908	30	5815507	27
5757441	130	57801617	94	5812807	25	5813911	30	5815511	27
5757450	130	57801700	94	5812808	25	5814108	28	5815703	29
5757451	130	57801705	94	5812810	25	5814112	28	5815705	29
5757460	130	57801717	94	5812812	25	5814116	28	5815707	29
5757461	130	57802400	94	5812827	25	5814120	28	5815711	29
5757480	130	57802405	94	5812828	25	5814124	28	5815901	30
5757481	130	57802417	94	5812830	25	5814132	28	5815902	30
575767	92	57802500	94	5812832	25	5814140	28	5815903	30
575769	145	57802505	94	58131032	154	5814160	28	5815904	30
57577	138	57802517	94	58131042	153	5814180	28	5815905	30
575771	116	57803200	94	5813108	31	5814200	28	5815907	30
5757711	116	57803205	94	5813112	31	5814220	28	5815908	30
575772	116	57803217	94	5813116	31	5814240	28	5815911	30
5757721	116	57803300	94	5813120	31	5814260	28	58182632	154
575773	116	57803305	94	5813124	31	5814314	28	58182640	154
5757731	116	57803317	94	5813132	31	5814320	28	58182641	154
575774	116	5781102	113	5813140	31	5814326	28	58182642	153
5757741	116	5781104	113	5813160	31	5814334	28	589110	181
575776	116	5781106	113	5813180	31	5814415	27	589112	181
5757761	116	5781110	115	5813200	31	5814418	27	589120	181
575778	116	5781111	115	5813208	31	5814424	27		
5757781	116	5781112	113	5813208-1	31	5814502	27	6	
57578	138	5781114	113	5813212	31	5814503	27	61100	163
575782	116	5781116	113	5813212-1	31	5814507	27	611001	185
5757821	116	5781202	113	5813216	31	5814511	27	61200	163
57579	138	5781204	113	5813216-1	31	5814807	27	61200-1	163
575900	144	5781206	113	5813220	31	5814808	27	6120015	163
575901	144	5781212	113	5813220-1	31	5814810	27	61200-2	163
575903	144	5781214	113	58132640	154	5814812	27	61200-3	163
575904	144	5781216	113	58132641	154	5814814	27	616112	185
575906	144	5781302	113	58132642	153	5814827	27	616113	185
575908	144	5781304	113	5813314	31	5814828	27	63U	92
575912	144	5781306	113	5813318	32	5814830	27	69501	100
575930	144	5781402	113	5813319	32	5814832	27	69502	100
575933	144	5781404	113	5813320	31	5814834	27	7	
575936	144	5781406	113	5813326	31	5815008	28, 31	705	146
57595	100	5781602	113	5813334	31	5815012	28, 31	706	146
575950	144	5781604	113	5813415	30	5815016	28, 31	707	146
575952	144	5781606	113	5813418	30	5815020	28, 31	707H	146
57596	100	5781902	113	5813424	30	5815024	28, 31	708	146
57599	137	5781904	113	5813504	30	5815032	28, 31	709	146

ITEM#	PAGE PÁGINA	ITEM#	PAGE PÁGINA	ITEM#	PAGE PÁGINA	ITEM#	PAGE PÁGINA	ITEM#	PAGE PÁGINA
71073	139	746106	167	80124840	169	9094	141	M	
7112302	133	746107	167	80126420	169	9095	141	MT84001	171
7112303	133	746108	167	80126430	169	9096	141	MTH12	127
7112308	133	746109	144	80126432	169	9098	141	MTH18	127
7112312	133	746110	144	80126440	169	9099	141	MTH24	127
7112322	133	746111	144	80126620	169	9250	141	O	
7112324	133	746124	176, 177	80126640	169	98002	114	OT84010	171
715	100	746127	176	80164710	169	98004	114	P	
71771	152	746144	58	80193530	168	98006	114	PC12002	122
71772	152	746192	145	80193550	168	98122	114	PC1216	122
71774	152	746193	145	80193560	168	98124	114	PC1218	122
71775	152	746479	178	80193570	168	98126	114	PC12625	122
71777	152	746586	176	80193710	168	98132	114	PC1286	122
71778	152	746607	176	80193720	168	98134	114	PC1286RD	127
71782	152	746685	143	80193730	168	98136	114	PC12910	122
71785	152	746740	106	80193740	168	98142	114	PC12910BL	127
71788	152	746872	78	80193750	168	98144	114	PC12910GR	127
71894	146	746874	78	80193760	168	98146	114	PC12910RD	127
72919	131	746875	78	80194030	168	98162	114	PC12910TN	127
744041	89	747002	167	80194040	168	98164	114	PC12910WH	127
744042	89	747064	177	80194050	168	98166	114	PC12910YL	127
744044	89	74708602	138	80194060	168	98192	114	PC12912	122
744045	89	74708605	138	80194070	168	98194	114	PC1298	122
744046	89	74708702	138	80223010	168	9912RED	130	PC15410	122
744047	88	74708705	138	80223020	168	994112BLK	131	PC15510	122
744049W	88	747091	105	80293480	169	994112WH	130	PC15512	122
744050	88	747141	167	80293570	168	9941BLK	131	PG1	175
744053BR	88	74714801	177	80824920	164	9942BLK	131	PG510	112, 113, 114, 115
744053W	88	747199	179	80824940	164	9942BLU	130	PHS8	150
744071	107	747304	137	80824944	164	9943BLK	131	POM13	150
744220	98	747329	179	80824960	164	9943IVR	130	POM15	150
744220-1	98	77201503	180	80880001	161	9944BLK	131	POM17	150
744221	98	7741	131	80880101	161	9944GRY	130	POM24	150
744221-1	98	7742	131	8095	141	9946BLK	131	PS19	173
744222	98	7743	131	80973	101	9946TL	130	PS20	173
744222-1	98	7744	131	80976	101	9948BLK	131	PT84101	170
744223	98	7746	131	8098	141	9948OR	130	PT84104	170
744223-1	98	7748	131	8099	141	997	142	PT84113	170
744228	98	78767	108	813501	30	A		R	
744228-1	98	79090	143	813502	30	AH-6	150	RT84016	171
744246	151	79100	143	813503	30	C		RT84019	171
744247	151	79120	143	817	61	CT84004	170	S	
744562	152	79204	143	818	61	CT84031	170	SOM15	150
744564	152	79207	143	819	61	CT84119	170	SOM17	150
744566	152	79213	143	820	61	CT84122	170		
744568	152	79216	143	8202	99	F			
746038	144	79218	143	8202G	99	FRM15	150		
746050	164	79300	104	8203	99	FRM17	150		
746051	164	79302	104	8203G	99	FT84028	171		
746052	164	79303	104	821	127	H			
746060	163	79731	143	844715	151	H15	147		
746061	163	79734	143	844718	151	H15C	147		
746063	163	79737	143	85943	136	H15F	147		
746070	163	79741	143	85946	136	H16	147		
746071	163	79744	143	85949	136	H16B	147		
746073	163	79747	143	85952	136	H16P	147		
746074	163	79751	143	85955	136	HKP321	127		
746075	163	79754	143	88232	113	HL9115W	163		
746080	163	79757	143	88234	113	HL9116W	163		
746081	163	8		88236	113	HL9117W	163		
746083	163	80110	184	9		HL9118W	163		
746084	163	80113S	184	9091	141	HL9119W	163		
746085	163	80120020	168	9092	141				
746105	167	80124810	169	9093	141				

