

# VOLLRATH®

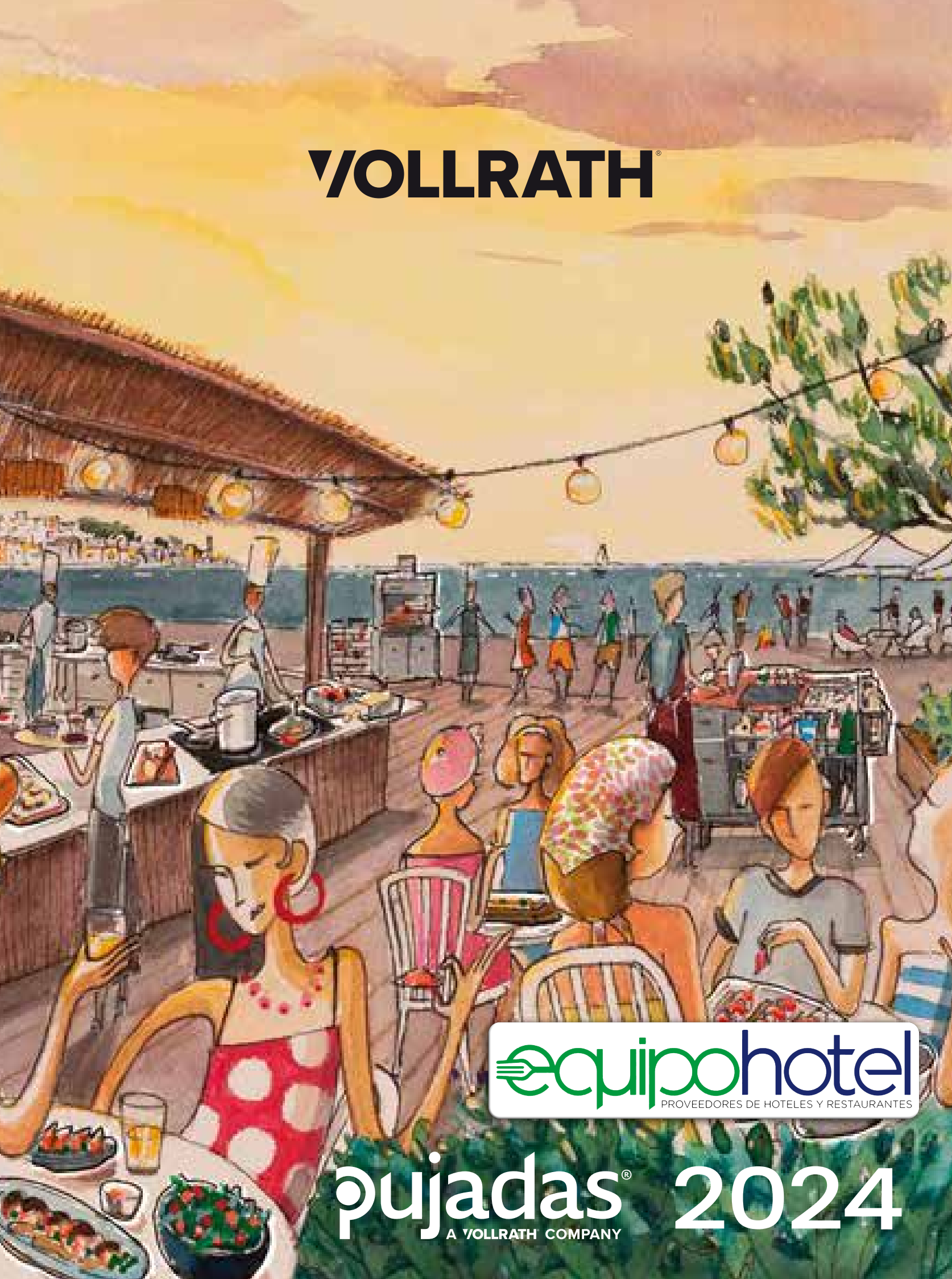

**equipohotel**  
PROVEEDORES DE HOTELES Y RESTAURANTES

**pujadas® 2024**  
A VOLLRATH COMPANY

# Pujadas Lab

## THE VOLLRATH COMPANY, L.L.C.

1236 North 18th street  
Sheboygan, WISCONSIN 53081-3201 USA  
Customer Service; 920.459.4851  
Fax. 920.459. 6537  
Credit: 920.459.5387

## VOLLRATH PUJADAS SAU

Ctra. de Castanyet, 132  
17430 Santa Coloma de Farners  
(GIRONA) - SPAIN  
Tel. +34 972 84 32 01  
info@pujadas.es

## VOLLRATH SHANGHAI TRADING LIMITED

Room 906, Building A, Hongwell Plaza, No.1308  
Lianhua Road, Minhang District  
Shanghai, 201102 CHINA  
Tel. 86-21-50589580

## VOLLRATH DE MEXICO S. DE R.L. DE C.V.

Periférico Sur edificio 2-C  
Col. Santa María Tequepexpan  
45601 Tlaquepaque, JALISCO MEXICO  
Tel. (52) 333.133.6767 or (52) 333.133.6769  
Fax. (52) 333.133.6768

# VOLLRATH

[www.vollrathfoodservice.com](http://www.vollrathfoodservice.com)

©2023 The Vollrath Company, L.L.C.  
An ISO 9001 Certified Company

**STOELTING**  
A VOLLRATH BRAND

[www.stoeltingfoodservice.com](http://www.stoeltingfoodservice.com)

**pujadas**  
A VOLLRATH COMPANY

[www.pujadas.es](http://www.pujadas.es)  
[www.pujadasgrill.com](http://www.pujadasgrill.com)

f @ in ▶

An ISO 9001 Certified Company

• Live and custom-made demonstrations and trainings

• Showroom with more than 440 m<sup>2</sup> of exhibition space

• R&D and product development

• *Demostraciones y formaciones en vivo y a medida*

• *Showroom con más de 440 m<sup>2</sup> de exposición*

• *I+D y desarrollo de producto*

• Des démonstrations et des formations en direct et sur mesure

• Showroom avec surface d'exposition de plus de 440 m<sup>2</sup>

• R&D et développement de produit

A new versatile, dynamic and welcoming space available to Foodservice professionals.

*Un espacio versátil y dinámico a disposición de los profesionales del Foodservice.*

Un nouvel espace polyvalent, dynamique et accueillant à la disposition des professionnels du Foodservice.



# VOLLRATH®

Founded in 1874, today, Vollrath remains a growing family business. Headquartered in Sheboygan, Wisconsin, with plants in the United States, Europe, Mexico, and China. The Vollrath Company is highly regarded for high-quality engineering and manufacturing. The company's business divisions encompass business operations of foodservice, frozen treat equipment, manufacturing services, and industrial cleaning equipment.

The Vollrath Company has a diverse set of resources with production, warehouse, and sales facilities around the world, as well as an international network of distributors. Vollrath drives continuous improvement in the industries it serves by being at the forefront of the group, and is recognized for leadership in its various industries with the products, services, and support it offers.

*Fundada en 1874. Vollrath sigue siendo una empresa familiar en crecimiento. Con sede en Sheboygan, Wisconsin, y con plantas en Estados Unidos, Europa, México y China. The Vollrath Company es reconocida por su ingeniería y fabricación de gran calidad. Sus divisiones de negocio abarcan operaciones comerciales en Foodservice, servicio de fabricaciones personalizadas y equipos de limpieza.*

*The Vollrath Company cuenta con varias instalaciones de producción, almacenes y ventas en todo el mundo, así como una red internacional de distribuidores. Vollrath impulsa la mejora continua de las industrias a las que sirve estando al frente del grupo y es reconocido por el liderazgo en sus diversas industrias con los productos, servicios y soporte que ofrece a sus clientes.*

Fondée en 1874. Aujourd'hui, Vollrath reste une entreprise familiale en pleine croissance. Basée à Sheboygan, dans le Wisconsin, avec des usines aux États-Unis, en Europe, au Mexique et en Chine, The Vollrath Company est très appréciée pour son ingénierie et sa fabrication de haute qualité. Les divisions commerciales de la société, englobent : Foodservice, fabrication personnalisée et équipements de nettoyage.

The Vollrath Company possède plusieurs installations de production, de stockage et de ventes dans le monde entier, ainsi qu'un réseau international de distributeurs. Vollrath favorise l'amélioration continue des industries qu'elle fournit car elle est à la tête du groupe et est reconnue pour sa place de leadership dans ses diverses industries avec les produits, les services et l'assistance qu'elle offre à ses clients.

Our legacy and continued success is based on providing value with innovative, efficient & high-quality products that stand the test of time and are trusted by chefs around the world.

- In-house design consulting
- Custom product fabrication for one-of-a-kind needs
- Easy access to customer and technical service teams that care about your products as much as you do
- Sales force that understands your local culture and clientele, and can recommend products that make sense for your unique needs
- Sustainability as a major company focus

---

*Our legacy and continued success is based on providing value with innovative, efficient & high-quality products that stand the test of time and are trusted by chefs around the world.*

- In-house design consulting
- Custom product fabrication for one-of-a-kind needs
- Easy access to customer and technical service teams that care about your products as much as you do
- Sales force that understands your local culture and clientele, and can recommend products that make sense for your unique needs
- Sustainability as a major company focus

---

Our legacy and continued success is based on providing value with innovative, efficient & high-quality products that stand the test of time and are trusted by chefs around the world.

- In-house design consulting
- Custom product fabrication for one-of-a-kind needs
- Easy access to customer and technical service teams that care about your products as much as you do
- Sales force that understands your local culture and clientele, and can recommend products that make sense for your unique needs
- Sustainability as a major company focus



# VOLLRATH INTERNATIONAL

Vollrath International was born with the mission of offering global solutions in professional catering, through an agile and efficient production and distribution structure, which achieves a worldwide presence.

*Vollrath international nace con la misión de ofrecer soluciones globales en la restauración profesional, a través de una estructura de producción y distribución ágil y eficiente que alcanza una presencia mundial.*

Vollrath international est né avec la mission d'offrir des solutions globales dans la restauration professionnelle, grâce à une structure de production et de distribution agile et efficace qui atteint une présence mondiale.

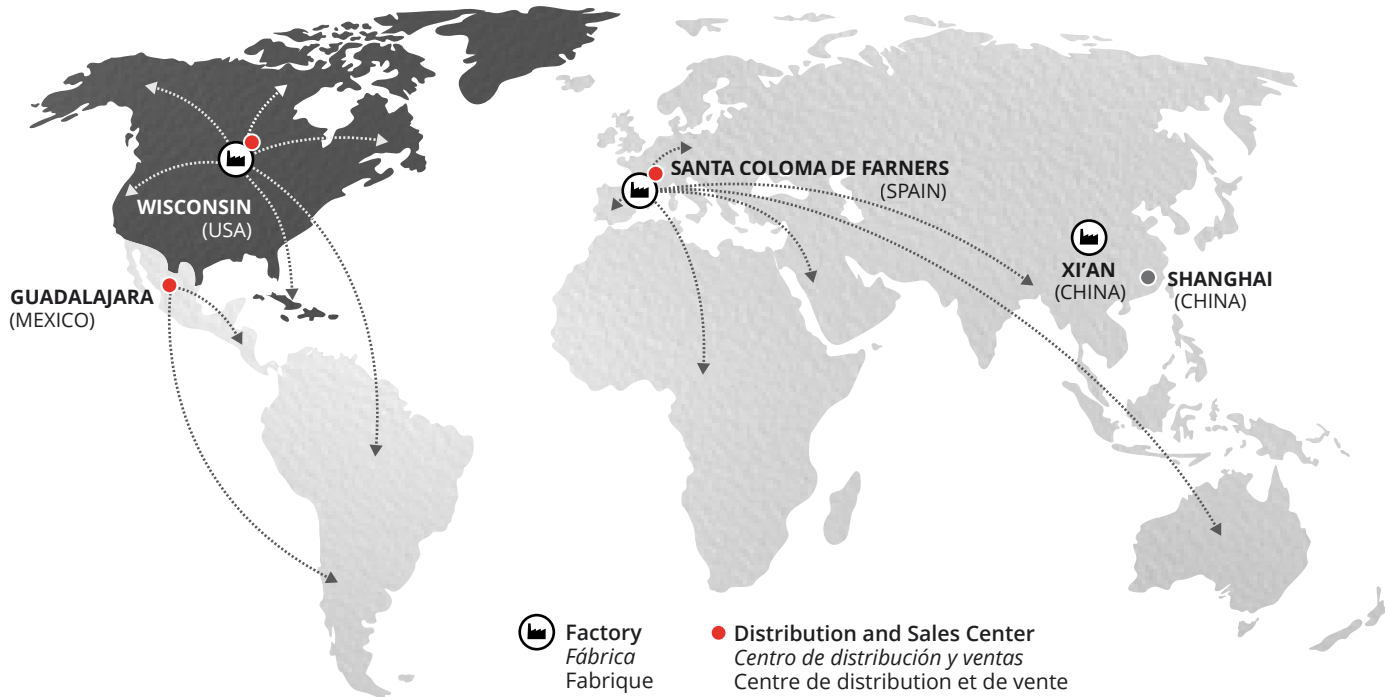

## Sales strategy

*Estrategia de ventas*  
Stratégie de soldes



## Centers of distribution

*Centros de distribución*  
Les centres de distribution



## Orders & billing

*Pedidos y facturación*  
Commandes et facturation

Selling through trusted distributors continues to be the key strategy in marketing the products and services offered by Vollrath International.

*La venta a través de distribuidores de confianza sigue siendo la estrategia clave en la comercialización de los productos y servicios que ofrece Vollrath International.*

La vente par l'intermédiaire de distributeurs de confiance continue d'être la stratégie clé dans la commercialisation des produits et services offerts par Vollrath International.

With a large stock of products located in our warehouses in Spain, the United States and Mexico, we deliver orders to our entire network of distributors with maximum logistical efficiency.

*Con un amplio stock de productos ubicados en nuestros almacenes en España, Estados Unidos y México, servimos a nuestra amplia red de distribuidores con la máxima eficiencia logística.*

Avec un large stock de produits situés dans nos entrepôts en Espagne, aux États-Unis et au Mexique, nous livrons les commandes à l'ensemble de notre réseau de distributeurs avec une efficacité logistique maximale.

Thanks to centralized order management, we offer the most efficient customer service responding in less than 24 hours.

*Gracias a una gestión de pedidos centralizada ofrecemos el más eficiente servicio al cliente dando respuesta en menos de 24 horas.*

Grâce à une gestion centralisée des commandes, on offre le service client le plus efficace répondant en moins de 24 heures.

# The global partner with your trusted brands

*El partner global con tus marcas de confianza*  
Le partenaire mondial avec vos marques de confiance



## Expansive footprint

*ADN de fabricante*  
ADN du fabricant

Production facilities and storage of  
*Instalaciones de producción y almacenamiento de*  
Installations de production et stockage de

**90.000 m<sup>2</sup>**

## Global solutions

*Soluciones globales*  
Solutions globales

Product catalog with more than  
*Catálogo de productos con más de*  
Catalogue de produits avec plus de

**7.000 SKUs**

## Efficient distribution

*Distribución eficiente*  
Distribution efficace

We distribute to more than  
*Distribuimos a más de*  
Nous distribuons à plus de

**100 countries**  
*países*  
pays

# Trusted by large partners

*Grandes marcas confían en nosotros*  
De grandes marques nous accordent leur confiance





By maintaining the same values as when we started, 100 years ago, we combine wisdom and passion, with technology and innovation to provide our clientele with the best gastronomic experience.

In our 22.000 m<sup>2</sup> facilities we manufacture kitchenware, storage systems, transport and equipment, as well as the new range of Pujadas Grill ovens.

Our wide range of innovative products, efficient systems and versatile designs means that customers all over the world trust the Pujadas brand to equip their kitchens, halls and buffets.

Since 2015 we have been part of the Vollrath Group, a world leader with which we reach more than 100 countries. This year also sees the birth of a new structure with which Pujadas, together with Vollrath USA, aims to consolidate and expand its presence worldwide.

*Manteniendo los valores de cuando empezamos, hace más de 100 años, combinamos la sabiduría y la pasión con la tecnología y la innovación para que nuestros clientes disfruten de la mejor experiencia gastronómica.*

*En nuestras instalaciones de 22.000 m<sup>2</sup> fabricamos menaje, sistemas de almacenaje, transporte y equipamiento, así como la nueva gama de hornos de brasa Pujadas Grill.*

*Nuestro amplio catálogo de productos innovadores, sistemas eficientes y diseños versátiles hace que clientes de todo el mundo confíen en la marca Pujadas para equipar sus cocinas, salas y buffets.*

*Desde 2015 formamos parte del grupo Vollrath, líder mundial con el que llegamos a más de 100 países. Este año, además, nace una nueva estructura con la que Pujadas, junto con Vollrath USA, aspira a consolidar y ampliar su presencia a nivel mundial.*

En conservant les valeurs qui étaient les nôtres lors de notre création, il y a plus de 100 ans, nous associons le savoir-faire et la passion à la technologie et à l'innovation pour aider nos clients à bénéficier de la meilleure expérience gastronomique.

Dans nos installations de 22.000 m<sup>2</sup>, nous fabriquons du matériel de cuisine, des systèmes de stockage, des moyens de transport et des équipements, ainsi que la nouvelle gamme de fours à brasse Pujadas Grill.

Grâce à notre vaste catalogue de produits innovants, de systèmes efficaces et de designs polyvalents, nos clients du monde entier font confiance à la marque Pujadas pour équiper leurs cuisines, leurs salles et leurs buffets.

Depuis 2015, nous faisons partie du groupe Vollrath, leader mondial avec lequel nous sommes présents dans plus de 100 pays. En outre, cette année, Pujadas a mis en place une nouvelle structure qui lui permettra, avec Vollrath USA, de consolider et d'accroître sa présence au niveau mondial.

# We are manufacturers

Somos fabricantes  
Nous sommes fabricants

Since 1921, we have been manufacturing highly competitive, durable and efficient products that guarantee the sustainability of every type of business.

*Desde 1921 fabricamos productos altamente competitivos, durables y eficientes que velan por la rentabilidad de cada tipo de negocio.*

Depuis 1921, nous fabriquons des produits extrêmement compétitifs, durables et efficaces qui contribuent à la rentabilité de chaque type d'entreprise.



We implement more efficient and sustainable production processes, always following strict quality protocols.

*Implementamos procesos productivos más eficientes y sostenibles, siempre siguiendo estrictos protocolos de calidad.*

Nous mettons en œuvre des processus de production plus efficaces et plus durables, en respectant toujours des protocoles de qualité stricts.



Food Contact Approved

*Apto para contacto con alimentos*

*Adapté au contact alimentaire*



Public Health and Safety

*Organización para la Salud y Seguridad Pública*

*Santé et Sécurité Publiques*



Quality System

*Sistema de Calidad*

*Système de management de la Qualité*



Quality System

*Sistema de Calidad*

*Système de management de la Qualité*



Guaranteed for life

*Garantía de por vida*

*Garantie à vie*



Bolsas hechas de materiales 100% reciclados

*Bolsas hechas de materiales 100% reciclados*

*Bolsas hechas de materiales 100% reciclados*



Thanks to the quality, dependability and performance of our equipment, along with an experienced sales & customer support staff, Stoelting has earned a strong reputation as a top manufacturer of frozen treat equipment.

We offer a full line of products that make your business more efficient, streamlining and profitable.

*Gracias a la calidad, la seguridad y el rendimiento de nuestros equipos, Stoelting se ha ganado una sólida reputación como uno de los principales fabricantes de máquinas de productos helados.*

*Ofrecemos una línea completa de productos para que el negocio sea más eficiente, ágil y rentable.*

Grâce à la qualité, à la sécurité et au rendement de ses équipements, Stoelting s'est forgé une solide réputation en tant que l'un des principaux fabricants de machines de produits glacés.

Nous proposons une gamme complète de produits pour que votre entreprise soit plus efficace, plus souple et plus rentable.

**Pujadas Grill, the complete experience for your grilled creations.**

- **Wide range of ovens, designed and manufactured in Pujadas.**
- **Accessories, cookware and complements for grilling.**
- **Range for different smoking techniques.**
- **Commissioning and after-sales support services.**
- **Extensive network of strategically distributed chef ambassadors.**
- **Preferred Distributors.**

**Pujadas Grill, la experiencia completa para tus creaciones a la brasa.**

- **Amplia gama de hornos, diseñados y fabricados en Pujadas.**
- **Accesorios, menaje y servicio de mesa para cocina a la brasa.**
- **Gama para diferentes técnicas de ahumados.**
- **Servicio de puesta en marcha y posventa.**
- **Amplia red de chefs embajadores estratégicamente distribuidos.**
- **Distribuidores preferenciales.**

**Pujadas Grill, l'expérience complète pour vos créations à la braise.**

- **Large gamme de fours, conçus et fabriqués par Pujadas.**
- **Accessoires, batterie de cuisine et arts de table spécial pour cuisiner à la braise.**
- **Gamme de produits pour différentes techniques de fumage.**
- **Un service de mise en oeuvre et de service après-vente.**
- **Un vaste réseau de chefs ambassadeurs répartis de manière stratégique.**
- **Distributeurs préférentiels.**

**N** **New**  
 Novedades  
 Nouveauté

**1 Grill**  
 Brasa  
 Braise



<b>1.1 GRILLBOX</b>	26
<b>1.2 CHARCOAL OVENS</b> <i>HORNO DE BRASA</i> <i>FOUR À BRAISE</i>	29
<b>1.3 SMOKER</b> <i>AHUMADOS</i> <i>FUMÉS</i>	32
<b>1.4 ACCESSORIES</b> <i>ACCESORIOS</i> <i>ACCESSOIRES</i>	34
<b>1.5 GRILL COOKWARE</b> <i>MENAJE BRASA</i> <i>MATÉRIEL À BRAISE</i>	36

**2 Cookware**  
 Bateria de Cocina  
 Batterie de Cuisine



<b>2.1 TRIBUTE</b>	42
<b>2.2 INOX-PRO</b>	46
<b>2.3 COOL-LINE</b>	54
<b>2.4 CENTURY</b>	56
<b>2.5 BLACK SERIES</b>	60
<b>2.6 BLACK FORGED</b>	61

**3 Fry pans**  
 Sartenes  
 Poêles



<b>3.1 WEAR EVER</b>	68
<b>3.2 TRIBUTE</b>	69
<b>3.3 ST/STEEL</b> <i>ACERO INOXIDABLE</i> <i>ACIER INOXYDABLE</i>	70
<b>3.4 ALUMINIUM</b> <i>ALUMINIO</i> <i>ALUMINIUM</i>	73
<b>3.5 MULTI-PLY</b> <i>MULTIMETAL</i> <i>MULTI-METAL</i>	77
<b>3.6 CAST ALUMINIUM</b> <i>ALUMINIO FUNDICIÓN</i> <i>FORGE D'ALUMINIUM</i>	76
<b>3.7 STEEL</b> <i>ACERO</i> <i>ACIER</i>	81
<b>3.8 SPANISH PAELLA PAN</b> <i>PAELLERA</i> <i>PLAT À PAELLA</i>	84

**4 Oven and roast pan**  
 Horno y rustideras  
 Four et plaques à rôtir



<b>4.1 ROAST PANS</b> <i>RUSTIDERAS</i> <i>PLAQUES À RÔTIR</i>	88
<b>4.2 GASTRONORM SHEET PANS</b> <i>BANDEJAS HORNO GASTRONORM</i> <i>PLAQUES FOUR GASTRONORME</i>	89
<b>4.3 PASTRY TRAYS</b> <i>BANDEJAS PASTELERÍA</i> <i>PLAQUES À PÂTISSERIE</i>	90
<b>4.4 GRIDS</b> <i>REJILLAS</i> <i>GRILLES</i>	92
<b>4.5 PIZZA BAKING SHEETS</b> <i>BANDEJAS PARA PIZZA</i> <i>PLAQUES À PIZZA</i>	93
<b>4.6 OVEN ACCESSORIES</b> <i>ACCESORIOS HORNO</i> <i>ACCESSOIRES FOUR</i>	95

# Index

## 5 Kitchen utensils

Utensilios de cocina  
Ustensiles de cuisine

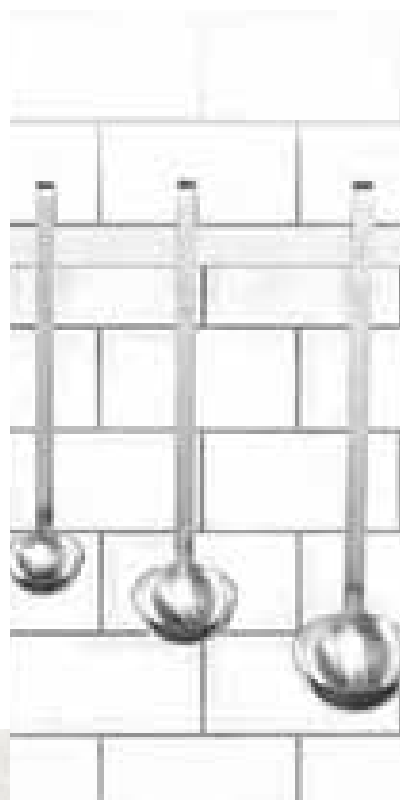

- 5.1 KITCHEN UTENSILS** 98  
UTENSILIOS DE COCINA  
USTENSILES DE CUISINE
- 5.2 MANUAL FOOD PROCESSORS** 125  
PROCESADORES MANUALES DE ALIMENTOS  
APPAREILS MANUELS DE TRANSFORMATION DES ALIMENTS
- 5.3 CUTTING BOARDS** 140  
TABLAS DE CORTE  
PLANCHES À DÉCOUPER
- 5.4 MEASURING UTENSILS** 143  
ELEMENTOS DE MEDIDA  
USTENSILES DE MESURE
- 5.5 MITT** 149  
MANOPLA  
GAN
- 5.6 NATURAL RUBBER MATS** 149  
ALFOMBRAS CAUCHO  
TAPIS EN CAOUTCHOUC

## 6 Ice-cream utensils & pastry

Heladería y pastelería  
Ustensiles à glace et pâtisserie



- 6.1 ICE-CREAM UTENSILS** 152  
UTENSILIOS HELADERÍA  
USTENSILES POUR GLACE
- 6.2 PASTRY UTENSILS** 154  
UTENSILIOS DE PASTELERÍA  
USTENSILES DE PÂTISSERIE
- 6.3 NON-STICK MOULDS** 163  
MOLDES ANTIADHERENTES  
MOULES ANTI-ADHÉSIFS
- 6.4 PASTRY CUTTER** 166  
CORTAPASTAS  
DÉCOUPOIRS
- 6.5 ST/STEEL PASTRY MOULDS** 167  
MOLDES ACERO INOXIDABLE  
MOULES EN ACIER INOX
- 6.6 BAGS AND TUBES** 170  
MANGAS Y BOQUILLAS  
POCHES ET DOUILLES
- 6.7 FLEXIPAN MOULDS** 175  
MOLDES FLEXIPAN  
MOULES FLEXIPAN
- 6.8 SILICONE MOULDS** 182  
MOLDES SILICONA  
MOULES SILICONE

## 7 Gastronorm containers

Cubetas gastronorm  
Bacs gastronorme



- 7.1 18/10 ST/STEEL** 194  
INOX 18/10
- 7.2 GASTRONORM ACCESSORIES** 198  
COMPLEMENTOS GASTRONORM  
ACCESSOIRES GASTRONORME
- 7.3 WITH SANDWICH BOTTOM** 199  
CON FONDO DIFUSOR  
AVEC FOND THERMO-DIFFUSEUR
- 7.4 SUPER PAN 3** 200
- 7.5 POLYCARBONATE** 202  
POLICARBONATO  
POLYCARBONATE
- 7.6 BISPHENOL-A FREE** 204  
SIN BISFENOL-A  
SANS BISPHÉNOL-A
- 7.7 POLYPROPYLENE** 206  
POLIPROPILENO  
POLYPROPYLÈNE
- 7.8 VIOLET COLLECTION** 208

## 8 Food delivery

Transporte de alimentos  
Transport d'aliments



- 8.1 EPP BOX** 212  
CAJA PPE  
BOÎTE PPE
- 8.2 INSULATED DELIVERY BAGS** 214  
BOLSA DE REPARTO  
SACS DE LIVRAISON ISOTHERMES
- 8.3 TRAYS AND CONTAINERS** 220  
BANDEJAS Y RECIPIENTES  
PLATEAUX ET PLATS

## 9 Dishwasher racks

Cestas para vajilla  
Cassiers à vaisselle



- 9.1 OPENED RACKS** 230  
CESTAS ABIERTAS  
CASIERS OUVERTS
- 9.2 OPENED ASSEMBLED RACKS** 232  
CESTAS MONTADAS ABIERTAS  
CASIERS MONTÉS OUVERTS
- 9.3 CLOSED ASSEMBLED RACKS** 234  
CESTAS MONTADAS CERRADAS  
CASIERS MONTÉS FERMÉS
- 9.4 COMPLEMENTS** 236  
COMPLEMENTOS  
COMPLÉMENTS
- 9.5 PLATE RACKS** 238  
CESTAS PARA PLATOS  
CASIERS ASSIETTES

## 10 Trolleys

Carros  
Chariots



- 10.1 ALUMINIUM SERVING TROLLEYS** 244  
CARROS DE SERVICIO ALUMINIO  
CHARIOTS DE SERVICE EN ALUMINIUM
- 10.2 ST/STEEL SERVING TROLLEYS** 246  
CARROS DE SERVICIO ACERO INOXIDABLE  
CHARIOTS DE SERVICE EN ACIER INOXYDABLE
- 10.3 ST/STEEL RAIL TROLLEYS** 250  
CARROS GUÍAS EN ACERO INOXIDABLE  
CHARIOTS À GLISSIÈRES EN ACIER INOXYDABLE
- 16.4 SPECIAL TROLLEYS** 257  
CARROS ESPECIALES  
CHARIOTS SPÉCIAUX



# 11 Shelving

Estanterías  
Rayonnages

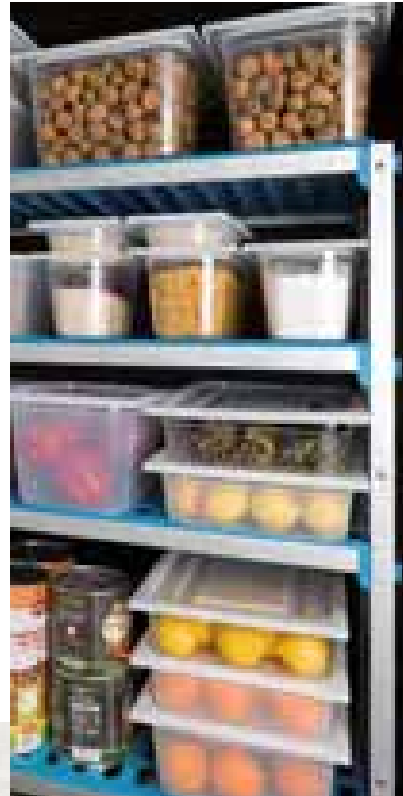

<b>11.1 COMPLETE AND ANGULAR SHELVING</b>	267
<i>ESTANTERÍAS COMPLETAS Y ANGULARES</i> RAYONNAGES COMPLETS ET ANGULAIRES	
<b>11.2 SHELVING WITH WHEELS</b>	274
<i>ESTANTERÍAS CON RUEDAS</i> RAYONNAGES AVEC ROUES	
<b>11.3 BENCH</b>	274
<i>BANCADAS</i> BANCS	
<b>11.4 PARTS</b>	275
<i>COMPONENTES</i> COMPOSANTS	
<b>11.5 BREAKDOWN OF SHELVING SETS</b>	278
<i>DESGLOSE CONJUNTOS DE ESTANTERÍAS</i> DÉCOMPOSITION KITS RAYONNAGES	

# 12 Equipment

Maquinaria  
Équipement



<b>12.1 COOKING</b>	288
<i>COCCIÓN</i> COUSSION	
<b>12.2 TOASTERS &amp; CONTACT GRILLS</b>	296
<i>TOSTADORAS Y GRILL DE CONTACTO</i> TOASTEURS ET GRILL DE CONTACT	
<b>12.3 FOOD PROCESSORS</b>	302
<i>PROCESADORES DE ALIMENTOS</i> ROBOTS MULTIFONCTION	
<b>12.4 FOOD WARMING EQUIPMENT</b>	304
<i>MAQUINARIA MANTENEDORA DE TEMPERATURA</i> APPAREILS DE MAINTEN DE TEMPEÉRATURE	
<b>12.5 ICE-CREAM MACHINES</b>	322
<i>MAQUINARIA HELADERÍA</i> TURBINES À GLACE	

# 13 Melamine

Melamina y presentación  
Melamine et présentation



<b>13 MELAMINE</b>	330
<i>MELAMINA Y PRESENTACIÓN</i> MELAMINE ET PRÉSENTATION	

# 14 Buffet & accessories

Buffet y accesorios  
Buffet et accessoires



<b>14.1 DISPLAY STANDS &amp; BASKETS</b>	386
<i>PRESENTACIÓN Y EXPOSITORES</i> PRÉSENTOIRS ET PRÉSENTOIRS CORBEILLES	
<b>14.2 PROTECTION AND COVERS</b>	394
<i>PROTECCIÓN Y TAPAS</i> PROTECTION ET COUVERCLES	
<b>14.3 BRONZE COOKWARE</b>	398
<i>BATERÍA DE COCINA BRONCE</i> BATTERIE DE CUISINE BRONZE	
<b>14.4 COOL-LINE COLLECTION</b>	400
<b>14.5 SUPER SHAPES</b>	402
<i>BUFFET PRESENTATION STEAM TABLE PANS</i> CUBETAS PRESENTACIÓN BUFFET BACS PRÉSENTATION BUFFET	
<b>14.6 MIRAMAR® COOKWARE</b>	406
<i>BATERÍA DE COCINA PARA PRESENTACIÓN</i> BATTERIE DE CUISINE-PRÉSENTATION	
<b>14.7 CUBIC</b>	412
<b>14.8 CHAFERS &amp; DISPENSERS</b>	428
<i>CHAFINGS Y DISPENSADORES</i> CHAFERS ET DISTRIBUTEURS	
<b>14.9 BOWLS &amp; SERVING TRAYS</b>	436
<i>BOLS &amp; BANDEJAS DE SERVICIO</i> BOLS & PLATEAUX	
<b>14.10 SERVING TOOLS</b>	440
<i>UTENSILIOS DE SERVICIO</i> USTENSILES DE SERVICE BUFFET	
<b>14.11 SIGNS</b>	450
<i>SEÑALIZACIÓN / SIGNALIZATION</i>	

# 15 Table service

Servicio de mesa  
Arts de table



<b>15.1 MINIATURES</b>	454
<i>MINIATURAS</i> MINIATURES	
<b>15.2 TABLE PRESENTATION</b>	462
<i>PRESENTACIÓN DE MESA</i> PRÉSENTATION TABLE	
<b>15.3 TABLE SERVICE</b>	479
<i>SERVICIO DE MESA</i> SERVICE DE TABLE	

# 16 Bar & coffee

Bar y cafetería  
Bar et cafétéria



<b>16.1 BEVERAGE TROLLEY</b>	488
<i>CARRO BEBIDAS</i> TCHARIOT BOISSON	
<b>16.2 BAR</b>	491
<b>16.3 TEA &amp; COFFEE SERVICE</b>	502
<i>TÉ Y CAFETERÍA</i> THÉ ET CAFÉTERIA	
<b>16.4 BEVERAGE SERVICE</b>	506
<i>SERVICIO DE BEBIDAS</i> SERVICE À BOISSONS	
<b>16.5 LIDSAVERS AND CUPDISPENSERS</b>	510
<i>DISPENSADORES DE TAPAS Y VASOS</i> DISTRIBUTEUR DE COUVERCLES ET GOBELETS	

**N** **New**  
 Novedades  
 Nouveauté

**Grill**

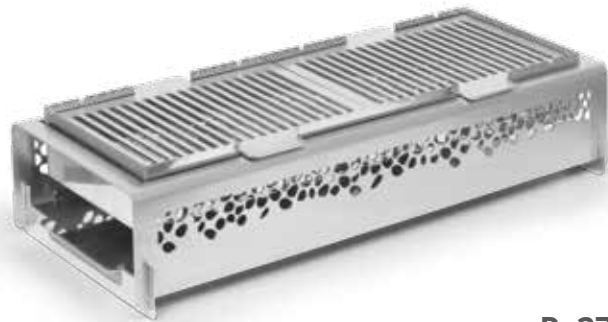

P. 27



P. 32



P. 28



P. 33



P. 36



P. 30

**Tribute**



P. 42

**4-Series**



P. 289

**Easy open**



P. 197

**STOELTING**  
 A VOLLRATH BRAND

**Ice-cream and beverage solutions**  
 Soluciones para la heladería  
 Solutions pour glaciers



P. 322



P. 255

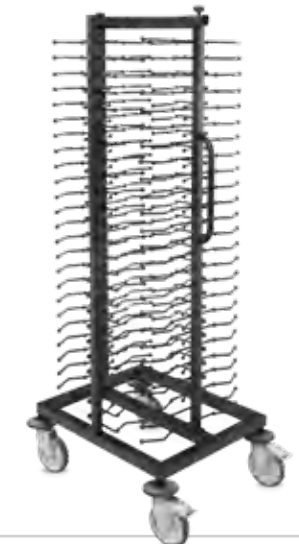

P. 257

# Melamine





P. 462

**Buffet**



P. 398



P. 388



P. 386



P. 459



P. 458



P. 470



P. 357

**Beverage trolley**



P. 490



P. 488



P. 480



P. 454



P. 491

# 1 Grill

Brasa  
Braise



**1.1 GRILLBOX** 26

**1.2 CHARCOAL OVENS** 29  
*HORNO DE BRASA*  
*FOUR À BRAISE*

**1.3 SMOKER** 32  
*AHUMADOS*  
*FUMÉS*

**1.4 ACCESSORIES** 34  
*ACCESORIOS*  
*ACCESSOIRES*

**1.5 GRILL COOKWARE** 36  
*MENAJE BRASA*  
*MATÉRIEL À BRAISE*

# Oven operation

Funcionamiento horno  
Fonctionnement du four

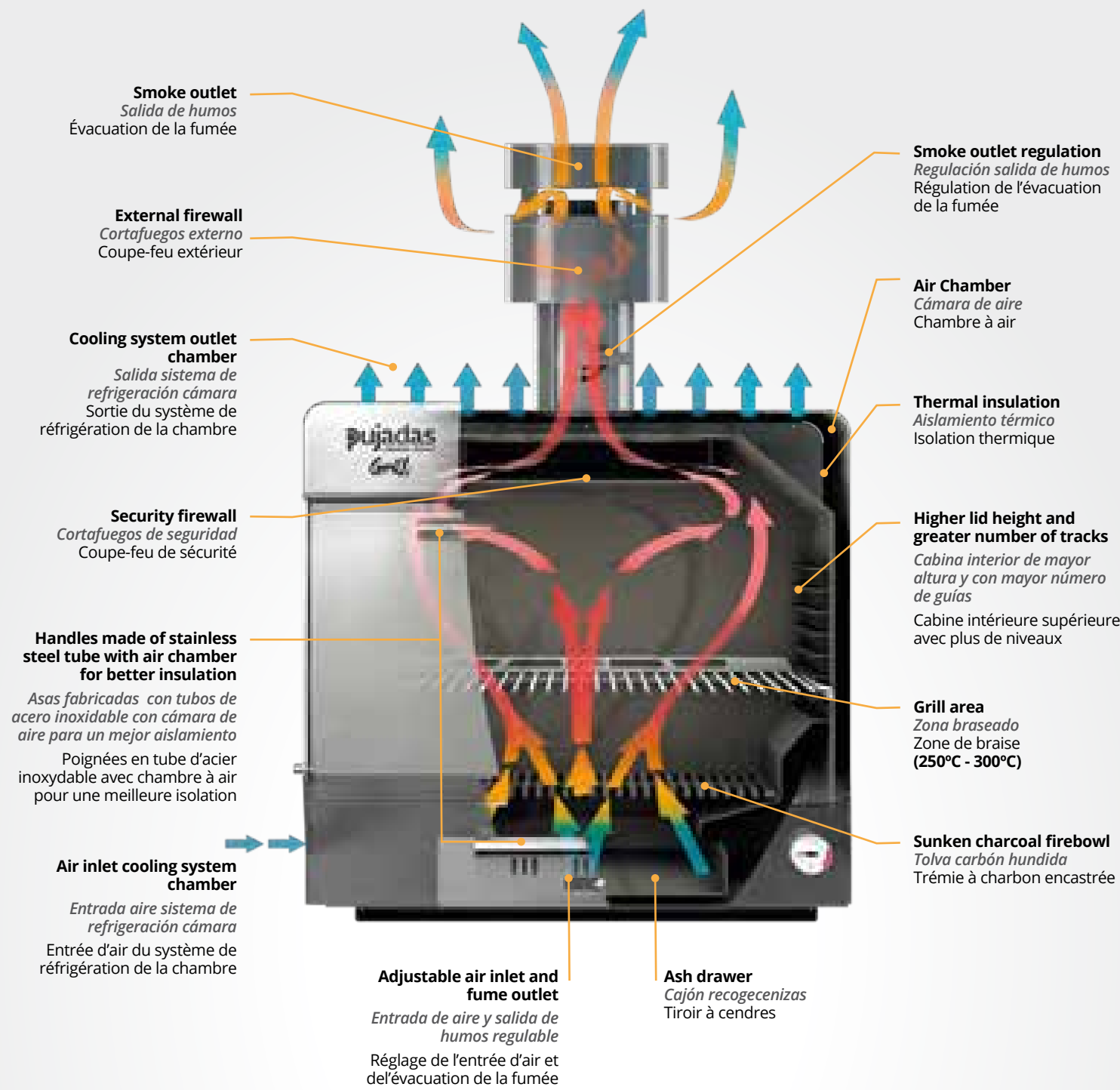

- **Greater power and efficiency. A way to cook faster, cleaner and healthier.**
- **No need to connect to a power source.**
- **Depending on the number of services, improves the energy cost.**
- **The high calorific value of charcoal increases its efficiency: with a small amount of charcoal, the temperature increases quickly and reaches a point suitable for cooking in less than 10 minutes.**
- **Allows you to control the cooking temperature thanks to the upper and lower air flow regulators.**
- **Fast return on investment (2.5 years approximately).**

- **Mayor potencia y eficiencia. Una forma de cocinar más rápida, limpia y saludable.**
- **No es necesario conectar a la corriente.**
- **Según el número de servicios, mejora el coste de la energía.**
- **El alto poder calorífico del carbón incrementa su eficiencia: con poca cantidad de carbón aumenta la temperatura rápidamente y llega al punto apto para cocción en menos de 10 minutos.**
- **Permite controlar la temperatura de cocción gracias a los reguladores de caudal de aire superior e inferior.**
- **Rápido retorno de la inversión (2,5 años aproximadamente).**

- **Puissance et efficacité accrues. Une façon de cuisiner plus rapide, plus propre et plus saine.**
- **La connexion à l'alimentation n'est pas nécessaire.**
- **Selon le nombre de services, réduit la dépense énergétique.**
- **Le haut pouvoir calorifique du charbon augmente son efficacité : une petite quantité de charbon suffit pour augmenter la température rapidement et atteindre le point de cuisson approprié en moins de 10 minutes.**
- **Permet de contrôler la température de cuisson grâce aux régulateurs de débit d'air supérieur et inférieur.**
- **Retour sur investissement rapide (2,5 ans environ).**



## Comparison of consumption according to energy source

Comparativa de consumo según fuente energética  
Comparaison des consommations selon la source d'énergie

OVEN TYPE TIPO HORNO TYPE FOUR	Dimensiones Dimensions Dimensions cm (W x D x H)	Power Potencia Puissance KW	Consumption Consumo Consommation	Cost Gasto Dépense € / hour / hora / heure	Difference Diferencia Différence PJD OVEN 90	Difference Diferencia Différence PJD OVEN 140
<b>ELECTRIC</b> ELÉCTRICO ÉLECTRIQUE	90 x 68 x 80	6	6 KW/h	1,01	-36%	-10%
<b>GAS</b> GAS GAZ	90 x 68 x 80 73 x 60 x 80 86 x 62 x 80	8	0,85 m <sup>3</sup>	1,12	-42%	-19%
<b>CHARCOAL</b> CARBÓN À BRAISE	<b>OVEN 90</b> 71 x 58 x 69	10,8 (Marabú)	5 kg / 4h	0,65	-	-
<b>CHARCOAL</b> CARBÓN À BRAISE	<b>OVEN 140</b> 87 x 78 x 87	15,1 (Marabú)	7 Kg / 4h	0,91	-29%	-

Calculations may vary according to the energy tariffs in different countries  
Los cálculos pueden variar según las tarifas energéticas de los diferentes países  
Les calculs peuvent varier en fonction du prix de l'énergie des différents pays.

# 1.1 GRILLBOX



**Just the way you like it**

*A tu gusto, a tu ritmo / À votre goût, à votre rythme*

High-quality stainless steel mini grill  
 Mini parrilla acero inox de alta calidad  
 Mini grill acier inox de haute qualité

Charcoal container  
 Carbonera  
 Espace charbon

High-quality stainless steel reinforced casing.  
 Prevents heat leakage during preparation.  
 Carcasa reforzada acero inox de alta calidad.  
 Impide la fuga de calor durante la preparación.  
 Carcasse renforcée en acier inoxydable de haute qualité.  
 Empêche la perte de chaleur pendant la préparation.

High-quality stainless-steel base.  
 Low weight for easy transport.  
 Base de acero inox de alta calidad.  
 Peso reducido para facilitar su transporte.  
 Base en acier inoxydable de haute qualité.  
 Poids léger pour faciliter son transport.

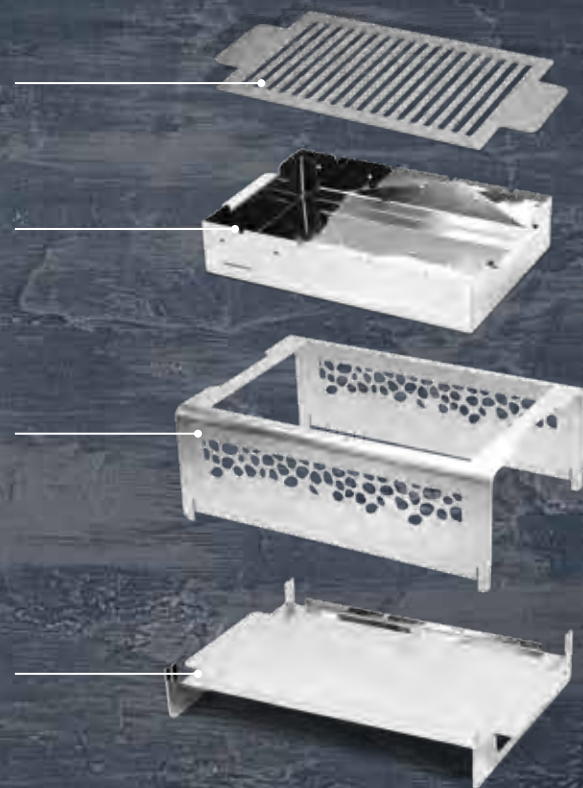

**P85200** Stainless steel tabletop barbecue  
 Barbacoa sobremesa acero inox  
 Barbecue de table acier inox



REF	W x D x H cm	
P85200	37 x 26 x 15	1

**P85220** Stainless Steel tabletop barbecue Duo  
 Barbacoa de sobremesa Duo acero inoxidable  
 Barbecue de table Duo en acier inoxydable

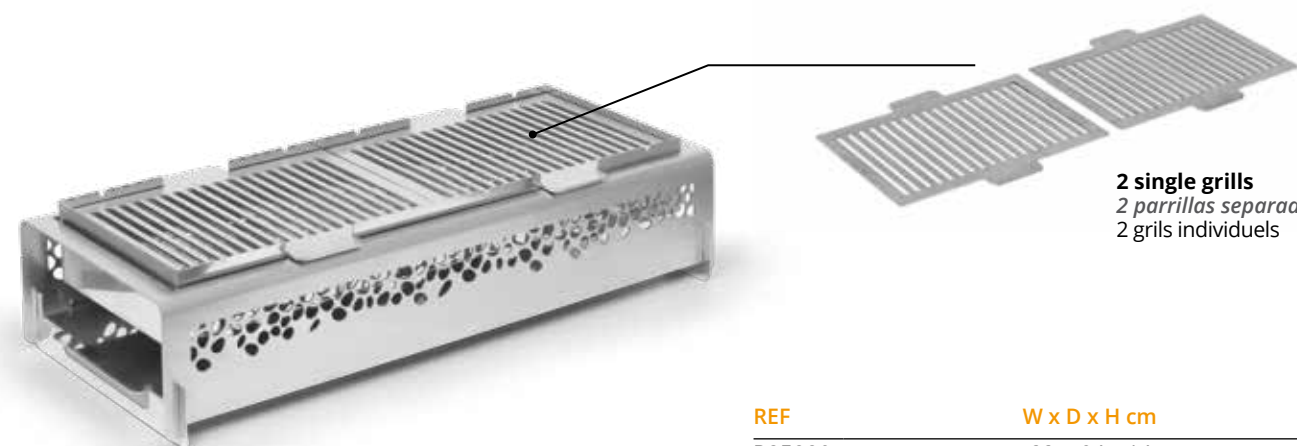

**2 single grills**  
 2 parrillas separadas  
 2 grils individuels

REF	W x D x H cm	
P85220	66 x 24 x 14	1

# 1.1 GrillBox



## Optional accessories Complementos opcionales Accessoires en option

### 2960001 Stainless steel tray

Llauna inox  
Plaque inox



REF	W x D x H cm	
2960001	29,5 x 19,5 x 2	1

### P85201 Basalt stone

Piedra de basalto  
Pierre de basalte



REF	W x D x H cm	
P85201	28,7 x 18,7 x 2	1

### P968130 Skewer

Pincho  
Brochette

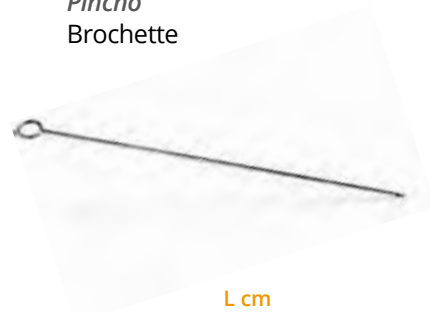

REF	L cm	
P968130	30	12

### P85223 Gripper

Pala  
Pelle



REF	L cm	
P85223	30	12

### P85221 Chimney

Chimenea  
Cheminée



REF	W cm	H cm	
P85221	18	30	1

### P85222 GrillBox lid

Tapa GrillBox  
Couvercle GrillBox



REF	W x D x H cm	
P85222	29,5 x 20 x 8	1

All accessories suit to GrillBox and GrillBox Duo  
Todos los accesorios se adaptan a GrillBox y GrillBox Duo  
Tous les accessoires sont compatibles avec GrillBox et GrillBox Duo

# Charcoal ovens 1.2

Horno brasa  
Four à braise



MADE OF HIGH-QUALITY STAINLESS STEEL  
FABRICADOS EN ACERO INOXIDABLE DE ALTA CALIDAD  
FAITS D'ACIER INOXYDABLE DE HAUTE QUALITÉ

## OVEN50



40 - 50  
diners  
comensales  
couverts

## OVEN90



80 - 90  
diners  
comensales  
couverts

## OVEN140



130-140  
diners  
comensales  
couverts

REF	Dimensions Dimensiones Dimensions cm (W x D x H)	Grill Parrilla Gril cm	Produc. Kg/h	Temp. Rec. Cooking Temp. rech. cuisson. °C	Power Equiv. Pot. Equiv. Puisse. Equiv. KW	Consum. Consumo Consum. Kg/ day / día / jour	Charcoal load Carga carbón Charge de charbon Kg	Weight Peso Poids Kg	Colour Color Couleur	
OVEN50	P85050SS									
	P85050R	70 x 55,5 x 62	58 x 36,7	30	250-350	3.2	3	5	145	1
	P85050B									
OVEN90	P85090SS									
	P85090R	70 x 65,5 x 72	58 x 46,7	70	250-350	4	5	7	180	1
	P85090B									
OVEN140	P85140SS									
	P85140R	89 x 84 x 88	76,6 x 64,8	100	250-350	4.6	6	9	240	1
	P85140B									

### Each oven comes with

Cada horno se entrega con / Chaque four est livré avec:

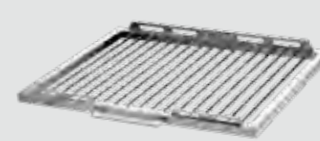

- 1 stainless steel grill
- 1 parrilla de acero inoxidable
- 1 grille en acier inoxydable



- 1 tong
- 1 pinza
- 1 pince



- 1 ash shovel
- 1 pala recoge cenizas
- 1 pelle pour ramasser les cendres



- 1 charcoal poker
- 1 atizador de carbón
- 1 tisonnier à charbon



- 1 metallic brush
- 1 cepillo metálico
- 1 brosse métallique



# 1.2 Charcoal ovens

Horno brasa  
Four à braise

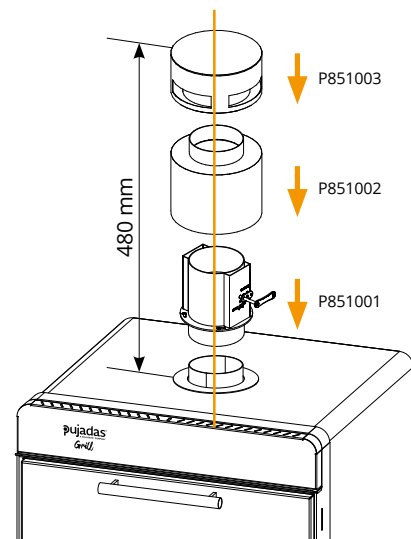

**P851003** Hat filter  
Filtro sombrero  
Filtre chapeau supérieur



REF	Quantity
P851003	1

**P851002** External cutter flame  
Cortafuegos externo  
Coupe-feu externe



REF	Quantity
P851002	1

**P851001** Upper air flow regulator  
Regulador de tiro superior  
Régulateur de sortie de fumée



REF	Quantity
P851001	1

**P85050CP** Stainless Steel Hot Plate  
Support Chauffe - Plats Inox  
Grille Chauffer acier inox

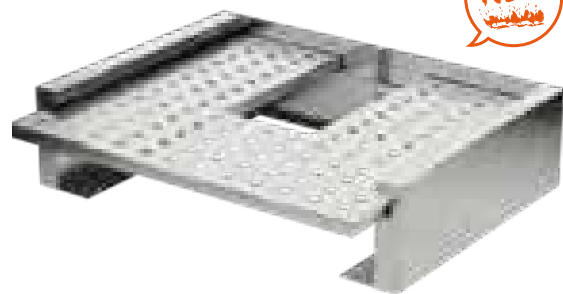

REF	W x D x H cm	Quantity
P85050CP	77,7 x 46,1 x 21,5	1
P85090CP	63,6 x 56,1 x 21,5	1
P85140CP	82 x 74,4 x 21,5	1

**RE8505004** Stainless steel oven rack  
Parrilla varilla inox horno  
Grille en acier inoxydable



REF	Oven / Horno / Four	cm	Quantity
RE8505004	50	58,5 x 38,5	1
RE8509007	90	58,5 x 48,5	1
RE8514007	140	77,5 x 65,5	1

# Charcoal ovens 1.2

Horno brasa  
Four à braise



**P85090** Oven table - Oven 90  
Mesa para horno Oven 90  
Table pour four Oven 90



P85090MP



P85090MT



Available with wheels  
Disponible con ruedas  
Disponible avec roues

REF	w/wheels con ruedas avec roues	cm W x D x H	Quantity
P85090MT	✗	67 x 55 x 90	1
P85090MP	✗	68 x 55 x 95	1
P85090MTR	✓	67 x 55 x 85	1
P85090MPR	✓	68 x 55 x 90	1

**P85140** Oven table - Oven 140  
Mesa para horno Oven 140  
Table pour four Oven 140



P85140MP



P85140MT



Available with wheels  
Disponible con ruedas  
Disponible avec roues

REF	w/wheels con ruedas avec roues	cm W x D x H	Quantity
P85140MT	✗	87 x 73,5 x 77	1
P85140MP	✗	88 x 73,5 x 82	1
P85140MTR	✓	87 x 73,5 x 82	1
P85140MPR	✓	88 x 73,5 x 77	1

# 1.3 SMOKER

The smoking technique is a growing trend not only for the culinary preparations of the most prestigious chefs but also for all those who prioritize innovation and originality in their menus.

Easily, quickly and efficiently achieve totally cold smoke, much more aromatic and stable over time, and suitable for sauces, oils, meats, fish, cheeses, rice dishes or even cocktails.

La técnica del ahumado es una tendencia al alza no sólo para las elaboraciones culinarias de los más prestigiosos chefs sino de todos aquellos que priman la innovación y originalidad en sus preparaciones.

Consigue humos totalmente fríos, mucho más aromáticos y estables en el tiempo para tus salsas, aceites, carnes, pescados, quesos, arroces o incluso cocktails de manera fácil, rápida y eficaz.

La technique du fumage est une tendance à la hausse non seulement pour les élaborations culinaires des chefs les plus prestigieux, mais aussi pour tous ceux qui privilégient l'innovation et l'originalité dans leurs préparations.

Obtenez des fumées totalement froides, beaucoup plus aromatiques et stables dans le temps pour vos sauces, huiles, viandes, poissons, fromages, riz ou même cocktails de façon facile, rapide et efficace.

**Smoking Gun**  
Pistola para aromatizar  
Fumoir

**Tank for burner**  
Depósito para quemador  
Réservoir pour brûleur

**Support for the Gun**  
Soporte para el aromatizador  
Support pour l'aromatiseur

**Smoking Valve**  
Válvula para aromatizar  
Vanne aromatisante

**Burner**  
Quemador  
Brûleur

**\*Highly resistant to large-scale work volumes**  
\*Altamente resistente a grandes volúmenes de trabajo  
\*Très résistante aux grands volumes de travail



## PUJADAS KITCHENWARE FOR SMOKING AND FLAVOUR MENAJE PUJADAS PARA AHUMAR Y AROMATIZAR USTENSILES DE CUISINE PUJADAS POUR FUMER ET AROMATISER



**Food silicone valves with self-closing system that allow the entry of flavoured smoke without leaks, and preserving all food essence.**

Válvulas de silicona alimentaria con autocierre que permiten la entrada del humo aromatizado sin fugas/escapes, preservando toda su esencia.

Valves en silicone alimentaire à fermeture automatique qui permettent l'entrée de fumée aromatisée sans fuites / pertes, préservant toute son essence.



**Adapt the lids of your blenders and get unique preparations and creations.**

Adapta las tapas de tus blenders y consigue elaboraciones y creaciones únicas.

Adaptez les couvercles de vos blenders et obtenez des préparations et créations uniques



# Smoker 1.3

Ahumados  
Fumoir



**P85230 Smoker**  
Ahumador  
Fumoir



REF	W x D x H cm	
P85230	5,5 x 12,5 x 16	1

**P110004A GN hermetic lid for smoking**  
Tapa hermética GN para ahumar  
Couvercle hermétique GN pour fumer

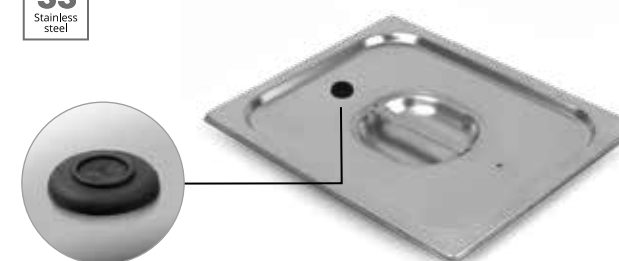

REF	GN	cm	
P110004A	1/1	53 x 32,5	1
P120004A	1/2	32,5 x 26,5	1

**Ideal for cold smoking large pieces of meat or whole fish. Adaptable to all 1/1 & 1/2 GN containers.**

Ideal para ahumar en frío piezas grandes de carne y pescado enteras. Adaptable a todas las cubetas GN 1/1 y 1/2.

Idéal pour fumer à froid de gros morceaux de viande ou poisson entier. Adaptable à Tous les bacs GN 1/1 et 1/2.

**P209020A Cookware inox lid for smoke**  
Tapa batería inox para ahumar  
Couvercle de batterie en acier inoxydable pour fumer



REF	Ø cm	
P209020A	20	1
P209024A	24	1
P209028A	28	1
P209032A	32	1

**Lid with smoke valve for preparations such as sauces, stews, etc.**

Tapa con válvula de ahumado para elaboraciones como salsas, cocidos, etc.

Couvercle avec valve de fumage pour les élaborations telles que les sauces, les ragoûts, etc.

**P1540 Glass lid for smoking**  
Tapa de cristal para ahumar  
Couvercle en verre pour fumer



REF	Ø cm	
P154020	20	1
P154024	24	1
P154028	28	1
P154032	32	1

**Lid with smoke valve for preparations such as sauces, stews, etc.**

Tapa con válvula de ahumado para elaboraciones como salsas, cocidos, etc. Couvercle avec valve de fumage pour les élaborations telles que les sauces, les ragoûts, etc.

**P85231 Chips beech and oak**  
Chips aroma haya y roble  
Chips d'arôme de hêtre et de chêne



REF	Ø cm	H cm	gr	
P85231	7,5	9	80	1
P85232	7,5	9	80	1

# 1.4 Accessories

Accesorios  
Accessoires

## P850000 Charcoal top quality Marabú Carbón vegetal Marabú primera calidad Charbon de bois Marabú de qualité supérieure

- High calorific performance.
- A good mix of lumpwood and broken charcoal pieces.
- Coarse-grained, dust-free charcoal.
- 10 Kg bag with handle for easy transport and handling.
- Bag made of plasticized raffia to prevent soot from escaping.

- Alto rendimiento calorífico.
- Buena mezcla de roturado y canelino.
- Carbón de granulometría gruesa y sin polvo.
- Saco de 10 kg con asa para su fácil transporte y manejo.
- Saco fabricado en rafia plastificada para evitar el escape de hollín.

- Puissance calorifique élevée.
- Bonne proportion de roturado et canelino.
- Charbon grosse granulométrie et sans poussière.
- Sac de 10 kg avec poignée pour un transport et une manipulation faciles.
- Sac fabriqué en raphia plastifié pour éviter la perte de suie.



Sale unit: 1 pallet including 28 10Kg charcoal bags

Unidad de venta: 1 palet 28 sacos de 10Kg. de carbón

Unité de vente: 1 palette 28 sacs de 10Kg. de charbon de bois

REF	Wood type Tipo de madera Type de bois	Calorific value Poder calorífico Puissance calorifique Kcal/Kg	Granulometry Granulometría Granulométrie mm	Carbon Carbón Carbone %	Ashes Cenizas Cendres %	Humidity Humedad Humidité %	Density Densidad Densité Km/m <sup>3</sup>	Bag weight Peso saco Poids sac Kg
P850000	Marabú	≈ 8000	150	> 75	< 5	< 6	298	10

## P850101 Oak chunks Tacos de madera de roble Morceaux de chêne



REF	Kg	
P850101	± 4	1

## P850102 Sherry aromatic oak chips Astillas de roble con aroma fino Copeaux de chêne à l'arôme de xérès



Chips from authentic macerated barrel  
Astillas de auténtica barrica macerada  
Copeaux d'authentiques barriques macérées

REF	Kg	
P850102	± 2	1

## P850104 Whisky aromatic oak chips Astillas de roble con aroma whisky Copeaux de chêne à l'arôme de whisky



Chips from authentic macerated barrel  
Astillas de auténtica barrica macerada  
Copeaux d'authentiques barriques macérées

REF	Kg	
P850104	± 2	1

100% natural  
100% natural / 100 % naturel

Add subtle nuances and aromas to your recipes with the age-old technique of smoking. Aromatize the embers before starting with the elaboration so your dishes will get new tastes.

Agrega sutiles matices y aromas a tus recetas con la técnica milenaria del ahumado. Aromatiza la brasa antes de empezar con la elaboración, así tus platos conseguirán nuevos sabores que sorprenderán.

Ajoutez des nuances et des arômes subtils à vos recettes grâce à la technique ancestrale du fumage. Parfumez les braises avant de commencer la cuisson, de cette façon vos plats obtiendront de nouveaux arômes et goûts.

# Accessories 1.4

Accesorios  
Accessoires

## P851004 Heavy duty oven tong Pinza reforzada horno Pince renforcée pour four



REF	cm	
P851004	33,5	120

## P851007 Metallic brush Cepillo metálico Brosse métallique

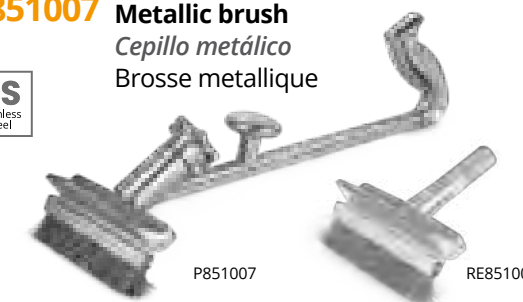

REF	L cm	
P851007	23,5	1
RE851008	23,5	1

## P851005 Oven poker Pala atizadora horno brasa Tisonnier pour four à braise



REF	cm	
P851005	64,5	1

## P851006 Collect ashes shovel Pala recogecenizas Pelle à cendres



REF	W x D x H cm	
P851006	14,5 x 38,5 x 13	1

## 478 Stainless steel tong Pinza de acero inoxidable Pince inoxydable

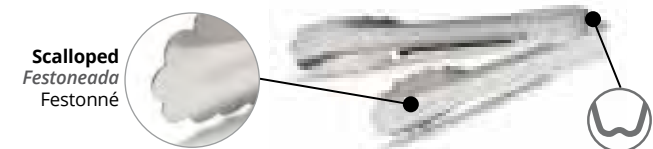

REF	L cm	
4781210	30,5	12
4781610	40,6	12

## 479 VERSAGRIP® Stainless steel tong Pinza VERSAGRIP® de acero inoxidable Pince inox VERSAGRIP®

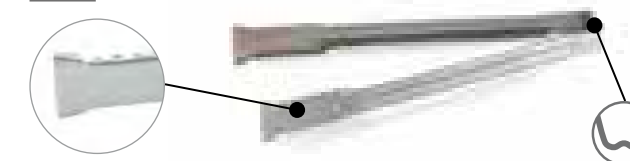

REF	L cm	
4791210	30,5	12
4791610	40,6	12

## P968 Carry-skewers Porta pinchos Porte-brochettes



REF	Ø cm	H cm	
P968000	22	46	1

## P9681 Skewer Pincho Brochette



Compatible with skewer racks P85090SP and P85140SP  
Compatible con soporte pinchos P85090SP y P85140SP  
Compatible avec les supports de brochettes P85090SP et P85140SP

REF	L cm	
P968135	35	12

# 1.5 Grill cookware

Menaje brasa  
Matériel à braise

**P851030 Grill fry pan**  
Sartén perforada grill  
Poêle perforée



REF	Ø cm	H cm	
P851030	30	5	4



**Ø 8mm holes**  
Agujeros de Ø 8 mm  
Trous de Ø 8 mm

**2 mm thickness**  
2 mm de grosor  
2 mm d'épaisseur

**Resistant to high temperatures.**  
Resistente a altas temperaturas.  
Résistants aux températures élevées



**Carbon Steel with cast iron handle**  
Acero al carbono y mango de hierro fundido  
Acier au carbone avec manche en fonte de fer

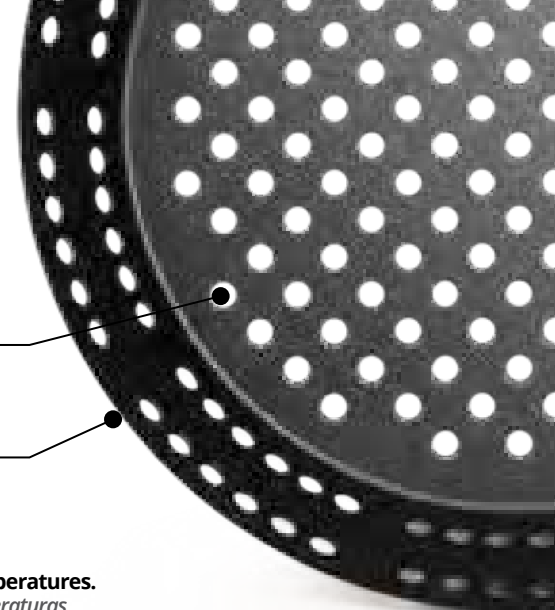

**P852030 Grill wok**  
Wok perforado grill  
Wok grill perforé



REF	Ø cm	H cm	
P852030	30	9	4

**P853030 Grill pan**  
Bandeja perforada grill  
Plaque perforée grill



REF	W x D x H cm	
P853030	38 x 26 x 5,5	4

See products on  
Ver productos en / Voir produits en page

P. 78

**Black Pro**



# Grill cookware 1.5

Menaje brasa  
Matériel à braise

See products on  
Ver productos en / Voir produits en page

P. 83

**Steel Classic**



See products on  
Ver productos en / Voir produits en page

P. 81

**Steel Pro 1921 Series**



See products on  
Ver productos en / Voir produits en page

P. 88

**Roast pan**  
Rustidera  
Plaque à rôtir



See products on  
Ver productos en / Voir produits en page

P. 465

**Tin plates display**  
Llaunas presentación  
Plateaux inox présentation



See products on  
Ver productos en / Voir produits en page

P. 460

**Cast iron miniatures**  
Miniaturas hierro fundido  
Miniatures fonte émaillée



See products on  
Ver productos en / Voir produits en page

P. 60

**Black Series**



See products on  
Ver productos en / Voir produits en page

P. 84

**Spanish paella pan & Deep enamelled fry pan**  
Paellera y Sartén Honda  
Plat à paella et poêle haute



# 2 Cookware

Batería de Cocina  
Batterie de Cuisine

























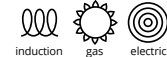





<b>2.1</b>		<b>TRIBUTE</b>	42
<b>2.2</b>		<b>INOX-PRO</b>	46
<b>2.3</b>		<b>COOL-LINE</b>	54
<b>2.4</b>		<b>CENTURY</b>	56
<b>2.5</b>		<b>BLACK SERIES</b>	60
<b>2.6</b>		<b>BLACK FORGED</b>	61

# Which cookware do you need?

¿Qué batería necesitas?  
Quel batterie de cuisine vous faut-il ?

## Stainless Steel Acero Inoxidable Acier Inox

## Aluminium Aluminio Aluminium

	TRIBUTE	INOX-PRO	COOL • LINE	CENTURY	BLACK SERIES	BLACK FORGED
						
	P. 42	P. 46	P. 54	P. 56	P. 60	P. 61
COMPATIBLE WITH COMPATIBLE CON COMPATIBLE AVEC	 <b>INDUCTION</b>	 <b>INDUCTION</b>	 <b>INDUCTION</b>	 <b>NO INDUCTION</b>	 <b>NO INDUCTION</b>	 <b>INDUCTION</b>
						
PRICE PRECIO PRIX						
WARRANTY YEARS GARANTÍA AÑOS GARANTIE ANNÉES	1,5	5	4	1	2	2
CERTIFICATION CERTIFICACIÓN CERTIFICATION						
HANDLES ASAS ANSES	<b>WIRE</b> VARILLA FILS	<b>WIRE</b> VARILLA FILS	<b>CAST</b> FUNDICIÓN FONTE	<b>TUBULAR</b> TUBULAR TUBULAIRE	<b>INTEGRATED</b> INTEGRADO INTÉGRÉ	<b>INTEGRATED</b> INTEGRADO INTÉGRÉ
RESTAURANT RESTAURANTE RESTAURANT	<b>ANY KIND</b> TODO TIPO TOUS TYPOS	<b>ANY KIND</b> TODO TIPO TOUS TYPOS	<b>GOURMET</b>	<b>TRADITIONAL</b> TRADICIONAL TRADITIONNEL	<b>TRADITIONAL AND PRESENTATION</b> TRADICIONAL Y PRESENTACIÓN TRADITIONNEL ET PRESENTATION	<b>TRADITIONAL</b> TRADICIONAL TRADITIONNEL
MEASURES Ø MEDIDAS Ø MESURES Ø	12-35	12-60	16-32	16-60	16-40	16-28

# 2.1 TRIBUTE

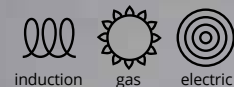

**Stainless steel cover with a welded all-natural antimicrobial dipped handle.**

*Tapa de acero inoxidable con asa antimicrobial natural completamente soldada.*

Couvercle en acier inoxydable avec poignée antimicrobienne naturelle complètement soudée.

**Handle design offers a comfortable, ergonomic grip and minimizes heat transfer. Silicone TriVent handle withstands temperatures up to 450°F.**

*El diseño del mango ofrece un agarre cómodo y ergonómico y minimiza la transferencia de calor. El mango TriVent de silicona soporta temperaturas de hasta 232 °C.*

La conception du manche offre une prise en main confortable et ergonomique et minimise le transfert de chaleur. Le manche TriVent en silicone résiste à des températures allant jusqu'à 232 °C.

**Welded handles ensure a secure connection. Ever-Tite riveting system promises a lifetime limited warranty against loose rivets.**

*Los puntos de soldadura de las asas garantizan una sujeción segura. El sistema de remachado Ever-Tite ofrece una garantía de por vida.*

Les points de soudure des poignées assurent une prise en main sûre. Le système de rivetage Ever-Tite offre une garantie à vie.

**3-ply construction is durable and maintains shape. 3004-Series aluminum core for even heating across the bottom and walls.**

*Composición Tri Capa que alarga la vida útil en la forma y aplicación del producto. El núcleo en aluminio de la serie 3004 permite una transmisión uniforme del calor en la parte interior y paredes de la batería.*

Composition triple couche qui prolonge la durée de vie utile dans la forme et l'application du produit. Le centre en aluminium de la série 3004 permet une transmission uniforme de la chaleur à l'intérieur et sur les parois de la batterie.

**18-10 grade stainless steel exterior is induction-ready.**

*La aleación de acero inoxidable 18/10 aporta al producto un uso apto para inducción.*

Grâce à l'alliage d'acier inoxydable 18/10 le produit est adapté à l'induction.



# Tribute by VOLLRATH

## 3-ply cookware body Cuerpo tricapa Corps triple couche



Stainless steel 18/8  
Inox 18/8

Aluminium 3004  
Aluminio 3004

Stainless steel 18/8  
Inox 18/8



Others



Multimetal

The professional Tribute® Kitchenware set is Vollrath's the high-end option.

It's 3-ply design, from base to sides, is composed of three high-quality materials:

- Interior coating, over the entire cooking surface, in 18/8 stainless steel, which is color and flavor neutral.
- A 3004 aluminum core which guarantees a perfectly uniform heat distribution.
- An easy-to-clean and durable 18/10 stainless steel exterior.

La batería profesional Tribute® es la elección de alta gama de Vollrath, especialmente diseñada para el alto rendimiento en cocina.

Su cuerpo tri-capa, desde la base hasta los laterales, está compuesto por tres materiales de alta calidad:

- Un revestimiento interior, por toda la superficie de cocción, de acero inoxidable 18/8 que mantiene intactos los sabores y colores de los alimentos.
- Un centro de aluminio 3004 que garantiza una distribución perfectamente uniforme del calor.
- Un exterior de acero inoxidable 18/10 de fácil limpieza y alta resistencia.

La batterie professionnelle Tribute® est le choix haut de gamme de Vollrath, spécialement conçue pour la haute performance en cuisine.

Son corps triple couche, sur la base et les latéraux, est composé de trois matériaux haut de gamme :

- Un revêtement intérieur, sur toute la surface de cuisson, en acier inoxydable 18/8 qui garde intacts les saveurs et les couleurs des aliments.
- Un centre en aluminium 3004 garantit une distribution parfaitement uniforme de la chaleur.
- Un extérieur en acier inoxydable 18/10 facile à nettoyer et très résistant.

**JP LIFETIME GUARANTEE**

Vollrath is dedicated to keeping your operation running smoothly, which is why we offer a lifetime warranty on so many of our products.

Note: Jacob's Pride® warranty does not cover plastisol coating on handle.

Vollrath se dedica a mantener su operación funcionando sin problemas, razón por la cual ofrecemos una garantía de por vida en muchos de nuestros productos.

Nota: El certificado de garantía Jacob's Pride® no cubre el revestimiento de plastisol en el mango.

Vollrath se consacre à assurer le bon fonctionnement de votre activité, raison pour laquelle nous offrons une garantie à vie sur plusieurs de nos produits.

Note: La garantie Jacob's Pride® ne couvre pas le revêtement en plastisol sur la poignée.



# Tribute 2.1

## 775 Stock pot Olla recta Marmite traiteur



REF	Ø cm	H cm	Lts	☐
77519	22	5,6	14,6	1
77520	24	7,5	15,2	1
77521	30	11,4	15,9	1
77522	30	15,1	21,6	1
77523	35	18,9	19,7	1

## 7776 Sauce Pot Cacerola alta Braisière



REF	Ø cm	H cm	Lts	☐
77760	12	13,7	9,4	1
77761	14	14,2	14,1	1

## 77750 Rounded saucepan Cazo bombeado Casserole bombée



REF	Ø cm	H cm	Lts	☐
77750	28	8,9	4,5	1

## 777 Sauce Pan Cazo recto Casserole



REF	Ø cm	H cm	Lts	☐
77739	16	7,6	1,4	1
77740	18	8,9	2,4	1
77741	20	10,5	4,2	1
77742	22	10,5	4,2	1

## 693 Lid Tapa Couvercle



REF	Ø cm	☐
69325	16	1
69328	20	1
69329	22	1
69410	24	1
69412	30	1
69414	32	1

See products on  
Ver productos en / Voir produits en page

P. 69

## Tribute fry pan Sartén Tribute Poêl Tribute





# 2.2 INOX-PRO

COOKWARE  
BATERIA  
BATTERIE

**Cookware body made of 18/10 stainless steel**  
Cuerpo en acero inoxidable 18/10  
Corps en acier inoxydable 18/10

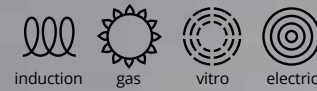

**Specially designed to achieve the best performance in the professional cooking**  
*Diseñada para ofrecer el mayor rendimiento en la cocina profesional*  
Conçue pour offrir le plus haut rendement dans la cuisine professionnelle



**Efficacy**  
*Eficacia*  
Efficacité



**Safety : welded handles by build-up process**  
*Segura: asas soldadas por aportación de materiales*  
Sécurité : soudures des anses par résistance

**Solid and robust: st/steel wire handle ultra-resistant, 500kg.**



*Sólida y robusta: asas de varillas matizada en inox ultrasensibles, 500 kg.*

*Solide et robuste : anses en fil inox ultra-résistantes, 500kg.*

**Warranty: control of all production processes**  
*Garantía: control de todos los procesos de fabricación*  
Garantie : contrôle de tous les processus de production

**Quality: inner and outer sides of all models with uniform satin polishing**

*Calidad: pulido satinado interior y exterior uniforme en todos los modelos*

*Qualité : polissage satiné uniforme à l'intérieur et l'extérieur de tous les modèles*

**Radius specially designed for easy and fast cleaning**  
*Radios interiores diseñados para una limpieza fácil y rápida*  
Rayons permettant un entretien facile et rapide

**Control: handcrafted welding and checking every unit**  
*Control: soldadura artesanal e inspección en cada unidad*  
Contrôle : soudure artisanale et vérification de chaque unité

**Unique: origin identification and type of cooking system**  
*Única: identificación de origen y tipo fuente de calor*  
Unique : identification de l'origine et type de système de cuisson

**Efficient: lids designed to save energy**  
*Eficiente: tapas diseñadas para el ahorro de energía*  
Efficace : couvercles conçus pour économiser de l'énergie

**Induction: technical sandwich base (stainless steel - aluminium - stainless steel)**

*Inducción: fondo sandwich técnico (inox - alu - inox)*

*Induction : fond sandwich technique inox - alu - inox)*



**Cookware is sold without lids.**  
*Las baterías de cocina se venden sin tapa.*  
Les batteries de cuisine sont-elles vendues sans couvercle.

## 2.2 Inox-Pro



**P218** Stock pot without lid  
*Olla recta sin tapa*  
Marmite traiteur sans couvercle



REF	Ø cm	H cm	Lts	
P218016	16	16,0	3,0	1
P218018	18	18,0	4,5	1
P218020	20	20,0	6,2	1
P218024	24	24,0	10,0	1
P218028	28	28,0	16,5	1
P218030	30	30,0	21,2	1
P218032	32	32,0	24,0	1
P218035	35	35,0	33,6	1
P218040	40	40,0	50,0	1
P218045	45	45,0	72,0	1
P218050	50	50,0	98,0	1
P218060	60	55,0	155,0	1

**P217** Casserole without lid  
*Cacerola baja sin tapa*  
Faitout sans couvercle



REF	Ø cm	H cm	Lts	
P217016	16	7,5	1,5	1
P217018	18	8,0	2,0	1
P217020	20	8,0	2,5	1
P217024	24	9,50	4,3	1
P217028	28	11,0	6,7	1
P217030	30	12,0	8,4	1
P217032	32	12,5	10,0	1
P217035	35	14,0	13,6	1
P217040	40	15,5	19,5	1
P217045	45	17,0	27,0	1
P217050	50	20,0	39,0	1
P217060	60	23,0	65,0	1

**P216** Sauce pot without lid  
*Cacerola alta sin tapa*  
Braisière sans couvercle



REF	Ø cm	H cm	Lts	
P216016	16	11,0	2,1	1
P216018	18	12,0	3,0	1
P216020	20	13,0	4,0	1
P216024	24	14,0	6,3	1
P216028	28	17,5	10,2	1
P216030	30	18,0	12,7	1
P216032	32	19,0	15,2	1
P216035	35	21,0	20,2	1
P216040	40	25,0	31,4	1
P216045	45	28,0	44,5	1
P216050	50	30,0	59,0	1
P216060	60	35,0	99,0	1

**P205** Paella pan without lid  
*Paellera sin tapa*  
Plat à paella sans couvercle



REF	Ø cm	H cm	Lts	
P205020	20	6,0	1,9	1
P205024	24	6,0	2,7	1
P205028	28	6,0	3,7	1
P205030	30	6,0	4,3	1
P205032	32	6,0	4,7	1
P205035	35	7,0	6,7	1
P205040	40	8,0	10,0	1
P205045	45	8,5	12,0	1
P205050	50	9,0	17,5	1
P205060	60	10,0	28,0	1

## Inox-Pro 2.2



**P209** Lid  
*Tapa*  
Couvercle



REF	Ø cm	
P209016	16	1
P209018	18	1
P209020	20	1
P209024	24	1
P209028	28	1
P209030	30	1
P209032	32	1
P209035	35	1
P209040	40	1
P209045	45	1
P209050	50	1
P209060	60	1

**P202** Deep saucepan  
*Cazo recto alto*  
Casserole haute



REF	Ø cm	H cm	Lts	
P202016	16	11,0	2,1	1
P202018	18	12,0	3,0	1
P202020	20	13,0	4,0	1
P202024	24	14,0	6,3	1
P202028	28	17,5	10,2	1
P202032	32*	19,0	15,2	1

\* With counterhandle / Con contraasa / Avec contre anse

**P2001** Saucepan with side spouts  
*Cazo con picos laterales*  
Casserole avec becs verseurs



REF	Ø cm	H cm	Lts	
P200116	16	7,5	1,5	1
P200120	20	10,0	3,1	1

**P201** Saucepan  
*Cazo recto bajo*  
Casserole



Ref	Ø cm	H cm	Lts	
P201016	16	7,5	1,5	1
P201018	18	8,0	2,0	1
P201020	20	8,0	2,5	1
P201024	24	9,5	4,3	1
P201028	28	11,0	6,7	1
P201032	32*	12,50	10,0	1

\* With counterhandle / Con contraasa / Avec contre anse

**P200** French style saucepan  
*Cazo tipo francés*  
Casserole forme française



REF	Ø cm	H cm	Lts	
P200012	12	7,0	0,7	1
P200014	14	7,0	1,0	1
P200016	16	7,5	1,5	1
P200018	18	9,0	2,3	1
P200020	20	10,0	3,1	1
P200022	22	11,0	4,2	1
P200024	24	12,0	5,4	1
P200028	28	14,0	8,6	1

**P214** Conical sauté pan  
*Cazo cónico*  
Sauteuse evasée



REF	Ø cm	H cm	Lts	
P214016	16	6,0	1,0	1
P214018	18	6,0	1,2	1
P214020	20	6,5	1,6	1
P214022	22	7,0	2,1	1
P214024	24	7,5	2,7	1

## 2.2 Inox-Pro



**P2003** Rounded saucepan  
Cazo bombeado  
Casserole bombée



With diffusing bottom sandwich type  
Con fondo termodifusor tipo sandwich  
Avec fond thermo diffuseur type sandwich

REF	Ø cm	H cm	Lts	
P200320	20	7,5	1,8	1
P200324	24	8,5	3,0	1

**P203** Bain marie  
Baño maría  
Bain-marie



With diffusing bottom sandwich type  
Con fondo termodifusor tipo sandwich  
Avec fond thermo diffuseur type sandwich

REF	Ø cm	H cm	Lts	
P203016	16	16,0	3,0	1
P203018	18	18,0	4,5	1
P203020	20	20,0	6,2	1
P203024	24	24,0	10,0	1

**P204** Sauté pan  
Sautex  
Sauteuse



REF	Ø cm	H cm	Lts	
P204020	20	6,0	1,9	1
P204024	24	6,0	2,7	1
P204028	28	6,0	3,7	1
P204030	30	6,0	4,3	1
P204032	32	6,0	4,7	1
P204035	35	7,0	6,7	1
P204040*	40	8,0	10,0	1

\* With counterhandle / Con contraasa / Avec contre anse

## Multimetal

St/Steel - Inox

Tri-aluminium

St/Steel - Inox

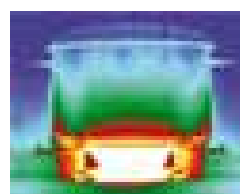
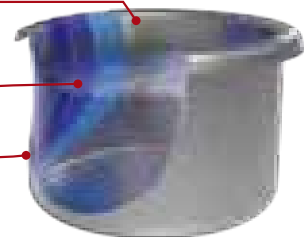

st/steel - Inox

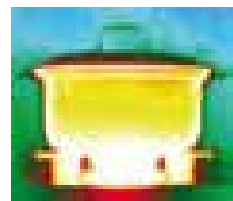

Multimetal

**P234** Rounded saucepan  
Cazo bombeado  
Casserole bombée



REF	Ø cm	H cm	Lts	
P234020	20	7,5	1,8	1
P234024	24	8,5	3,0	1

## Inox-Pro 2.2



**P240** Conical couscous set with lid  
Conjunto cuscusera bombeada, con tapa  
Couscoussier bombée avec couvercle



REF	Ø cm	H cm	Lts		
P240040	A	40	20,0	20,0	1
	B	32	32,0	24,0	
P240050	A	50	25,0	40,0	1
	B	40	40,0	50,0	

**P242** Straight couscous set  
Conjunto cuscusera forma recta  
Couscoussier forme droite



REF	Ø cm	H cm	Lts		
P242024	A	24	14,0	6,3	1
	B	24	24,0	10,0	
P242028	A	28	17,5	10,0	1
	B	28	28,0	16,5	
P242032	A	32	19,0	15,0	1
	B	32	32,0	24,0	
P242035	A	35	21,0	20,0	1
	B	35	35,0	33,6	

With lid / Con tapa / Avec couvercle

**P241** Top for couscous set conical shape  
Parte superior de cuscusera bombeada  
Dessus seul pour couscoussier forme bombée



REF	Ø cm	H cm	Lts	
P241040	40	20,0	20,0	1
P241050	50	25,0	40,0	1

Ø holes / agujeros / trous 4 mm  
Without lid / Sin tapa / Sans couvercle

**P243** Top for steam pot and couscous set straight shape  
Parte superior de vaporera y cuscusera  
Dessus seul pour couscoussier forme droite et cuit vapeur



Ref	Ø cm	H cm	Lts	
P243024	24	14,0	6,3	1
P243028	28	17,5	10,0	1
P243032	32	19,0	15,0	1
P243035	35	21,0	20,0	1

Ø holes / agujeros / trous 4 mm  
Without lid / Sin tapa / Sans couvercle

## 2.2 Inox-Pro

CLASS  
INDUCTION

SS  
Stainless  
steel

**P244** Steam pot  
Conjunto vaporera  
Cuit vapeur



REF		Ø cm	H cm	Lts	
P244020	A	20	13,0	4,0	1
	B	20	13,0	4,0	
P244024	A	24	14,0	6,3	1
	B	24	14,0	6,3	
P244028	A	28	17,5	10,0	1
	B	28	17,5	10,0	
P244032	A	32	19,0	15,0	1
	B	32	19,0	15,0	
P244035	A	35	21,0	20,0	1
	B	35	21,0	20,0	

With lid / Con tapa / Avec couvercle

**P223** Casserole set + 4 pasta colander  
Conjunto cacerola + 4 colapastas  
Ensemble braisière + 4 cuit-pâtes



REF		Ø cm	H cm	Lts	
P223035		35	21,0	20,2	1
P223040		40	25,0	31,4	1

**Casserole data 216.**  
Datos relativos a la cacerola 216.  
Caractéristiques afférentes au braisière 216.

Without lid / Sin tapa / Sans couvercle

**P224** Pasta colander  
Colapasta  
Cuit-pâtes



REF		H cm	
P224023	A	23,0	12
P224026	B	26,0	6

**A It fits ref. 216 - Ø 35 cm**  
A Utilizable para la ref. 216 - Ø 35 cm  
A Utilisable pour la ref. 216 - Ø 35 cm

**B It fits ref. 216 - Ø 40 cm**  
B Utilizable para la ref. 216 - Ø 40 cm  
B Utilisable pour la ref. 216 - Ø 40 cm

**P248** Stock pot with tap and lid  
Olla con grifo y tapa  
Marmite traiteur avec robinet et couvercle



REF		Ø cm	H cm	Lts	
P248028		28	28,0	16,5	1
P248032		32	32,0	24,0	1
P248035		35	35,0	33,6	1
P248040		40	40,0	50,0	1
P248045		45	45,0	72,0	1



# 2.3 COOL-LINE

EXCLUSIVE

**Cookware body made of 18/10 stainless steel**  
Cuerpo en acero inoxidable 18/10  
Corps en acier inoxydable 18/10



**Special lid designed to hold on the side handle**  
Tapa con diseño especial para apoyo en asa lateral  
Couvercle spécial, conçu pour reposer sur la poignée

**Ergonomic handles made of cast st/steel**  
Asas ergonómicas fabricadas en acero inoxidable de fundición  
Anses en fonte d'acier inoxydable, ergonomiques

**Tech sandwich base**  
Fondo termo difusor técnico  
Fond thermo-diffuseur technique



## Cool-line 2.3



**Ref. colour**  
Ref. color  
Ref. couleur couvercle

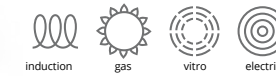

**P4906CO** Sauce pot with lid  
Cacerola alta con tapa  
Braisinge avec couvercle



REF	Ø cm	H cm	Lts	📦
P490620 + COLOR	20	13,0	3,7	1
P490624 + COLOR	24	14,0	5,8	1
P490628 + COLOR	28	17,5	9,5	1
P490632 + COLOR	32	19,0	14,0	1

**P4907CO** Casserole with lid  
Cacerola baja con tapa  
Faitout avec couvercle



REF	Ø cm	H cm	Lts	📦
P490724 + COLOR	24	9,5	3,9	1
P490728 + COLOR	28	11,0	5,8	1
P490732 + COLOR	32	12,5	8,9	1

**P4909** Paella pan with lid  
Paellera con tapa  
Plat à paella avec couvercle



REF	Ø cm	H cm	Lts	📦
P490928 + COLOR	28	6,0	3,7	1
P490932 + COLOR	32	6,0	4,7	1

**P4900CO** Saucepan  
Cazo recto  
Casserole



REF	Ø cm	H cm	Lts	📦
P490014 + COLOR	14	7,0	1,0	1
P490016 + COLOR	16	7,5	1,5	1

# 2.4 CENTURY

**Pure extra strength aluminium cookware**  
*Batería de aluminio puro extra fuerte*  
 Batterie de cuisine en aluminium pur extra fort



Made of 100% recyclable pure aluminum sheets of up to 5 mm (depending on diameter).

*Fabricadas en chapas de aluminio de hasta 5 mm (según diámetro) de puro aluminio 100% reciclable.*

Faites de tôles d'aluminium à 100 % recyclable, jusqu'à 5 mm d'épaisseur (selon le diamètre).

**Reinforced rims**  
*Bordes reforzados*  
 Bords renforcés

**Ergonomic handles**  
*Asas ergonómicas*  
 Anses ergonomiques

**Highly resistant and safe riveting**  
*Remache de alta resistencia y seguridad*  
 Rivet à haute résistance et sécurité

**Extra-thick walls**  
*Paredes de mayor grosor*  
 Parois plus épaisses

**Polished exterior preventing the growth of bacteria**  
*Exterior pulido evita alojamiento de bacterias*  
 L'extérieur poli prévient l'accumulation de bactéries

Cookware is sold without lids.  
*Las baterías de cocina se venden sin tapa.*  
 Les batteries de cuisine sont-elles vendues sans couvercle.



**Homogeneous cooking**  
*Cocción homogénea*  
 Cuisson homogène

**Excellent thermal conductivity**  
*Excelente conductividad térmica*  
 Excellente conductivité thermique

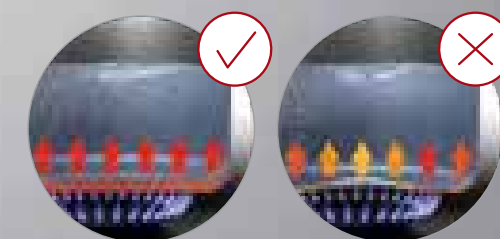

**Base thickness that prevents deformation, in full contact with the heat source, thus improving energy efficiency.**

*Espesor del fondo que evita la deformación, en contacto total con la fuente de calor que permite un mayor rendimiento energético.*

L'épaisseur du fond évite sa déformation, il est intégralement en contact avec la source de chaleur, ce qui permet un meilleur rendement énergétique.

## 2.4 Century

AI  
Aluminium

**P1183** Stock pot without lid  
*Olla sin tapa*  
Marmite traiteur sans couvercle

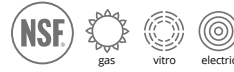

REF	Ø cm	H cm	Lts	
P118324	24	24,0	10,0	1
P118328	28	28,0	16,5	1
P118332	32	32,0	25,5	1
P118335	35	35,0	33,6	1
P118340	40	40,0	50,0	1
P118345	45	45,0	72,0	1
P118350	50	50,0	98,0	1
P118360	60	60,0	155,0	1

**P1173** Casserole without lid  
*Cacerola baja sin tapa*  
Faitout sans couvercle

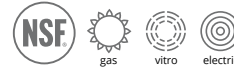

REF	Ø cm	H cm	Lts	
P117324	24	9,5	4,3	1
P117328	28	11,0	6,7	1
P117332	32	12,5	10,0	1
P117335	35	14,0	13,0	1
P117340	40	16,0	20,0	1
P117345	45	18,0	28,0	1
P117350	50	21,0	41,0	1
P117360	60	25,0	70,0	1

**P1163** Sauce pot without lid  
*Cacerola alta sin tapa*  
Braising pot sans couvercle

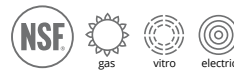

REF	Ø cm	H cm	Lts	
P116324	24	14,0	6,3	1
P116328	28	17,5	10,2	1
P116332	32	19,0	15,2	1
P116335	35	21,0	20,2	1
P116340	40	25,0	31,4	1
P116345	45	28,0	44,5	1
P116350	50	31,0	60,8	1
P116360	60	37,0	104,6	1

**P1153** Paella pan without lid  
*Paellera sin tapa*  
Plat à paella sans couvercle

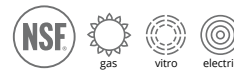

REF	Ø cm	H cm	Lts	
P115320	20	5,5	1,75	1
P115324	24	6,0	2,75	1
P115340	40	8,0	10,00	1

## Century 2.4

AI  
Aluminium

**P1123** Lid  
*Tapa*  
Couvercle



REF	Ø cm	
P112324	24	1
P112328	28	1
P112332	32	1
P112335	35	1
P112340	40	1
P112345	45	1
P112350	50	1
P112360	60	1

**P1043** Saucepan  
*Cazo recto*  
Casserole

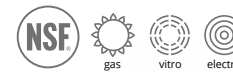

REF	Ø cm	H cm	Lts	
P104318	18	9	2	1
P104320	20	10	3	1
P104324	24	12	5	1

**P1063** Sauté pan  
*Sautex*  
Sauteuse

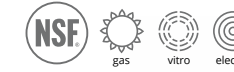

REF	Ø cm	H cm	Lts	
P106320	20	5,5	1,75	1
P106324	24	6,0	2,75	1

**P1033** Rounded saucepan  
*Cazo bombeado*  
Casserole bombée

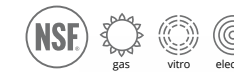

REF	Ø cm	H cm	Lts	
P103322	22	11	3	1

See products on  
Ver productos en / Voir produits en page

P. 74

**Aluminium non-stick fry pan**  
*Sartén aluminio antiatherente*  
Poêle anti-adhésive



# 2.5 BLACK SERIES



Manufactured from cast aluminium offering high deformation resistance and excellent thermal properties

Fabricada en aluminio de fundición de gran resistencia a la deformación y con excelentes prestaciones térmicas

Fabriqué en fonte d'aluminium très résistante à la déformation et dotée d'excellentes performances techniques

Exterior: black, high temperature resistant paint

Exterior: pintura negra resistente a altas temperaturas

Extérieur : peinture noire résistante aux températures élevées

Highly resistant non-stick surface

Antiadherente de alta resistencia

Antiadhésif très résistant



## P141 Shallow casserole without lid

Cazuela baja sin tapa  
Cocotte sans couvercle



Ground base  
Fondo torneado  
Fond dressé

REF	Ø cm	H cm	Lts	☐
P141014*	14	4,0	0,55	1
P141016*	16	5,0	0,90	1
P141020*	20	5,5	1,50	20
P141024	24	5,8	2,25	10
P141028	28	7,5	4,00	1
P141032	32	8,0	5,75	1
P141036	36	8,5	7,75	5
P141040	40	10,0	11,25	4

## P161 Paella pan without lid

Paella sin tapa  
Plat à paella sans couvercle



REF	Ø cm	H cm	☐
P161034	34	4	1
P161038	38	4	1



Ideal for ovens, grills and barbecues  
Ideal para hornos, brasa y barbacoa  
Idéal pour fours, grill et barbecue

## P151 Deep casserole without lid

Cazuela alta sin tapa  
Braisière sans couvercle



Ground base  
Fondo torneado  
Fond dressé

REF	Ø cm	H cm	Lts	☐
P151012*	12	8,5	0,85	12
P151014*	14	8,5	1,10	1
P151016*	16	8,0	1,40	12
P151020	20	9,0	2,50	12
P151024	24	10,0	4,00	6
P151028	28	12,0	6,65	6
P151032	32	14,0	10,00	3

See products on

Ver productos en / Voir produits en page

P. 399



\*MINI-SIZE

Ideal for food presentation.  
Ideal para presentación.  
Idéal pour présentation.

# 2.6 BLACK FORGED



Forged aluminium with a non-stick interior surface and with high temperature resistant paint on the outside

Aluminio forjado con antiadherente en su interior, y pintura resistente a altas temperaturas en el exterior

Aluminium avec revêtement antiadhésif à l'intérieur, et peinture résistante aux températures élevées à l'extérieur

Full heat-diffusing base which offers excellent performance on induction hobs.

Fondo difusor completo que permite un excelente rendimiento en cocinas de inducción.

Fond diffuseur complet offrant une haute performance sur les cuisinières a induction.

Ferritic stainless steel sheet that covers the whole of the base.

Chapa de acero inoxidable ferrítico que cubre la totalidad del fondo.

Plaque en acier inoxydable ferritique qui couvre tout le fond.

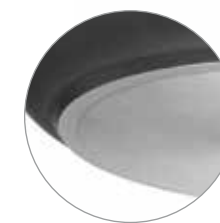

Glass lid  
Tapa de cristal  
Couvercle en verre

## P170 Saucepot with lid

Cacerola alta con tapa  
Braisière avec couvercle

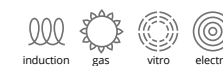

Silicone handles included  
Asas de silicona incluidas  
Anses en silicone incluses



REF	Ø cm	H cm	Lts	☐
P170020	20	8,5	2,5	2
P170024	24	9,0	4,0	2
P170028	28	12,5	7,5	2

## P171 Casserole with lid

Cacerola baja con tapa  
Faitout avec couvercle

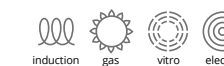

Silicone handles included  
Asas de silicona incluidas  
Anses en silicone incluses



REF	Ø cm	H cm	Lts	☐
P171024	24	7,5	3,0	2
P171028	28	7,5	4,5	2

## P173 Saucepan

Cazo  
Casserole

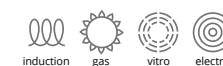

REF	Ø cm	H cm	Lts	☐
P173016	16	8,4	1,5	2

See products on

Ver productos en / Voir produits en page

P. 80



Black forged fry pan  
Sartén black forged  
Poêle black forged











Bakelite handle / Mango baquelita / Queue en bakélite



# 3 Fry pans

Sartenes  
Poêles



<b>3.1</b>		<b>WEAR EVER</b> 	68
<b>3.2</b>		<b>TRIBUTE</b> 	69
<b>3.3</b>		<b>ST/STEEL</b> <i>ACERO INOXIDABLE / ACIER INOXYDABLE</i>	70
		<b>INOX PRO</b>	70
		<b>IDEA</b>	72
<b>3.4</b>		<b>ALUMINIUM</b> <i>ALUMINIO / ALUMINIUM</i>	73
		<b>ALU PRO INDUCTION</b>	73
		<b>ALU PRO NO INDUCTION</b>	74
<b>3.5</b>		<b>MULTI-PLY</b> <i>MULTIMETAL / MULTI-METAL</i>	77
<b>3.6</b>		<b>CAST ALUMINIUM</b> <i>ALUMINIO FUNDICIÓN / FONTE D'ALUMINIUM</i>	76
		<b>BLACK PRO</b>	78
		<b>BLACK FORGED</b>	80
		<b>BLACK FIRST</b>	80
<b>3.7</b>		<b>STEEL</b> <i>ACERO / ACIER</i>	81
		<b>STEEL PRO</b>	81
		<b>STEEL CLASSIC</b>	82
<b>3.8</b>		<b>SPANISH PAELLA PAN</b> <i>PAELLERA / PLAT À PAELLA</i>	84

# Which material should I choose?

¿Qué material debo elegir?  
Quel matériau choisir ?

	<b>STAINLESS STEEL</b>	<b>ALUMINIUM</b>	<b>CAST ALUMINIUM</b>	<b>MULTI-PLY</b>	<b>CARBON STEEL</b>
	ACERO INOX ACIER INOX	ALUMINIO ALUMINIUM	ALUMINIO FUNDICION ALUMINIUM DE FONTE	MULTIMETAL MULTIMÉTAL	ACERO AL CARBONO ACIER AU CARBONE
	<b>SS</b> Stainless steel	<b>Al</b> Aluminium	<b>CA</b> Cast Aluminium	<b>Mp</b> Multiply	<b>CS</b> Carbon steel
<b>MATERIAL MATERIAL MATÉRIAU</b>	<b>High resistance to impact, maintaining a perfect physical state.</b> <i>Alta resistencia a impactos, manteniendo un perfecto estado físico.</i> Haute résistance aux chocs, conserve un aspect physique parfait.	<b>Extremely light and very malleable. Little resistance to impacts.</b> <i>Extremadamente ligero y muy maleable. Poco resistente a los golpes.</i> Extrêmement léger et très malléable. Peu résistant aux coups.	<b>High resistance to deformation. Temperatures up to 160°C.</b> <i>Gran resistencia a la deformación. Temperaturas hasta 160°C.</i> Haute résistance à la déformation. Températures jusqu'à 160°C.	<b>Solid and impact resistant.</b> <i>Sólido y resistente a impactos.</i> Solide et résistant aux impacts.	<b>Very high weight. Highly vulnerable to corrosion (oxidization)</b> <i>Peso muy elevado. Altamente vulnerable a la corrosión (oxidación).</i> Poids très élevé. Haute vulnérabilité à la corrosion (oxydation).
<b>THERMAL CONDUCTIVITY CONDUCTIVIDAD TÉRMICA CONDUCTIVITÉ THERMIQUE</b>	<b>Perfect sealing of the thermodiffusing base. Efficient heat distribution.</b> <i>Perfecta fijación del fondo difusor. Eficiente distribución del calor.</i> Parfaite fond thermodiffuseur. Distribution efficace de la chaleur.	<b>Good conductivity and uniform heat distribution. Optimum material for energy saving.</b> <i>Buena conductividad y distribución uniforme del calor. Óptimo material para ahorro de energía.</i> Bonne conductivité et distribution très uniforme. Matériau optimal pour l'économie d'énergie.	<b>Excellent energy efficiency thanks to its induction base.</b> <i>Excelente eficiencia energética gracias a la base de inducción que posee.</i> Efficacité énergétique excellente grâce à sa base à induction.	<b>High thermal conductivity thanks to its inner layer of aluminium.</b> <i>Conductividad térmica alta gracias a la capa interior de aluminio que posee.</i> Haute conductivité thermique grâce à la couche intérieure d'aluminium.	<b>Very stable temperature for long cooking times.</b> <i>Temperatura muy estable para cocinados de larga duración.</i> Haute conductivité thermique grâce à la couche intérieure d'aluminium.
<b>USE USO UTILISER</b>					
<b>MAINTENANCE AND HYGIENE MANTENIMIENTO E HIGIENE ENTRETIEN ET HYGIÈNE</b>	<b>Non porous-material. Easy to clean. Not adherence for food residues.</b> <i>Material no poroso. Fácil de limpiar. No adherencia de resto de alimentos.</i> Matériau non poreux. Facile à nettoyer. Difficile attacher du restes d'aliments.	<b>Porous material. Very important to clean it properly to avoid contaminate food.</b> <i>Material poroso. Limpieza correcta para evitar posible adherencia de bacterias.</i> Matériau poreux. Nettoyage correct pour éviter une éventuelle adhérence de bactéries.	<b>Wash with hot water, neutral soap and non-abrasive sponge. Rinse plenty of water.</b> <i>Lavar con agua caliente, jabón neutro y esponja no abrasiva. Enjuagar con abundante agua.</i> Laver avec de l'eau chaude, du savon neutre et une éponge non abrasive. Rincer abondamment à l'eau.	<b>Cover with professional higienic material (stainless steel). Dishwasher is not recommended.</b> <i>Recubrimiento de material higiénico profesional (acero inoxidable). No se recomienda el uso de lavavajillas.</i> Revêtement en matériau hygiénique professionnel (acier inoxydable). L'utilisation du lave-vaisselle est déconseillée.	<b>Before first use, it is advisable to use it to cook a disposable product. This allows the initial impurities to be cleaned from the pan.</b> <i>Antes del primer uso, se aconseja cocinar algún producto desechable. Esto permitirá limpiar las impurezas iniciales del recipiente.</i> Avant la première utilisation, il est conseillé de faire cuire un produit jetable. Ce qui permettra de nettoyer les impuretés du récipient.

# Handles

Mangos  
Manches

## ERGOS

**MORE ERGONOMIC**  
MAYOR ERGONOMÍA  
PLUS ERGONOMIQUE

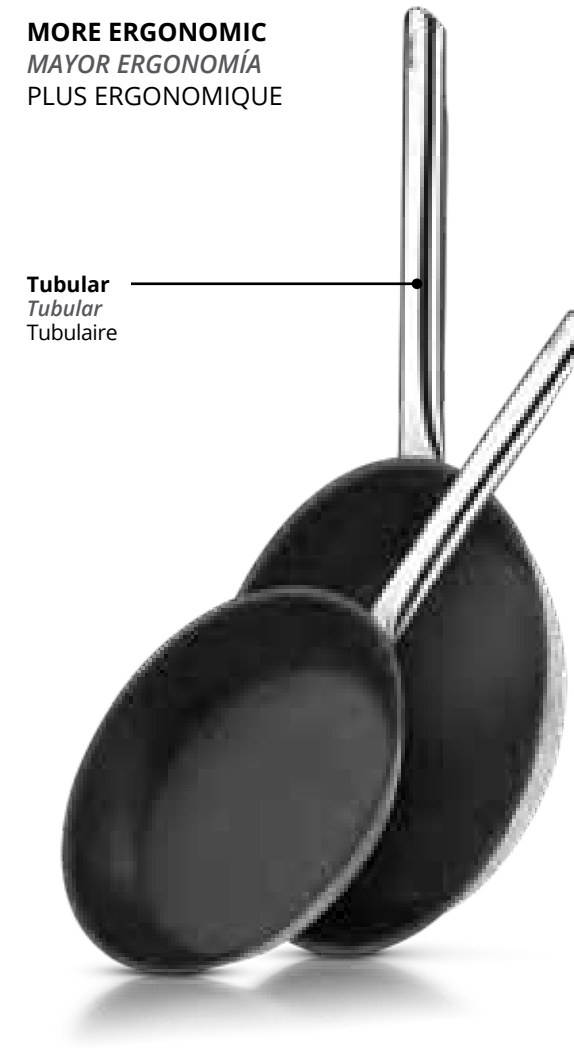

**Tubular**  
Tubular  
Tubulaire

**Pujadas ERGOS handles are characterized by being made from stainless steel tubing. Thanks to a flattening process, the tubing becomes an ergonomic and heat insulating handle.**

**These handles are made with two holes at the two innermost end, to ensure that no water from the washing process remains inside and comes out in the form of steam when the pan is heated.**

*Los mangos ERGOS de Pujadas se caracterizan por estar fabricados en tubo de acero inoxidable. Gracias a un proceso de allanado, lo convierte en un mango ergonómico y aislante del calor. Estos mangos se presentan con dos agujeros en los dos extremos interiores, para asegurar que ninguna gota de agua quede dentro en el proceso de lavado y ésta salga en forma de vapor durante el calentamiento de la sartén.*

**Les manches ERGOS de Pujadas se caractérisent par leur fabrication à partir d'un tube en acier inoxydable. Le processus d'aplanissement obtient un manche ergonomique doté d'une isolation thermique.**

**Ces manches sont présentés avec deux trous aux deux extrémités intérieures, pour qu'aucune goutte d'eau ne reste à l'intérieur pendant le processus de lavage et que celle-ci sorte sous forme de vapeur lors du chauffage de la poêle.**

## HÉRCULES

**GREATER STRENGTH**  
MAYOR SUJECIÓN  
MEILLEURE PRISE

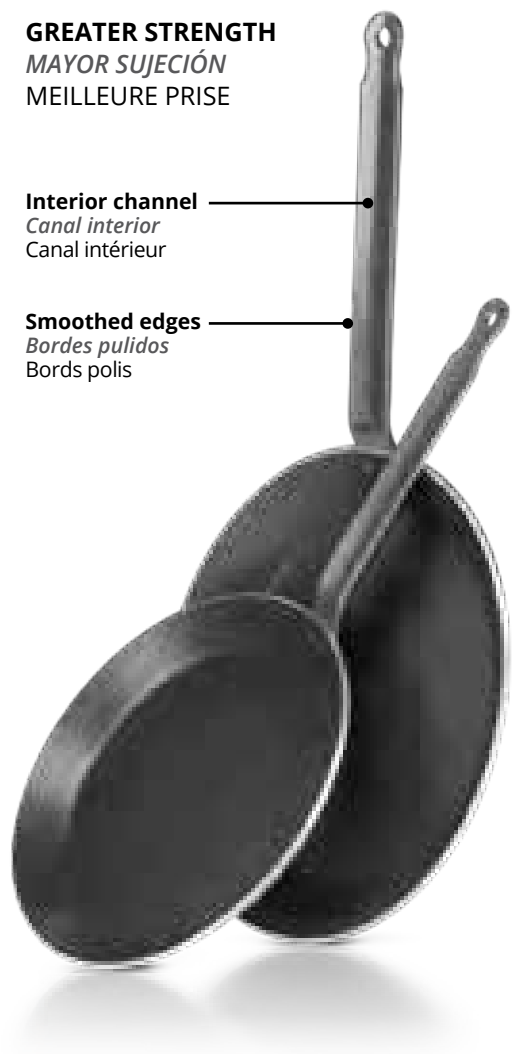

**Interior channel**  
Canal interior  
Canal intérieur

**Smoothed edges**  
Bordes pulidos  
Bords polis

**HÉRCULES handles are made of flat iron sheet coated with a high temperature resistant protective paint, which prevents rapid oxidation.**

**The handles have smoothed edges and a slight channel in the centre for increased strength.**

*Los mangos HÉRCULES son aquellos fabricados en chapa plana de hierro recubiertos con una pintura protectora resistente a altas temperaturas, que evita una rápida oxidación.*

*Esta chapa se presenta con los bordes pulidos y con una ligera canal en medio para una mejor sujeción.*

**Les manches HÉRCULES sont fabriqués en plaque de fer plate et recouverts d'une peinture protectrice résistante aux températures élevées, qui évite une oxydation rapide.**

**Cette plaque est dotée de bords polis et d'un léger canal au milieu pour une meilleure prise.**

# Which fry pan do you need?

¿Qué paella necesitas?  
Quelle poêle vous faut-il ?

FRY PANS  
SARTENS  
POÊLES

FRY PANS  
SARTENS  
POÊLES































## Stainless Steel Acero Inoxidable Acier Inox

























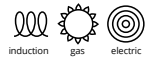
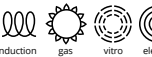
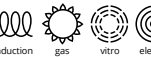
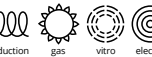

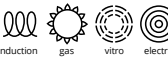
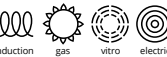



## Aluminium Aluminio Aluminium

## Multi-ply Multimetal Multi-metal

## Cast aluminium Aluminio fundición Fonte d'aluminium

## Steel Acero Acier

	<b>INOX PRO</b>  P. 70 <b>BEST SELLER</b>	<b>INOX CERAMIC</b>  P. 71	<b>IDEA</b>  P. 72	<b>WEAR EVER</b>  P. 68 <b>NEW!</b>	<b>ALU PRO INDUCT.</b>  P. 73	<b>ALU PRO</b>  P. 74
<b>COMPATIBLE WITH</b> COMPATIBLE CON COMPATIBLE AVEC	 <b>INDUCTION</b>	 <b>INDUCTION</b>	 <b>INDUCTION</b>	 <b>NO INDUCTION</b>	 <b>INDUCTION</b>	 <b>NO INDUCTION</b>
						
<b>PRICE</b> PRECIO PRIX						
<b>THICKNESS</b> ESPESOR EPAISSEUR	0,8 mm	0,8 mm	0,7 mm	4 mm	4 mm	4 mm
<b>COATING</b> ANTIADHERENTE REVÊTEMENT				<b>STEELCOAT X 3®</b> 	 	
<b>HANDLE</b> MANGO QUEUE	<b>ST/STEEL</b> INOXIDABLE INOXYDABLE	<b>ST/STEEL</b> INOXIDABLE INOXYDABLE	<b>ST/STEEL</b> INOXIDABLE INOXYDABLE	<b>ST/STEEL</b> INOXIDABLE INOXYDABLE	<b>ST/STEEL</b> INOXIDABLE INOXYDABLE	<b>ST/STEEL</b> INOXIDABLE INOXYDABLE
<b>RECOMMENDED</b> RECOMENDADA RECOMMANDÉE	<b>HIGH RESISTANCE TO ABRASION</b> ALTA RESISTENCIA A LA ABRASIÓN HAUTE RÉSISTANCE À L'ABRASION	<b>HIGH RESISTANCE TO ABRASION</b> ALTA RESISTENCIA A LA ABRASIÓN HAUTE RÉSISTANCE À L'ABRASION	<b>PROFESSIONAL STRENGTH</b> RESISTENCIA PROFESIONAL DURETÉ PROFESSIONNEL	<b>PROFESSIONAL STRENGTH</b> RESISTENCIA PROFESIONAL DURETÉ PROFESSIONNEL	<b>HIGH RESISTANCE TO ABRASION</b> ALTA RESISTENCIA A LA ABRASIÓN HAUTE RÉSISTANCE À L'ABRASION	<b>SLOW BAKING</b> COCCIÓN A FUEGO LENTO CUISSON À FEU LENT

	<b>TRIBUTE</b>  P. 69 <b>NEW!</b>	<b>MULTI-PLY</b>  P. 77	<b>BLACK PRO</b>  P. 78	<b>BLACK FORGED</b>  P. 80	<b>BLACK FIRST</b>  P. 80	<b>STEEL PRO</b>  P. 81	<b>STEEL CLASSIC</b>  P. 83
<b>COMPATIBLE WITH</b> COMPATIBLE CON COMPATIBLE AVEC	 <b>INDUCTION</b>	 <b>INDUCTION</b>	 <b>INDUCTION</b>	 <b>INDUCTION</b>	 <b>NO INDUCTION</b>	 <b>INDUCTION</b>	 <b>INDUCTION</b>
							
<b>PRICE</b> PRECIO PRIX							
<b>THICKNESS</b> ESPESOR EPAISSEUR	4 mm	3,5 mm	4 mm	3 mm	4 mm	2 mm	1,5 mm
<b>COATING</b> ANTIADHERENTE REVÊTEMENT	<b>CERAMIGUARD® II</b> 						<b>NINGUNO</b> NONE AUCUN
<b>HANDLE</b> MANGO QUEUE	<b>ST/STEEL</b> INOXIDABLE INOXYDABLE	<b>ST/STEEL</b> INOXIDABLE INOXYDABLE	<b>ST/STEEL</b> INOXIDABLE INOXYDABLE	<b>BAKELITE</b> BAQUELITA BAKELIT (MAX. TEMP. 160 °C)	<b>WOODEN</b> MADERA BOIS	<b>ST/STEEL</b> INOXIDABLE INOXYDABLE	<b>FLAT IRON</b> HIERRO FER
<b>RECOMMENDED</b> RECOMENDADA RECOMMANDÉE	<b>HEAT DISTRIBUTION SATIN FINISH</b> DISTRIBUCIÓN CALOR ACABADO SATINADO RÉPARTITION CHALEUR FINITION SATINÉE	<b>HOMOGENEITY AND THERMAL EFFECTIVENESS</b> HOMOGENEIDAD Y EFICACIA TÉRMICA HOMOGÉNÉITÉ ET EFFICACITÉ THERMIQUE	<b>ROBUSTNESS AND GOOD SLIDING</b> ROBUSTEZ Y BUEN DESLIZAMIENTO ROBUSTESSE ET BON GLISSEMENT	<b>ROBUSTNESS AND EFFICIENCY</b> ROBUSTEZ Y EFICIENCIA ROBUSTESSE ET EFFICACITÉ	<b>ROBUSTNESS AND GOOD SLIDING</b> ROBUSTEZ Y BUEN DESLIZAMIENTO ROBUSTESSE ET BONGLISSEMENT	<b>HIGH TEMPERATURES</b> ALTAS TEMPERATURAS HAUTES TEMPERATURES	<b>SEALING, FRYING, BROWNING</b> SELLAR, FREIR, DORAR CULOTTAGE, FRIRE ET DORER

# 3.1 WEAR EVER



The Vollrath® Wear-Ever frying pan combines outstanding durability with dependable performance. Its impact-resistant aluminium construction heats and cools quickly, with a low-profile design that cleans just as easily. Our advanced SteelCoat x3® takes non-stick to the next level, providing better release, faster cleaning and longer life. The new handle provides a cooler, more comfortable ergonomic grip.

La sartén Wear-Ever de Vollrath® combina una durabilidad excepcional con una fiabilidad única. Fabricada en aluminio resistente a los impactos, se calienta y enfría rápidamente y su diseño extra plano se limpia fácilmente. Nuestro avanzado recubrimiento SteelCoat x3® eleva el antiadherente al siguiente nivel ofreciendo una mayor capacidad para resbalar a los alimentos, una limpieza más rápida y una vida útil superior. El nuevo mango, de tacto frío, ofrece un agarre ergonómico más confortable.

La poêle Vollrath® Wear-Ever combine durabilité exceptionnelle et performances fiables. Fabriquée en aluminium résistant aux chocs, elle chauffe et refroidit rapidement, sa conception extraplate se nettoie tout aussi facilement. Notre revêtement SteelCoat x3® avancé fait passer l'antiadhésif au niveau supérieur, offrant un meilleur démoulage, un nettoyage plus rapide et une durée de vie plus longue. Le nouveau manche offre un toucher froid et une prise ergonomique plus confortable.



## 6713 Non-stick fry pan Sartén antiadherente Poêle anti-adhésive

REF	Ø cm	H cm	☐
671307	18	4	1
671308	20	4	1
671310	24	5	1
671312	28	5	1
671314	32	6	1

Also available with silicone handle.  
También disponible con mango silicona.  
Également disponible avec poignée en silicone.



Professional ergonomic handle resistant to high temperatures. Patented by Vollrath.

Mango ergonómico profesional resistente a altas temperaturas. Patentado por Vollrath.

Manche ergonomique professionnel résistant aux températures élevées. Breveté par Vollrath.

High-quality non-stick coating for longer life.

Antiadherente de gran calidad para una mayor vida útil.

Antiadhésif de haute qualité pour une durée de vie plus longue.

Heavy-duty, impact-resistant aluminum construction.

Fabricada con cuerpo de aluminio de alta calidad, resistente a impactos, para uso intensivo.

Fabriqué avec un corps en aluminium de haute qualité et résistant aux chocs pour une utilisation intensive.

# TRIBUTE 3.2



A versatile choice for high-end commercial kitchens, the extremely durable Tribute® frying pan's 3-ply construction delivers perfect heat distribution for impressive results. Frying, sautéing or searing, this induction-ready pan with premium CeramiGuard® II nonstick coating delivers exceptionally smooth release and easy cleaning. The new handle provides a cooler, more comfortable ergonomic grip, while the Ever-Tite system promises a limited lifetime warranty against loose rivets.

Una elección versátil de alta gama para las cocinas profesionales, la concepción tri-capa extremadamente duradera de la sartén Tribute® ofrece una distribución perfecta del calor para resultados impresionantes. Freír, saltar o sellar, esta sartén para inducción con recubrimiento antiadherente de alta gama CeramiGuard® II ofrece una liberación de los alimentos excepcionalmente suave y una limpieza fácil. El nuevo mango, de tacto frío, ofrece un agarre ergonómico más confortable mientras que el sistema Ever-Tite promete toda una vida de garantía contra los remaches sueltos.

Un choix polyvalent pour les cuisines professionnelles haut de gamme, la conception triple couches de la poêle Tribute® extrêmement durable offre une distribution parfaite de la chaleur pour des résultats impressionnants. Fréir, sauter ou saisir, cette poêle à induction avec revêtement antiadhésif haut de gamme CeramiGuard® II offre un démoulage exceptionnellement souple et un nettoyage facile. Le nouveau manche offre un toucher froid et une prise ergonomique plus confortable, tandis que le système Ever-Tite promet une garantie limitée à vie contre les rivets desserrés.



## 6914 Non-stick fry pan Sartén antiadherente Poêle anti-adhésive

REF	Ø cm	H cm	☐
691407	18	4	1
691408	20	4	1
691410	24	5	1
691412	28	5	1
691414	32	6	1

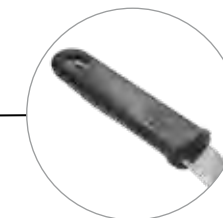

Also available with silicone handle.  
También disponible con mango silicona.  
Également disponible avec poignée en silicone.

Professional ergonomic handle resistant to high temperatures. Patented by Vollrath.

Mango ergonómico profesional resistente a altas temperaturas. Patentado por Vollrath.

Manche ergonomique professionnel résistant aux températures élevées. Breveté par Vollrath.

Durable 3-ply construction provides exceptional heat distribution.

Cuerpo de multi-metal para una excepcional distribución del calor.  
Corps multimétal pour une distribution exceptionnelle de la chaleur.

CeramiGuard® II nonstick coating  
Antiadherente CeramiGuard® II  
Anti-adhésif CeramiGuard® II

### 3.3 St/steel

Acero inoxidable  
Acier inoxydable

SS  
Stainless  
steel

FRY PANS  
SARTÈNS  
POÈLES

## INOX PRO

INDUCTION

FCA  
FOOD CONTACT  
APPROVED



BEST  
SELLER

**P220** Non-stick "ERGOS" excalibur fry pan  
Sartén antiadherente excalibur "ERGOS"  
Poêle anti-adhésive excalibur "ERGOS"



REF	Ø cm	H cm	
P220018	18	3,5	1
P220020	20	3,8	1
P220022	22	4,2	1
P220024	24	4,6	1
P220026	26	5,0	1
P220028	28	5,5	1
P220032	32	6,0	1
P220036	36	6,0	1
P220040	40	6,5	1

Non-stick coating  
Antiadherente  
Anti-adhésif

Sandwich bottom  
Fondo sandwich  
Fond sandwich

Probably the best frying pan in the world - maximum resistance to abrasion and long-lasting.

Probablemente la mejor sartén del mundo - máxima resistencia a la abrasión y de larga durabilidad.

Probablement la meilleure poêle du monde - résistance maximale à l'abrasion et longue durée de vie.

Non-stick coating treatment / Detalle tratamiento antiadherente / Détail application anti-adhésif



The surface of the substrate is blasted with an abrasive to roughen it, so other elements in the Excalibur process adhere to it better.

Para dar rugosidad a la superficie de la pieza se chorrea con elementos abrasivos y con ello se logra un buen anclaje del Excalibur.

Afin de la rendre rugueuse, la surface de la pièce est sablée avec un abrasif; ceci permettra une excellente tenue du procédé Excalibur.



Then, the most important part: White-hot particles of a special stainless steel (Whitford's patented alloy) are sprayed onto the roughened surface.

La parte más importante del proceso: la pulverización y deposición de las partículas fundidas de una aleación de acero inoxidable, patentada por Whitford.

Le processus plus important: des particules d'un acier inoxydable spécial (protégé par brevet par Whitford) sont chauffées à blanc et pulvérisées sur la pièce.



The particles cool and harden, bonded to the surface, forming a series of "peaks and valleys" that provide a permanent base for the non-stick coatings.

Las partículas se enfrían, formando parte integral de la superficie con "picos" y "valles" que permiten alojar las capas de antiadherente de forma permanente.

Ces particules se refroidissent, forment des crêtes et des vallées constituant une excellente base permanente d'accrochage et de renforcement de l'anti-adhésif.



Several coats of tough fluoropolymers fill the "valleys" and cover the "peaks", held permanently in place by the special stainless steel "peaks".

Finalmente se aplican varias capas de fluoropolímeros que rellenan los "valles" y cubren los "picos", que protegen el recubrimiento antiadherente.

Des couches d'anti-adhésif très résistantes sont appliquées; elles remplissent les vallées, recouvrent juste le haut des crêtes qui les maintiennent fermement en place.

### St/steel 3.3

Acero inoxidable  
Acier inoxydable

SS  
Stainless  
steel

FRY PANS  
SARTÈNS  
POÈLES

## COOL-LINE

**P4902CO** Non-stick fry pan  
Sartén antiadherente  
Poêle anti-adhésive

INDUCTION  
induction gas vitro electric

Non-stick coating  
Antiadherente  
Anti-adhésif



REF	Ø cm	H cm	
P490220 + COLOR	20	3,8	1
P490224 + COLOR	24	4,6	1
P490228 + COLOR	28	5,5	1

Sandwich bottom / Fondo sandwich / Fond sandwich

Ref. colour / Ref. color / Ref. couleur couvercle



See products on  
Ver productos en / Voir produits en page **P. 54**



## INTENSIVE

**P2208** Fry pan with ceramic non-stick coating  
Sartén antiadherente cerámico  
Poêle revêtement anti-adhésif céramique

INDUCTION  
induction gas vitro electric

CLASS INDUCTION  
PFOA FREE  
Non-stick coating  
Antiadherente  
Anti-adhésif



REF	Ø cm	H cm	
P220820	20	3,8	1
P220824	24	4,6	1
P220828	28	5,5	1
P220832	32	6,0	1

## EXPERT

**P213** "EXPERT" fry pan  
Sartén "EXPERT"  
Poêle "EXPERT"

INDUCTION  
induction gas vitro electric

CLASS  
INDUCTION



Sandwich bottom  
Fondo sandwich  
Fond sandwich

REF	Ø cm	H cm	
P213018	18	3,5	1
P213020	20	3,8	1
P213022	22	4,2	1
P213024	24	4,6	1
P213026	26	5,0	1
P213028	28	5,5	1
P213032	32	6,0	1
P213036	36	6,0	1
P213040	40	6,5	1

### 3.3 St/steel

Acero inoxidable  
Acier inoxydable



**P2393** Round base wok  
Wok fondo redondo  
Wok à fond rond

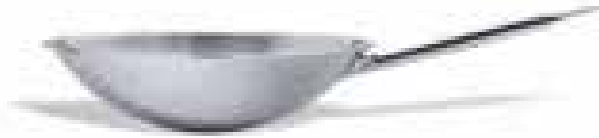
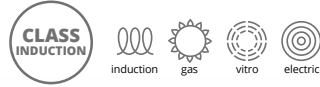

REF	Ø cm	H cm	Lts	
P239336	36	10,0	6,00	1

**P2392** Flat base wok  
Wok fondo plano  
Wok à fond plain

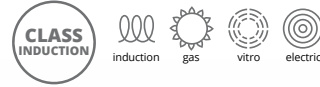

REF	Ø cm	H cm	Lts	
P239236	36	9,0	5,50	1

See products on  
Ver productos en / Voir produits en page

P. 291

Countertop induction wok  
Placa de inducción wok 35 cm  
Plaque wok induction 35 cm



## IDEA

**P459** Fry pan  
Sartén  
Poêle

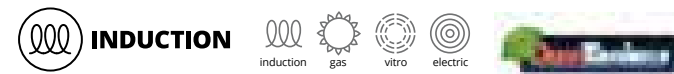

ALL OVER  
TECH

REF	Ø cm	H cm	
P459020	20	4,5	1
P459024	24	5,0	1
P459028	28	5,5	1

### Aluminum 3.4

Aluminio  
Aluminium



FOOD CONTACT  
APPROVED

## ALU PRO



**P1289** Non-stick induction fry pan "HERCULES"  
Sartén antiadherente fondo inducción "HERCULES"  
Poêle anti-adhésive fond induction "HERCULES"

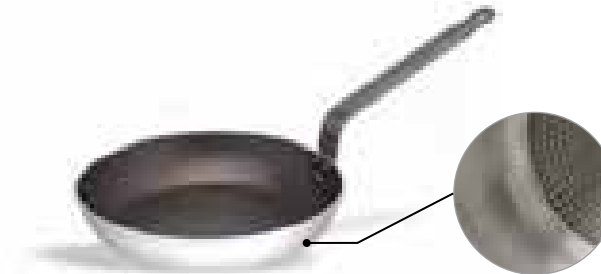

St/Steel sheet induction bottom  
Fondo chapa inox. inducción  
Fond plaque inox. induction

REF	Ø cm	H cm	
P128920	20	4,0	12
P128924	24	4,5	6
P128928	28	5,0	6
P128932	32	5,5	6

**P1209** Non-stick induction fry pan "ERGOS"  
Sartén antiadherente fondo inducción "ERGOS"  
Poêle anti-adhésive fond induction "ERGOS"



St/Steel sheet induction bottom  
Fondo chapa inox. inducción  
Fond plaque inox. induction

REF	Ø cm	H cm	
P120920	20	4,0	12
P120924	24	4,5	6
P120928	28	5,0	6
P120932	32	5,5	6

**P1208** Fry pan with ceramic non-stick coating  
Sartén con antiadherente cerámico  
Poêle à revêtement anti-adhésif céramique

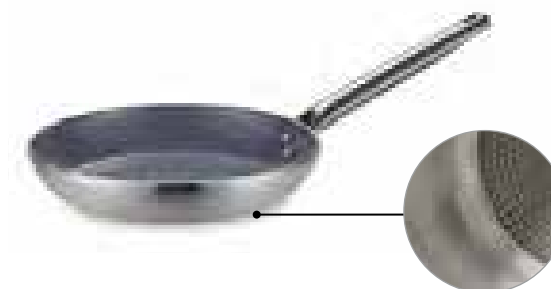

St/Steel sheet induction bottom  
Fondo chapa inox. inducción  
Fond plaque inox. induction

REF	Ø cm	H cm	
P120820	20	4,0	12
P120824	24	4,5	6
P120828	28	5,0	6
P120832	32	5,5	6

# 3.4 Aluminum

Aluminio  
Aluminium



FRY PANS  
SARTÉNS  
POÊLES



## ALU PRO

Made of aluminium with non-stick coating, suitable for any kind of stove except induction and oven.

Fabricadas en aluminio con recubrimiento antiadherente, adaptadas a todo tipo de cocinas excepto inducción. No aptas para hornos.

Fabriquées en aluminium avec revêtement anti-adhésif, recommandées pour tout type de feux, sauf induction. Ne pas utiliser aux fours.



**P120** Non-stick fry pan "ERGOS"  
Sartén antiadherente "ERGOS"  
Poêle anti-adhésive "ERGOS"

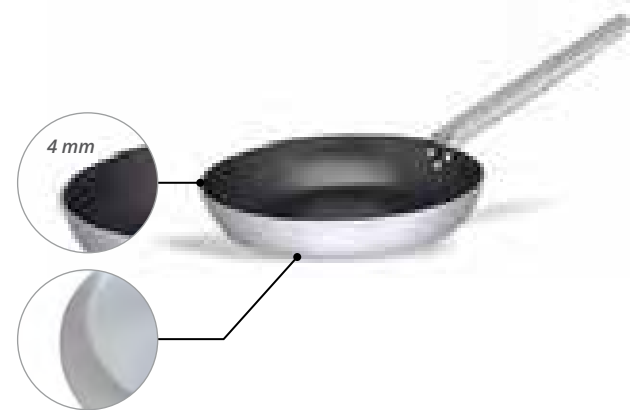

Plain base  
Fondo plano  
Fond plain

REF	Ø cm	H cm	
P120018	18	4,0	12
P120020	20	4,0	12
P120022	22	4,5	12
P120024	24	4,5	6
P120026	26	5,0	6
P120028	28	5,0	6
P120032	32	5,5	6
P120036	36	6,0	6
P120040	40	6,5	6

**P128** Non-stick fry pan "HERCULES"  
Sartén antiadherente "HERCULES"  
Poêle anti-adhésive "HERCULES"



Plain base  
Fondo plano  
Fond plain

REF	Ø cm	H cm	
P128018	18	4,0	12
P128020	20	4,0	12
P128022	22	4,5	12
P128024	24	4,5	6
P128026	26	5,0	6
P128028	28	5,0	6
P128032	32	5,5	6
P128036	36	6,0	6
P128040	40	6,5	6

# Aluminum 3.4

Aluminio  
Aluminium



## ALU PRO SPECIAL



**P128** Non-stick FRY PAN "HERCULES" Coloured handles  
Sartén antiadherente "HERCULES" mango colores  
Poêle anti-adhésif "HERCULES" Queue à couleurs



- Red meat / Carnes rojas / Viande rouge
- White meat and eggs / Carnes blancas y huevos / Volaille et oeufs
- Fish / Pescado / Poisson
- Vegetables / Verdura / Legumes

Ref: P128 + (Colour / Color / Couleur) + Ø

REF	Red Rojo Rouge	Yellow Amarillo Jaune	Blue Azul Bleu	Green Verde Vert	Ø cm	H cm	
P128	1	2	3	4	24	4,5	12
P128	1	2	3	4	28	5,0	12
P128	1	2	3	4	32	5,5	6

**P127** Fry pan "ERGOS" expert  
Sartén "ERGOS" expert  
Poêle "ERGOS" expert



REF	Ø cm	H cm	
P127024	24	4,5	1
P127028	28	5,0	1
P127032	32	5,5	1
P127040	40	6,5	1

**P192** Non-stick light . Frying pan "ALU-FIRST"  
Sartén antiadherente ligera "ALU-FIRST"  
Poêle antiadhesive légère "ALU-FIRST"



Sold in whole boxes only  
Se venden sólo por cajas completas  
Vendues uniquement par boîtes complètes

REF	Ø cm	H cm	
P192118	18	4,0	12
P192120	20	4,0	12
P192124	24	4,5	6
P192128	28	5,0	6
P192132	32	5,5	6
P192136	36	6,0	6
P192140	40	6,5	6

**P148** Non-stick sauté pan "ERGOS"  
Sartén honda "ERGOS" antiadherente  
Sauteuse évasée en anti-adhésive "ERGOS"



REF	Ø cm	H cm	
P148020	20	6,5	1
P148024	24	7,0	1
P148028	28	7,5	1
P148032	32	8,0	1

FRY PANS  
SARTÉNS  
POÊLES

## 3.4 Aluminum

Aluminio  
Aluminium



### ALU PRO SPECIAL



**P124** Non-stick paella pan  
Paellera antiadherente  
Plat à paella anti-adhésif



St/Steel handle  
Asas de acero inox  
Anses en acier inox

REF	Ø cm	H cm	
P124024	24	4,5	1
P124028	28	5,0	1
P124032	32	5,5	1
P124036	36	6,0	1
P124040	40	6,5	1

**P131** Non-stick crêpe fry pan "HERCULES"  
Sartén para crêpes "HERCULES" antiadherente  
Poêle à crêpes "HERCULES" anti-adhésive



REF	Ø cm	H cm	
P131022	22	2,5	12
P131026	26	2,5	12

**P125** Non-stick FRY pan for fish "ERGOS"  
Sartén pescado "ERGOS" antiadherente  
Poêle à poisson "ERGOS" anti-adhésive



REF	cm	H cm	
P125038	38 x 26	5	1

**P139** Non-stick blinis fry pan  
Sartén para blinis antiadherente  
Poêle à blinis anti-adhésive



**IDEA!** Specially for fried egg  
Especial para huevo frito  
Spécialement pour œuf frit

REF	Ø cm	H cm	
P139012	12	2	36

### EASY APOLO

**P460** Aluminium non-stick fry pan. Bakelite handle  
Sartén aluminio antiadherente. Mango baquelita  
Poêle aluminium anti-adhésive. Queue en bakélite



REF	Ø cm	H cm	
P460018	18	4,0	12
P460020	20	4,0	12
P460024	24	4,0	12
P460026	26	4,5	12
P460028	28	4,5	12
P460030	30	4,5	12
P460032	32	5,0	12



## Multi-ply 3.5

Multimetal  
Multi-metal

### MULTI-PLY



It gets all advantages of the aluminium and the st/steel just in one

Aporta todas las ventajas del aluminio y del acero inoxidable en una sola pieza

Apporte tous les avantages de l'aluminium et de l'acier inoxydable en une seule pièce

**P2390** Round base wok  
**P2394** Wok fondo redondo  
Wok à fond rond

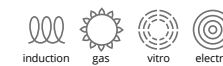

**\* Non-stick coating**  
Antiadherente  
Anti-adhésif



P239036

**P2391** Flat base wok  
**P2395** Wok fondo plano  
Wok à fond plain



**\* Non-stick coating**  
Antiadherente  
Anti-adhésif

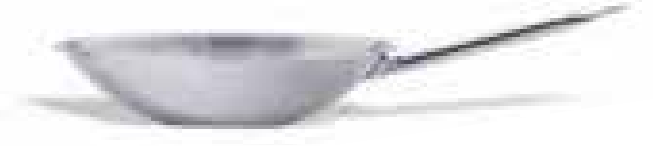

P239136



P239436\*



P239536\*

REF	Ø cm	H cm	Lts	
P239036	36	10	6	1
P239436*	36	10	6	1

REF	Ø cm	H cm	Lts	
P239136	36	9	5,5	1
P239536*	36	9	5,5	1



## 3.6 Cast aluminum

Aluminio fundición  
Fonte d'aluminium



### BLACK PRO

Manufactured in cast aluminium with excellent resistance to deformation and with excellent thermal properties.

Fabricada en aluminio de fundición de gran resistencia a la deformación y con excelentes prestaciones térmicas.

Fabriqué en fonte d'aluminium très résistante à la déformation et dotée d'excellentes performances techniques.



**Tubular stainless steel handle**  
Mango tubular de acero inoxidable  
Manche tubulaire en acier inoxydable

**Highly resistant Eterna non-stick surface**  
Antiadherente Eterna de alta resistencia  
Antiadhesif permanent très résistant

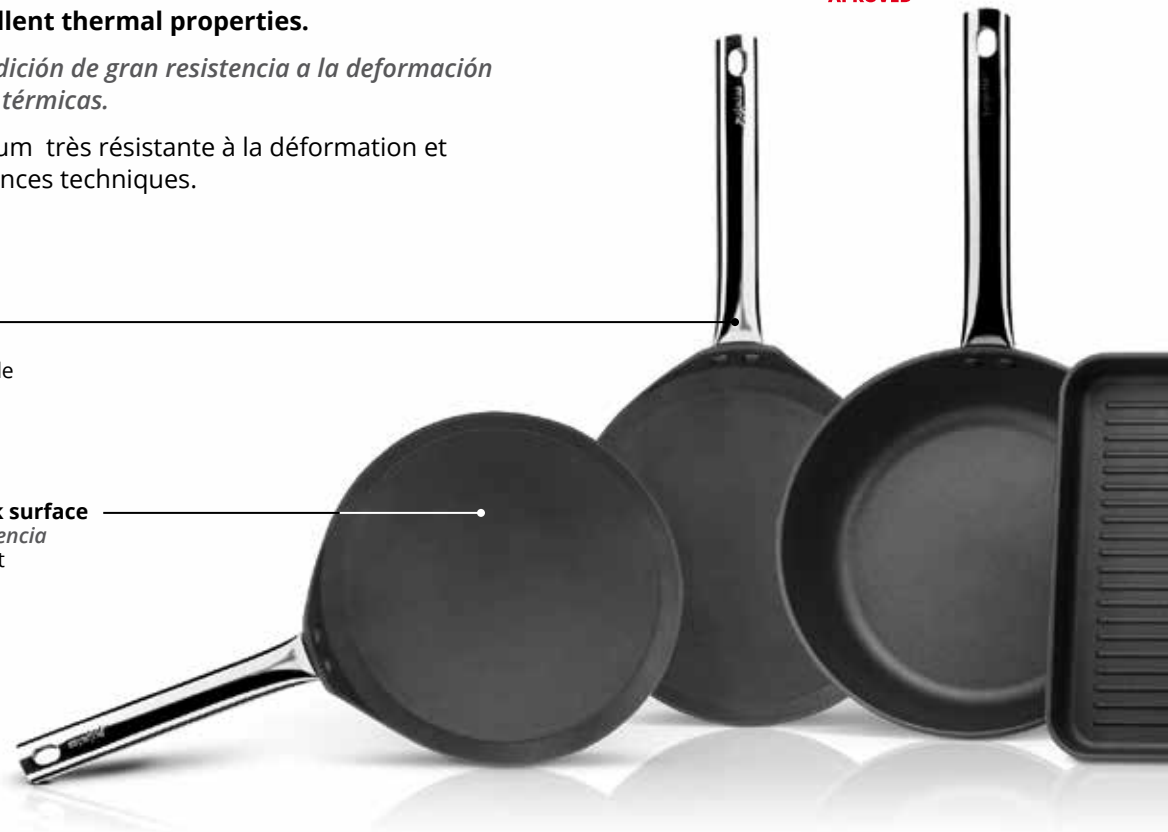

**P1491 Fry pan st/steel handle**  
Sartén mango inox  
Poêle manche inox



REF	Ø cm	H cm	
P149120	20	5	4
P149124	24	5	4
P149128	28	5	4
P149130	30	5	4

**P1492 Deep fry pan st/steel handle**  
Sartén honda mango inox  
Poêle haute manche inox



REF	Ø cm	H cm	
P149228	28	7,5	4

## Cast aluminum 3.6

Aluminio fundición  
Fonte d'aluminium



**P1493 Wok st/steel handle**  
Wok mango inox  
Wok manche inox



REF	Ø cm	H cm	
P149330	30	9,5	4

**P1421 Grill st/steel handle**  
Asador grill mango inox  
Grill manche inox



REF	W x D x H cm	
P142100	28 x 28 x 4	1

**P153034 Hot-plate with handles**  
Parrilla plana con asas  
Grill plat avec poignées



REF	W x D x H cm	
P153034	34 x 26 x 2,5	6

**P1501 Crêpe fry pan st/steel handle**  
Sartén crêpes mango inox  
Poêle à crêpes manche inox



REF	Ø cm	H cm	
P150128	28	1,5	4

**P153025 Hot-plate with handles**  
Parrilla plana con asas  
Grill plat avec poignées



REF	W x D x H cm	
P153025	25 x 25 x 2	1

**P153050 Hot-plate with handles**  
Parrilla plana con asas  
Grill plat avec poignées



REF	W x D x H cm	
P153050	50 x 30 x 2,5	4

## 3.6 Cast aluminum

Aluminio fundición  
Fonte d'aluminium



### BLACK FORGED SOFT TOUCH



FOOD CONTACT APPROVED

FULL INDUCTION



Full induction base  
Fondo inducción completo  
Fond à induction complet

**P1495** Forged aluminium frying pan  
Sartén aluminio forjado  
Poêle en aluminium revêtu

FULL INDUCTION



Frying pan manufactured in high-resistance forged aluminium which offers excellent energy efficiency thanks to its full induction base with a soft-touch bakelite handle, resistant to temperatures up to 160 °C.

Sartén fabricada en aluminio forjado de alta resistencia que ofrece una gran eficiencia energética gracias a su fondo inducción completo, con mango de baquelita soft touch resistente a una temperatura máxima de 160 °C.

Poêle fabriquée en aluminium revêtu très résistant, offrant une grande efficacité énergétique, grâce à son fond à induction complet avec manche en bakélite soft touch résistant à une température maximale de 160°C.

REF	Ø cm	H cm	
P149520	20	5,0	1
P149524	24	5,5	1
P149528	28	6,0	1

### BLACK FIRST

NO INDUCTION

**P150** Crêpe fry pan bakelite handle  
Sartén crêpes mango baquelita  
Poêle à crêpes manche bakélite



Cast aluminium  
Aluminio de fundición  
Fonte d'aluminium



REF	Ø cm	H cm	
P150028	28	2,0	12

**P142** Grill wooden handle  
Asador grill mango madera  
Grill queue en bois



Cast aluminium  
Aluminio de fundición  
Fonte d'aluminium



REF	W x D x H cm	
P142000	29 x 29 x 4,3	5

## Steel 3.7

Acero  
Acier



### STEEL PRO 1921 SERIES



FOOD CONTACT APPROVED

FULL INDUCTION

Heatproof ergonomic handle  
Mango ergonómico, resistente al calor  
Manche ergonomique, résistant à la chaleur

Light cast steel fry pan easy to use  
Sartén de acero de fundición ligero de fácil manejo  
Poêle en fonte d'acier léger, facile à manipuler

**40%**  
Less weight than traditional iron pans  
Menos de peso que las sartenes tradicionales de hierro  
De poids en moins par rapport aux poêles en fer traditionnelles

Extraordinary calorific properties.  
Excellent and uniform heat distribution  
Extraordinarias propiedades calóricas.  
Excelente y homogénea distribución del calor  
Propriétés calorifiques extraordinaires.  
Excellent et homogène distribution de la chaleur

Last generation three layers non-stick coating. PFOA FREE  
Tres capas de antiadherente de última generación, libre de PFOA  
Trois couche anti-adhésive de dernière génération. Libre de PFOA

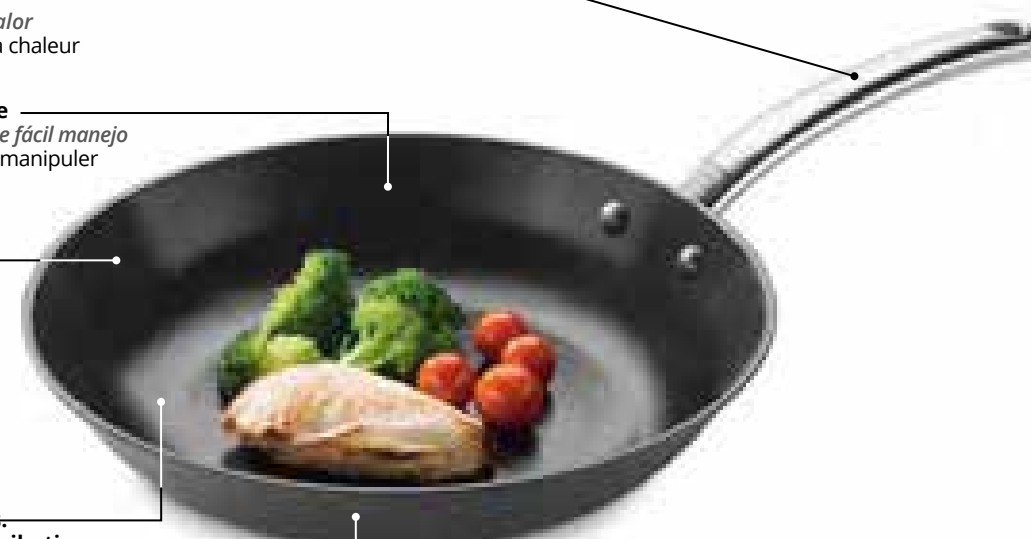

**IDEA!** For a quick and healthy cooking, it enables you to cook meats, fish, vegetables using high heat and very little oil.  
Para una cocina rápida y sana, permite cocinar carnes, pescados y verduras a fuego alto, usando muy poco aceite.  
Pour une cuisine rapide et saine, permettant de cuisiner les viandes, poissons et légumes à feu vif, en utilisant très peu d'huile.

**P169** Fry pan  
Sartén  
Poêle



REF	Ø cm	H cm	
P169020	20	4,5	1
P169024	24	4,5	1
P169028	28	5,5	1
P169030	30	5,5	1

**P166** Wok with lid  
Wok con tapa  
Wok avec couvercle

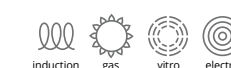

Glass lid included  
Tapa de cristal incluida  
Couvercle en verre inclus

REF	Ø cm	H cm	Lts	
P166032	32	8,0	4,40	1



St  
Steel

**Steel 3.7**

Acero  
Acier

# STEEL CLASSIC



**Hercules long handle**  
Mango hércules  
Manche hercules

**Excellent thermal and natural nonstick properties**  
Excelentes propiedades térmicas y antiadherentes naturales  
Excellentes propriétés thermiques et antiadhésives naturelles

**Manufactured in steel**  
Fabricadas en acero  
Fabriquées en acier



**P1351** "Lyonnaise" Steel fry pan 1,5 mm  
Sartén "Lionesa" 1,5 mm  
Poêle "Lyonnaise" 1,5 mm



REF	Ø cm	H cm	
P135120	20	4,5	1
P135124	24	5,0	1
P135128	28	5,5	1
P135132	32	6,0	1
P135140	40	7,0	1

**P1353** Wok



REF	Ø cm	H cm	
P135330	30	9,5	1

**P1354** Crêpe fry pan  
Sartén para crêpes  
Poêle à crêpes



REF	Ø cm	H cm	
P135424	24	2,0	1

FRY PANS  
SARTÉNS  
POÊLES

# 3.8 Spanish paella pan

Paellera  
Plat à paella



**P994** Black steel spanish paella pan  
*Paellera valenciana en acero pulido*  
Plat à paella tôle acier



REF	Ø cm	Portions / Raciones	
P994020	20	1	1
P994022	22	1	1
P994024	24	1	1
P994026	26	2	1
P994030	30	4	1
P994032	32	5	1
P994034	34	6	1
P994036	36	7	1
P994038	38	8	1
P994040	40	9	1
P994042	42	10	1
P994046	46	12	1
P994050*	50	14	1
P994055*	55	16	1
P994065*	65	22	1
P994080*	80	40	1
P994090*	90	50	1

\* Models also available in 3mm thickness.  
*Modelos también disponibles en 3mm de grosor.*  
*Modèles également disponibles en épaisseur 3 mm*

**P995** Enamelled steel paella pan  
*Paellera acero esmaltado*  
Plat à paella acier émaillé



REF	Ø cm	Portions / Raciones	
P995010 *	10	-	1
P995016 *	15	-	1
P995020	20	2	1
P995026	26	2	1
P995030	30	4	1
P995034	34	6	1
P995036	36	7	1
P995038	38	8	1
P995040	40	9	1
P995042	42	10	1
P995050	50	14	1
P995060	60	19	1

**P997** Deep enamelled fry pan with handles  
*Sartén honda esmaltada con asas*  
Poêle haute avec anses



REF	Ø cm	Lts	
P997014 *	14	0,40	1
P997016 *	16	0,50	1
P997028	28	3,90	1
P997032	32	5,30	1
P997036	36	7,80	1
P997040	40	9,40	1

**\*MINI-SIZE**  
 **Recommended for snacks**  
*Ideal para tapas*  
*Recommandé pour tapas*



# Spanish paella pan 3.8

Paellera  
Plat à paella

**Burners**  
*Paelleros*

**P998** Enamelled gas burner  
*Paellero esmaltado gas*  
Brûleur émaillé



**P998035**  
**For paella pans from Ø 20 to 50 cm**  
*Para paelleras de 20 a 50 cm Ø*  
*Pour plats à paella de 20 à 50 cm Ø*

**P998050**  
**For paella pans from Ø 36 to 70 cm**  
*Para paelleras de 36 a 70 cm Ø*  
*Pour plats à paella de 36 à 70 cm Ø*

**P998070**  
**For paella pans from Ø 36 to 90 cm**  
*Para paelleras de 36 a 90 cm Ø*  
*Pour plats à paella de 36 à 90 cm Ø*

**Valid only for gas butane and propane**  
*Válido para gas butano y propano NO para gas ciudad*  
*Valable uniquement pour gaz butane et propane*

REF	Ø cm	Circles / Círculos / Cercles	Kw	
P998035	35	2	9,4	1
P998050	50	2	14,1	1
P998070	70	3	24,1	1

**P999** Base for burner  
*Tripode paellero*  
Pied pour brûleur



**Folding valid for 2 and 3 circles burners**  
*Plegable apto para paelleros de 2 y 3 círculos*  
*Pliant valable pour brûleurs de 2 et 3 cercles*

REF	
P999000	1

See products on / Ver productos en / Voir produits en page

P. 465

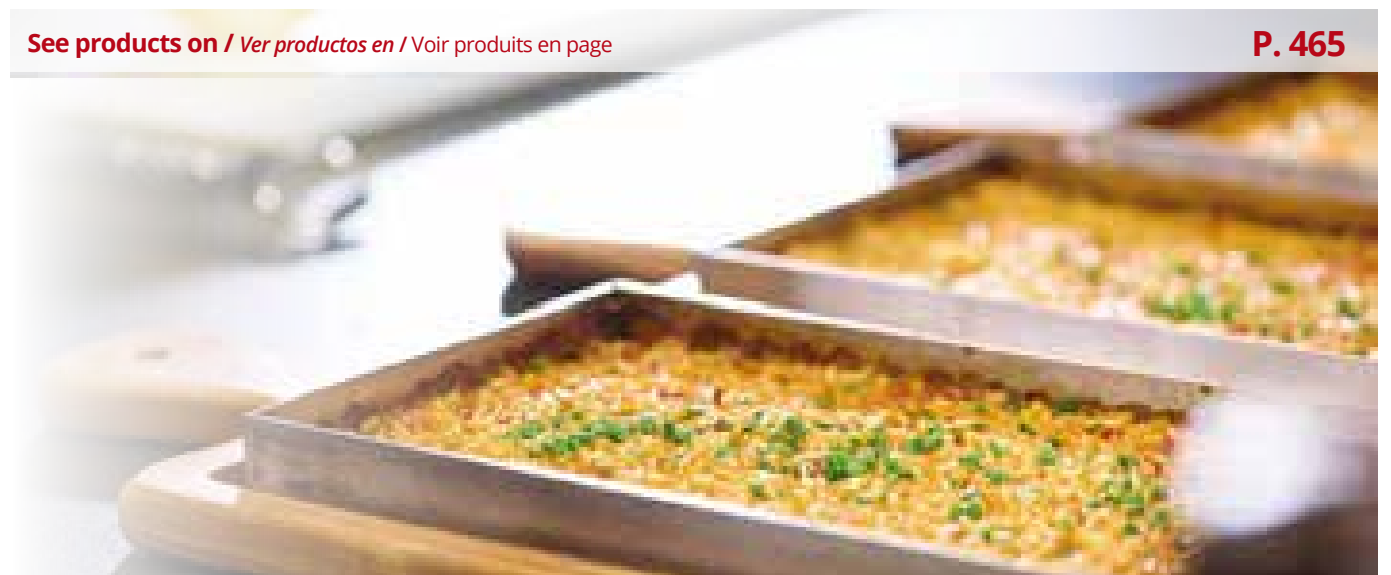

# 4 Oven and roast pan

*Horno y rustideras*  
Four et plaques à rôtir



## 4.1 ROAST PANS 88

*RUSTIDERAS*  
PLAQUES À RÔTIR

## 4.2 GASTRONORM SHEET PANS 89

*BANDEJAS HORNO GASTRONORM*  
PLAQUES FOUR GASTRONORME

## 4.3 PASTRY TRAYS 90

*BANDEJAS PASTELERÍA*  
PLAQUES À PÂTISSERIE

## 4.4 GRIDS 92

*REJILLAS*  
GRILLES

## 4.5 PIZZA BAKING SHEETS 93

*BANDEJAS PARA PIZZA*  
PLAQUES À PIZZA

## 4.6 OVEN ACCESSORIES 95

*ACCESORIOS HORNO*  
ACCESSOIRES FOUR

## 4.1 Roast pans

Rustideras  
Plaques à rôtir



**P309** Roast pan falling handles  
Rustidera asas móviles  
Plaque à rôtir anses tombantes

18/10  
Stainless steel



REF	cm (int)	cm (ext)	H cm	Lts	
P309040	40 x 30	43 x 33	6,5	6,5	1
P309050	50 x 35	54 x 39	7,0	11,0	1
P309060	60 x 40	64 x 44	9,0	19,0	1

**P113** Roast pan falling handles  
Rustidera asas móviles  
Plaque à rôtir anses tombantes

AI  
Aluminium



REF	W x D x H cm	Lts	
P113035	35 x 27 x 5,5	5,0	1
P113040	40 x 30 x 6,5	6,3	1
P113050	50 x 35 x 7	10,8	1
P113060	60 x 40 x 9	19,0	1
P113070	70 x 45 x 10	27,7	1

**P122** Non-stick roast pan falling handles  
Rustidera antiadherente asas móviles  
Plaque à rôtir anti-adhésive anses tombantes

AI  
Aluminium



REF	W x D x H cm	Lts	
P122040	40 x 30 x 6,5	6,3	1
P122050	50 x 35 x 7	10,8	1
P122060	60 x 40 x 9	19,0	1

**P114** Roast pan fixed handles  
Rustidera asas fijas  
Plaque à rôtir avec poignées fixes

AI  
Aluminium



REF	W x D x H cm	Lts	
P114040	40 x 30 x 6,5	6,3	1
P114050	50 x 35 x 7	10,8	1
P114060	60 x 40 x 9	19,0	1
P114070	70 x 45 x 10	27,7	1

**P1145** BLACK ELEGANCE  
Non-stick presentation aluminium roast pan  
Rustidera aluminio presentación antiadherente  
Plaque à rôtir anti-adhésive présentation

AI  
Aluminium



REF	W x D x H cm	Lts	
P114540	40 x 30 x 6,5	6,3	1
P114545	45 x 32 x 6,5	7,6	1

**P152** Roast pan  
Rustidera  
Plaque à rôtir

AI  
Aluminium



\*MINI-SIZE

Ideal for food presentation  
Ideal para presentación  
Idéal pour présentation

REF	W x D x H cm	
P152025*	25 x 20 x 6,5	10
P152030	30 x 22 x 7	10
P152035	35 x 25 x 7,5	5

## Gastronorm sheet pans 4.2

Bandejas horno gastronorm  
Plaques four gastronorme



**P3180** Gastronorm sheet  
Bandeja gastronorm  
Plaque gastronorme

18/10  
Stainless steel



Thickness: 1 mm  
Grosor: 1 mm  
Epaisseur: 1 mm

REF	Type / tipo	W x D x H cm	
P318005	1/1	54 x 32 x 0,8	1

**P3182** Deep gastronorm sheet  
Bandeja honda gastronorm  
Plaque gastronorme fonde

18/10  
Stainless steel



Thickness: 0,8 mm  
Grosor: 0,8 mm  
Epaisseur: 0,8 mm

REF	Type / tipo	W x D x H cm	
P318211	1/1	54 x 32 x 2	1

**P1323** Non-stick GN pan tray  
Bandeja GN antiadherente  
Plaque GN anti-adhésive

AI  
Aluminium



Thickness: 3 mm  
Grosor: 3 mm  
Épaisseur: 3 mm

REF	Type / tipo	cm	H cm	Lts	
P132365	1/1	53 x 32,5	6,5	7,9	1

**P1325** Multi-units tray  
Bandeja multiunidades  
Plaque multi-unités

AI  
Aluminium

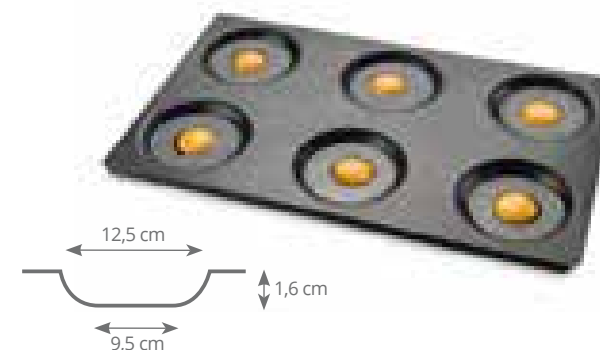

REF	Type / tipo	cm	
P132560	1/1	53 x 32,5	1

## 4.3 Pastry trays

Bandejas pastelería  
Plaques à pâtisserie



18/10  
Stainless steel

### P318 Baking sheet

Bandeja pastelería  
Plaques à pâtisserie



Thickness: 1 mm  
Grosor: 1 mm  
Épaisseur: 1 mm

REF	W x D x H cm	
P318040	40 x 30 x 1,2	1
P318060	60 x 40 x 1,2	1

### P779 Baking sheet

Bandeja pastelería  
Plaques à pâtisserie



Thickness: 0,7 mm  
Grosor: 0,7 mm  
Épaisseur: 0,7 mm

REF	W x D x H cm	
P779017	25,5 x 17,5 x 1	1
P779021	27,5 x 21 x 1	50
P779026	30 x 26 x 1	1
P779060	60 x 20 x 1	25

### P778 Tray for confectionery

Bandeja pastelería  
Plaques à pâtisserie



REF	W x D x H cm	
P778040	40 x 30 x 1	1
P778048	48 x 31 x 1	1
P778060	60 x 40 x 1	1

### P777 Rectangle for baking sheets

Marcos para bandejas escuadradas  
Rectangle pour plaques



Rectangles that are adaptable to the baking sheets of ref. P778, P1232 and P1322  
Marcos adaptables a las bandejas escuadradas de la ref. P778, P1232 y P1322  
Rectangles pour adapter aux plaques inox des refs. P778, P1232 et P1322

REF	W x D x H cm	
P777540	39,5 x 29,5 x 5	1
P777548	47,5 x 30,5 x 5	1
P777560	59,5 x 39,5 x 5	1

See products on / Ver productos en / Voir produits en page

P. 154

### GN Pastry Pan

Cubeta GN Pastelería  
Bac GN pâtisserie



## Pastry trays 4.3

Bandejas pastelería  
Plaques à pâtisserie

Al  
Aluminium

### P123 Tray for confectionery

Bandeja para pastelería  
Plaques à pâtisserie



REF	W x D x H cm	
P123040	40 x 30 x 1,2	1
P123060	60 x 40 x 1,2	1

### P1232 Tray for confectionery

Bandeja para pastelería  
Plaques à pâtisserie

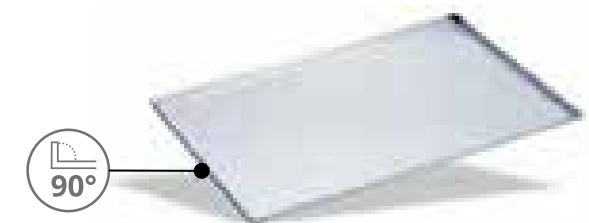

REF	W x D x H cm	
P123260	60 x 40 x 1,2	1

### P1321 Perforated non-stick tray for confectionery

Bandeja pastelería antiadherente perforada  
Plaques à pâtisserie anti-adhésive perforée



Ø holes 3 mm  
Ø agujeros 3 mm  
Ø trous 3 mm

REF	W x D x H cm	
P132140	40 x 30 x 1,2	1
P132160	60 x 40 x 1,2	1

### P1231 Perforated tray for confectionery

Bandeja perforada para pastelería  
Plaques à pâtisserie perforée



REF	W x D x H cm	
P123140	40 x 30 x 1,2	1
P123160	60 x 40 x 1,2	1

### P132 Non-stick tray for confectionery

Bandeja pastelería antiadherente  
Plaques à pâtisserie anti-adhésive



REF	W x D x H cm	
P132040	40 x 30 x 1,2	1
P132060	60 x 40 x 1,2	1

### P1322 Non-stick tray for confectionery

Bandeja pastelería antiadherente  
Plaques à pâtisserie anti-adhésive



REF	W x D x H cm	
P132260	60 x 40 x 1,2	1

## 4.4 Grids

Rejillas  
Grilles



### 9002 Baking sheet

Bandeja pastelería  
Plaque à pâtisserie

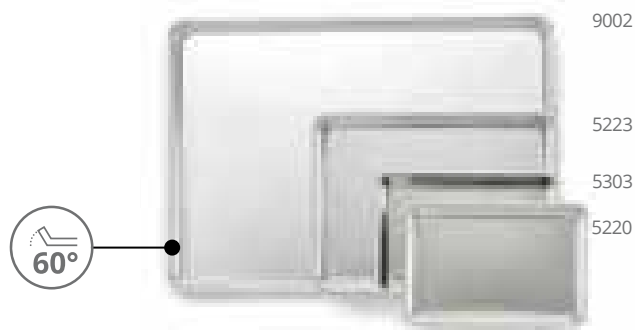

**IDEA!** 5220 / 5228  
Ideal for food presentation  
Ideal para presentación  
Idéal pour présentation

REF	W x D x H cm	📦
9002	45,1 x 65,4 x 0,25	12
5223	38,1 x 53,3 x 0,25	12
5303	45,1 x 32,7 x 0,25	12
5220	24,1 x 33,0 x 0,25	12
5228	24,1 x 16,5 x 0,25	12

### P9091 St/Steel gastronorm grid

Rejilla gastronorm acero inox  
Grille acier inoxydable gastronorm

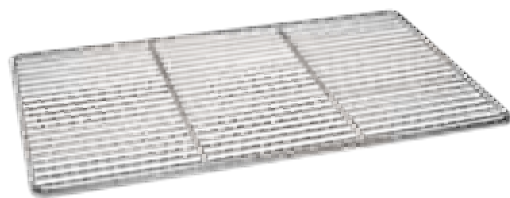

REF	Type	cm	N. Cross-bars Travesaños Traverses	Ø mm Cross-bars Travesaños Traverses	N. Wires Varillas Fils	Ø mm Cross-bars Travesaños Traverses	📦
P909121	2/1	65 x 53	3	5	32	2	10
P909111	1/1	53 x 32,5	2	5	20	2	10

### P9093 St/Steel pastry grid

Rejilla pastelería acero inox  
Grille pâtisserie acier inoxydable

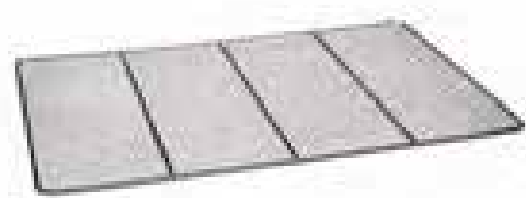

REF	cm	N. Cross-bars Travesaños Traverses	Ø mm Cross-bars Travesaños Traverses	N. Wires Varillas Fils	Ø mm Cross-bars Travesaños Traverses	📦
P909340	40 x 30	2	5	22	2	10
P909360	60 x 40	3	5	29	2	10

### P9094 St/Steel reinforced pastry grid

Rejilla pastelería reforzada acero inox  
Grille pâtisserie acier inoxydable renforcée



REF	cm	N. Cross-bars Travesaños Traverses	Ø mm Cross-bars Travesaños Traverses	N. Wires Varillas Fils	Ø mm Cross-bars Travesaños Traverses	📦
P909460	60 x 40	2	6	24	3	10

### P9092 White rilsan steel gastronorm grid

Rejilla gastronorm con rilsan blanco  
Grille gastronorm en acier et rilsan blanc

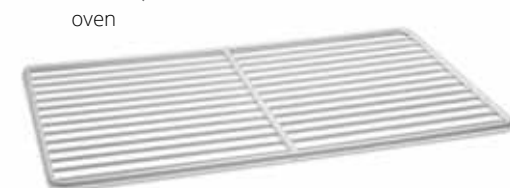

REF	Type	cm	N. Cross-bars Travesaños Traverses	Ø mm Cross-bars Travesaños Traverses	N. Wires Varillas Fils	Ø mm Cross-bars Travesaños Traverses	📦
P909221	2/1	65 x 53	3	5	22	5	1
P909211	1/1	53 x 32,5	2	5	13	5	1

## Pizza baking sheets 4.5

Bandejas para pizza  
Plaques à pizza



### 6706CC Pizza pan with Clear Coat® finish

Bases pizza con acabado Clear Coat®  
Bases pizza finition Clear Coat®

REF	Ø cm	H cm	📦
6706CC	16	3,8	12
6708CC	20	3,8	12
6709CC	22	3,8	12
6710CC	25	3,8	12
6712CC	30	3,8	12
6714CC	35	3,8	12
6716CC	40	3,8	12
PC07SCC	18	1,9	12
PC09SCC	22	1,9	12
PC10SCC	25	1,9	12
PC12SCC	30	1,9	12
PC15SCC	38	1,9	12
PC18SCC	45	1,9	12

### 6706HC Pizza pan with Hard Coat® finish

Bases pizza con acabado Hard Coat®  
Bases pizza finition Hard Coat®

REF	Ø cm	H cm	📦
6706HC	16	3,8	12
6708HC	20	3,8	12
6714HC	35	3,8	12
6716HC	40	3,8	12
PC07SHC	18	1,9	12
PC08SHC	20	1,9	12
PC09SHC	22	1,9	12
PC10SHC	25	1,9	12
PC11SHC	28	1,9	12
PC13SHC	32	1,9	12
PC14SHC	35	1,9	12
PC16SHC	40	1,9	12

### 6706N Pizza pan with natural finish

Bases pizza con acabado natural  
Bases pizza finition naturel

REF	Ø cm	H cm	📦
6706N	16	3,8	12
6708N	20	3,8	12
6709N	22	3,8	12
6710N	25	3,8	12
6712N	30	3,8	12
6714N	35	3,8	12
6716N	40	3,8	12
PC07SN	18	1,9	12
PC08SN	20	1,9	12
PC10SN	25	1,9	12
PC11SN	28	1,9	12
PC12SN	30	1,9	12
PC13SN	32	1,9	12
PC15SN	38	1,9	12
PC18SN	45	1,9	12

### PC07PCC Perforated pizza pan with Clear Coat® finish

Bases pizza perforadas con acabado Clear Coat®  
Bases pizza perforées finition Clear Coat®

REF	Ø cm	H cm	Holes Agujeros Troues	📦
PC07PCC	18	1,9	32	12
PC08PCC	20	1,9	52	12
PC10PCC	25	1,9	80	12
PC11PCC	28	1,9	112	12
PC12PCC	30	1,9	124	12
PC13PCC	33	1,9	156	12
PC14PCC	35	1,9	360	12
PC15PCC	38	1,9	208	12
PC18PCC	45	1,9	316	12

### PC07PHC Perforated pizza pan with Hard Coat® finish

Bases pizza perforadas con acabado Hard Coat®  
Bases pizza perforées finition Hard Coat®

REF	Ø cm	H cm	Holes Agujeros Troues	📦
PC07PHC	18	1,9	32	12
PC10FPHC	25	1,9	164	12
PC11PHC	28	1,9	112	12
PC12FPHC	30	1,9	256	12
PC12PHC	30	1,9	124	12
PC13PHC	33	1,9	156	12
PC14FPHC	35	1,9	360	12
PC14PHC	35	1,9	360	12
PC15PHC	38	1,9	208	12
PC16FPHC	40	1,9	468	12
PC18FPHC	45	1,9	616	12

### PC08PN Perforated pizza pan with natural finish

Bases pizza perforadas con acabado natural  
Bases pizza perforées finition naturel

REF	Ø cm	H cm	Holes Agujeros Troues	📦
PC08PN	20	1,9	52	12
PC10PN	25	1,9	80	12
PC11PN	28	1,9	112	12
PC12PN	30	1,9	124	12
PC14PN	35	1,9	360	12
PC15PN	38	1,9	208	12
PC16PN	40	1,9	468	12
PC18PN	45	1,9	316	12



## 4.5 Pizza baking sheets

Bandejas para pizza  
Plaques à pizza

**P705 Non-stick deep pizza mould**  
Molde hondo pizza antiadherente  
Moule haute pizza anti-adhésif



non-stick  
antiadherente  
antiadhésif



REF	Ø cm	H cm	
P705024	24	2,5	50
P705028	28	2,5	30
P705032	32	2,5	24

**P736 Perforated non-stick pizza mould**  
Molde pizza antiadherente perforado  
Moule à pizza anti-adhésif perforé



Ø 8 mm  
Holes  
Agujeros  
Trous



REF	Ø cm	H cm	
P736030	30	1,3	1
P736034	34	1,3	17

**P949 Non-stick aluminium pizza grill**  
Base rejilla aluminio antiadherente para pizza  
Base maillée aluminium anti-adhésive pour pizza



REF	Ø cm	
P949025	25,5	60
P949030	30,5	60
P949035	35,5	60
P949040	40,0	60

**P929 Aluminium pizza pan**  
Base pizza aluminio  
Plaques à pizza aluminium



REF	Ø cm	
P929025	25	100
P929028	28	1
P929030	30	50
P929036	36	50
P929040	40	50

**P963 Aluminium pizza grill**  
Base rejilla aluminio para pizza  
Base maillée aluminium pour pizza



REF	Ø cm	
P963025	25,0	144
P963030	30,5	144
P963035	35,5	72
P963040	40,0	72

## Oven accessories 4.6

Accesorios horno  
Accessoires four

**P833 Non-stick silicone mat**  
Tapete de silicona  
Toile de cuisson



- 40 °C  
+ 260 °C

REF	cm	
P833001	52 x 31,5	100
P833002	58,5 x 38,5	90
P833003	40 x 30	200

**P6071 Rost pan tong w/silicon protection**  
Pinza rustidera c/proteccion silicona  
Pinze plaque a/protetion silicone



REF	L cm	
P607100	18	120

**P948 Aluminium pizza peel**  
Pala pizza de aluminio  
Pelle à enfourner en aluminium

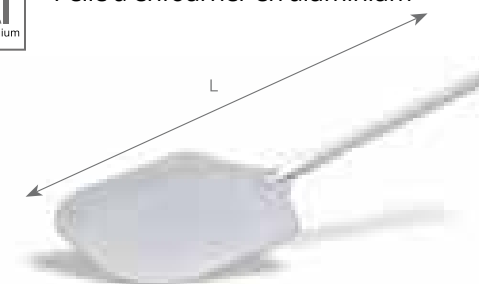

**P972 Siliconized baking release papers**  
Papel siliconado  
Papier siliconé anti-adhésif



Set of 500 units both sides siliconized. Multiple uses.  
Grammage 41 gr/m<sup>2</sup>. Greaseproof. Bleached.

Caja de 500 unidades. Siliconado por las dos caras. Múltiples usos.  
Gramaje 41 gr/m<sup>2</sup>. Resistente a la grasa. Color blanco.

Boîte de 500 unités. Deux faces siliconées. Multiples utilisations.  
Grammage 41 gr/m<sup>2</sup>. Résistant à la graisse. Couleur blanc.

REF	cm	Unit / Unidades	
P972060	60 x 40	500	1
P972053	53 x 32,5	500	1

**P607 Roast pan tong**  
Pinza fuente horno  
Pince pour plaque à rôtir



REF	L cm	
P607000	19	10

REF	Peel / Pala / Pelle cm	L cm	
P948066	31 x 35	66	24
P948090	31 x 35	90	24
P948132	31 x 35	132	24

# 5 Kitchen utensils

*Utensilios de cocina*  
Ustensiles de cuisine

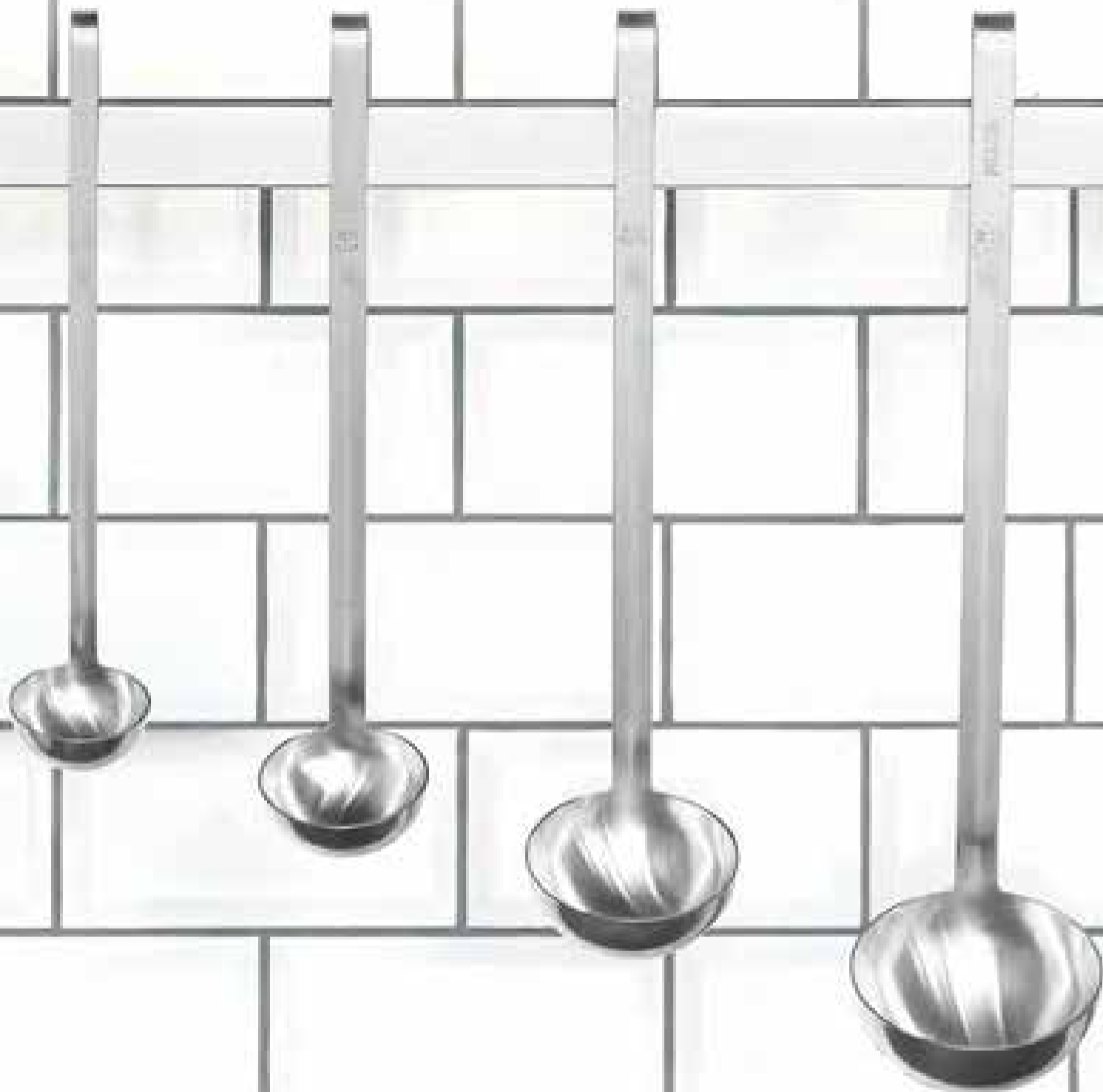

## 5.1 KITCHEN UTENSILS

*UTENSILIOS DE COCINA*  
USTENSILES DE CUISINE

98

## 5.2 MANUAL FOOD PROCESSORS

*PROCESADORES MANUALES DE ALIMENTOS*  
APPAREILS MANUELS DE TRANSFORMATION DES ALIMENTS

125

## 5.3 CUTTING BOARDS

*TABLAS DE CORTE*  
PLANCHES À DÉCOUPER

140

## 5.4 MEASURING UTENSILS

*ELEMENTOS DE MEDIDA*  
USTENSILES DE MESURE

143

## 5.5 MITT

*MANOPLA*  
GAN

149

## 5.6 NATURAL RUBBER MATS

*ALFOMBRAS CAUCHO*  
TAPIS EN CAOUTCHOUC

149

# 5.1 Kitchen utensils

Utensilios de cocina  
Ustensiles de cuisine

## P3011 One piece ladle

Cacillo monobloc  
Louche monobloc



Capacity marked on the handle  
Capacidad marcada en el mango  
Capacité marqué à la queue

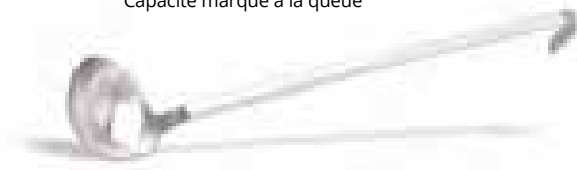

Ref	Ø cm	L cm	Lts	📦
P301165	6,5	31	0,07	120
P301108	8,0	32	0,13	80
P301109	9,0	33	0,20	60
P301110	10,0	37	0,25	40
P301112	12,0	42	0,45	30
P301114	14,0	43	0,75	20
P301116	16,0	45	1,00	20
P301118	18,0	48	1,50	20

## P3012 Economical one piece ladle

Cacillo monobloc económico  
Louche monobloc économique



Capacity marked on the handle  
Capacidad marcada en el mango  
Capacité marqué à la queue



Ref	Ø cm	L cm	Lts	📦
P301206	6	27	0,05	120
P301208	8	31	0,12	100
P301210	10	33	0,25	60
P301212	12	36	0,42	50
P301214	14	39	0,75	40
P301216	16	43	1,20	20

## P392 One piece sauce ladle with 2 spouts

Cacillo para salsas con 2 picos laterales  
Cuillère à sauces monobloc avec 2 becs verseurs



Capacity marked on the handle  
Capacidad marcada en el mango  
Capacité marqué à la queue

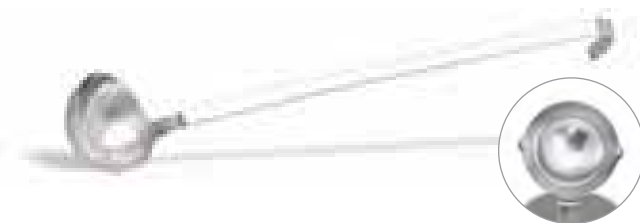

Ref	Ø cm	L cm	Lts	📦
P392065	6,5	31	0,08	120

## P30326 One piece ladle short handle

Cacillo monobloc mango corto  
Louche monobloc manche court



Capacity marked on the handle  
Capacidad marcada en el mango  
Capacité marqué à la queue



Ref	Ø cm	L cm	Lts	📦
P303265	6,5	22	0,07	120

## 4980120 One-Piece ladle Kool-Touch® handle

Cacillo monobloc Kool-Touch®  
Louche monobloc manche Kool-Touch®



Coated handle  
Revestimiento mango  
Revêtement queue

Ref	Color	Ø cm	L cm	ml	📦
4980120	Black	4,5	25,0	30	12
4980230	Blue	6,0	25,0	60	12
4980335	Yellow	7,5	32,0	90	12
4980445	Grey	8,5	32,0	120	12
4980655	Green	9,0	31,5	175	12
4980865	Orange	10,0	32,0	235	12

# Kitchen utensils 5.1

Utensilios de cocina  
Ustensiles de cuisine



## P3021 One piece skimmer

Espumadera monobloc  
Écumoire monobloc



Ref	Ø cm	L cm	📦
P302108	8	29	100
P302110	10	32	80
P302112	12	35	60
P302114	14	37	40
P302116	16	44	40
P302118	18	44	30
P302120	20	47	30

## P3022 Economical one piece skimmer

Espumadera monobloc económica  
Écumoire monobloc économique



Ref	Ø cm	L cm	📦
P302210	10	33	100
P302212	12	36	50
P302214	14	39	40
P302216	16	42	40

## P3141 One piece spatula

Espátula monobloc sin perforar  
Spatule monobloc



Ref	Ø cm	L cm	📦
P314110	10	36	50
P314112	12	39	50

## P3142 One piece perforated spatula

Espátula monobloc perforada  
Spatule monobloc perforée

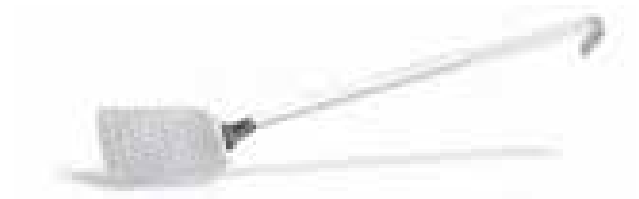

Ref	Ø cm	L cm	📦
P314210	10	36	50
P314212	12	39	50

## P3143 One piece fish spatula

Pala pescado monobloc  
Pelle à poisson monobloc



Ref	cm	L cm	📦
P314300	16 x 12	42	1

## P315 Mesh skimmer

Espumadera de alambre  
Écumoire à friture



Ref	Ø cm	L cm	📦
P315010	10	40,0	72
P315012	12	43,0	72
P315015	15	50,0	72
P315017	17	54,0	36
P315020	20	61,5	36

# 5.1 Kitchen utensils

Utensilios de cocina  
Ustensiles de cuisine



## P94101 Wire skimmer

Araña  
Araignée



REF	Ø cm	L cm	
P941013	13	47,5	60
P941015	15	49,5	60
P941018	18	52,5	40
P941020	20	54,5	40
P941022	22	67,0	40
P941024	24	69,0	40
P941028	28	69,0	40

## P955 Mesh skimmer

Espumadera malla fina  
Écumoire maillée



Detail of the sieve at real scale  
Detalle de la malla a escala real  
Détail de la maille à échelle réelle

REF	Ø cm	L cm	
P955010	10	40	72
P955012	12	43	72
P955015	15	50	72
P955017	17	54	36
P955020	20	61	36

## P394 Bird nest mould

Molde nido  
Moule à nid

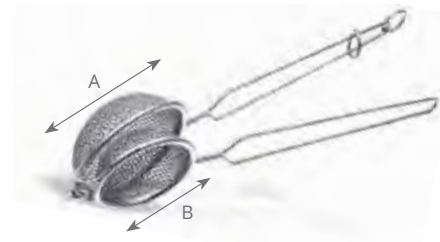

REF	Ø A cm	Ø B cm	
P394008	10	8	72
P394012	12	10	72

## P376 Professional one piece spoon

Cuchara monobloc profesional  
Cuillère monobloc professionnelle

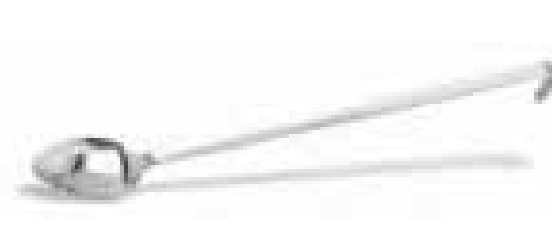

REF	Ø cm	
P376037	37	1

## P3761 Professional one piece deep spoon

Cuchara honda monobloc profesional  
Cuillère profonde monobloc professionnelle



REF	Ø cm	
P376137	37	100

## P377 Professional one piece perforated spoon

Cuchara perforada monobloc profesional  
Cuillère perforée monobloc professionnelle



REF	Ø cm	
P377037	37	1

# Kitchen utensils 5.1

Utensilios de cocina  
Ustensiles de cuisine



## P3771 Professional one piece perforated deep spoon

Cuchara honda monobloc profesional perforada  
Cuillère profonde monobloc professionnelle perforée



REF	Ø cm	
P377137	37	101

## P3972 2 prongs one piece meat fork

Tenedor monobloc 2 púas  
Fourchette monobloc 2 dents



2 prongs / 2 púas / 2 dents

REF	Ø cm	
P397247	47	1

## 64130 Solid spoons

Cuchara  
Cuillères pleines



232 °C

REF	Color	L cm	
64130	Black	35	12
6414015	White	35	12
6414030	Blue	35	12
6414040	Red	35	12
6414050	Yellow	35	12
6414070	Green	35	12

## 64134 Slotted serving Spoon

Cuchara de servir ranurada  
Cuillère de service fendue

NEW!



## P395 One piece crosswire spoon

Cuchara oblicua monobloc  
Cuillère oblique monobloc



REF	L cm	BASE cm	Lts	
P395038	38	10 x 7	0,075	1

## P3973 3 prongs one piece meat fork

Tenedor monobloc 3 púas  
Fourchette monobloc 3 dents



3 prongs / 3 púas / 3 dents

REF	L cm	
P397347	47	1

## 64132 Perforated spoons

Cuchara perforada  
Cuillères perforées



232 °C

REF	Color	L cm	
64132	Black	35	12
6414215	White	35	12
6414230	Blue	35	12
6414240	Red	35	12
6414250	Yellow	35	12
6414270	Green	35	12

REF	Color	L cm	
64134	Black	35	12

# Antimicrobial

Utensils with nature's antimicrobial

Utensilios con propiedades antimicrobiales naturales

Ustensiles avec traitement antimicrobien

It is not difficult to imagine the large number of microbes and micro-organisms that can live on the handles of kitchen utensils. Vollrath Pujadas has launched a range of tools that prevent them from reproducing, thanks to AGIO technology, with silver ions that hold on to the bacteria and prevent them reproducing.

No es difícil imaginar la gran cantidad de microbios y micro-organismos que se pueden alojar en los mangos de los utensilios de cocina. Vollrath Pujadas lanza una gama de herramientas que evita que éstos se reproduzcan, gracias a la tecnología AGIO, con iones de plata que retienen las bacterias y evitan su reproducción.

Il n'est pas difficile d'imaginer le grand nombre de microbes et de microorganismes présents sur les manches des ustensiles de cuisine. Vollrath Pujadas lance une gamme d'ustensiles qui empêchent leur reproduction, grâce à la technologie AGIO, aux ions d'argent qui stoppent les bactéries et empêchent leur reproduction.

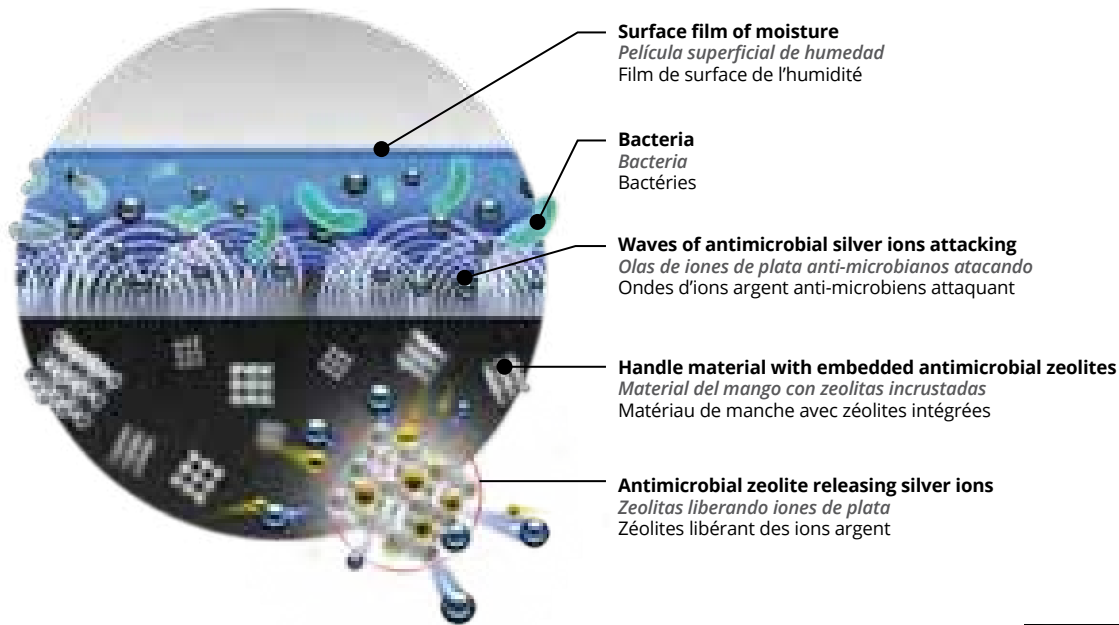

## SPOODLE®

Mirror-finished stainless steel shafts and bowls resistant to corrosion

Mango y porcionadores de acero inoxidable brillante resistente a la corrosión

Tiges et cuillerons en acier inoxydable ultra-brillant résistant à la corrosion

Capacity marked on the handle

Capacidad marcada en el mango  
Capacité marqué à la queue

Handle with ergonomic design, made from nylon which reduces wear during use. Maximum temperature 232 °C

Mango con diseño ergonómico, de Nylon que reduce la fatiga durante su uso. Max. temp. 232 °C

Manche au design ergonomique en nylon qui réduit la fatigue pendant son emploi. Temp. Max. 232 °C



# Kitchen utensils 5.1

Utensilios de cocina

Ustensiles de cuisine

**6433 One-piece round Spoodle®**  
Spoodle® monobloc redondo  
Spoodle® monobloc ronde



REF		Ø cm	L cm	ml	
6433120	Black	5,0	31	29	12 NEW
6433220	Black	6,5	32	60	12 NEW
6433230	Blue	6,5	32	60	12
6433335	Orange	7,4	33	90	12
6433445	Grey	8,2	34	120	12
6433480	Purple	3,2	33	118	12 NEW
6433620	Black	9,3	35	177	12 NEW
6433655	Teal	9,3	35	175	12
6433865	Orange	10,2	36	235	12

**6412 One-piece oval Spoodle®**  
Spoodle® Monobloc ovalado  
Spoodle® Monobloc ovale



REF		L cm	ml	
6412120	Black	32	29	12
6412230	Blue	33	59	12
6412335	Orange	34	88	12
6412420	Black	34	88	12
6412445	Grey	35	118	12
6412520	Black	35	147	12
6412655	Teal	36	177	12
6412865	Orange	37	236	12

**6422 Perforated oval Spoodle®**  
Spoodle® perforado ovalado  
Spoodle® perforé ovale



REF		L cm	ml	
6422220	Black	33	59	12
6422335	Orange	34	88	12
6422655	Teal	36	177	12
6422865	Orange	37	236	12

**6432 Perforated round Spoodle®**  
Spoodle® redondo perforado  
Spoodle® perforé ronde



REF		Ø cm	L cm	ml	
6432120	Black	5,2	31	29	12
6432220	Black	6,5	32	59	12
6432230	Blue	6,5	32	59	12
6432335	Orange	7,4	33	88	12
6432420	Black	8,2	34	118	12
6432445	Grey	8,2	34	118	12

# 5.1 Kitchen utensils

Utensilios de cocina  
Ustensiles de cuisine

**47390** Squeeze disher  
Porcionador apretable  
Cuillère-pression de service



REF	Color	Size / Tamaño	Ø cm	ml	12	NEW
47370	○	6	7,6	138	12	NEW
47390	○	6	7,3	139	12	
47371	○	8	7,3	109	12	NEW
47391	●	8	7,3	110	12	
47372	●	10	7,0	95	12	NEW
47392	●	10	7,0	96	12	
47393	●	12	6,4	84	12	
47394	●	14	6,0	71	12	NEW
47395	●	16	5,7	59	12	
47396	●	20	5,2	53	12	
47397	●	24	4,8	45	12	
47398	●	30	4,4	33	12	
47399	●	36	4,4	28	12	
47400	●	40	4,1	21	12	NEW
47401	●	50	3,8	19	12	NEW
47402	●	60	3,5	16	12	NEW
47403	●	70	3,2	14	12	
47404	●	100	2,9	10	12	NEW

**47139** Thumb disher  
Porcionador  
Cuillère de service



REF	Color	Size / Tamaño	Ø cm	ml	12
47139	○	6	7,6	158	12
47140	●	8	7,3	118	12
47141	●	10	7,0	96	12
47142	●	12	6,4	79	12
47143	●	16	5,7	59	12
47144	●	20	5,2	48	12
47145	●	24	4,8	39	12
47146	●	30	4,4	30	12

# Kitchen utensils 5.1

Utensilios de cocina  
Ustensiles de cuisine

**5283520** Round black Spoodle  
Spoodle redondo negro  
Spoodle round noir



REF	Ø cm	L cm	ml	12
5283520	7,1	30,7	88	12
5283720	8,4	31,4	118	12
5283920	9,1	31,9	177	12

**5283620** Perforated black round Spoodle  
Spoodle redondo perforado negro  
Spoodle rond perforé noir



REF	Ø cm	L cm	ml	12
5283620	7,1	30,7	88	12

**5292620** Black oval Spoodle  
Spoodle ovalado negro  
Spoodle ovale noir



REF	L cm	ml	12
5292620	7,6	30,7	12

**5284220** Nylon spoon  
Cuchara nylon  
Cuillère nylon



REF	Color	L cm	12
5284220	■	34	12
5284320	■	34	12

**4689760** Nylon spoon for preparation  
Cuchara nylon para preparación  
Cuillère nylon pour préparation



+ 205°C

REF	Color	L cm	12
4689760	■	21,6	12
4689815	■	30,5	12
4689830	■	30,5	12
4689840	■	30,5	12
4689850	■	30,5	12
4689860	■	30,5	12
4689960	■	38,1	12

See products on / Ver productos en / Voir produits en page

P. 322



Ice-cream and beverage solutions  
Soluciones para la heladería  
Solutions pour glaciers



18/10  
Stainless  
steel

# Kitchen utensils 5.1

Utensilios de cocina  
Ustensiles de cuisine



**Plating tongs for careful lifting, turning and decorating**  
*Pinzas ideales para emplatar y decorar*  
*Pinces idéales pour la présentation et la décoration*

**P3434** Extra long fine tip straight tweezer (narrow)  
*Pinza chef precisión extra larga (fina)*  
*Pince du chef précision extra long (étroite)*



REF	L cm	
P343400	30	72

**P3436** Fine tip straight tweezer  
*Pinza chef precisión*  
*Pince du chef précision*

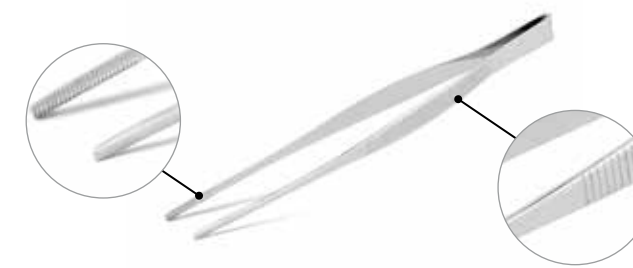

REF	L cm	
P343600	21	288

**P3437** Small fine tip straight tweezer  
*Pinza Chef precisión pequeña*  
*Pince du chef précision petite*

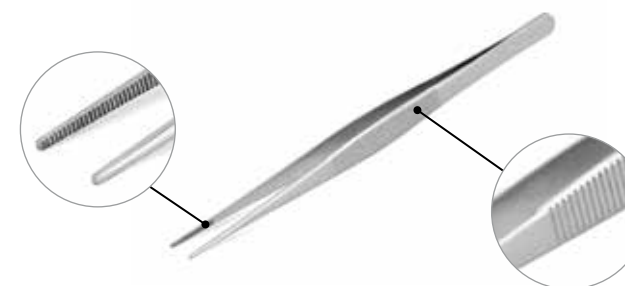

REF	L cm	
P343700	16	288

**P3438** Sushi tweezer  
*Pinza sushi*  
*Pince à sushi*



REF	L cm	
P343800	16	288

See products on / Ver productos en / Voir produits en page

P. 167

**Ice cream cake ring**  
*Aro redondo para tarta*  
*Cercle à vacherin*



# 5.1 Kitchen utensils

Utensilios de cocina  
Ustensiles de cuisine



## P358 INOX Utility tong

Pinza buffet  
Pince buffet



REF	L cm	📦
P358024	24	72
P358029	30	72
P358040	40	72

## 473 Heavy duty utility tongs

Pinzas inox servicio pesado  
Pincas inox service lourd



**NEW!**

REF	L cm	📦
47309	24	12
47312	30	12
47316	40	12

## P358 COLOR Utility tong coloured handle

Pinza buffet inox mango color  
Pince buffet inox manche couleur



Made of one piece St/Steel. Handle with PVC coating for a better grip and insulation.

Fabricadas en acero inoxidable monobloc. Mango con revestimiento PVC aislante para una mejor sujeción.

Fabriquées en acier inoxydable monobloc. Manche avec revêtement PVC pour une meilleure préhension et isolation.

Ref : P358 + L + Colour / Color / Couleur

Ref	L cm	White Blanco Blanc	Red Rojo Rouge	Blue Azul Bleu	Yellow Amarillo Jaune	Green Verde Vert	Brown Marrón Marron	Black Negro Noir	📦
P358	24	1	2	3	4	5	6	7	120
P358	30	1	2	3	4	5	6	7	120
P358	40	-	-	-	4	-	-	7	120

# Kitchen utensils 5.1

Utensilios de cocina  
Ustensiles de cuisine



Made of a single piece of stainless steel, in a W form to ensure maximum resistance and durability.

Fabricadas en acero inox, de una sola pieza, en forma de W que aseguran una máxima resistencia y durabilidad.

Fabriquées en acier inox, en une seule pièce, en forme de W, garantissant une résistance et une durabilité maximums.



## 4780920 One-Piece utility tong Kool-Touch®

Pinza buffet monobloc Kool-Touch®  
Pince buffet Kool-Touch®

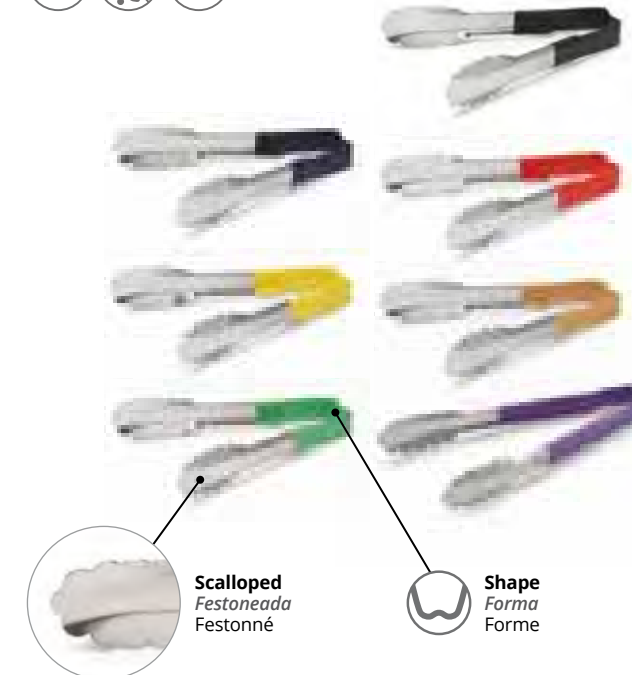

REF	Color	L cm	📦
4780920	Black	24	12
4781220	Black	30	12
4781620	Black	40	12
4780930	Blue	24	12
4781230	Blue	30	12
4781630	Blue	40	12
4780940	Red	24	12
4781240	Red	30	12
4781640	Red	40	12
4780950	Yellow	24	12
4781250	Yellow	30	12
4781650	Yellow	40	12
4780960	Orange	24	12
4781260	Orange	30	12
4781660	Orange	40	12
4780970	Green	24	12
4781270	Green	30	12
4781670	Green	40	12
4780980	Purple	24	12 <b>NEW</b>
4781280	Purple	30	12 <b>NEW</b>

## 4780620 One-Piece tong Kool-Touch®

Pinza buffet monobloc Kool-Touch®  
Pince buffet inox Kool-Touch®

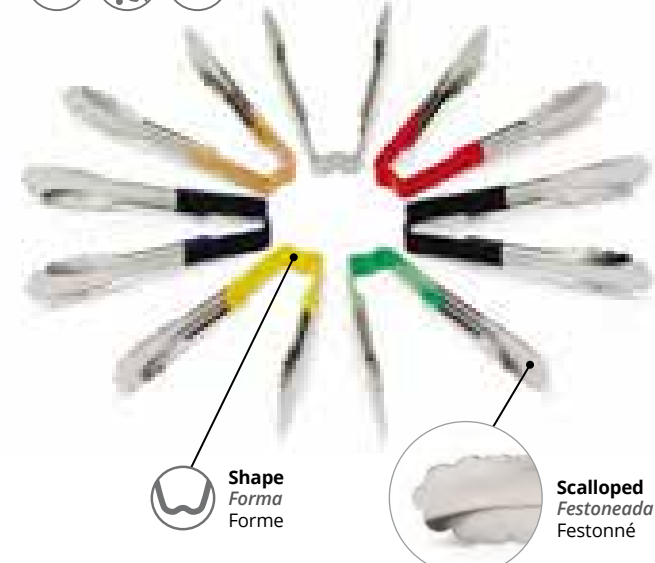

Shorter utility tong for tight spaces or delicate food applications

Pinza más corta para espacios estrechos o comida delicada

Pince utilitaire courte pour espaces restreints ou aliments délicats à manipuler

REF	Color	L cm	📦
4780620	Black	15	12
4780630	Blue	15	12
4780640	Red	15	12
4780650	Yellow	15	12
4780660	Orange	15	12
4780670	Green	15	12



# 5.1 Kitchen utensils

Utensilios de cocina  
Ustensiles de cuisine

**4780610** Stainless steel tong  
Pinza de acero inoxidable  
Pince inoxydable

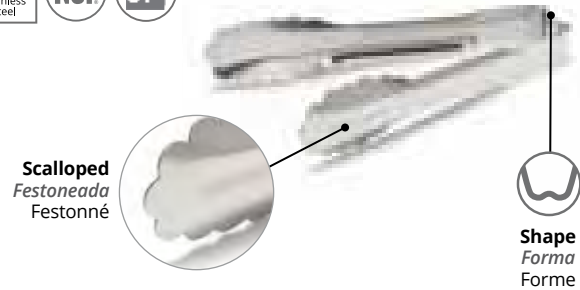

\* Shorter utility tong for tight spaces or delicate food applications  
\* Pinza más corta para espacios estrechos o comida delicada  
\* Pince utilitaire courte pour espaces restreints ou aliments délicats a manipuler

REF	L cm	
4780610*	15,2	12
4780910	24,1	12
4781210	30,5	12
4781610	40,6	12

**4780912** Utility tong with nylon end  
Pinza con extremo de nylon  
Pince utilitaire avec extrémité nylon

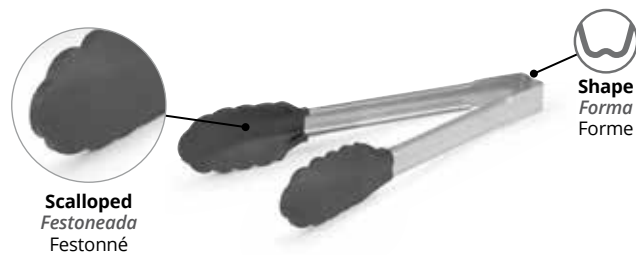

REF	L cm	
4780912	24	12
4781212	30	12
4781612	40	12

**4791210** VERSAGRIP® Stainless steel tong  
Pinza VERSAGRIP® de acero inoxidable  
Pince inox VERSAGRIP®

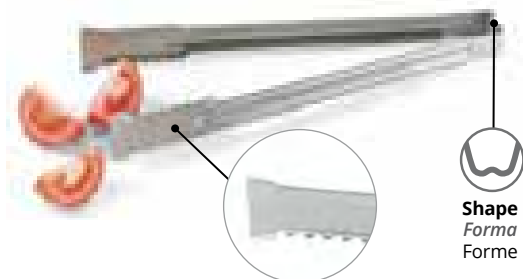

**4781622** Utility tong with nylon end  
Pinza con extremo de nylon  
Pince utilitaire avec extrémité nylon



REF	L cm	
4781622	40	12
4780922	24	12
4781222	30	12

**47326** Kool-Touch® Reinforced Pom Tong  
Pinza dentada reforzada Kool-Touch®  
Pince ceinture renforcée Kool-Touch®



Ideal for ovens, grills and barbecues  
Ideal para hornos, brasa y barbacoa  
Idéal pour fours, grill et barbecue

REF	L cm	
47326	15,2	12
47322	30,0	12

REF	L cm	
4790910	24,0	12 NEW
4791210	30,5	12
4791610	40,6	12

VERSAGRIP®  
Features flattened ends and gripper teeth.  
Presenta extremos aplanados y dentados para mayor agarre.  
Offre des extrémités aplaties et crantées pour une meilleure prise.

# Kitchen utensils 5.1

Utensilios de cocina  
Ustensiles de cuisine

**47046** Reinforced Pom Tong  
Pinza dentada reforzada  
Pince ceinture renforcée



Ideal for ovens, grills and barbecues  
Ideal para hornos, brasa y barbacoa  
Idéal pour fours, grill et barbecue

REF	L cm	
47046	15,2	36
47049	22,9	24

**P611** Pom tong  
Pinza dentada  
Pince ceinture



Ideal for ovens, grills and barbecues  
Ideal para hornos, brasa y barbacoa  
Idéal pour fours, grill et barbecue

REF	L cm	
P611001	24	288

**P620** Chip bagger  
Pala chips  
Pelle à frites



Right hand  
Mano derecha  
Main droite

REF	cm	
P620001	23 x 21	1

**P621** ABS chip bagger  
Pala chips ABS  
Pelle à frites en ABS



+ 80 °C



REF	cm	
P621000	23 x 21	36

**47325** Heavy-Duty scissor tongs  
Pinza tipo tijeras de uso intensivo  
Pincas type ciseaux à usage intensif

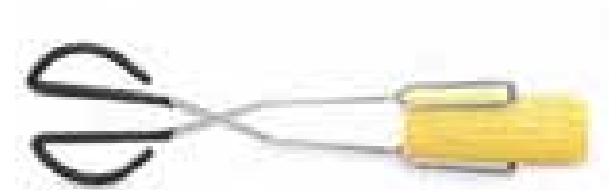

REF	Color	L cm	
47325		38	12

# 5.1 Kitchen utensils

Utensilios de cocina  
Ustensiles de cuisine

**4808820 Solid Turner**  
Espátula reforzada  
Palette renforcée



Heavy duty  
Extra resistente  
Extra résistant



REF	Color	cm	L cm	
4808820		21 x 7,5	42	12

**4808920 Perforated Turner with**  
Espátula perforada reforzada  
Palette perforée renforcée



REF	Color	cm	L cm	
4808920		21 x 7,5	42	12

**5284120 Slotted reinforced nylon turner**  
Espátula nylon reforzada  
Spatule renforcée à nylon



One-piece construction  
Construcción de una sola pieza  
Construction monobloc

Heavy duty  
Extra resistente  
Extra résistant



REF	Color	L cm	
5284120		34,5	12

**P385 Baker spatula**  
Espátula pastelera  
Palette



ABS Handle  
Mango ABS  
Man



REF	Peel / Pala / Pelle cm	L cm	
P385020	20,5	34,0	72
P385026	26	39,0	72
P385030	30	43,5	72

**P381 Cleaning spatula**  
Espátula triangular "pintor"  
Palette triangle



ABS Handle  
Mango ABS  
Manche en ABS



REF	cm	L cm	
P381008	8	24,5	120
P381010	10	25,0	120

# Kitchen utensils 5.1

Utensilios de cocina  
Ustensiles de cuisine

**P382 Spatula**  
Pala bar  
Palette



ABS Handle  
Mango ABS  
Manche en ABS



REF	cm	L cm	
P382000	7 x 16	29	144

**P383 Fast-food and fish turner**  
Pala fast-food y pescado  
Palette fast-food et poisson



ABS Handle  
Mango ABS  
Manche en ABS

Flexibel  
Flexible



REF	cm	L cm	
P383000	7,3 x 25	38	144

**P384 Perforated fast-food turner**  
Pala fast-food perforada  
Palette fast-food perforée



ABS Handle  
Mango ABS  
Manche en ABS

Flexibel  
Flexible



REF	cm	L cm	
P384000	7,3 x 25	38	144

**P386 Dough scraper**  
Rasqueta  
Raclette



ABS Handle  
Mango ABS  
Manche en ABS



REF	cm	
P386000	15 x 7,5	144

**P380 Pizza wheel**  
Ruleta cortapizzas  
Roulette à pizza



ABS Handle  
Mango ABS  
Manche en ABS



REF	cm	L cm	
P380000	10	23,5	12

# 5.1 Kitchen utensils

Utensilios de cocina  
Ustensiles de cuisine

**P3855 Butter spreader**  
Espátula para untar  
Couteau à beurre



REF	Peel / Pala / Pelle cm	L cm	
P385500	10,4 x 3,4	23	144

**P872 Cake server**  
Pala pasteles  
Pelle à gâteau



Without saw  
Sin sierra  
Sans scie

REF	L cm	
P872000	28	144

**P37501 Triangle dough scraper. Wood handle**  
Rasqueta triangular. Mango madera  
Raclette triangle. Manche en bois



REF	Peel / Pala / Pelle cm	L cm	
P375010	10,2 x 10	21	144

**P37506 Spatula. Wood handle**  
Pala bar. Mango madera  
Palette. Manche en bois



REF	Peel / Pala / Pelle cm	L cm	
P375061	15,2 x 7,6	29	144

**P37507 Rectangular dough scraper. Wood handle**  
Rasqueta rectangular. Mango madera  
Raclette rectang. Manche en bois



REF	Peel / Pala / Pelle cm	L cm	
P375070	15,2 x 7,6	11,3	144

**P37511 Butter spreader. Wood handle**  
Espátula para untar. Mango madera  
Couteau à beurre. Manche en bois



REF	Peel / Pala / Pelle cm	L cm	
P375110	10,2 x 3,3	19,7	144

# Kitchen utensils 5.1

Utensilios de cocina  
Ustensiles de cuisine

**P374 St/Steel double mesh strainer**  
Colador doble malla en acero inoxidable  
Passoire double maille en acier inox

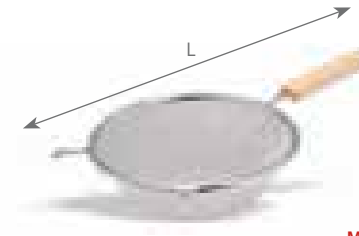

REF	Ø cm	L cm	Mesh size Luz de malla Maillage mm	
P374013	13	30,0	1-3	72
P374015	15	32,0	1-3	72
P374018	18	34,0	1-3	72
P374020	20	38,0	1-3	72
P374026	26	58,5	1,6-3	72

**P324 St/Steel reinforced 1/2 ball colander**  
Colador 1/2 bola reforzado en acero inox  
Passoire ronde renforcé en acier inox

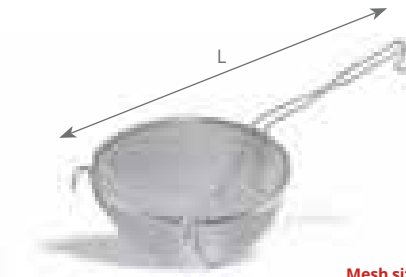

REF	Ø cm	L cm	Mesh size Luz de malla Maillage mm	
P324013	13	36,0	0,530	36
P324016	16	40,0	0,530	36
P324019	19	42,5	0,530	36
P324022	22	49,0	0,530	36
P324025	25	55,5	0,530	36

**P325 St/Steel hemispherical strainer**  
Colador media bola en acero inox  
Passoire demi-sphérique en acier inox



REF	Ø cm	L cm	Mesh size Luz de malla Maillage mm	
P325008	8	22,5	0,700	96
P325010	10	25,2	0,700	96
P325012	12	32,5	0,700	96
P325015	15	40,2	0,700	72
P325018	18	42,5	0,700	72
P325020	20	44,5	0,700	72

**P375 St/Steel double mesh strainer. Reinforced**  
Colador doble malla en acero inoxidable. Reforzado  
Passoire double maille en acier inox. Renforcé

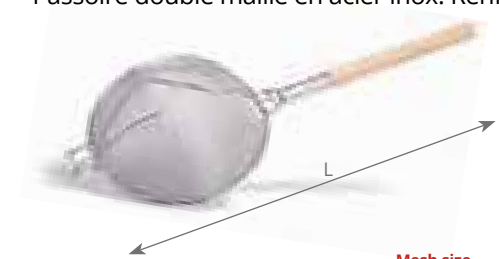

REF	Ø cm	L cm	Mesh size Luz de malla Maillage mm	
P375030	30	79,0	1,040	12
P375035	35	86,5	1,040	12

**P348 St/Steel conical strainer**  
Colador cónico en acero inoxidable  
Passoire conique en acier inox

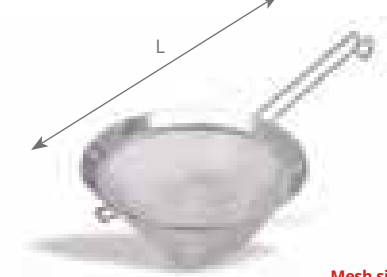

REF	Ø cm	L cm	Mesh size Luz de malla Maillage mm	
P348008	8	22,5	0,700	96
P348010	10	24,5	0,700	96
P348012	12	31,5	0,700	96
P348015	15	35,0	0,700	96
P348018	18	40,5	0,700	72

**P373 Cotton strainer**  
Colador bayeta  
Passe-bouillon



REF	L cm	
P373020	21,5	1
P373024	26,0	1
P373028	29,0	1

# 5.1 Kitchen utensils

Utensilios de cocina  
Ustensiles de cuisine



**P303** Conical colander  
Colador chino  
Chinois



REF	Ø cm	H cm	
P303016	17,2	15,9	24
P303018	18,6	17,9	24
P303020	21,1	20,6	24
P303022	23,2	23,0	24
P303024	25,1	25,2	24
P303026	27,2	28,1	24

**P347** Conical colander with wire gauze  
Colador chino con malla  
Chinois à gaze



REF	Ø cm	Mesh size Luz de malla Maillage mm	
P347020	20	0,700	12
P347024	24	0,700	12

**P970** Stand for chinese colander or funnel  
Soporte para chino o embudo  
Support pour chinois ou entonnoir



REF	Ø cm	H cm	
P970000	16	19	18

**P3032** Triangle  
Triángulo  
Triangle



Equilateral triangle  
Triángulo equilátero  
Triangle équilatéral

REF	L cm	
P303200	29	24

See products on / Ver productos en / Voir produits en page

P. 162

**Confectionery funnel**  
Embudo dosificador  
Entonnoir doseur



# Kitchen utensils 5.1

Utensilios de cocina  
Ustensiles de cuisine

**P308** Conical colander  
Escurridera  
Passoire conique



Heavy duty  
Extra resistente  
Extra résistant



REF	Ø cm	H cm	
P308030	30	16,0	1
P308035	35	16,5	1
P308040	40	18,0	1
P308045	45	19,5	1
P308050	50	22,5	1

**P109** Conical colander  
Escurridera con aro  
Passoire conique



REF	Ø cm	H cm	
P109035	35	16,5	1
P109040	40	17,5	1
P109045	45	20,0	1
P109050	50	22,5	1

**P300** St/steel colander with stand  
Escurridera inox con base  
Passoire inox sur pied



REF	Ø cm	H cm	
P300024	24	11,50	48
P300030	30	13,50	24

**P3003** Mesh conical colander  
Escurridera de malla  
Passoire à maille



REF	Ø cm	H cm	
P300325	25	12	1
P300335	35	18	6
P300340	40	18	6

## 5.1 Kitchen utensils

Utensilios de cocina  
Ustensiles de cuisine

SS  
Stainless  
steel

### P313 Vegetable sieve Pasapurés Moulin à légumes



With 2 St/Steel interchangeable cutters  
Con 2 discos inox. intercambiables  
Avec 2 coupeurs inox interchangeables

REF	Ø cm	Ø cm Filter / Filtro / Filtre	
P313025	25	11,5	1
P313030	30	14,5	16

### P945 Flour bin Harinero Tamis à farine



REF	W x D x H cm	
P945037	37 x 26,5 x 18	4
P945050	50 x 26,5 x 18	3
P945051	50 x 33 x 18	1

### P958 St/Steel hook 1p. Gancho acero inoxidable 1p. Crochet inox 1p.



REF	L cm	Ø mm	
P958010	10	4	20
P958012	12	5	20
P958014	14	6	20
P958016	16	6	20
P958018	18	6	20

### P3131 Vegetable sieve Pasapurés Moulin à légumes



With 2 St/Steel interchangeable cutters  
Con 2 discos inox. intercambiables  
Avec 2 coupeurs inox interchangeables

REF	Ø cm	Ø cm Filter / Filtro / Filtre	
P313126	26	16,5	1
P313132	32	16,5	1

### P954 Funnel with removable filter Embudo con filtro extraíble Entonnoir avec filtre extractible



REF	Ø A cm	Ø B cm	
P954013	13	2,6	30
P954015	15	2,6	20
P954020	20	3,2	20
P954025	25	3,2	8

Products made of optimal quality stainless steel.  
Precision and easy handling.

Productos fabricados en acero inoxidable de óptima calidad. Precisión y fácil manejo.

Produits en acier inoxydable de qualité. Précision et manipulation facile.

## Kitchen utensils 5.1

Utensilios de cocina  
Ustensiles de cuisine



### P870 Round egg ring Molde huevo sandwich redondo Moule à oeuf rond

SS  
Stainless  
steel



REF	Ø cm	H cm	
P870000	8,5	11,0	300

### P871 Squared egg mould Molde huevo sandwich cuadrado Moule à oeuf carré

SS  
Stainless  
steel



REF	W x D x H cm	
P871000	8,5 x 8,5 x 11	300

### P905 Solid St/Steel meat beater Aplastacarnes inox forjado Aplatisseur inox forgé

SS  
Stainless  
steel



REF	Ø cm	Kg	L cm	
P905015	10	1,5	14	10

### P942 / P943 Meat tenderizer Aplastadora carne Aplatisseur à viande

SS  
Stainless  
steel



REF	Ø cm	Kg	L cm	
P942000	9,5	0,750	28,5	20
P943000	9,5	0,750	28,5	20

# Graters selection guide

## Guía selección ralladores

### Guide sélection râpes

	RIBON DOBLE NAVAJA TRANCHANTS	LARGE SHAVER TIRAS LARGAS LARGE COUPE	FINE FINO FIN	MEDIUM MEDIO MOYEN	EXTRA COARSE GRUESO GROS GRAINS	DUAL DUAL DOUBLE
<b>Carrot</b> Zanahoria Carotte	✓	✓				✓
<b>Onion</b> Cebolla Oignon	✓			✓		✓
<b>Garlic</b> Ajo Ail			✓			
<b>Chocolate</b>	✓		✓	✓	✓	✓
<b>Citrus</b> Cítricos Citron		✓	✓	✓		
<b>Potato</b> Patata Pomme de Terre	✓	✓				
<b>Apple</b> Manzana Pomme	✓	✓			✓	
<b>Hard Cheese</b> Queso duro Fromage	✓		✓	✓	✓	✓
<b>Soft Cheese</b> Queso blando Fromage	✓				✓	
<b>Nut</b> Nuez Noix			✓	✓		✓
<b>Pepper</b> Pimiento Poivron			✓	✓		✓
<b>Tomato</b> Tomate Tomato				✓	✓	

### P328 Grater

#### Rallador

#### Râpe



P328600

REF	Sides / Caras / Faces	W x D x H cm	
P328020	4	9 x 6,5 x 20,8	144
P328023	4	10,5 x 8 x 23,3	72
P328600	6	14,5 x 11 x 22	72

### P391 St/Steel nutmeg grater

#### Rallador nuez moscada de acero inox

#### Râpe à muscade en acier inox



REF	
P391000	50

# Kitchen utensils 5.1

Utensilios de cocina  
Ustensiles de cuisine



### P3221 St/Steel "slim" grater with handle

#### Rallador acero inoxidable "slim" con mango

#### Râpe inoxydable "slim" avec queue



**IDEA!** Ideal for citrus  
Especial cítricos  
Idéal pour agrumes



P322104  
**Fine**  
Fino  
Fin



P322103  
**Medium**  
Medio  
Moyen



P322101  
**Dual**  
Dual  
Double



P322102  
**Ribon**  
Doble navaja  
Tranchants

REF	cm	
P322101	39,5 x 3,5	48
P322102	39,5 x 3,5	48
P322103	39,5 x 3,5	48
P322104	39,5 x 3,5	48

Ergonomic and soft touch handles. Non-slip rubber end / Mangos ergonómicos. Borde antideslizante / Poignée ergonomique. Extrémité anti-dérapant

### P3222 St/Steel "wide" grater with handle

#### Rallador acero inoxidable "wide" con mango

#### Râpe inoxydable "wide" avec queue



**IDEA!** Ideal for citrus  
Especial cítricos  
Idéal pour agrumes



P322204  
**Fine**  
Fino  
Fin



P322202  
**Ribon**  
Doble navaja  
Tranchants



P322201  
**Large shaver**  
Tiras largas  
Large coupe



P322203  
**Extra coarse**  
Grueso  
Gros grains

REF	cm	
P322201	31,5 x 7,3	48
P322202	31,5 x 7,3	48
P322203	31,5 x 7,3	48
P322204	31,5 x 7,3	48

# 5.1 Kitchen utensils

Utensilios de cocina  
Ustensiles de cuisine

## P868 Squeeze dispenser Dispensador a presión Distributeur à pression



\* Clear  
Transparente  
Transparent

REF	Color	ml	H cm	Ø cm	Box
P868001	Red	240	18,0	5	108
P868002	Red	360	21,0	5	72
P868003	Red	720	24,5	5	36
P868004	Yellow	240	18,0	5	108
P868005	Yellow	360	21,0	5	72
P868006	Yellow	720	24,5	5	36
P868007*	Clear	240	18,0	5	108
P868008*	Clear	360	21,0	5	72
P868009*	Clear	720	24,5	5	36

## 2808-13 Squeeze dispenser Dispensador a presión Distributeur à pression



Clear  
Transparente  
Transparent



Ref	Color	ml	H cm	Ø cm	Box
2808-13	Clear	240	18,4	5,0	12
2812-13	Clear	350	18,4	6,0	12
4916-13	Clear	470	18,7	7,5	12
4924-13	Clear	710	26,0	7,3	12
4932-13	Clear	950	26,4	8,3	12

**IDEAL!** Ideal for dish presentation  
Ideal para decoración  
Idéal pour decoration

## 2208-13TT Twin squeeze dispenser Dispensador a presión doble Distributeur à pression double



Clear  
Transparente  
Transparent

REF	Color	Lts	H cm	Ø cm	Box
2208-13TT	clear select*	0,24	18,4	5,1	12
2212-13TT	clear select*	0,35	18,4	6,0	12
2224-13TT	clear select*	0,71	24,8	7,5	12

## 3316-13TT Tri squeeze dispenser Dispensador a presión triple Distributeur à pression triple



Clear  
Transparente  
Transparent

REF	Color	Lts	H cm	Ø cm	Box	
3316-13TT	clear select*	0,47	18,7	7,5	12	
3324-13TT	clear select*	0,71	24,8	7,5	12	
3324C-BBTT	select**	select*	0,71	24,8	7,5	12
3332-13TT	clear select*	0,95	25,4	8,6	12	

\* Select top colors

\* Selección los colores de la parte superior

\* Sélectionnez les couleurs de bouchon

01	44
02	54
08	191
13	

\*\* Select bottle color

\*\* Seleccione el color de la botella

\*\* Sélectionnez la couleur de la bouteille

01	44
02	54
08	191
13	

## 2200-777 Replacement caps for dispensers Recambio de boquillas Bouchons de rechange pour distributeurs



REF	Color	For Para Pour	Box
2200-777	select*	2208-13TT / 2212-13TT / 2224-13TT	12
3300-TT	select*	3316-13TT / 3324-13TT / 3324C-BBTT / 3332-13TT	12

# Kitchen utensils 5.1

Utensilios de cocina  
Ustensiles de cuisine

## 2908 Squeeze dispenser with open-close system cap Dispensador a presión con tapón cierre rosca Distributeur pressurisation a/capuchon d'ouverture-fermeture



Clear  
Transparente  
Transparent



REF	ml	H cm	Ø cm	Box
2908-13	240	18,4	5,1	12
2912-13	350	18,4	6,0	12
5324-13	710	24,4	7,3	12

## 26120 Squeeze dispenser with cap Dispensador a presión con tapón Distributeur pression avec capuchon



Clear  
Transparente  
Transparent



REF	ml	H cm	Ø cm	Box
26120-13	350	16,2	6,2	12
26240-13	710	22,5	7,5	12
26320-13	950	22,9	8,6	12

## 4961 Dredgers Especieros Saupoudreuses



Clear  
Transparente  
Transparent



REF	ml	Ø cm Holes / Agujeros / Troues	Ø cm	H cm	Box
4961-13191	470	0,14	7,3	16	12
4961-1332	470	0,25	7,3	16	12
4961-1308	470	0,46	7,3	16	12
4961-1301	470	0,94	7,3	16	12

## P946 Dredgers Especieros Saupoudreuses

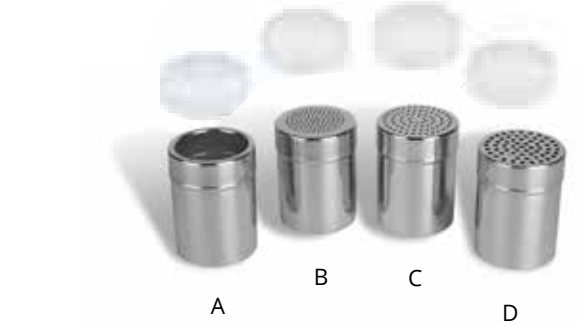

Dredger "A" with mesh  
Especiero "A" con malla  
Saupoudreuse "A" maillée

With plastic cover  
Con tapón de plástico  
Avec couvercle en plastique

REF	Ø cm Holes / Agujeros / Troues	H cm	Ø cm	Box
A P946001	-	9,6	7	144
B P946002	0,2	9,6	7	144
C P946003	0,3	9,6	7	144
D P946004	0,4	9,6	7	144

## 5.1 Kitchen utensils

Utensilios de cocina  
Ustensiles de cuisine

**P334** Oil pourer  
Alcuza  
Huilière



REF	Lts	
P334050	0,50	20
P334100	1,00	20

**P873** Aluminium check minder  
Barra de notas de aluminio  
Barre porte-bons en aluminium



REF	L cm	H cm	
P873045	45	5,0	48
P873060	60	5,0	48
P873090	90	5,0	48

**P8180** Metallic brush  
Cepillo metálico  
Brosse métallique



**Ideal for ovens, grills and barbecues**  
Ideal para hornos, brasa y barbacoa  
Idéal pour fours, grill et barbecue

REF	L cm	
P818000	27	1

**P94009** St/Steel mixing paddle  
Remo acero inoxidable  
Spatule géante inoxydable



REF	Peel / Pala / Pelle cm	L cm	
P940090	12 x 19	90	12
P940120	12 x 19,5	120	12

**P940** Grill scraper aluminium  
Rascador con mango aluminio  
Raclette à plancha



REF	cm	
P940000	44,5 x 12 x 12,7	6
RE940001	12,7 x 7,7	24

**P944** Fish scaler  
Escamador  
Ecailleur



REF	L cm	
P944000	23,5	1

REDCO® pujadas®  
A VOLLRATH COMPANY

### WIDE RANGE OF MANUAL FOOD PROCESSORS

Cuts both fruit and vegetables  
Speed up your work 11 times faster than hand cutting  
Easy-to-remove interchangeable blades  
Easy to clean

### AMPLIA GAMA DE PROCESADORES DE ALIMENTOS MANUALES

Corta verduras y frutas  
Hasta 11 veces más rápido que el corte a mano  
Fácil intercambio de las cuchillas  
Limpieza rápida y fácil

### LARGE GAMME D'APPAREILS MANUELS DE TRANSFORMATION DES ALIMENTS

Coupe les légumes et les fruits  
Jusqu'à 11 fois plus rapide que lorsque vous coupez à la main  
Couteaux facilement interchangeables  
Nettoyage rapide et facile



DICE & STICKS  
DADOS Y BASTONCILLOS  
CUBES ET BÂTONNETS



SLICE  
REBANADA  
TRANCHES



WEDGE  
GAJOS  
QUARTIERS



CORE  
SACACORAZONES  
ÉVIDOIR





# Which manual food processors do you need?

¿Qué procesador manual de alimentos necesitas?

Quel appareil manuel de transformation des aliments vous faut-il ?

**TIME SAVING**  
Faster than cutting by hand.  
**AHORRO TIEMPO**  
Veces más rápido que cortar a mano.  
**GAIN DE TEMPS**  
Fois plus rapide qu'une coupe à la main.



**3x**



**3x**



**5x**

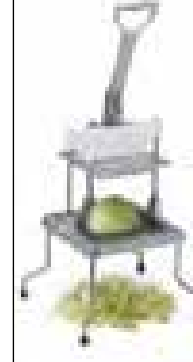

**11x**

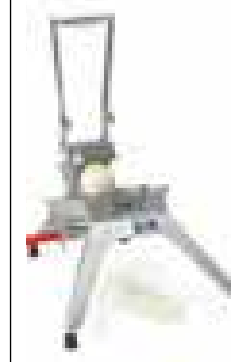

**2,5x**

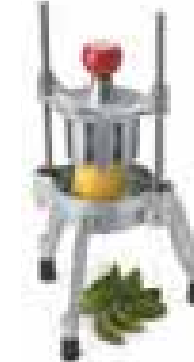

**3x**



**3x**



**5x**

-  **Lemons**  
Limonas  
Citrons
-  **Limes**  
Limas  
Citrons verts
-  **Oranges**  
Naranjas  
Oranges
-  **Tomatoes**  
Tomates  
Tomates
-  **Onions**  
Cebollas  
Oignons
-  **Celery**  
Apio  
Céleri
-  **Peppers**  
Pimientos  
Poivrons
-  **Potatoes**  
Patatas  
Pommes de terre
-  **Apples**  
Manzanas  
Pommes
-  **Pears**  
Peras  
Poires
-  **Lettuce**  
Lechuga  
Laitue
-  **Bell peppers**  
Pimientos  
Poivrons
-  **Cucumbers**  
Pepino  
Concombres

- ✓
- ✓
- ✓
- ✓
- ✓
- ✓
- ✓
- ✓
- ✓ 4x
- ✓ 4x
- 
- ✓

- ✓
- ✓
- ✓
- ✓
- ✓
- ✓
- ✓
- ✓
- ✓ 4x
- ✓ 4x
- 
- 

- 
- ✓
- 
- 
- 
- 
- 
- 
- 
- 
- 
- ✓
- ✓
- ✓

- ✓
- ✓
- ✓
- 
- ✓
- 
- 
- 
- 
- 
- 
- 
- 

- ✓
- ✓
- ✓
- ✓
- ✓
- ✓
- ✓
- ✓
- ✓
- ✓
- 
- 

- ✓
- ✓
- ✓
- ✓
- ✓
- ✓
- ✓
- ✓
- ✓
- ✓
- 
- 

- ✓



SS  
Stainless  
steel

Al  
Aluminium

# Manual food processors 5.2

Procesadores manuales de alimentos  
Appareils manuels de transformation des aliments

## 55457 Big size tabletop dicer & slicer Cortador-Rebanador de sobremesa grande Grand Coupe légumes en tranches et cubes



**InstaCut™ 5.0**  
Tabletop  
Sobremesa  
À poser

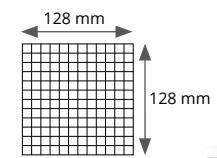

Adjustable to  
Adaptable a  
Adaptable à

Inside / Dentro / Dans  
1/3 100 mm  
1/4 150 mm  
1/6 150 mm

Outside / Fuera /  
Extérieur (max)  
1/1 200 mm



With suction base.  
Con ventosas de agarre en la base.  
Avec ventouse d'accrochement à la base.

REF	Type / Tipo	Cut / Corte / Coupe mm	
<b>DICE &amp; STICKS / DADOS - BASTONCILLOS / CUBES ET BÂTONNETS</b>			
55457		6,4 ●	1
55458		9,5	1
55459		12,7	1
<b>SLICE / REBANADA / TRANCHES</b>			
55460		6,4 ●	1

Items marked with the same coloured dot are compatible with each other  
Los artículos marcados con cada punto de color son compatibles entre ellos  
Les articles marqués d'un point de couleur sont compatibles

\*H 50,8 cm Open / Abierto / Ouvert  
\*H 47 cm Closed / Cerrado / Fermé

3X Faster / Más rápido

4X Faster / Más rápido

T-handle, pusher block and blade  
Asa en T, bloque de empuje y cuchilla  
Poignée en T, bloc de poussée et lame

TIPO/TYPE	REF	mm
<b>DICE &amp; STICKS / DADOS - BASTONCILLOS / CUBES ET BÂTONNETS</b>		
	● 55483	6,4
	● 55484	9,5
	● 55485	12,7
<b>SLICE / REBANADA / TRANCHES</b>		
	● 55486	6,4
<b>SECTION / SECCIONES / QUARTIERS</b>		
<b>WEDGE / GAJOS / QUARTIERS</b>		
	● 55490	6
	● 55491	8
	● 55492	10
	● 55493	12
<b>CORE / SACACORAZONES / ÉVIDOIR</b>		
	● 55494	6

Replacement blade only  
Sólo cuchilla de reemplazo  
Lame de rechange seule

REF
● 55470
● 55471
● 55472
● 55473
● 55477
● 55478
● 55479
● 55480
● 55481
● 55482

## 5.2 Manual food processors

Procesadores manuales de alimentos  
Appareils manuels de transformation des aliments



### 15000 Small size tabletop dicer & slicer Cortador-Rebanador de sobremesa pequeño Coupe légumes en tranches et cubes de table

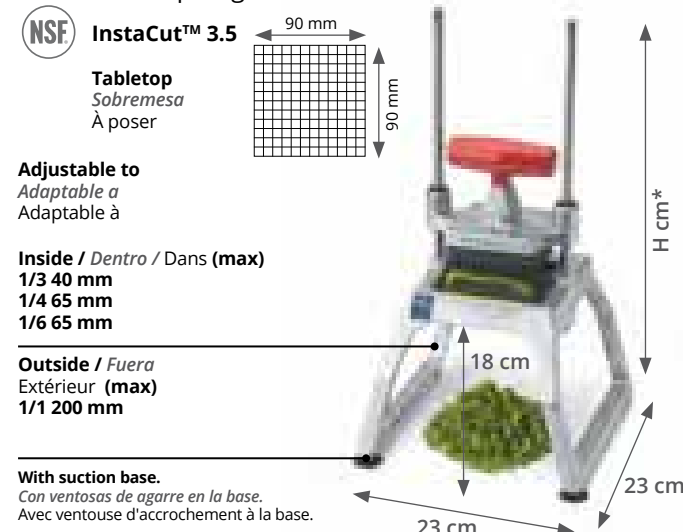

REF	Type / Tipo	Cut / Corte / Coupe mm	
<b>DICE &amp; STICKS / DADOS - BASTONCILLOS / CUBES ET BÂTONNETS</b>			
15000		6,4	1
15001		9,5	1
15002		12,7	1

REF	Type / Tipo	Cut / Corte / Coupe mm	
<b>WEDGE / GAJOS / QUARTIERS</b>			
15005		6	1
15006		8	1
15007		10	1

\*H 45,7 cm Open / Abierto / Ouvert  
\*H 43,5 cm Closed / Cerrado / Fermé

**3X Faster / Más rápido**   
**4X Faster / Más rápido**

### 15016 Wall mount dicer & slicer Cortador-Rebanador de pared Coupe légumes fixation murale

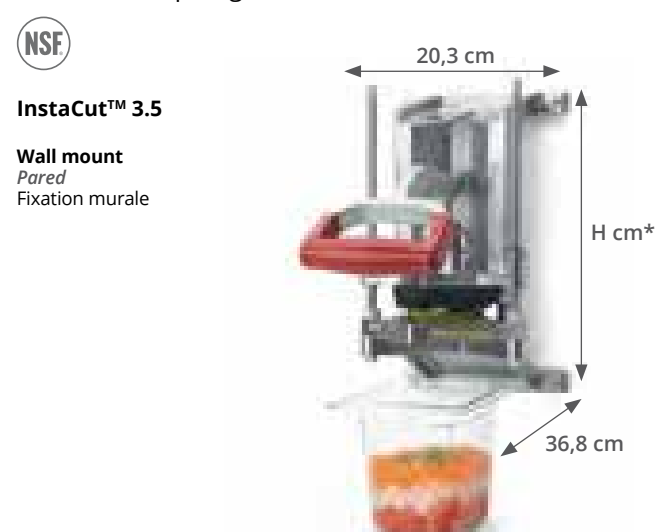

REF	Type / Tipo	Cut / Corte / Coupe mm	
<b>DICE &amp; STICKS / DADOS - BASTONCILLOS / CUBES ET BÂTONNETS</b>			
15016		6,4	1
15017		9,5	1

#### Replacement blade only Sólo cuchilla de reemplazo Lame de rechange seule

REF	
15062	
15063	
15064	
15086	
15065	
15067	
15068	
15069	
15070	
15072	

## Manual food processors 5.2

Procesadores manuales de alimentos  
Appareils manuels de transformation des aliments



### 47713 Potato cutter Cortador de patatas Coupe-pommes de terre

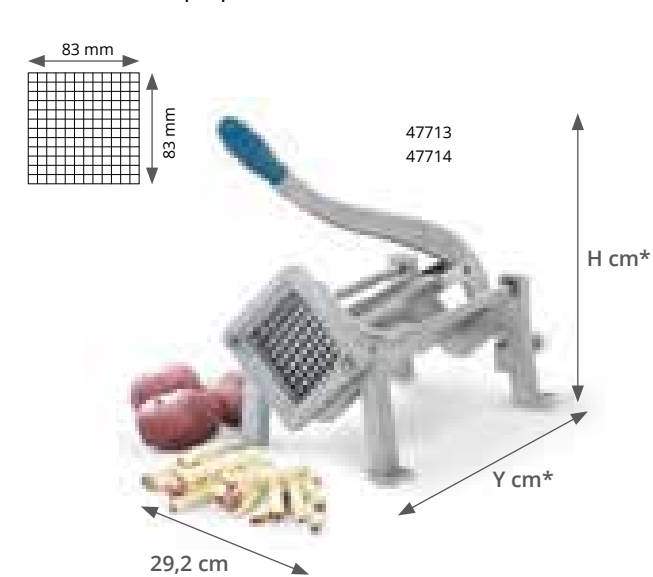

REF	Type / Tipo	Cut / Corte / Coupe mm	
<b>DICE &amp; STICKS / DADOS - BASTONCILLOS / CUBES ET BÂTONNETS</b>			
47713		9,50	1
47714		11,00	1
47715		7,14	1 NEW
47703		8,00	1 NEW

\*Y 87,6 cm H 58,4 cm Open / Abierto / Ouvert  
\*Y 45,0 cm H 35,6 cm Closed / Cerrado / Fermé



#### T-handle, pusher block and blade Asa en T, bloque de empuje y cuchilla Poignée en T, bloc de poussée et lame

REF	Type / Tipo	Cut / Corte / Coupe mm	
<b>DICE &amp; STICKS / DADOS - BASTONCILLOS / CUBES ET BÂTONNETS</b>			
45749-1		9,5	1
45750-1		11,0	1
45751-1		7,0	0

Screw holes on base of legs for permanent mounting to table or wall.  
Agujeros para tornillos en la base de las patas para el montaje permanente en mesas o paredes.  
Trous à vis sur la base des pieds pour fixation permanente sur une table ou un mur.

### P975 French fry cutter Cortador de patatas fritas Coupe frites

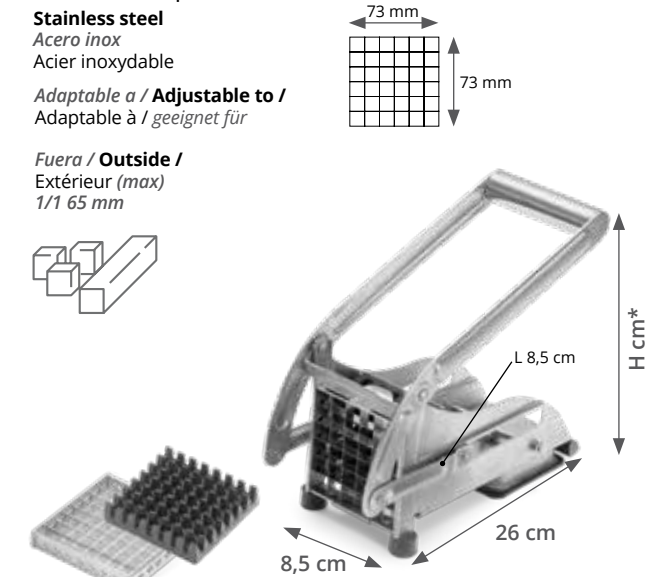

REF	Cut / Corte / Coupe mm	Holes / Agujeros / Trous	
P975000	12 / 9	36 / 64	1

\*H 30 cm Open / Abierto / Ouvert  
\*H 13 cm Closed / Cerrado / Fermé

#### Replacement blade only Sólo cuchilla de reemplazo Lame de rechange seule

REF	Cut / Corte / Coupe mm	Holes / Agujeros / Trous	
RE975001	12	36 (6 x 6)	1
RE975002	9	64 (8 x 8)	1

## 5.2 Manual food processors

Procesadores manuales de alimentos  
Appareils manuels de transformation des aliments



**400N** Salad cutter  
Cortador de lechuga  
Coupe-Salade

LETTUCE  
KING® I



Adjustable to  
Adaptable a  
Adaptable à  
(max)  
1/1 100 mm  
1/2 150 mm

REF	Type / Tipo	Cut / Corte / Coupe mm	Holes / Agujeros / Troux	
400N		4,8	37	1
402NC		9,5	19	1
401N		1,9	19	1 <b>NEW</b>

\*Y 48,3 cm H 45,7 cm Open / Abierto / Ouvert  
\*Y 59,1 cm H 43,5 cm Closed / Cerrado / Fermé

Blade assembly  
Conjunto de cuchillas  
Jeu de lames

REF	For / Para / Pour	Cut / Corte / Coupe mm	Blades / Cuchillas Lames	
DICE & STICKS / DADOS - BASTONCILLOS / CUBES ET BÂTONNETS				
435	400N	4,8	37	1
484C	402NC	9,5	19	1

Cut a quarter head of lettuce at a time.  
Corte un cuarto de cabeza de lechuga a la vez.  
Coupez un quart de tête de laitue à la fois.

5X Faster / Más rápido



**4400N** Salad cutter  
Cortador de lechuga  
Coupe-Salade

LETTUCE  
KING® IV

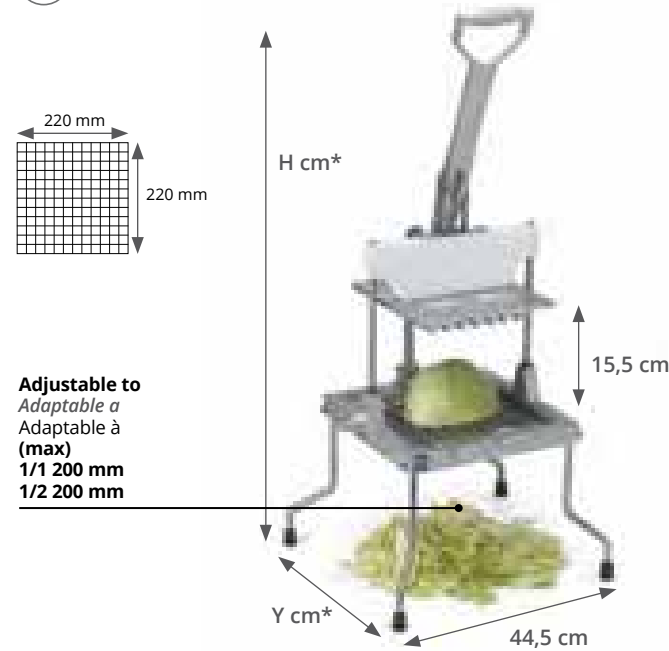

Adjustable to  
Adaptable a  
Adaptable à  
(max)  
1/1 200 mm  
1/2 200 mm

REF	Type / Tipo	Cut / Corte / Coupe mm	
DICE & STICKS / DADOS - BASTONCILLOS / CUBES ET BÂTONNETS			
4400N		25,4 x 25,4	1

\*Y 43,2 cm H 81,3 cm Open / Abierto / Ouvert  
\*Y 47 cm H 54,9 cm Closed / Cerrado / Fermé

Blade assembly  
Conjunto de cuchillas  
Jeu de lames

REF	Type / Tipo	Cut / Corte / Coupe mm	
DICE & STICKS / DADOS - BASTONCILLOS / CUBES ET BÂTONNETS			
4408		25,4 x 25,4	1

Does not bruise the lettuce.  
No oscurece la lechuga.  
N'abîme pas la laitue.

5X Faster / Más rápido

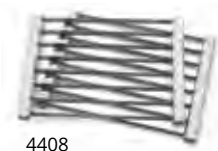

4408

## Manual food processors 5.2

Procesadores manuales de alimentos  
Appareils manuels de transformation des aliments

**403NH** Fruit & vegetable slicer  
Rebanadora de frutas y verduras  
Coup-fruit et légumes



Adjustable to  
Adaptable a  
Adaptable à  
(max)  
1/2 65 mm

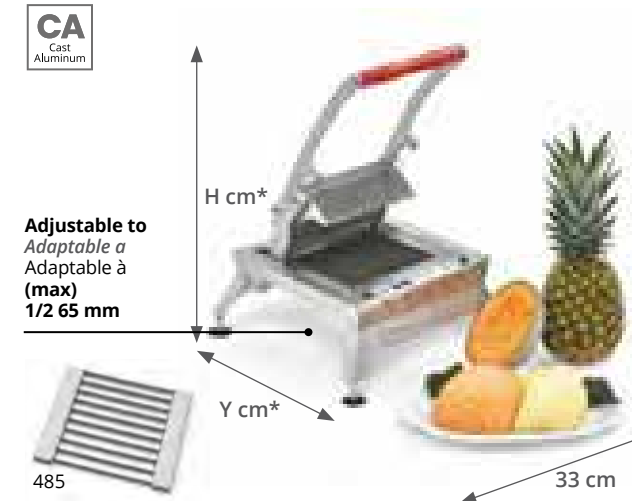

REF	Type / Tipo	Cut / Corte / Coupe mm	Blades / Cuchillas Lames	
CORE / SACACORAZONES / ÉVIDOIR				
403NH		6,4	28	1

\*Y 33,6 cm H 50,8 cm Open / Abierto / Ouvert  
\*Y 55,7 cm H 23,3 cm Closed / Cerrado / Fermé

Replacement blade only  
Solo cuchilla de reemplazo  
Lame de rechange seule

REF	Type / Tipo	Cut / Corte / Coupe mm	Blades / Cuchillas Lames	
CORE / SACACORAZONES / ÉVIDOIR				
485		6,4	28	1

Full 12.7 cm cutting area optimal for large fruits.  
Área de corte completa de 12,7 cm para frutas grandes.  
Longueur de coupe de 13 cm optimale pour les fruits volumineux.

Prevents bruising of fruit during cutting, reducing food waste.  
No oscurece la fruta durante el corte, reduciendo así los desechos.  
N'abîme pas le fruit durant la coupe, réduisant le gaspillage.

**15604** Bloom onion cutter  
Cortador cebollas en flor  
Coupe onion en fleur



36,2 cm

35,6 cm

**500N** Onion cutter  
Cortador de cebollas  
Coupe-onions

ONION KING®



Adjustable to  
Adaptable a  
Adaptable à  
(max)  
1/1 65 mm  
1/2 65 mm  
1/3 100 mm  
1/4 100 mm  
1/6 100 mm

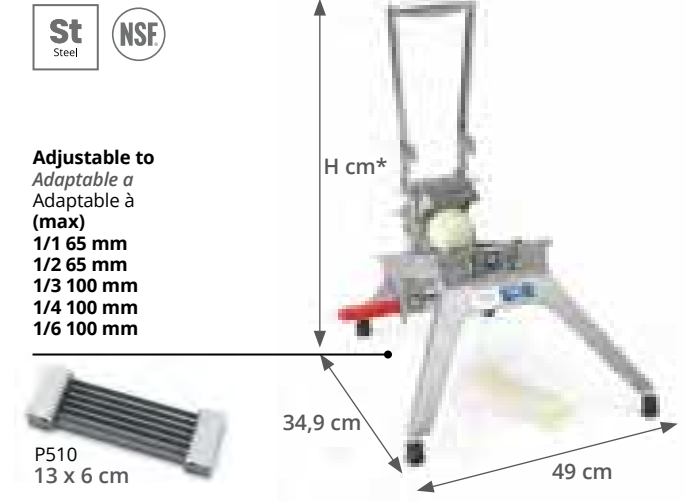

REF	Type / Tipo	Cut / Corte / Coupe mm	Blades / Cuchillas Lames	
CORE / SACACORAZONES / ÉVIDOIR				
500N		4,8	13	1
501N		6,4	11	1

\*H 49 cm Open / Abierto / Ouvert  
\*H 39,4 cm Closed / Cerrado / Fermé

Blade assembly  
Conjunto de cuchillas  
Jeu de lames

REF	FOR / PARA / POUR	Cut / Corte / Coupe mm	Blades / Cuchillas Lames	
509	500N	4,8	13	1
511	501N	6,4	11	1

Exact slice thickness / Espesor de rebanada exacto / Épaisseur de tranches exacte

2,5X Faster / Más rápido



INSTABLOOM® II

REF	Section / Secciones / Quartiers	
15604	24	1

\*H 76,2 cm Open / Abierto / Ouvert  
\*H 48,3 cm Closed / Cerrado / Fermé

Blade assembly  
Conjunto de cuchillas  
Jeu de lames

REF	Section / Secciones / Quartiers	
15601	24	1

Constructed from heavy duty cast aluminum.  
Fabricación de aluminio moldeado altamente resistente.  
En aluminium coulé ultra-robuste.

Features precision edged stainless steel blades.  
Tiene cuchillas de acero inoxidable con bordes de precisión.  
Lames inox de précision.

With suction cup base.  
Con ventosas de agarre en la base.  
Avec ventouse d'accrochement à la base.

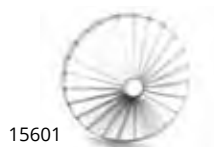

15601

## 5.2 Manual food processors

Procesadores manuales de alimentos  
Appareils manuels de transformation des aliments

### 606N Tomato and lemon wedger Cortador seccionador de tomates y cítricos Diviseur à tomates et agrumes

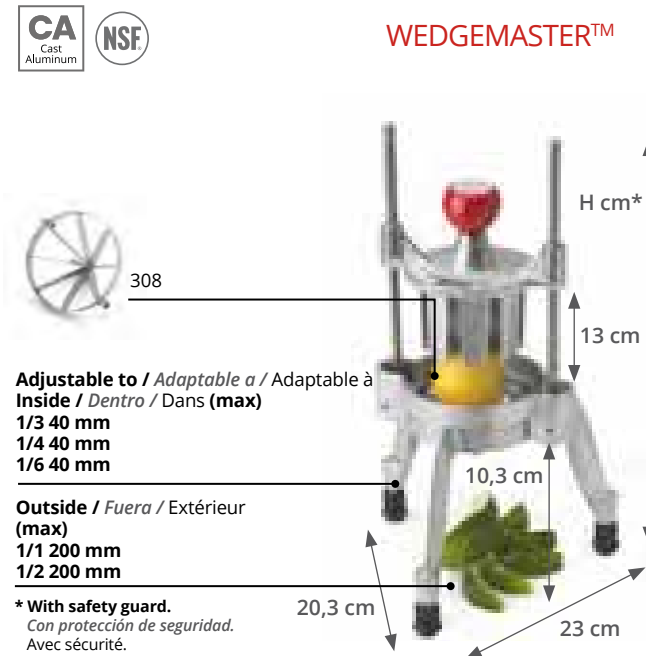

REF	Section / Secciones / Quartiers	Ships with blades Se vende con cuchillas Description de la coupe	
606N	6	P306/P336	1
808N	8	P308/P338	1

REF	Type / Tipo	Section / Secciones / Quartiers	
<b>Blade assembly</b> Conjunto de cuchillas Jeu de lames			
<b>WEDGE / GAJOS / QUARTIERS</b>			
306		6	1
308		8	1

\*H 40,6 cm Open / Abierto / Ouvert  
\*H 40,3 cm Closed / Cerrado / Fermé



### 700-1 Tomato and lemon wedger Cortador seccionador de tomates y cítricos Diviseur à tomates et agrumes



REF	Section / Secciones / Quartiers	
700-1	6	1
700-4	8	1

REF	Type / Tipo	Section / Secciones / Quartiers	
<b>Blade assembly</b> Conjunto de cuchillas Jeu de lames			
<b>WEDGE / GAJOS / QUARTIERS</b>			
704		4	1
706		6	1
708		8	1
712		12	1

\*H 40,6 cm Open / Abierto / Ouvert  
\*H 38,7 cm Closed / Cerrado / Fermé  
Constructed of dishwasher safe polycarbonate material.  
Fabricación de material de policarbonato para lavavajillas.  
En polycarbonate qui passe au lave-vaisselle.



## Manual food processors 5.2

Procesadores manuales de alimentos  
Appareils manuels de transformation des aliments

### P937 Versatil machine Máquina multi-usos Machine universel

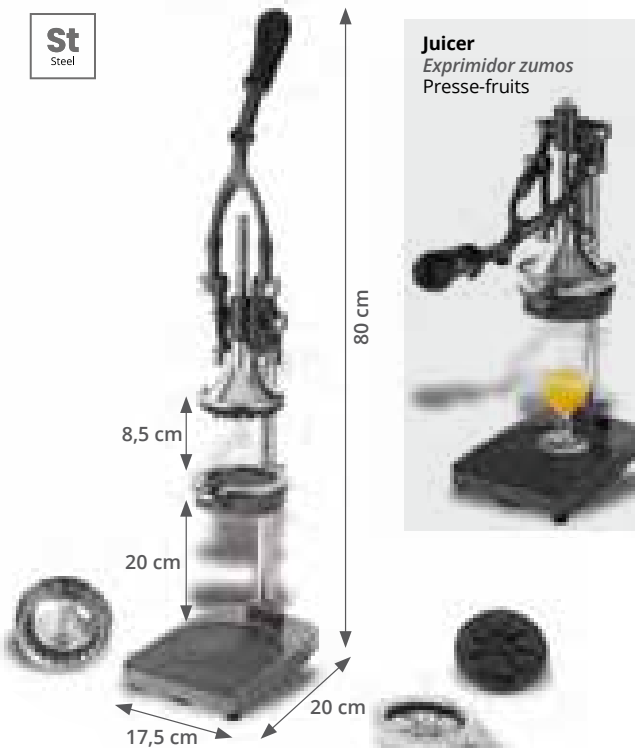

REF	H cm	
P937000	80	1

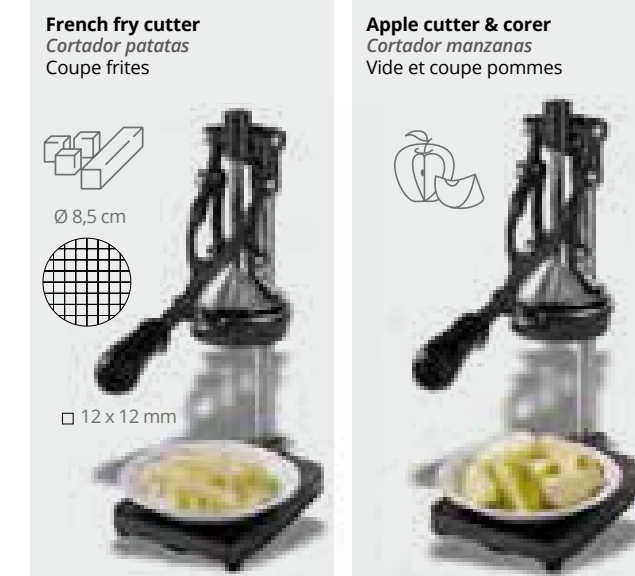

REF	H cm	
RE937001		1
RE937002		1
RE937003		1

### 1811 Cube cutter Cortador en cubos Coupe en cubes

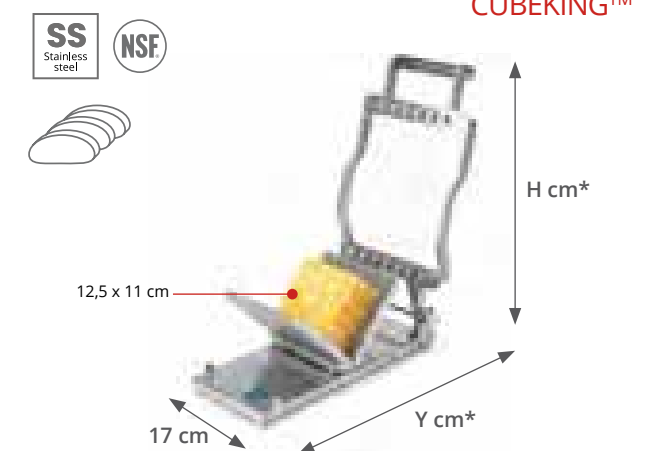

REF	Cut / Corte / Coupe mm	
1811	19,1	1
1812	9,5	1

\*Y 33 cm \*H 34 cm Open / Abierto / Ouvert  
\*Y 32 cm \*H 11 cm Closed / Cerrado / Fermé

REF	
<b>Replacement wire kit</b> Juego de alambres de repuesto Kit de fil de rechange	
1823	1

Produce uniform cheese cubes, sticks, and square or rectangular blocks.  
Produce cubos, palillos y bloques cuadrados o rectangulares de queso.  
Produisez des dés, bâtonnets et blocs carrés ou rectangulaires de fromage.



# Manual food processors 5.2

Procesadores manuales de alimentos  
Appareils manuels de transformation des aliments

## P9759 Tomatoes slicer Cortador de tomates Coupe tomates



REF	Cut / Corte / Coupe mm	cm	Box
P975900	6,4	39 x 21,5 x 20	1
RE975901	6,4	25 x 6,8	12



## 0643N Tomatoes slicer Cortador de tomates Coupe tomates

TOMATO PRO™

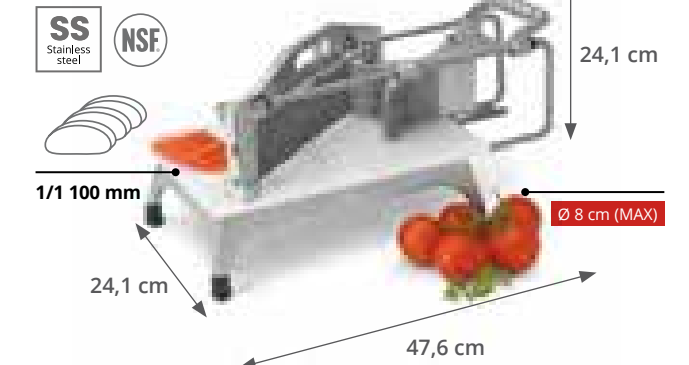

REF	Cut / Corte / Coupe mm	Blades / Cuchillas / Lames	Box
0644N**	6,4	11	1

^ With safety guard.  
Con protección de seguridad.  
Avec sécurité.

Holds firmly on countertop.  
Permite sujeción a la mesa.  
Fixation ferme sur la table.

Replacement blade item  
Cuchilla de reemplazo  
Lame de recharge

REF	Cut / Corte / Coupe mm	Blades / Cuchillas / Lames	Box
*0653	4,8	15	1
**0654	6,4	11	1



## 15105 Tomatoes slicer Cortador de tomates Coupe tomates

INSTASLICE™

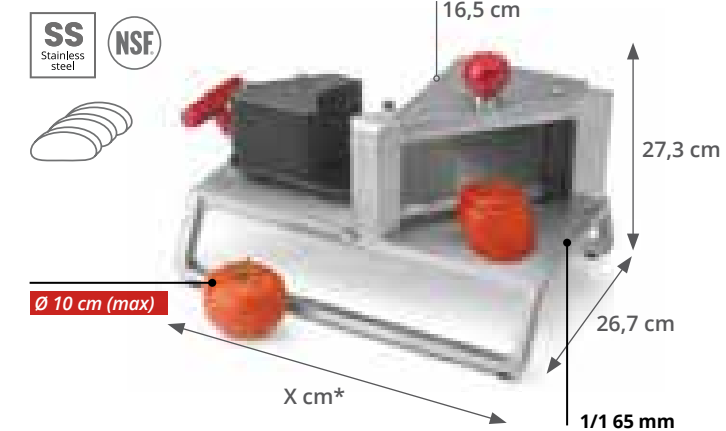

REF	Type / Tipo	Cut / Corte / Coupe mm	Blades / Cuchillas / Lames	Box
15105^	Scalloped	4,8	16	1
15104^	Scalloped	9,5	8	1
15103^	Scalloped	6,4	12	1

\*X 44,5 cm Open / Abierto / Ouvert  
\*X 40,6 cm Closed / Cerrado / Fermé

Replacement blade item  
Cuchilla de reemplazo  
Lame de recharge

REF	Type / Tipo	Cut / Corte / Coupe mm	Blades / Cuchillas / Lames	Box
15115^	Scalloped	4,8	16	1
15209^^	Scalloped	4,8	16	1
15113^	Scalloped	6,4	12	1
15114^	Straight	9,5	8	1

'Pop-in pop out' blade assemblies for easy replacement.  
Conjuntos de cuchillas encajables para facilitar el reemplazo.  
Lames qui s'installent et se sortent par détente pour un remplacement facile.

5X Faster / Más rápido  
Corrosion resistant.  
Resistente a la corrosión.  
Résistant à la corrosion.

## 5.2 Manual food processors

Procesadores manuales de alimentos  
Appareils manuels de transformation des aliments

**P9640** St/Steel can opener  
Abrelatas industrial acero inoxidable  
Ouvre-boîtes professionnel en acier inoxydable



55 cm  
Maximum height of cans.  
Altura máxima de las latas.  
Hauteur maximale des boîtes.

REF	H cm	
P964001	60	6

**Knife (spare part)**  
Cuchilla de recambio  
Couteau (pièce de rechange)

REF		
RE964100		8

**Wheel (spare part)**  
Rodillo de recambio  
Rouleau (pièce de rechange)

REF		
RE964200		1

**P938** Garlic Press  
Prensa ajos  
Presse-ail



REF		
P938000		24

VOLLRATH

**P390** St/Steel egg slicer  
Cortahuevos guitarra de acero inox  
Coupe-oeuf en acier inox



REF	cm	
P390000	7,7 x 9,4	120

**P3901** 2 way egg cutter  
Cortahuevos doble uso  
Coupe-oeuf 2 utilisations



REF	W x D x H cm	
P390100	11,5 x 9,5 x 3,5	48

**P610** Apple cutter & corer  
Cortador y descorazonador manzanas  
Vide et coupe pommes



**St/Steel blades with cast aluminium frame**  
Cuchilla en acero inoxidable y marco en aluminio de fundición  
Lames inox et manche en aluminium fonté



REF	Ø cm	
P610000	8,5	24

138

pujadas

## Manual food processors 5.2

Procesadores manuales de alimentos  
Appareils manuels de transformation des aliments

**P9755** "V" shaped mandoline slicer  
Mandolina corte "V"  
"V" mandoline



**Includes: 2 julienne blades + 3 thickness guides (1 mm / 2 mm / 3 mm)**  
Incluye: 2 cuchillas + 3 guías plástico grosor (1 mm / 2 mm / 3 mm)  
Comprend: 2 lames julienne + 3 guides épaisseur (1 mm / 2 mm / 3 mm)

**Non-slip rubber feet.**  
Pies goma antideslizantes.  
Pieds en caoutchouc antidérapants.

REF	Cut / Corte / Coupe mm	Blades / Cuchillas / Lames	
P975501	4 / 7	24 / 12	8

**1400** Tomato corer **TOMATO KING®**  
Descorazonador de tomates  
Permet d'ôter le coeur de la tomate



**Stainless steel teeth.**  
Dientes de acero inoxidable.  
Dents en inox.

**Bulk pack**  
Paquete a granel  
Paquet en vrac

REF		
1400		144

VOLLRATH

**P9756** Mandoline  
Mandolina  
Mandoline



**Includes: rotating blades + thickness regulator (3, 6 and 9 mm)**  
Incluye: cuchilla giratoria + regulador de espesor corte (3, 6 y 9 mm)  
Comprend: lames tournantes + régulateur épaisseur (3, 6 et 9 mm)

**Slice, wavy slice and sticks.**  
Rebanada, rebanada ondulada y bastoncillos.  
Tranches, ondulé tranches et bâtonnets.

REF	Cut / Corte / Coupe mm	Blades / Cuchillas / Lames	
P975600	4 / 9	23 / 11	8

**15149** Sanitary gel lubricant **PETROL GEL**  
Gel lubricante sanitario  
Gel lubrifiant sanitaire



REF	ml	
15149	118	1

139

pujadas

# Cutting boards 5.3

Tablas de corte

Planches à découper

UTENSILIOS  
UTENSILS  
USTENSILIES



**RAW FISH**  
PESCADO CRUDO  
POISSON CRU



**RAW MEAT**  
CARNE CRUDA  
VIANDE CRU



**RAW POULTRY & CHIKEN**  
CARNE CRUDA DE AVE  
VIANDE CRU ET VOLAILLES



**ALLERGEN-FREE**  
ANTIALÉRGICO  
ANTI ALLERGIQUE



**BAKERY & DAIRY**  
PAN Y LÁCTEOS  
PAIN ET PRODUITS LAITIERS



**COOKED MEAT**  
CARNE GUISADA  
VIANDE CUISINÉE



**FRUIT & VEGETABLES**  
FRUTA Y VEGETALES  
FRUIT ET LÉGUMES



**PRESENTATION**  
PRESENTACIÓN  
PRÉSENTATION

We introduce here with the new range of cutting board with more than 20 different patterns and more than 100 references conceived to fulfill all the market needs. We also offer the possibility to produce special sizes and thicknesses upon request. This new range of cutting boards is presented in two different materials, one made of Polyethylene (PE) using the injection technique and the widest range on High Density Polyethylene 500 (HD PE 500) through thermo compression.

Presentamos una nueva gama de tablas de corte con más de 20 modelos distintos y más de 100 referencias, concebidas para satisfacer todas las necesidades del mercado. Ofrecemos también la posibilidad de fabricar medidas y grosores especiales sobre pedido. La nueva gama de tablas de corte se presenta en dos modalidades; unas fabricadas en Polietileno (PE) por inyección y la gama más extensa en Polietileno 500 alta densidad (HD PE 500) por termocompresión.

Nous présentons une nouvelle gamme de planches à découper avec plus de 20 modèles différents et plus de 100 références, conçues pour satisfaire tous les besoins du marché. Nous offrons aussi la possibilité de fabriquer des planques avec des mesures et des épaisseurs spéciales sur commande. Cette nouvelle gamme de planches à découper se présentent en deux matériaux différents: certaines sont produites en Polyéthylène (PE) par injection et la majorité de la gamme est produite en Polyéthylène 500 de haute densité (HD PE 500) par thermo compression.



## MAIN FEATURES

The cutting boards made of High Density Polyethylene 500 have higher molecular weight (HMWPE), offering the following properties:

- High DURABILITY
- 25% more resistance to ABRASION
- Higher Fusion temperature: 135,4 °C
- Softening temperature: 83 °C
- Extraordinary RIGIDNESS

\* Do not present deformation during the rinsing process of industrial dishwasher cleaning cycle (max. temp. aprox. 80 °C).

Following the CE 1935/2004 regulation.

## CARACTERÍSTICAS PRINCIPALES

Las tablas de corte fabricadas en Polietileno 500 alta densidad, se caracterizan por un alto peso molecular (HMWPE) ofreciendo:

- Alta DURABILIDAD
- 25% más resistencia a la ABRASIÓN.
- Mayor temperatura de fusión: 135,4 °C.
- Temperatura de reblandecimiento: 83 °C
- Mayor RIGIDEZ

\* No presentan deformación durante el aclarado del ciclo de lavado en lavavajillas industriales (temp. máx. aprox. 80 °C).

Conforme a las normativas siguientes: RD 1712/91 registro sanitario de alimentos CE 1935/2004.

## CARACTÉRISTIQUES PRINCIPALES

Les planches à découper fabriquées en Polyéthylène 500 haute densité ont un poids moléculaire (HMWPE) plus grand qui offre les suivantes propriétés:

- Longue DURÉE
- 25% plus résistant à l'ABRASION
- Température de fusion: 135,4 °C
- Température de ramolissement: 83 °C
- RIGIDITÉ maximale

\* Ne présente pas de déformation lors du cycle lavage dans le lave-vaisselles industriel (Temp. max. aprox. 80 °C).

Conforme à la réglementation 1935/2004.

## P9118 30 x 20 x 2



**With silicon feet**  
Con pies silicona  
Avec pieds en silicone

REF	Color	W x D x H cm	
P911801		30 x 20 x 2	1
P911802		30 x 20 x 2	1
P911803		30 x 20 x 2	1
P911804		30 x 20 x 2	1
P911805		30 x 20 x 2	1
P911806		30 x 20 x 2	1
P911808		30 x 20 x 2	1

## P9112



**With silicon feet**  
Con pies silicona  
Avec pieds en silicone

REF	Color	W x D x H cm	
P911201		40 x 30 x 2	6
P911202		60 x 40 x 2	3

## P9120 40 x 20 x 2

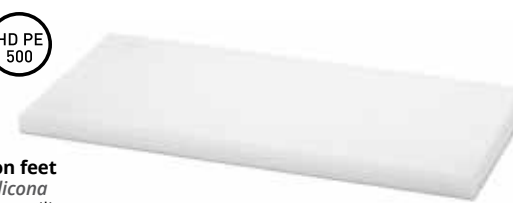

**With silicon feet**  
Con pies silicona  
Avec pieds en silicone

REF	Color	W x D x H cm	
P912001		40 x 20 x 2	1

## P9113 GN 1/1



**With groove With silicon feet**  
Con ranura Con pies silicona  
Avec rigole Avec pieds en silicone

REF	Color	W x D x H cm	
P911301		53 x 32,5 x 2	5
P911302		53 x 32,5 x 2	5
P911303		53 x 32,5 x 2	5
P911304		53 x 32,5 x 2	5
P911305		53 x 32,5 x 2	5
P911306		53 x 32,5 x 2	5

## P9117 GN 1/2 320 x 265 x 20



**With silicon feet**  
Con pies silicona  
Avec pieds en silicone

REF	Color	W x D x H cm	
P911701		32 x 26,5 x 2	1

## P9114 40 x 30 x 2



**With silicon feet**  
Con pies silicona  
Avec pieds en silicone

REF	Color	W x D x H cm	
P911401		40 x 30 x 2	1
P911402		40 x 30 x 2	1
P911403		40 x 30 x 2	1
P911404		40 x 30 x 2	1
P911405		40 x 30 x 2	1
P911406		40 x 30 x 2	1
P911408		40 x 30 x 2	1

See products on / Ver productos en / Voir produits en page

P. 198

**Stand for GN lids**  
Soporte para tapas GN  
Support pour couvercles GN

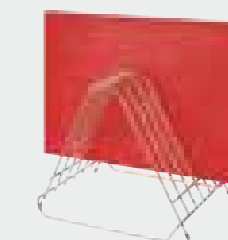



## 5.3 Cutting boards

Tablas de corte  
Planches à découper

### P9119 50 x 30 x 2



With silicon feet  
Con pies sílicona  
Avec pieds en silicone

REF	Color	W x D x H cm	
P911901	White	50 x 30 x 2	1
P911902	Red	50 x 30 x 2	1
P911903	Blue	50 x 30 x 2	1
P911904	Yellow	50 x 30 x 2	1
P911905	Green	50 x 30 x 2	1
P911906	Brown	50 x 30 x 2	1
P911908	Black	50 x 30 x 2	1

### P9115 GN 1/1 53 x 32,5 x 2



With silicon feet  
Con pies sílicona  
Avec pieds en silicone

REF	Color	W x D x H cm	
P911501	White	53 x 32,5 x 2	1
P911502	Red	53 x 32,5 x 2	1
P911503	Blue	53 x 32,5 x 2	1
P911504	Yellow	53 x 32,5 x 2	1
P911505	Green	53 x 32,5 x 2	1
P911506	Brown	53 x 32,5 x 2	1
P911508	Black	53 x 32,5 x 2	1

### P9116 60 x 40 x 2



With silicon feet  
Con pies sílicona  
Avec pieds en silicone

REF	Color	W x D x H cm	
P911601	White	60 x 40 x 2	1
P911602	Red	60 x 40 x 2	1
P911603	Blue	60 x 40 x 2	1
P911604	Yellow	60 x 40 x 2	1
P911605	Green	60 x 40 x 2	1
P911606	Brown	60 x 40 x 2	1
P911608	Black	60 x 40 x 2	1

### P9135 Bar



Without feet  
Sin pies  
Sans pieds

REF	Color	W x D x H cm	
P913501	White	16 x 25 x 1	1
P913601	White	25 x 20 x 1	1
P913701	White	30 x 20 x 1	1
P913901	White	32 x 24 x 1	1

### P911407



With silicon feet  
Con pies sílicona  
Avec pieds en silicone

REF	W x D x H cm	
P911407	40 x 30 x 2	1
P911507	53 x 32,5 x 2 (1/1)	1
P911607	60 x 40 x 2	1

### P9130 Cutting board table

Mesa de corte  
Table de découpe



With groove  
Con ranura  
Avec rigole

Delivered without the GN container  
No incluye contenedor Gastronorm  
Livré sans le bac GN

Perfect for storing direct cut products into a 1/3 GN pan  
Para almacenar alimentos recién cortados en cubeta GN 1/3  
Permet découper les produits directement au dessus du bac Gastronorme 1/3

REF	Color	W x D x H cm	
P913000	White	65 x 40 x 11	1

### P901 St/Steel vegetable picker

Recogeverduras inox  
Pelle à légumes inox



REF	cm	
P901014	14 x 10	1
P901018	18 x 12	1



## 5.4 Measuring utensils

Elementos de medida  
Ustensiles de mesure

**47058** Oval measuring scoop  
Cuchara oval medidora  
Cuillère à mesurer ovale



NEW!



REF	L cm	ml	
47058	25,5	120	12

**47054** Set 3 measuring oval scoops  
Set de 3 cucharas ovals medidoras  
Set de 6 cuillères à mesurer ovals



NEW!



REF	ml	
47054	30 / 60 / 120	5

**4702** Long handle round measuring spoon  
Cuchara medidora redonda mango largo  
Cuillère à mesurer ronde à long manche



NEW!



REF	ml	
47025	1	12
47026	2	12
47027	5	12
47028	15	12
47029	30	12

**47031** 5 piece round measuring spoon long handle  
Set de 5 cucharas medidoras con mango  
Set de 5 cuillères à mesurer avec poignée



NEW!



REF	ml	
47031	30 / 15 / 5 / 2,5 / 1,25	12

**44572** 5-piece measuring ladle set  
Set de 5 cucharones medidores  
Set de 5 cuillères à mesurer



NEW!



REF	ml	
44572	15 / 5 / 2,5 / 1 / 0,5	12

**46588** 6-piece oval measuring spoon set  
Set de 6 cucharas ovals medidoras  
Set de 6 cuillères à mesurer ovals



NEW!



REF	ml	
46588	15 / 10 / 5 / 2,5 / 1,25 / 0,625	12

## Measuring utensils 5.4

Elementos de medida  
Ustensiles de mesure

**46589** 4- straightside measuring spoon set.  
Set de 4 cucharas medidoras  
Set de 4 cuillères à mesurer



NEW!



REF	ml	
46589	30 / 15 / 10 / 5	12

**47119** Set 4 tazas medidoras  
4- piece measuring cup set  
Set de 4 tasses à mesurer



NEW!



REF	ml	
47119	240 / 120 / 80 / 60	12

**47118** 4-piece round measuring spoon set  
Set 4 cucharas medidoras redondas  
Set de 4 cuillères à mesurer rondes



NEW!



REF	ml	
47118	15 / 5 / 2,5 / 1,25	12

**P6045** St/Steel 4 pcs set measuring cups  
Juego 4 cazos de medidas inox  
Set 4 casseroles doseur



REF	ml	
P604500	59 - 78 - 118 - 236	12

**466** Ramekins  
Ramekin  
Ramequin



NEW!



REF	Ø cm	ml	
46654	5,7	59	12
46655	6,7	89	12
46661	7,6	118	12

**4665** Measuring ramekins  
Ramekin medidor  
Ramequin à mesurer



NEW!

Capacities clearly stamped on product  
Capacidades claramente indicadas en el producto  
Capacités indiquées sur le produit



REF	Ø cm	ml	
46656	7,9	118	12
46657	9,8	236	12
46658	11,2	354	12
46659	12,3	473	12

## 5.4 Measuring utensils

Elementos de medida  
Ustensiles de mesure

**95160** Graduated measuring cup set  
Kit tazas medidoras  
Kit tasses à mesurer



REF	Ø cm	Lts	
95160	8,8	0,47	6
95320	11,7	0,90	6
95640	9,0	1,90	6

**682-683** Aluminum measuring cups  
Tazas medidoras de aluminio  
Tasses à mesurer en aluminium



REF	H cm	Lts	
68297	10,6	0,5	6
68296	14,0	0,9	6
68351	18,0	1,9	6
68352	23,5	3,8	6

**P604** Measuring jug  
Jarra de medidas  
Pot mesureur



REF	Lts	
P604001	1,00	1
P604002	2,00	1

**P846** Polypropylene measuring jug  
Jarra de medidas en polipropileno  
Pot mesureur en polypropylène



REF	Lts	
P846025	0,25	25
P846050	0,50	16
P846100	1,00	12
P846200	2,00	12
P846300	3,00	10

**P603** Bucket with base  
Cubo con base  
Seau avec base

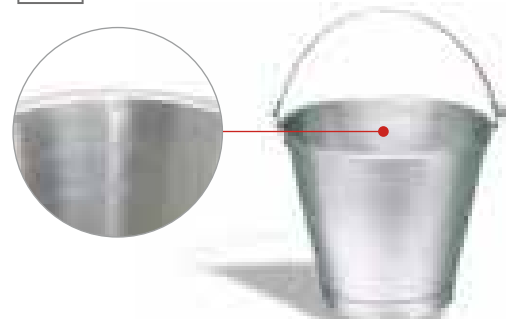

REF	Ø cm	H cm	Lts	
P603012	31,0	28,50	12,00	1
P603015	32,5	32,50	15,00	1

## Measuring utensils 5.4

Elementos de medida  
Ustensiles de mesure

**P609** Electronic scale  
Balanza digital  
Balance électronique



Power cable not included. Battery powered  
Cable de alimentación no incluido. Funciona con pilas  
Câble d'alimentation non inclus. Fonctionne avec des piles

REF	kg	min. g	
P609010	10	20	6

**P6097** Electronic kitchen scale  
Balanza electrónica  
Balance électronique



High accuracy  
Multi-function weight and counting  
Energy-saving system  
Plastic Platform.

Gran precisión  
Multifunción de peso  
Contador de piezas  
Sistema ahorro energía  
Bandeja de plástico.

Haut précision  
Multi-fonction des poids  
Compteur des pièces  
Système d'économie d'énergie  
Plateau en plastique.



Ref	kg	Grs	Surface / Plataforma / Plateau Ø cm	
P609705	5	1	11	60

**P611** Kitchen timer alarm  
Reloj de cocina digital  
Minuteur de cuisine



Battery not included  
Pila no incluida  
Pile non incluse



REF	W x D x H cm	
P611000	6,8 x 6,8 x 2,5	200

**P6092** Digital kitchen scale  
Balanza digital  
Balance électronique



Surface made of St/Steel. LED Display. Battery powered  
Plataforma en acero inoxidable. Pantalla LED. Funciona con pilas  
Plateau fabriquée en acier inoxydable. Scran LED. Fonctionne avec des piles

REF	kg	min. g	d (g)	
P609200	15	40	1	10

**P9804** Infrared thermometer with laser pointer  
Termómetro infrarrojos con mira laser  
Thermomètre infra-rouge à visée laser



LCD Display  
Pantalla LCD  
Écran LCD



**IDEAL!**  
Non-contact temperature measure food's surface.  
Ideal para medir la temperatura de la superficie de los alimentos, sin contacto.  
Ideal pour la mesure de température de surface des aliments, sans contact.

REF	L cm	Temp.	
P980400	17	-60 °C / +500 °C	1

**P9802** Cooking thermometer  
Termómetro de cocción  
Thermomètre à cuisson



With plastic protection  
Con protección de plástico  
Avec gaine plastique

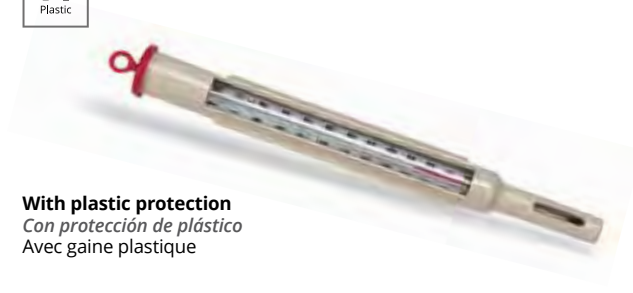

REF	L cm	Temp. max.	
P980200	28	100 °C	1

## 5.4 Measuring utensils

Elementos de medida  
Ustensiles de mesure

**P9816** Cooking thermometer  
Termómetro de cocción  
Thermomètre à cuisson



With plastic protection  
Con protección de plástico  
Avec gaine plastique

REF	L cm	Temp.	
P981600	17	-10 °C / +200 °C	1

**P9815** Cooking thermometer with timer  
Termómetro digital de cocción con temporizador  
Thermomètre à cuisson avec temporisateur



**P981650** Pocket thermometer with protection  
Termómetro bolsillo con protección  
Thermomètre de poche avec protection



REF	L cm	Temp.	
P981650	14,3	-40 °C / +70 °C	72

REF	guage + cable sonda + cable sonde + câble L cm	Temp.	
P981500	9	0 °C / +200 °C	1

White plastic.  
Magnetic base for attachment on metal surface.  
Programmable temperature/time, with alarm signal.  
St/Steel probe and wire cable.

Plástico blanco.  
Base magnética para sujeción en superficies de metal.  
Temperatura/tiempo programable con señal de alarma.  
Sonda de acero inoxidable y cable alambre.

Plastique blanc.  
Base magnétique pour l'attacher à une surface métallique.  
Température/temps programmable avec sonnette d'alarme.  
Sonde inox et filet.

**P9800** Cold storage thermometer  
Termómetro nevera  
Thermomètre congélateur



Enameled finish  
Acabado esmaltado  
Émaillé

REF	L cm	Temp.	
P980000	28	-30 °C / +50 °C	1

**P98005** Horizontal refrigerator thermometer  
Termómetro nevera horizontal  
Thermomètre congélateur horizontal



REF	cm	Temp.	
P980050	13,5 x 3,5	-40 °C / +20 °C	72

## Mitt 5.5

Manopla  
Gan

**P9473** Heat protection gloves  
Guantes protección térmica  
Gants protection thermique



Sold in pairs  
Se venden por pares  
Vendues par paires

- Resistant to contact heat. 100°C for 15 minutes.  
- Great resistance to abrasion, greater durability.  
- Resistant to grease, water, oil and dust.

- Resistente al calor por contacto. 100°C durante 15 minutos.  
- Gran resistencia a la abrasión, mayor durabilidad.  
- Resistente a grasa, agua, aceite y polvo

- Résistant à la chaleur par contact. 100°C pendant 15 minutes.  
- Grande résistance à l'abrasion, plus grande durabilité.  
- Résistant à la graisse, à l'eau, à l'huile et à la poussière

REF	Size / Talla / Taille	
P947302	M	1
P947303	L	1

**P9474** Silicone oven mitt  
Manopla Silicona  
Moufle en silicone



REF	L cm	
P947400	30	1

**P9477** Silicone oven glove with cotton cover  
Manopla silicona con funda algodón  
Gant silicone à fourreau coton



REF	L cm	
P947700	42,5	1

**P9476** Silicone pot-grabber  
Paño de silicona  
Torchon en silicone

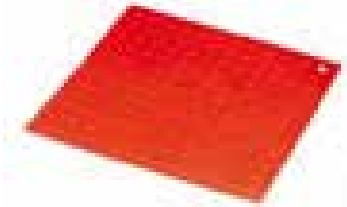

REF	cm	
P947600	17,5 x 17,5	12

## Natural rubber mats

Alfombras caucho  
Tapis en caoutchouc

**P26000** Mat  
Alfombra  
Tapis



REF	W x D x H cm	
P26000	90 x 150 x 1,20	1

**P26001** Mat  
Alfombra  
Tapis



You can connect these mats forming bigger surfaces.

Estas alfombras se pueden conectar unas con otras formando mayores superficies.

Avec système de liaison pour composer une surface plus grande.

REF	W x D x H cm	
P26001	90 x 90 x 1,20	1

# 6 Ice-cream utensils & pastry

*Heladería y pastelería*

Ustensiles à glace et pâtisserie

## 6.1 ICE-CREAM UTENSILS

UTENSILIOS HELADERÍA  
USTENSILES POUR GLACE

152

## 6.2 PASTRY UTENSILS

UTENSILIOS DE PASTELERÍA  
USTENSILES DE PÂTISSERIE

154

## 6.3 NON-STICK MOULDS

MOLDES ANTIADHERENTES  
MOULES ANTI-ADHÉSIFS

163

## 6.4 PASTRY CUTTER

CORTAPASTAS  
DÉCOUPOIRS

166

## 6.5 ST/STEEL PASTRY MOULDS

MOLDES ACERO INOXIDABLE  
MOULES EN ACIER INOX

167

## 6.6 BAGS AND TUBES

MANGAS Y BOQUILLAS  
POCHES ET DOUILLES

170

## 6.7 FLEXIPAN MOULDS

MOLDES FLEXIPAN  
MOULES FLEXIPAN

175

## 6.8 SILICONE MOULDS

MOLDES SILICONA  
MOULES SILICONE

182

## 6.1 Ice-cream utensils

Utensilios heladería  
Utensiles pour glace

### 47169 Ice cream scoop Racionador de helado Cuillère à glace

SS  
Stainless steel



NEW!

REF	Size Tamaño	L cm	ml	
47169	14	68,0	26	10
47170	20	46,0	46	10
47171	24	38,0	38	10
47172	30	28,0	28	10
47200	40	22,2	22	10

### P331 Ice cream scoop Racionador de helado Cuillère à glace

SS  
Stainless steel



REF	Ø cm	ml	
P331039	3,9	15	120
P331044	4,4	22	120
P331050	5,0	32	120
P331056	5,6	46	120
P331059	5,9	54	120
P331066	6,6	75	120
P331070	7,0	90	120

### 47274 Ice cream scoop Racionador helado Cuillère à glace

Bol cm



L cm

### 47150 Round squeeze disher Racionador helado Doseur à presser ronde

SS  
Stainless steel



REF	Size Tamaño	L cm	ml	
T7206	6	23,2	158	12
47150	8	23,2	118	12
47151	10	22,5	92	12
47152	12	22,5	81	12 NEW
47153	16	21,6	59	12
47154	20	21,6	44	12 NEW
47155	24	21,0	41	12
47156	30	21,0	37	12 NEW
47157	40	20,3	26	12
47158	50	20,0	18	12 NEW
47159	60	19,7	17	12
47160	70	19,7	14	12
47161	100	19,1	11	12

### P908 Ice cream scoop Racionador de helado Cuillère à glace

SS  
Stainless steel

Mc  
Methacrylate



\*Methacrylate

REF	Colour / Color / Couleur	L cm	
P908000	White / Blanca / Blanc	26	50
P908001*	Clear / Transparente / Transparente	26	100
P908002	Red / Roja / Rouge	26	100
P908003	Blue / Azul / Bleu	26	1
P908004	Yellow / Amarilla / Jaune	26	1

REF	Color	Size Tamaño	Bol cm	L cm	ml	
47274	●	10	5,4	19,5	118,3	12
47275	●	12	5,2	19,5	88,7	12
47276	●	16	4,8	19,5	73,9	12
47277	●	20	4,4	19,0	59,1	12
47278	●	24	4,1	19,5	44,4	12
47279	●	30	3,7	19,0	29,6	12

## Ice-cream utensils 6.1

Utensilios heladería  
Utensiles pour glace

### P914 36 x 16,5 cm

18/10  
Stainless steel



REF	W x D x H cm	Lts	
P914080	36 x 16,5 x 8	3,4	10
P914120	36 x 16,5 x 12	5,0	10
P914150	36 x 16,5 x 15	7,0	10

### P915 36 x 25 cm

18/10  
Stainless steel



REF	W x D x H cm	Lts	
P915080	36 x 25 x 8	5,4	10

### P9161 360 x 165 mm

PC  
Polycarbonate



REF	cm	H cm	Lts	
P916120	36 x 16,5	12	5	1

### P917 360 x 250 mm

PC  
Polycarbonate



REF	W x D x H cm	Lts	
P917080	36 x 25 x 8	3,4	1

### P9160 Polycarbonate lid Tapa policarbonato Couvercle en polycarbonate

PC  
Polycarbonate

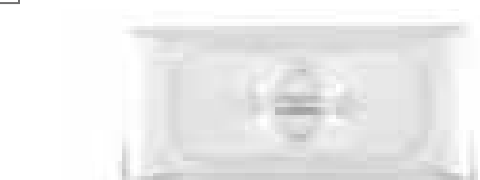

Adjustable for St/Steel Ice cream containers.  
Adaptable a cubetas heladería inox y policarbonato.  
Adaptable aux récipient à glace en acier inox.

REF	cm	
P916000	36 x 16,5	1

### P332 Ice cream cup Copa helado Coupe à glace

SS  
Stainless steel



P332010

P332095

REF	Ø cm	H cm	Lts	
P332095	9,5	8,5	0,15	100
P332010	10,5	6,0	0,17	120

## 6.2 Pastry utensils

Utensilios de pastelería  
Ustensiles de pâtisserie



**P120101 GN Pastry Pan**  
Cubeta GN Pastelería  
Bac GN pâtisserie

NEW!



REF	GN	W x D x H cm	
P120101	1/2	32,5 x 26,5 x 1	1

**P230101 GN Pastry Pan**  
Cubeta GN Pastelería  
Bac GN pâtisserie

NEW!



REF	GN	W x D x H cm	
P230101	2/3	35,3 x 32,5 x 1	1

**P110101 GN Pastry Pan**  
Cubeta GN Pastelería  
Bac GN pâtisserie

NEW!



REF	GN	W x D x H cm	
P110101	1/1	53 x 32,5 x 1	1

**P306 Mixing boiler**  
Caldero timbal  
Bol mixeur



REF	Ø cm	H cm	Lts	
P306035	35	18	10	1

**P3070 Boiler**  
Caldero fondo plano  
Bassine à fond plat



REF	Ø cm	H cm	Lts	
P307020	20	10,5	2,2	1
P307025	25	11,5	3,5	1
P307030	30	14,0	6,0	1
P307035	35	14,5	8,5	1
P307040	40	16,5	13,0	1
P307045	45	17,5	20,0	1
P307050	50	20,0	25,0	1
P307060	60	22,5	45,0	1
P307070	70	24,5	65,0	1

**P3071 Conical boiler**  
Caldero fondo bombeado  
Bassine à fond bombé / Kessel



REF	Ø cm	H cm	Lts	
P307125	25	13,0	3,8	1
P307130	30	16,0	6,5	1
P307140	40	19,0	13,0	1
P307150	50	23,5	25,0	1

## Pastry utensils 6.2

Utensilios de pastelería  
Ustensiles de pâtisserie

**P356 Kitchen bowl**  
Fuente honda cónica  
Bassine pâtissière



Outer sizes  
Medidas exteriores  
Dimensions extérieures

REF	Ø cm	H cm	Lts	
P356016	16	5,5	0,65	96
P356020	20	7,5	1,30	72
P356024	24	8,5	2,10	36
P356028	28	11,0	3,70	36
P356032	32	12,5	6,00	24

**479 Stainless Steel mixing bowl**  
Bol inox. semi-esférico  
Bassine inox demi-ronde



REF	Ø cm	Lts	
47933	24	2,8	12
47934	28	3,8	12
47935	30	4,7	12
47938	35	7,6	12
47943	40	12,0	6

**P764 Hemispherical mould**  
Molde semiesférico  
Demi-sphérique



REF	Ø cm	H cm	Lts	
P764008	8	4,0	0,13	1
P764010	10	5,0	0,26	1
P764012	12	6,2	0,45	1

**P951 St/Steel scoop**  
Librador de acero inox  
Pelle à farine en acier inox

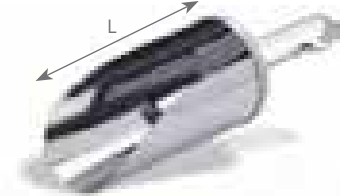

REF	L cm	Lts	
P951010	10	0,1	1
P951015	15	0,4	1
P951019	19	1,0	1
P951024	24	1,7	1

**P953 Aluminum scoop**  
Librador aluminio  
Pelle à farine aluminium



REF	L cm	Lts	
P953001	11,0	0,15	72
P953002	15,0	0,35	72
P953003	18,5	0,71	72
P953004	21,5	1,10	48
P953005	25,5	1,71	36

**P952 Polycarbonate scoop**  
Librador policarbonato  
Pelle à farine polycarbonate

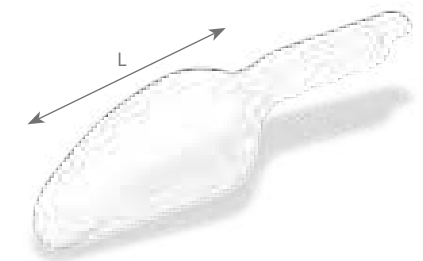

REF	L cm	Lts	
P952001	13,0	0,17	72
P952002	15,5	0,35	72
P952003	17,5	0,71	48

## 6.2 Pastry utensils

Utensilios de pastelería  
Ustensiles de pâtisserie



**P316 Whisk (12 wires)**  
Batidor (12 varillas)  
Fouet (12 fils)



Wire thickness  
Grueso varilla  
Épaisseur des fils  
0,13 cm

REF	L cm	
P316025	25	120
P316030	30	120
P316035	35	120
P316040	40	120
P316045	45	120
P316050	50	120

**P3161 Whisk (10 wires)**  
Batidor (10 varillas)  
Fouet (10 fils)



Wire thickness  
Grueso varilla  
Épaisseur des fils  
0,18 cm

REF	L cm	
P316125	25	120
P316130	30	120
P316135	35	120
P316140	40	120
P316145	45	120
P316150	50	120

**P354 Heavy whisk (8 wires)**  
Batidor grueso (8 varillas)  
Fouet épais (8 fils)



Wire thickness  
Grueso varilla  
Épaisseur des fils  
0,24 cm

REF	L cm	
P354025	25	120
P354030	30	120
P354035	35	120
P354040	40	120
P354045	45	120
P354050	50	120

**P959 Whisk with anti-slip ABS handle (8 wires)**  
Batidor mango ABS antideslizante (8 varillas)  
Fouet avec poignée ABS anti-crispation (8 fils)



Wire thickness  
Grueso varilla  
Épaisseur des fils  
0,2 cm

REF	L cm	
P959025	25	96
P959030	30	1
P959035	35	48
P959040	40	48
P959045	45	24
P959050	50	24

**P393 Big whisk**  
Batidor gigante  
Fouet à purée

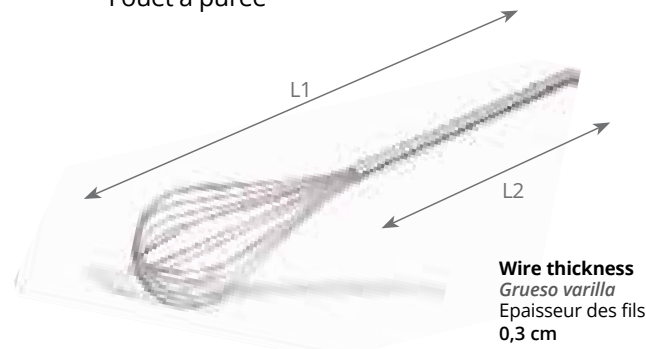

Wire thickness  
Grueso varilla  
Épaisseur des fils  
0,3 cm

REF	L1 cm	L2 cm	
P393080	80	45	12
P393100	100	65	12
P393125	125	90	12

**47002 Whisk with anti-slip handle**  
Batidor con mango antiadherente  
Fouet avec poignée anti-crispation



REF	L cm	L mango cm	
47002	26	12	12
47003	31	12	12
47004	36	12	12
47005	41	12	12

## Pastry utensils 6.2

Utensilios de pastelería  
Ustensiles de pâtisserie

**P398 Rubber spatula**  
Espátula de goma  
Spatule en caoutchouc



REF	L cm	
P398024	25,5	72
P398035	33,0	72
P398042	41,0	72

Anatomical handle. Suitable rubber for food contact. Safe dishwasher. Special mould that prevents the rubber to come off from the handle.

Mango ergonómico. Goma aceptada para uso alimentario. Puede lavarse en el lavavajillas. Moldeado especial que previene la separación de la goma del mango.

Manche anatomique. Caoutchouc conforme au contact alimentaire. Utilisable au lave-vaisselle. Moulage spécial pour éviter la séparation de la gomme du manche.

**P3981 High heat silicone spatula. Bowl scraper**  
Espátula silicona alta temperatura  
Spatule silicone haute température



REF	Peel / Pala / Pelle cm	L cm	
P398125	9 x 6	25	72
P398135	11 x 7	35	72
P398140	11 x 7	40	72

Heat resistance to 260 °C  
Resistente hasta 260 °C  
Résistante à 260 °C

**P9602 Multi-purpose spatula**  
Espátula multi-usos  
Spatule multi-usage



-5 °C  
+70 °C

**P398290 Narrow rubber spatula**  
Espátula estrecha goma  
Spatule étroite en caoutchouc



REF	Peel / Pala / Pelle cm	L cm	
P398290	8,8 x 3,3	25,5	72

**IDEA!** Perfect to empty small jars  
Perfecta para vaciar tarros  
Parfait pour vider des petits pots

**P3982 High heat silicone spoon**  
Cuchara silicona alta temperatura  
Cuillère silicone haute température



REF	Peel / Pala / Pelle cm	L cm	
P398225	9 x 6	25	144
P398235	11 x 7	35	144
P398240	11 x 7	40	144

Heat resistance to 260 °C  
Resistente hasta 260 °C  
Résistante à 260 °C

REF	L cm	
P960225*	25	200
P960230*	30	200
P960235**	35	200

\* Polyestyrene / Poliestireno / Polyestyrène  
\*\* Polyethylene / Polietileno / Polyéthylène



## 6.2 Pastry utensils

Utensilios de pastelería  
Ustensiles de pâtisserie

**P807** Roller docker  
Rodillo para perforar pasta  
Rouleau pour piquer pâtes



REF **P807000** 24

**P839** Roller docker  
Rodillo para perforar pasta  
Rouleau pour piquer pâtes



REF **P839000** 12

**P840** Lattice cutting roller  
Rodillo enrejado  
Rouleau découpoir



REF **P840000** 1

**P842** Double pastry cutter. Plain and serrated  
Cortapastas doble. Liso y rizado  
Roulette à pâtes double. Unie et cannelée



REF **P842000** 12

**P805** Extendable cutter roller 7 castors  
Cortapastas extensible 7 ruedas  
Rouleau extensible 7 roulettes

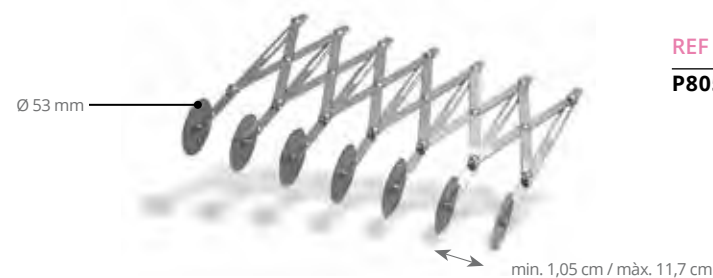

REF **P805000** 36

## Pastry utensils 6.2

Utensilios de pastelería  
Ustensiles de pâtisserie

**P801** St/Steel rolling pin  
Rodillo acero inox  
Rouleau pâtissier acier inox

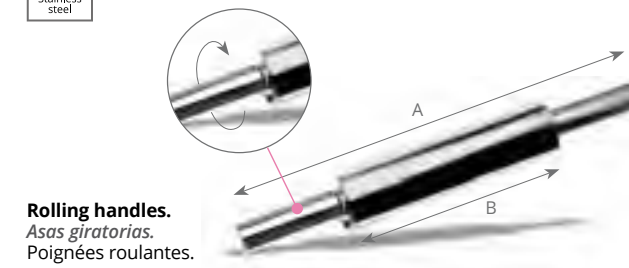

Rolling handles.  
Asas giratorias.  
Poignées roulantes.

REF	A cm	B cm	Ø cm	12
<b>P801040</b>	40	20	5,1	12
<b>P801048</b>	48	25	6,4	8

**P802** Polyethylene rolling pin with handles  
Rodillo polietileno con asas  
Rouleau en polyéthylène avec poignées

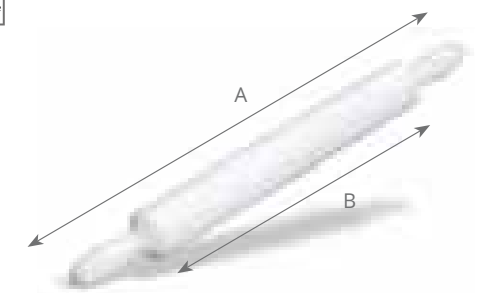

REF	A cm	B cm	Ø cm	1
<b>P802000</b>	60	40	4,8	1

**P803** Polyethylene rolling Pin without handles  
Rodillo polietileno sin asas  
Rouleau en polyéthylène Sans poignées



REF	L cm	Ø cm	1
<b>P803000</b>	50	4,8	1

**P804** Wooden rolling pin  
Rodillo de madera  
Rouleau en bois

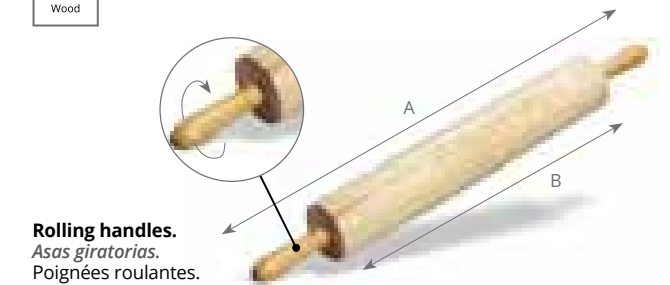

Rolling handles.  
Asas giratorias.  
Poignées roulantes.

REF	A cm	B cm	Ø cm	6
<b>P804000</b>	67,5	45,5	7,7	6

**P845** Polyamide brush  
Pincel de poliamida  
Pinceau en polyamide



Natural fibers  
Fibras naturales  
Fibres Naturelles

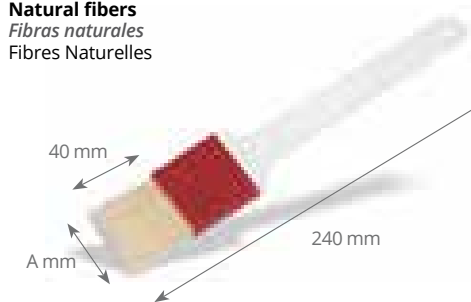

REF	A cm	12
<b>P845040</b>	4,0	12
<b>P845050</b>	5,0	12
<b>P845060</b>	6,0	12
<b>P845075</b>	7,5	12

**P8451** Plastic brush + nylon bristle  
Cepillo plástico + cerdas nylon  
Pinceau plastique + poils nylon

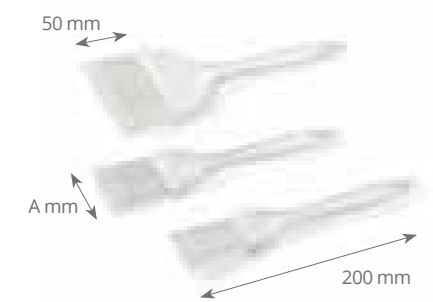

REF	A cm	144
<b>P845138</b>	3,8	144
<b>P845155</b>	5,5	144
<b>P845110</b>	10,0	72

## 6.2 Pastry utensils

Utensilios de pastelería  
Ustensiles de pâtisserie

**P8725** Scraper ABS handle  
Rasqueta mango ABS  
Raclette manche ABS



REF	cm	
P872500	21 x 14,5	144

**P836** Polypropylene scrapers  
Rasquetas de polipropileno  
Raclettes en polypropylène

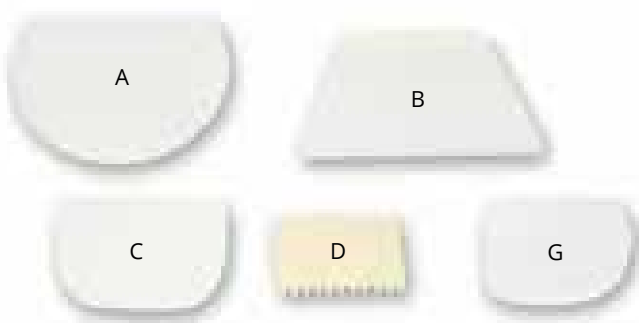

**P848** Double cake divider  
Marcador de tartas doble  
Séparateur de portions double



Ø Total: 26,5 cm

REF	Portions / Porciones	
P848008	8 / 12	1
P848014	14 / 16	1

REF		cm	
P836200	A	20,4 x 15,1	1
P836215	B	22,1 x 13,0	100
P836147	C	15,1 x 10,2	100
P836110	D	11,2 x 7,8	100
P836120	G	12,8 x 9,0	100

REF		cm	
P979100		10 x 13,6	36
P979200		13 x 17,5	1
P979000		16,5 x 21	20

**IDEA!** Kitchen use, defrosting, sterilizing, ice sculpture, crème brûlée, caramelization  
Descongelación, esterilización, escultura de hielo, crema brulée, caramelización  
Décongélation, stérilisation, sculpture de glace, crème brulée, caramélisation

**P979** Pastry torch by gas  
Soplete cocina  
Torche à caraméliser



120 min.  
Lenght / Duración / Durée



P979000  
Super strong flame  
Llama super fuerte  
Flamme extra fort



P979200  
Strong flame  
Llama fuerte  
Fort flamme



P979100  
Standar flame  
Llama normal  
Flamme normal

## Pastry utensils 6.2

Utensilios de pastelería  
Ustensiles de pâtisserie

**P350** St/Steel sieves  
Cedazos en acero inox  
Tamis en acier inox



Detail of the 6 sieves at real scale.  
Detalle de las 6 mallas a escala real.  
Détail des 6 mailles à échelle réelle.

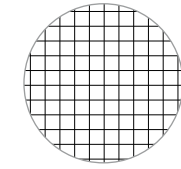

REF	Ø cm	Num	Mesh size / Luz de malla Maillage cm	
P350230	30	10	0,2	6
P350235	34	10	0,2	6

REF	Ø cm	Num	Mesh size / Luz de malla Maillage cm	
P350330	30	14	0,14	6
P350335	34	14	0,14	6

REF	Ø cm	Num	Mesh size / Luz de malla Maillage cm	
P350530	30	25	0,071	6
P350535	34	25	0,071	6

REF	Ø cm	Num	Mesh size / Luz de malla Maillage cm	
P350630	30	35	0,05	6
P350635	34	35	0,05	6

REF	Ø cm	Num	Mesh size / Luz de malla Maillage cm	
P350730	30	50	0,030	6
P350735	34	50	0,030	6

REF	Ø cm	Num	Mesh size / Luz de malla Maillage cm	
P350426	26	20	0,085	6
P350430	30	20	0,085	6
P350435	34	20	0,085	6
P350440	40	20	0,085	6

**P837** Aluminium cake stand  
Expositor de tartas de aluminio  
Présentoir de tartes en aluminium

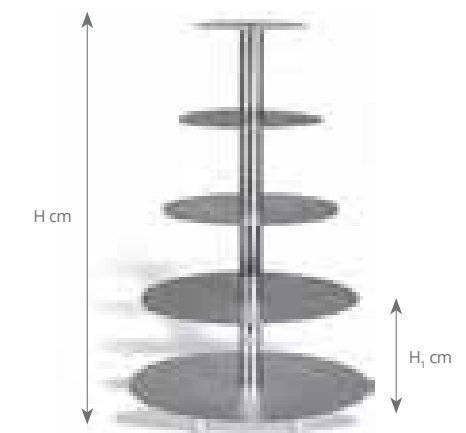

REF	H cm	H <sub>1</sub> cm	Ø cm	
P837003	33	2 x 16,5	20 / 26 / 32	1
P837005	100	4 x 25,0	20 / 26 / 32 / 40 / 45	1
P837007	120	6 x 20,0	16 / 20 / 26 / 32 / 40 / 45 / 50	1

## 6.2 Pastry utensils

Utensilios de pastelería  
Ustensiles de pâtisserie

### P830 Confectionery funnel Embudo dosificador Entonnoir doseur



Tube Ø 0,4 and 0,6 cm included  
Boquilla Ø 0,4 y 0,6 cm incluidas  
Douille de Ø 0,4 et 0,6 cm incluse

REF	Lts	
P830001	1	1
P830002	2	1

### P830005 Basic confectionery funnel with stand Embudo dosificador básico con soporte Entonnoir doseur de base avec support



Funnel and stand sold together.  
Embudo y soporte se venden conjuntamente.  
Entonnoir et support vendu ensemble.

REF	Lts	
P830005	1	6

### 2803 Portion control dispenser Dispensador con control de porciones Distributeur contrôle de la partie



Not recommended for chunky batters.  
No se recomienda para batidos espesos.  
Non recommandé pour les pâtes grumeleuses.

8 portion control settings dispense from 30 a 90 ml.  
Los ajustes de control de 8 porciones dispensan de 30 a 90 ml.  
8 réglages de dose - 30 à 90 ml.

REF	L	W x D x H cm	
2803-18	1,4	15,6 x 27,6 x 19,1	1

### P830003 Economic confectionery funnel and stand Embudo dosificador económico y soporte Entonnoir doseur économique et support



Tube Ø 0,4 and 0,6 cm included  
Boquilla Ø 0,4 y 0,6 cm incluidas  
Douille de Ø 0,4 et 0,6 cm incluse

REF	Lts	
P830003	1	12
P830004		12

See products on **P. 118**  
Ver productos en / Voir produits en page

### P970 Stand for funnel or chinese colander Soporte para embudo o chino Support pour entonnoir ou chinois



### P9095 St/steel pastry grid with feet Rejilla inox pastelería con pies Grille pâtisserie inox avec pieds

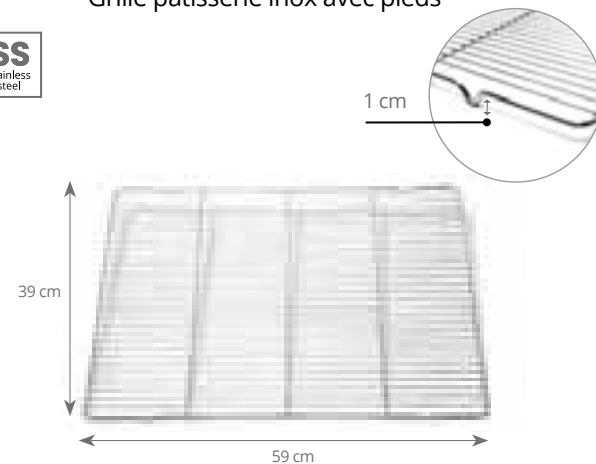

REF	N. Cross-bars N. Travesaños N. Traverses	Ø cm Cross-bars Ø cm Travesaños Ø cm Traverses	N. Wires N. Varillas N. Fils	Ø cm Wires Ø cm Varillas Ø cm Fils	
P909559	3	0,5	29	0,2	10

## Non-stick moulds 6.3

Moldes antiadherentes  
Moules anti-adhésifs



### P7022 Professional cake mould Molde cake profesional Cake embouti professionnel



REF	cm (int.)	H cm	Lts	
P702230	30 x 10,5	8,0	2,0	24

### P702 Cake mould Molde cake Cake embouti



REF	W x D x H cm	
P702026	26 x 9,5 x 7,5	1
P702028	28 x 10 x 7,5	20

### P704 Folding cake mould Molde para paté o cake desmontable Pâté ou cake démontable



REF	W x D x H cm	
P704024	24 x 9,5 x 7	1
P704030	30 x 10 x 7,5	20

### P709 Baking mould w/removable base Molde fondo desmontable Tarte maison a/fond amovible



REF	W x D x H cm	
P709035	35 x 11 x 2,5	1

### P707 Small madeleine sheet Placa madalenas pequeñas Plaque madeleinettes



2 rows of 10 small madeleines of 4,2 cm.  
2 hileras de 10 madalenas pequeñas de 4,2 cm.  
2 rangées de 10 madeleinettes de 4,2 cm.

REF	cm	
P707039	39,5 x 12,5	1

### P706 Madeleine sheet Placa madalenas Plaque madeleines



2 rows of 6 madeleines of 8 cm.  
2 hileras de 6 madalenas de 8 cm.  
2 rangées de 6 madeleines de 8 cm.

REF	cm	
P706039	39,5 x 20	1

## 6.3 Non-stick moulds

Moldes antiadherentes  
Moules anti-adhésifs



**P723 Non-stick spring form**  
*Molde desmontable Antiadherente*  
 Moule rond démontable



REF	Ø cm	H cm	
P723024	24	7,0	6
P723028	28	7,0	6

**P703 High cake mould**  
*Molde para tarta*  
 Manqué rond uni



REF	Ø cm	H cm	
P703020	20	4,5	1
P703024	24	5,0	36
P703028	28	5,0	30
P703032	32	5,5	1

**P710 Round tart mould with fluted edges**  
*Molde rizado para tarta*  
 Tourtière ronde avec Bord cannelé



REF	Ø cm	H cm	
P710020	20	2,5	50
P710024	24	2,5	40
P710028	28	2,5	36

**P711 Fluted edge mould with removable base**  
*Molde rizado fondo desmontable*  
 Tourtière avec fond amovible



REF	Ø cm	H cm	
P711010	10	1,8	240
P711012	12	2,0	144
P711020	20	2,5	50
P711024	24	2,5	40
P711028	28	2,5	36
P711032	32	2,5	30

**P708 Savarin mould**  
*Molde savarin*  
 Moule savarin



REF	Ø cm	H cm	
P708008	8	2,0	1
P708022	22	4,5	1
P708024	24	5,0	1

**P712 "Trois frères" ring mould**  
*Molde savarin "trois frères"*  
 Moule savarin "trois frères"



REF	Ø cm	H cm	
P712022	22	5,5	1

## Non-stick moulds 6.3

Moldes antiadherentes  
Moules anti-adhésifs



**P713 Oval aspic mould**  
*Molde ovalado para aspic*  
 Moule aspic ovale



REF	cm	H cm	
P713075	7,5 x 5,5	3,8	240

**P717 Plain oval boat mould**  
*Molde barquita lisa*  
 Moule Barquette unie



REF	cm	H cm	
P717008	8 x 3,3	1,2	1
P717010	10 x 4,3	1,3	1

**P720 Round fluted tart mould**  
*Molde tartaleta acanalada redonda*  
 Moule tartelette ronde cannelée



REF	Ø cm	H cm	
P720005	5	1,2	576
P720006	6	1,2	576
P720007	7	1,2	1
P720008	8	1,2	432
P720010	10	1,8	240
P720012	12	2,0	144

**P722 60 "Petits fours" moulds set**  
*Caja de 60 pequeños moldes "Petits Fours"*  
 Boîte de 60 "petits fours"



**P715 Baba mould**  
*Molde redondo para bizcocho*  
 Baba rond

Rolled edge  
*Borde vuelto*  
 Bord roulé



REF	Ø cm	H cm	
P715006	6,5	6,0	192

**P718 10 Wide ribs brioche mould**  
*Molde madalenas con 10 costados*  
 Moule brioche 10 côtes



Ø 6: 9 ribs. Other ø: 10 ribs  
 Ø 6: 9 costados. Resto ø: 10 costados  
 Ø 6: 9 côtes. Autres ø: 10 côtes

REF	Ø cm	H cm	
P718006	6	2,5	432
P718008	8	3,2	240
P718010	10	3,8	240
P718011	11	4,0	1

**P721 Round plain tart mould**  
*Molde tartaleta redonda lisa*  
 Moule tartelette ronde unie



REF	Ø cm	H cm	
P721005	5	1,2	1
P721006	6	1,2	1
P721007	7	1,2	1
P721008	8	1,2	1
P721010	10	1,2	1

5 Pieces of each 12 "Petits fours".  
 5 Piezas de cada uno de los 12 "Petits fours".  
 5 Pièces de chacun des 12 "Petits fours".

REF	
P722000	1

## 6.4 Pastry cutter

Cortapastas  
Découpoirs



**P732 Set of 8 round plain cutters**  
Caja de 8 cortapastas redondos lisos  
Boîte de 8 découpoirs ronds unis



REF	Ø cm	H cm	
P732000	3 / 4 / 5 / 6 / 7 / 8 / 9 / 10	3,5	1

**P733 Set of 8 round fluted cutters**  
Caja de 8 cortapastas redondos rizados  
Boîte de 8 découpoirs ronds cannelés



REF	Ø cm	H cm	
P733000	3 / 4 / 5 / 6 / 7 / 8 / 9 / 10	3,5	1

**P796 9 pcs set polyglass plain cutters**  
Caja 9 cortapastas redondos lisos poliglas  
Boîte 9 découpoirs ronds unis polyglass



REF	Ø cm	H cm	
P796000	2 / 3 / 4 / 5 / 6 / 7 / 8 / 9 / 10	3,5	1

**P7961 9 pcs set polyglass fluted cutters**  
Caja 9 cortapastas redondos rizados poliglas  
Boîte 9 découpoirs ronds cannelés polyglass



REF	Ø cm	H cm	
P796100	2 / 3 / 4 / 5 / 6 / 7 / 8 / 9 / 10	3,5	1

## St/steel pastry moulds 6.5

Moldes acero inoxidable  
Moules en acier inox



**P780 Tart ring**  
Aro redondo para tarta  
Cercle à tarte



REF	Ø cm	H cm	
P780006	6	2	1
P780008	8	2	100
P780010	10	2	100

**P781 "Entremets" ring**  
Aro redondo para tarta  
Cercle à entremets



REF	Ø cm	H cm	
P781006	6	3,5	100
P781008	8	3,5	100
P781010	10	3,5	100

**P782 Mousse ring**  
Aro redondo para mousse  
Cercle à mousse



REF	Ø cm	H cm	
P782075	7,5	4,0	100
P782008	8,0	4,5	1
P782010	10,0	4,5	100
P782012	12,0	4,5	1
P782014	14,0	4,5	1
P782016	16,0	4,5	50
P782018	18,0	4,5	50
P782020	20,0	4,5	20
P782022	22,0	4,5	20
P782024	24,0	4,5	20
P782026	26,0	4,5	20
P782028	28,0	4,5	20

**P783 Ice cream cake ring**  
Aro redondo para tarta  
Cercle à vacherin



REF	Ø cm	H cm	
P783006	6	6	100
P783008	8	6	100
P783010	10	6	50
P783012	12	6	1
P783014	14	6	50
P783016	16	6	50
P783018	18	6	50
P783020	20	6	20
P783022	22	6	20
P783024	24	6	20
P783026	26	6	20
P783028	28	6	20
P783030	30	6	6

**P785 Mousse ring**  
Aro redondo para mousse  
Cercle à mousse



REF	Ø cm	H cm	
P785006	6	4	100
P785008	8	4	100
P785010	10	4	100



**Perfect for dishes presentation**  
Perfecto para presentación de platos  
Idéal pour la présentation de plats

## 6.5 St/steel pastry moulds

Moldes acero inoxidable  
Moules en acier inox

### P765 Hexagon

Molde hexagonal  
Hexagone

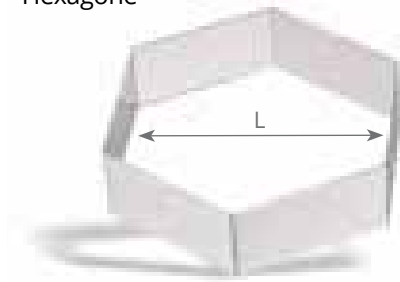

REF	L cm	H cm	
P765020	20	4,5	1
P765024	24	4,5	1

### P768 Tear

Molde forma lágrima  
Larme



REF	L cm	H cm	
P768006	6	4,5	1
P768008	8	4,5	1

### P771 Oval

Molde forma oval  
Ovale

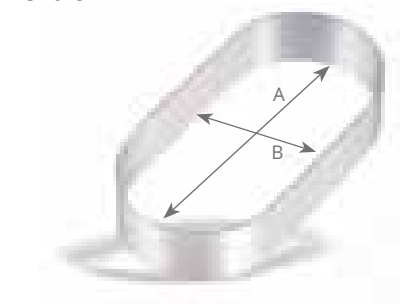

REF	L cm	H cm	
P771025	25 x 11,2	4,5	1

### P769 Heart

Molde forma corazón  
Coeur

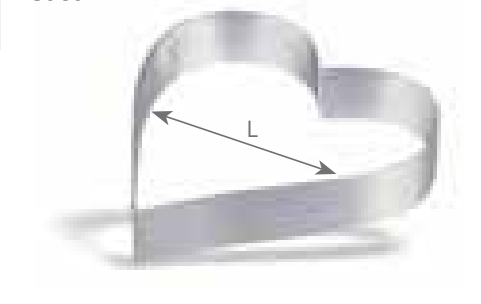

REF	L cm	H cm	
P769008	8	4,5	48
P769010	10	4,5	72
P769018	18	4,5	1
P769020	20	4,5	36
P769022	22	4,5	1

### P992 PVC ribbon for mousse

Cinta PVC para mousse  
Ruban pâtissier en PVC



REF	Length Longitud Longueur	H cm	
P992040	100 m	4,0	1
P992045	100 m	4,5	1
P992050	100 m	5,0	1

See products on / Ver productos en / Voir produits en page

P. 107

### Fine tip straight tweezer

Pinza chef precisión  
Pince du chef précision



## St/steel pastry moulds 6.5

Moldes acero inoxidable  
Moules en acier inox

### P355 Caramel cream mould

Flanero  
Moule à flan



REF	Ø cm	H cm	Lts	
P355007	7,5	5,2	0,12	288
P355008	8,5	5,4	0,17	288

### P136 Reinforced caramel cream mould

Molde industrial para flan  
Moule à flan



REF	Ø cm	H cm	Lts	
P136006	6	5,5	0,10	1
P136007	7	6,5	0,15	1
P136008	8	6,5	0,25	1

### P789 Round cake mould

Molde 1/2 caña desmontable redondo  
Gouttière ronde



REF	W x D x H cm	
P789025	25 x 9 x 6	1
P789050	50,5 x 9 x 9	1

### P788 Triangle cake mould

Molde 1/2 caña desmontable triangular  
Gouttière triangulaire



REF	W x D x H cm	
P788025	25 x 9 x 6	1
P788050	50 x 9 x 6	1

### P784 Cake mould

Molde cake  
Moule à cake

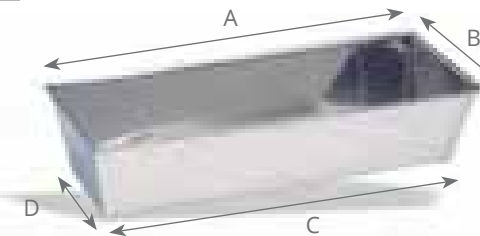

REF	A x B cm	C x D cm	H cm	
P784020	20 x 13	18,0 x 10	8	50
P784025	25 x 13	22,0 x 10	8	50
P784030	30 x 13	27,0 x 10	8	25
P784035	35 x 13	32,0 x 10	8	1
P784040	40 x 13	36,5 x 10	8	1

## 6.6 Bags and tubes

Mangas y boquillas  
Poches et douilles



### P800 Nylon pastry bags

Mangas de nylon  
Poches pâtisseries en nylon



REF	cm	Ø cm	
P800030	30	17,0	1
P800035	35	19,5	1
P800040	40	22,0	1
P800045	45	25,0	1
P800050	50	27,5	1
P800055	55	30,5	1
P800060	60	33,0	1
P800065	65	35,0	1
P800070	70	39,0	1

Made in nylon and covered with polyurethane on one side. Waterproof, ultra light and very comfortable to use. Sterizable, without seams, thermowelded for long life and with an adjustable end.

Fabricadas en nylon y recubiertas de poliuretano por una cara. Impermeables y ultraligeras. Son muy cómodas de utilizar. Se pueden hervir. Sin costuras, termosoldadas de larga duración y con la punta ajustable.

Fabriquéées en tissu de nylon avec un revêtement polyuréthane sur une face. Impérmeables, très souples, ultralégères et très comodes au tact. Stérilisables, sans coutures, thermosoudées, de longue durée et avec l'embout ajustable.

### P798 Disposable pastry bags

Mangas desechables  
Poches jetables



REF	cm	Lts	
P798040	43	2,00	10
P798055	55	3,50	10
P798065	65	5,00	10

VOLLRATH

### P851 Cotton pastry bag

Manga pastelera de algodón  
Poches pâtisseries en cotton



REF	L cm	
P851040	40	1
P851046	46	1
P851050	50	1

### P849 Support for pastry bags and tubes (nozzles)

Soporte para mangas pasteleras y boquillas  
Support pour pochés pâtisseries et douilles



REF	
P849000	1

### P798056 Green disposable pastry bags

Mangas desechables color verde  
Poches jetables verdes

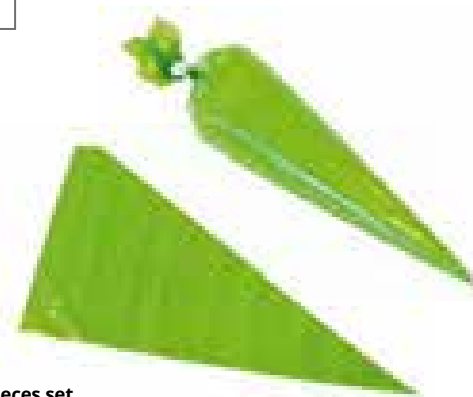

100 pieces set  
Caja de 100 unidades  
Boîte de 100 pièces

REF	cm	Lts	
P798056	55	3,50	1

170

pujadas

## Bags and tubes 6.6

Mangas y boquillas  
Poches et douilles



### P810 Plain tube

Boquilla redonda  
Douille unie



REF	Ø cm	
P810004	0,4	500
P810006	0,6	500
P810008	0,8	500
P810010	1,0	500
P810012	1,2	500
P810014	1,4	500

### P811 Star tube

Boquilla estrella  
Douille cannelée



REF	Ø cm	N° Teeth / N° Puntas / N° Dents	
P811004	0,4	6	500
P811006	0,6	6	500
P811008	0,8	6	500
P811010	1,0	7	500
P811012	1,2	7	500
P811014	1,4	8	500
P811016	1,6	9	500

### P812 Closed star tube

Boquilla estrella cerrada  
Douille cannelée fermée



REF	Ø cm	N° Teeth / N° Puntas / N° Dents	
P812003	0,3	6	500
P812005	0,5	6	500
P812007	0,7	6	500
P812009	0,9	8	500
P812011	1,1	8	500

### P813 Yule log tube

Boquilla cinta estrella  
Douille à bûche de Noël



REF	cm	N° Teeth / N° Puntas / N° Dents	
P813016	1,6 x 0,2	6	500
P813020	2,0 x 0,3	6	500

### P816 Flower tube

Boquilla flor  
Douille fleur

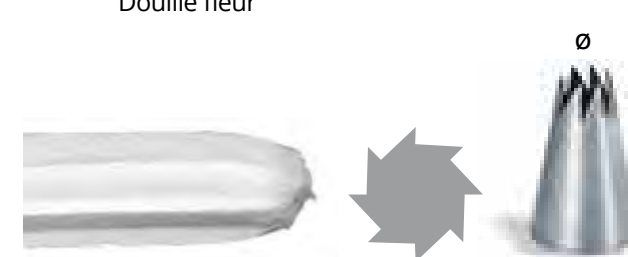

REF	Ø cm	N° Teeth / N° Puntas / N° Dents	
P816011	1,1	6	500

### P817 Closed flower tube

Boquilla flor cerrada  
Douille fleur fermée



REF	Ø cm	N° Teeth / N° Puntas / N° Dents	
P817005	0,5	6	500
P817006	0,6	8	500
P817008	0,8	9	500

VOLLRATH

171

pujadas

## 6.6 Bags and tubes

Mangas y boquillas  
Poches et douilles



### P815 "petits fours" tube Boquilla rizada Douille à "petits fours"

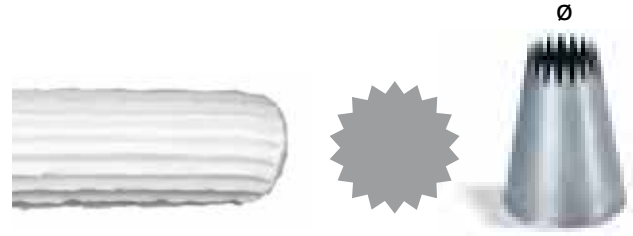

REF	Ø cm	N° Teeth / N° Puntas / N° Dents	1
P815006	0,6	9	500
P815009	0,9	12	500
P815012	1,2	15	500
P815015	1,5	16	500

### P820 Set of 6 tubes nr. 0 Conjunto de 6 boquillas n° 0 Boîte de 6 douilles num. 0

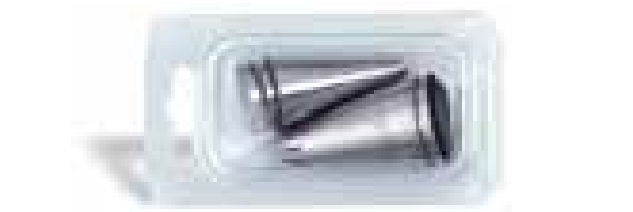

REF	1
P820000	1

Diameter exit holes of the tubes are drawn at real size.  
Los gráficos de los diámetros de los agujeros de salida de las boquillas son a tamaño real.  
Les graphiques des diamètres des embouts de sortie des douilles sont en taille réelle.

- 1 Plain tube 0,4 cm**  
1 Boquilla redonda 0,4 cm  
1 Douille unie 0,4 cm
- 1 Star tube 0,8 cm**  
1 Boquilla estrella 0,8 cm  
1 Douille cannelée 0,8 cm
- 1 Plain tube 0,8 cm**  
1 Boquilla redonda 0,8 cm  
1 Douille unie 0,8 cm
- 1 Star tube 1,2 cm**  
1 Boquilla estrella 1,2 cm  
1 Douille cannelée 1,2 cm
- 1 Flower tube 1,1 cm**  
1 Boquilla flor 1,1 cm  
1 Douille fleur 1,1 cm
- 1 Yule log 2 x 0,3 cm**  
1 Boquilla cinta estrella 2 x 0,3 cm  
1 Douille à bûche de Noël 2 x 0,3 cm

### P814 Bismark tube Boquilla para relleno Douille petit chou

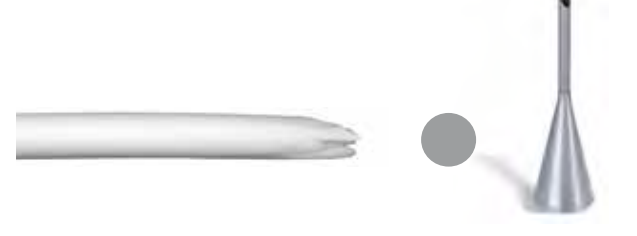

REF	Ø cm	25
P814000	0,4	25

### P821 Set of 6 tubes nr. 1 Conjunto de 6 boquillas n° 1 Boîte de 6 douilles num. 1

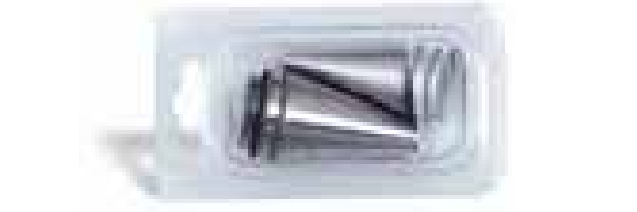

REF	1
P821000	1

Diameter exit holes of the tubes are drawn at real size.  
Los gráficos de los diámetros de los agujeros de salida de las boquillas son a tamaño real.  
Les graphiques des diamètres des embouts de sortie des douilles sont en taille réelle.

- 1 Plain tube 0,2 cm**  
1 Boquilla redonda 0,2 cm  
1 Douille unie 0,2 cm
- 1 Plain tube 0,4 cm**  
1 Boquilla redonda 0,4 cm  
1 Douille unie 0,4 cm
- 1 Plain tube 0,6 cm**  
1 Boquilla redonda 0,6 cm  
1 Douille unie 0,6 cm
- 1 Plain tube 0,8 cm**  
1 Boquilla redonda 0,8 cm  
1 Douille unie 0,8 cm
- 1 Plain tube 1 cm**  
1 Boquilla redonda 1 cm  
1 Douille unie 1 cm
- 1 Plain tube 1,2 cm**  
1 Boquilla redonda 1,2 cm  
1 Douille unie 1,2 cm

## Bags and tubes 6.6

Mangas y boquillas  
Poches et douilles



### P822 Set of 6 tubes nr. 2 Conjunto de 6 boquillas n° 2 Boîte de 6 douilles num. 2



REF	1
P822000	1

Diameter exit holes of the tubes are drawn at real size.  
Los gráficos de los diámetros de los agujeros de salida de las boquillas son a tamaño real.  
Les graphiques des diamètres des embouts de sortie des douilles sont en taille réelle.

- 1 Star tube 0,2 cm**  
1 Boquilla estrella 0,2 cm  
1 Douille cannelée 0,2 cm
- 1 Star tube 0,4 cm**  
1 Boquilla estrella 0,4 cm  
1 Douille cannelée 0,4 cm
- 1 Star tube 0,6 cm**  
1 Boquilla estrella 0,6 cm  
1 Douille cannelée 0,6 cm
- 1 Star tube 0,8 cm**  
1 Boquilla estrella 0,8 cm  
1 Douille cannelée 0,8 cm
- 1 Star tube 1 cm**  
1 Boquilla estrella 1 cm  
1 Douille cannelée 1 cm
- 1 Star tube 1,2 cm**  
1 Boquilla estrella 1,2 cm  
1 Douille cannelée 1,2 cm

### P822 Set of 6 tubes nr. 3 Conjunto de 6 boquillas n° 3 Boîte de 6 douilles num. 3

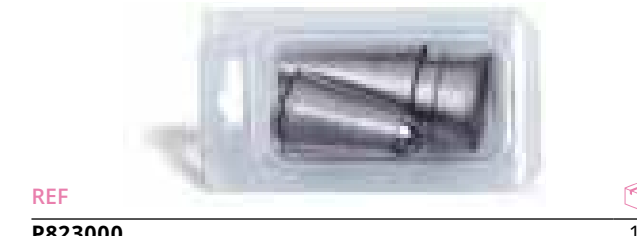

REF	1
P823000	1

Diameter exit holes of the tubes are drawn at real size.  
Los gráficos de los diámetros de los agujeros de salida de las boquillas son a tamaño real.  
Les graphiques des diamètres des embouts de sortie des douilles sont en taille réelle.

- 1 Closed flower tube 0,6 cm**  
1 Boquilla flor cerrada 0,6 cm  
1 Douille fleur fermée 0,6 cm
- 1 Closed star tube 0,7 cm**  
1 Boquilla estrella cerrada 0,7 cm  
1 Douille cannelée fermée 0,7 cm
- 1 Star tube 0,8 cm**  
1 Boquilla estrella 0,8 cm  
1 Douille cannelée 0,8 cm
- 1 Plain tube 1 cm**  
1 Boquilla redonda 1 cm  
1 Douille unie 1 cm
- 1 "Petits fours" tube 1,2 cm**  
1 Boquilla rizada 1,2 cm  
1 Douille à "petits fours" 1,2 cm
- 1 Flower tube 1,3 cm**  
1 Boquilla flor 1,3 cm  
1 Douille fleur 1,3 cm

### P824 Set of 12 tubes nr. 4 Conjunto de 12 boquillas n° 4 Boîte de 12 douilles num. 4

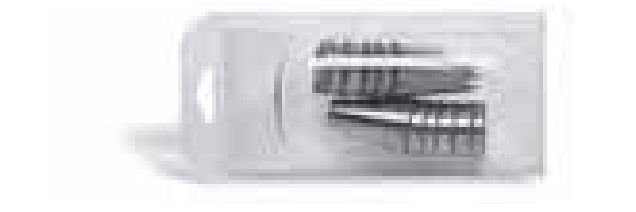

REF	1
P824000	1

Diameter exit holes of the tubes are drawn at real size.  
Los gráficos de los diámetros de los agujeros de salida de las boquillas son a tamaño real.  
Les graphiques des diamètres des embouts de sortie des douilles sont en taille réelle.

- 1 Plain tube 0,6 cm**  
1 Boquilla redonda 0,6 cm  
1 Douille unie 0,6 cm
- 1 Closed star tube 0,7 mm**  
1 Boquilla estrella cerrada 0,7 mm  
1 Douille cannelée fermée 0,7 mm
- 1 Plain tube 1 cm**  
1 Boquilla redonda 1 cm  
1 Douille unie 1 cm
- 1 Closed star tube 1,1 mm**  
1 Boquilla estrella cerrada 1,1 mm  
1 Douille cannelée fermée 1,1 mm
- 1 Star tube 0,8 cm**  
1 Boquilla estrella 0,8 cm  
1 Douille cannelée 0,8 cm
- 1 Yule log tube 2 mm**  
1 Boquilla cinta estrella 2 mm  
1 Douille à bûche de Noël 2 mm
- 1 Star tube 1,2 cm**  
1 Boquilla estrella 1,2 cm  
1 Douille cannelée 1,2 cm
- 1 "Petits fours" tube 0,9 mm**  
1 Boquilla rizada 0,9 mm  
1 Douille à "petits fours" 0,9 mm
- 1 "Petits fours" tube 1,5 cm**  
1 Boquilla rizada 1,5 cm  
1 Douille à "petits fours" 1,5 cm
- 1 Flower tube 1,1 cm**  
1 Boquilla flor 1,1 cm  
1 Douille fleur 1,1 cm
- 1 Flower tube 1,5 cm**  
1 Boquilla flor 1,5 cm  
1 Douille fleur 1,5 cm
- 1 Closed flower tube 0,8 cm**  
1 Boquilla flor cerrada 0,8 cm  
1 Douille fleur fermée 0,8 cm



## 6.6 Bags and tubes

Mangas y boquillas  
Poches et douilles



**P853 Polycarbonate plain tube**  
Boquilla redonda de policarbonato  
Douille unie en polycarbonate



REF	Ø cm	Num.	
P853004	0,4	0	1
P853006	0,6	2	1
P853008	0,8	4	1
P853010	1,0	6	1
P853012	1,2	8	1
P853014	1,4	10	1

**P854 Polycarbonate star tube**  
Boquilla estrella de policarbonato  
Douille cannelée en polycarbonate



REF	Ø cm	Nº Teeth Nº Puntas Nº Dents	Num.	
P854006	0,6	7	2	1
P854008	0,8	7	4	1
P854010	1,0	7	6	1
P854012	1,2	7	8	1
P854014	1,4	8	10	1
P854016	1,6	8	12	1

**P855 Set of 6 polycarbonate tubes nº 5**  
Conjunto de 6 boquillas de policarbonato nº 5  
Boîte de 6 douilles en polycarbonate nº 5

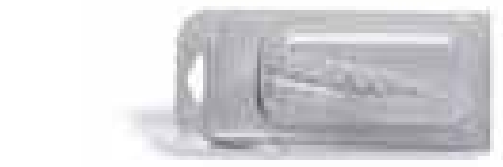

**Plain tube**  
Boquilla redonda  
Douille unie

REF	
P855000	1

Nº 0	Nº 2	Nº 4	Nº 6	Nº 8	Nº 10
0,4 cm	0,6 cm	0,8 cm	1 cm	1,2 cm	1,4 cm



**P857 Set of 12 polycarbonate tubes nº 12**  
Conjunto de 12 boquillas de policarbonato nº 12  
Boîte de 12 douilles en polycarbonate nº 12

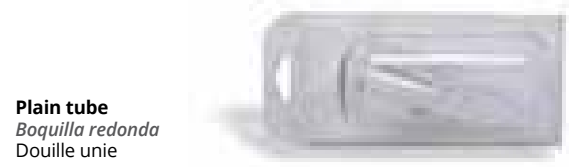

**Plain tube**  
Boquilla redonda  
Douille unie

Nº 0	Nº 2	Nº 4	Nº 6	Nº 8	Nº 10
0,4 cm	0,6 cm	0,8 cm	1 cm	1,2 cm	1,4 cm



**P856 Set of 6 polycarbonate tubes nº 6**  
Conjunto de 6 boquillas de policarbonato nº 6  
Boîte de 6 douilles en polycarbonate nº 6

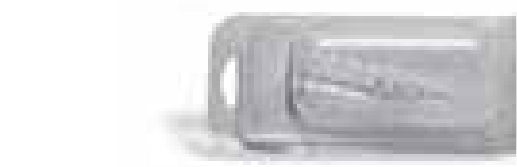

**Star tube**  
Boquilla estrella  
Douille cannelée

REF	
P856000	1

Nº 2	Nº 4	Nº 6	Nº 8	Nº 10	Nº 12
0,6 cm	0,8 cm	1 cm	1,2 cm	1,4 cm	1,6 cm



REF	
P857000	1

**Star tube**  
Boquilla estrella  
Douille cannelée

Nº 2	Nº 4	Nº 6	Nº 8	Nº 10	Nº 12
0,6 cm	0,8 cm	1 cm	1,2 cm	1,4 cm	1,6 cm



## Flexipan moulds 6.7

Moldes flexipan  
Moules flexipan



# FLEXIPAN® ORIGINE



The Flexipan® is a silicone and fibre glass combination mould suitable for the food contact.

This material combination gives to the piece solidity and an extraordinary durability, allied with exceptional non-stick properties either for cooking and freezing.

The Flexipan® does not require to be lubricated since their composition and flexibility allow an easy and fast release from the mould.

According to the use and the maintenance, the Flexipan®, enable us to use them between 2000 and 3000 times before the first signs of sticking arise.

The FLEXIPAN can be used to bake (+280 °C) or freeze (-40 °C) the most sweet and savoury products.

- ADVANTAGES FLEXIPAN®**
- No need to be greased for an easy and quick realise
  - Easy to clean
  - Between 2000 and 3000 times can be used
  - Professional pastry measures (60x40 cm)
  - Large range of moulds

El Flexipan® es una combinación de fibras de vidrio y sílica adecuadas para el uso alimentario.

Esta combinación de materiales le da a la pieza una solidez y duración de vida inigualables, así como propiedades anti-adherentes excepcionales tanto en cocción como en congelación.

El Flexipan® no requiere ser engrasado ya que su composición y flexibilidad permiten un desmoldeo fácil y rápido.

El Flexipan® con un uso y trato correctos nos permite realizar entre 2.000 y 3.000 cocciones antes de empezar a notar los primeros signos de deterioro.

El Flexipan® permite realizar cualquier tipo de preparaciones dulces o saladas, tanto en cocción (+280 °C) como en congelación (-40 °C).

- VENTAJAS FLEXIPAN®**
- No es necesario engrasar los moldes para obtener un desmoldeo perfecto
  - Gran facilidad para el desmoldeo de piezas congeladas
  - La limpieza de los moldes se realiza de una manera fácil y rápida
  - Larga vida de la pieza (2.000-3.000 cocciones)
  - Medidas para pastelería profesional (60x40 cm)
  - Gama completa de formas.

Le Flexipan® est une combinaison de tissus de verre et silicines adéquats pour l'utilisation alimentaire.

Cette combinaison de matériels donne au moule une solidité et une durabilité extraordinaire, alliées à des propriétés anti-adhérentes exceptionnelles tant en cuisson comme en congélation.

Le Flexipan® n'a pas besoin d'être lubrifié puisque sa composition et flexibilité permettent un démolage facile et rapide.

Selon l'utilisation et l'entretien des moules, le Flexipan®, nous permet d'effectuer entre 2.000 et 3.000 cuissons avant de noter les premiers signes de collage.

Le Flexipan® permet d'effectuer tous types de préparations sucrées ou salées, en cuisson (+ 280 °C) ou en congélation (-40 °C).

- AVANTAGES FLEXIPAN®**
- Ne précise d'aucun graissage pour un démolage facile et rapide
  - Facile à nettoyer
  - De 2000 à 3000 cuissons par moule
  - Mesures pour la pâtisserie professionnelle (60x40 cm)
  - Large gamme de moules

Sizes  
Medidas  
Mesures

Pastry / Pastelería /  
Pâtisserie

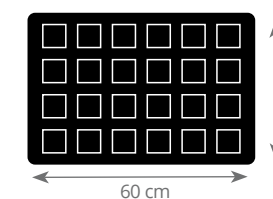

-40 °C / -104 °F  
+280 °C / +539 °F



H.A.C.C.P.  
NO PROBLEM

## 6.7 Flexipan moulds

Moldes flexipan  
Moules flexipan



### Cones / Conos / Cones



REF	Forma	Fig	Ø cm	H cm	ml	
P859134		40	5	4	24	1
P859135		20	7	6	80	1

### Rosace shape / Bavaois / Bavaois



REF	Forma	Fig	Ø cm	H cm	ml	
P859139		18	7,8	3,5	100	1

### Charlottes

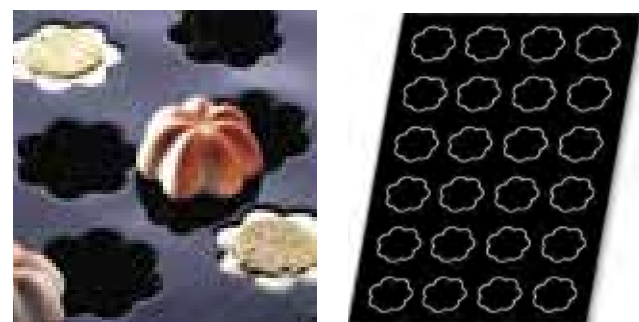

REF	Forma	Fig	Ø cm	H cm	ml	
P859141		24	6,2	3,5	60	1
P859113		18	7,8	4,0	100	1

### Madeleines/ Magdalenas / Madeleines

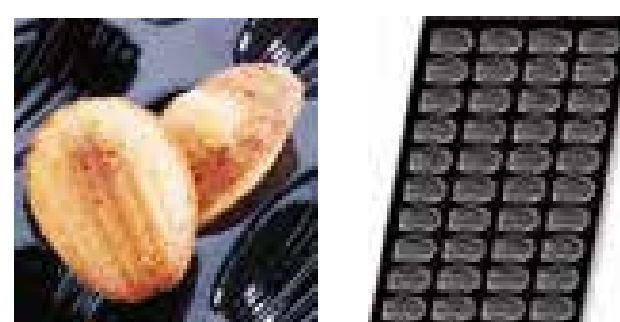

REF	Forma	Fig	cm	H cm	ml	
P859142		56	5,2 x 3,3	1,5	15	1
P859115		40	7,8 x 4,7	1,9	35	1

### Saint Jacques shell / Conchas / Coquilles Saint-Jacques

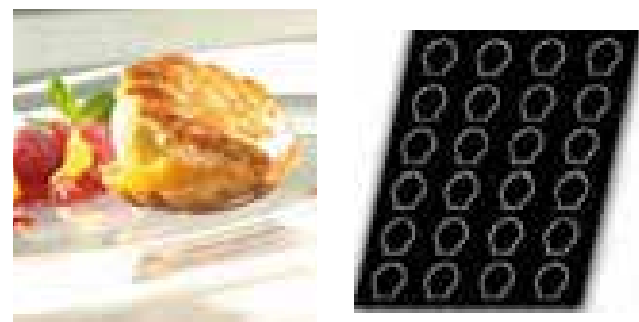

REF	Forma	Fig	cm	H cm	ml	
P859132		24	8 x 7,5	2	70	1

### Deep flower / Margaritas / Marguerites en relief

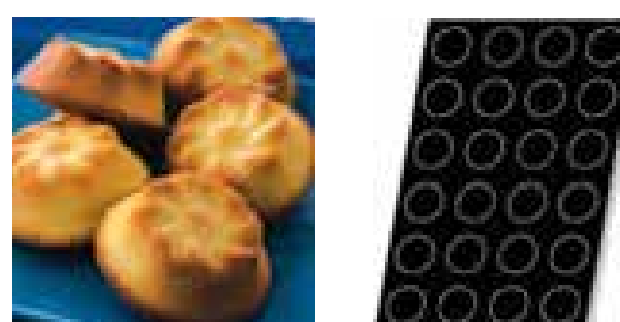

REF	Forma	Fig	Ø cm	H cm	ml	
P859143		24	2,4	7	70	1

## Flexipan moulds 6.7

Moldes flexipan  
Moules flexipan



### Flowers / Flores / Fleurs



REF	Forma	Fig	Ø cm	H cm	ml	
P859144		24	7,8	2	80	1

### Pyramids / Pirámides / Pyramides

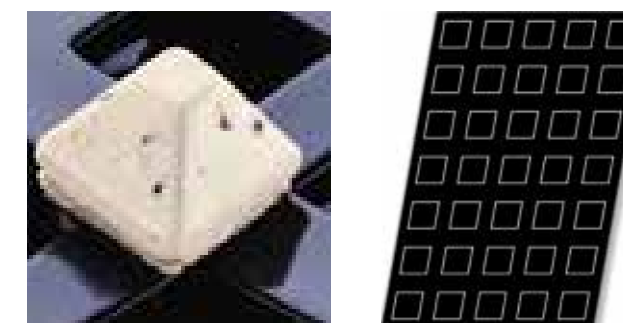

REF	Forma	Fig	cm	H cm	ml	
P859109		54	3,5 x 3,5	2,3	15	1
P859111		35	5,0 x 5,0	3,5	35	1
P859110		24	7,1 x 7,1	4,1	90	1

### Half-spheres / Semi-esferas / Demi-sphères



REF	Forma	Fig	Ø cm	H cm	ml	
P859151		96	2,6	1,6	6	1
P859105		70	2,9	1,8	10	1
P859103		48	4,2	2,1	20	1
P859102		28	5,8	3,1	50	1
P859101		24	7,0	4,0	105	1
P859104		24	8,0	4,0	126	1

### Half-spheres upside down / Semi-esferas invertidas / Demi-sphères inversées



REF	Forma	Fig	Ø cm	H cm	ml	
P859150		45	2,6	1,6	6	1

### Squares / Cuadrados / Carrés

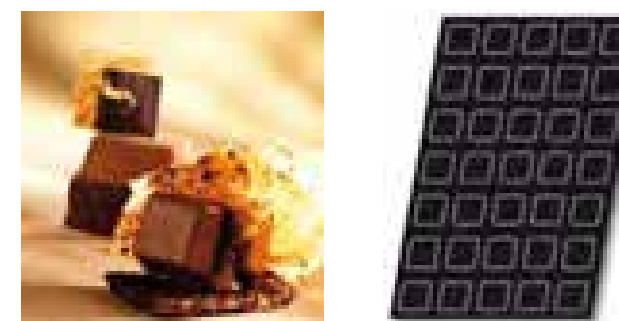

REF	Forma	Fig	cm	H cm	ml	
P859152		60	3,7 x 3,7	1,7	18	1
P859153		35	5,6 x 5,6	2,4	60	1

### Square tartlet / Tartaletas cuadradas / Tartelettes carrées

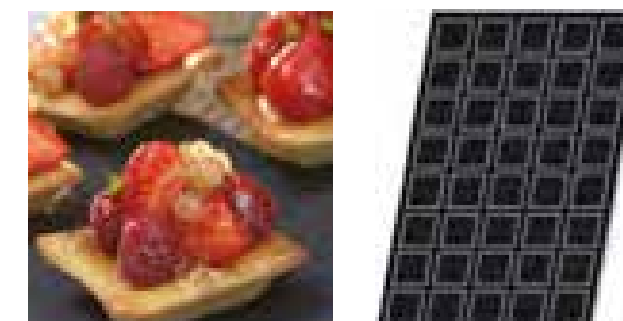

REF	Forma	Fig	cm	H cm	ml	
P859154		60	4,5 x 4,5	1,2	20	1
P859155		40	6,0 x 6,0	1,5	40	1

## 6.7 Flexipan moulds

Moldes flexipan  
Moules flexipan



### Square savarins / Savarins cuadradas

Savarins carrées



REF	Forma	Fig	cm	H cm	ml	
P859156		60	3,7 x 3,7	1,7	15	1
P859157		35	5,6 x 5,6	2,4	45	1
P859158		24	7,0 x 7,0	3,0	100	1

### Round savarins / Savarins redondos / Savarins ronds

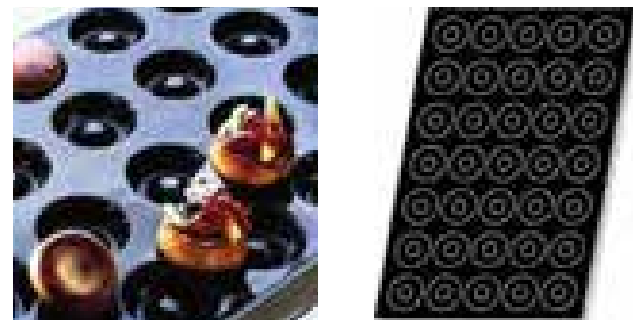

REF	Forma	Fig	Ø cm	H cm	ml	
P859159		60	4,1	1,2	10	1
P859124		35	6,6	2,0	50	1
P859219		24	7,0	2,3	65	1
P859122		24	8,0	2,0	70	1

### Oval savarins / Savarins ovalados / Savarins ovales



REF	Forma	Fig	cm	H cm	ml	
P859123		24	8 x 6	2,5	70	1

### Oval / Óvalos / Ovales

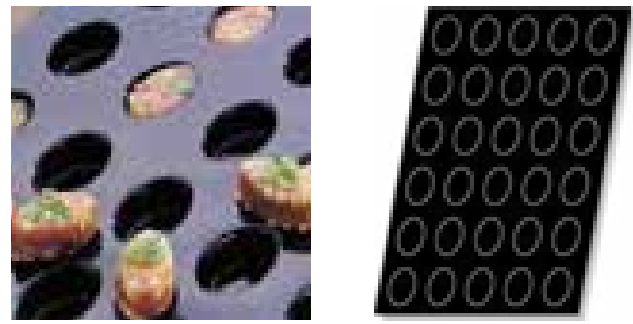

REF	Forma	Fig	cm	H cm	ml	
P859167		30	7,0 x 5,0	3	25	1
P859130		30	8,5 x 6,0	3	100	1

### Round tartlets / Tartaletas redondas /

Tartelettes ronds

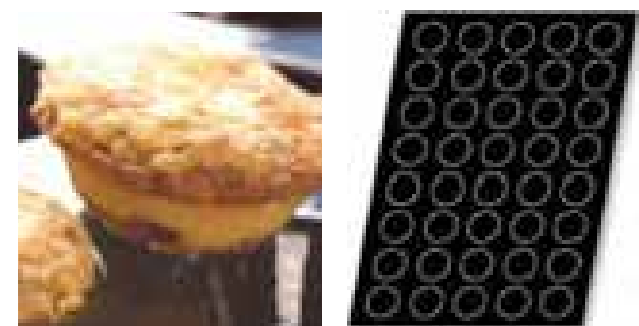

REF	Forma	Fig	Ø cm	H cm	ml	
P859114		60	42	10,0	13	1
P859171		48	48	15,0	20	1
P859172		40	58	20,0	35	1
P859126		24	77	20,0	65	1

### Logs / Troncos / Bûche

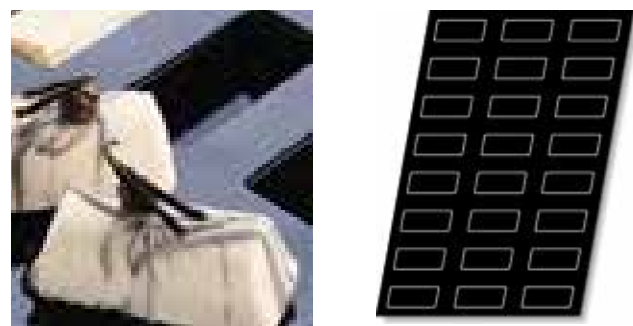

REF	Forma	Fig	cm	H cm	ml	
P859125		24	9,50 x 4	3,0	80	1
P859184		8	33,9 x 4	3,9	450	1
P859185		5	49,5 x 4	3,9	700	1

## Flexipan moulds 6.7

Moldes flexipan  
Moules flexipan



### Cakes-Lady fingers / Cakes/Bizcochos / Cakes-Coudoirs

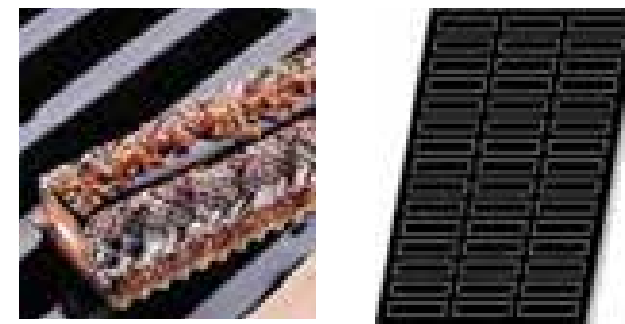

REF	Forma	Fig	cm	H cm	ml	
P859186		120	4,0 x 1,5	1,2	6	1

### Lingots / Lingotes / Lingots



REF	Forma	Fig	cm	H cm	ml	
P859189		24	10 x 4	2,5	70	1
P859190		24	12 x 4	2,5	90	1

### Half-Cylindres / Semi-cilindros / Demi-cylindres



REF	Forma	Fig	cm	H cm	ml	
P859191		48	8,5 x 1,7	1,5	20	1

### Cakes

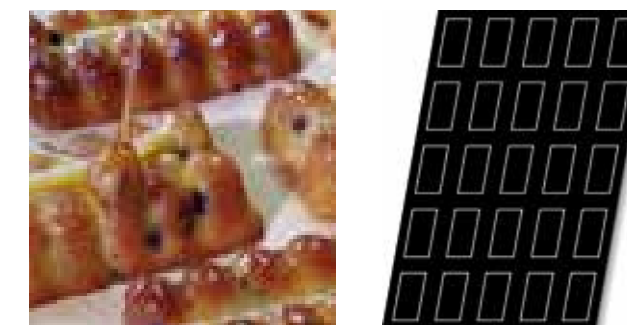

REF	Forma	Fig	cm	H cm	ml	
P859192		24	8 x 3	3,0	55	1
P859195		16	11 x 6	2,5	105	1

### Financiers



REF	Forma	Fig	cm	H cm	ml	
P859196		84	5,0 x 2,6	11	10	1
P859197		24	8,6 x 4,6	14	45	1

### Muffins



REF	Forma	Fig	Ø cm	H cm	ml	
P859106		40	5,1	2,9	45	1
P859107		24	7,3	4,0	125	1
P859198		15	8,2	5,0	220	1

## 6.7 Flexipan moulds

Moldes flexipan  
Moules flexipan



### Cylinders / Cilindros / Cylindres

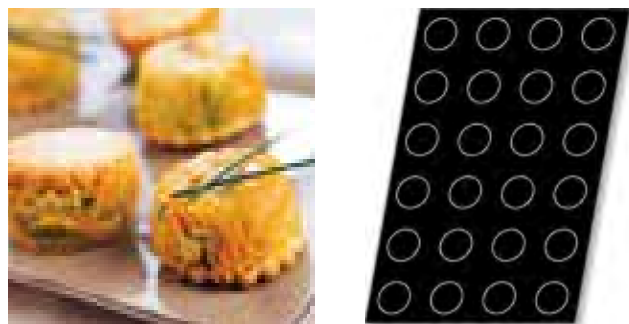

REF	Forma	Fig	Ø cm	H cm	ml	
P859206		48	4,0	2,0	25	1
P859207		24	6,3	2,5	65	1
P859117		24	6,3	3,5	90	1

### Florentiners / Florentina / Florentins

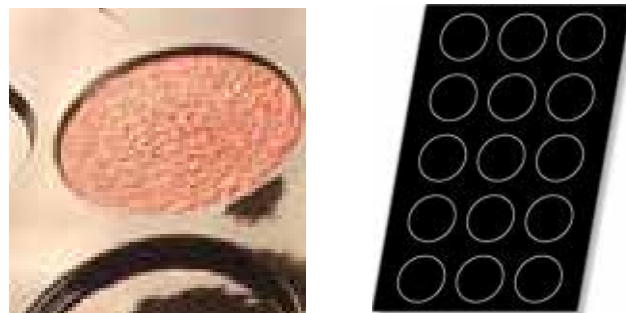

REF	Forma	Fig	Ø cm	H cm	ml	
P859129		15	10,2	2	140	1

### Tatin apple tarts / Tartas tatin / Tartes tatin

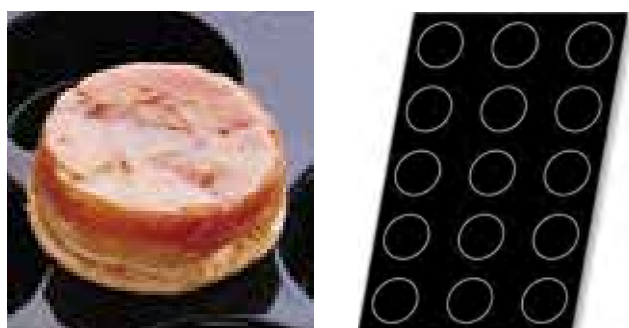

REF	Forma	Fig	Ø cm	H cm	ml	
P859210		15	8,20	3,0	135	1
P859211		12	10,0	3,5	245	1
P859212		12	10,5	4,0	305	1

### Round-Pizza-Quiches / Entremets-Pizzas-Quiches / Empreintes rondes-Pizza-Quiches

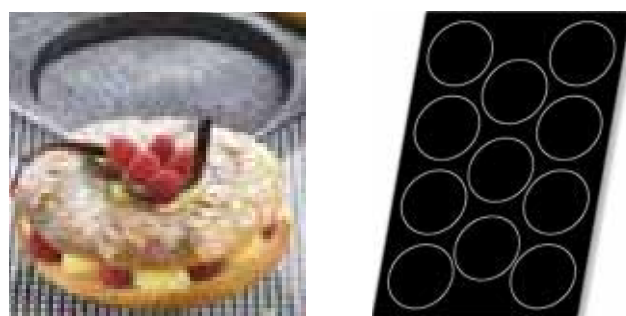

REF	Forma	Fig	Ø cm	H cm	ml	
P859116		6	18,6	1,2	300	1

### Mini-brioches / Lanzaderas / Navettes



REF	Forma	Fig	cm	H cm	ml	
P859200		48	7 x 3	1	15	1

### Long / Alargadas / Longues



REF	Forma	Fig	cm	H cm	ml	
P859201		24	13 x 4,8	1,8	80	1



## Flexipan moulds 6.7

Moldes flexipan  
Moules flexipan

### Rounds / Redondas / Ronds

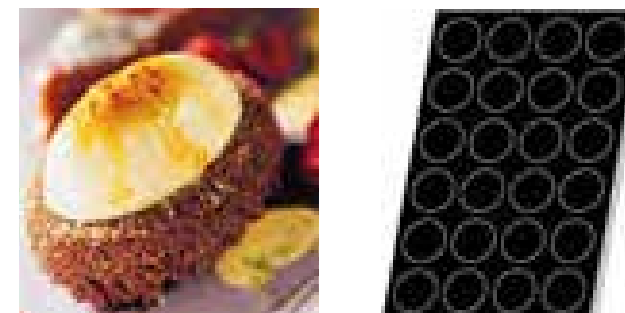

REF	Forma	Fig	Ø cm	H cm	ml	
P859202		24	7,9	1,5	65	1

### Flowers / Flores / Fleurs

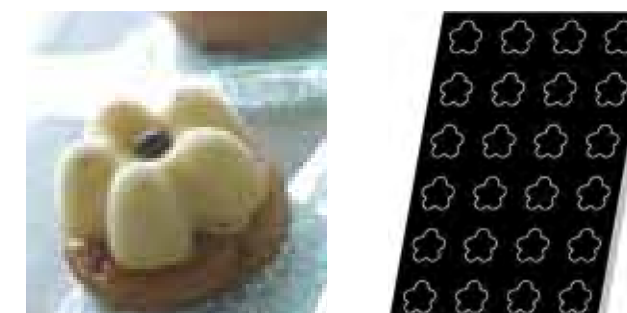

REF	Forma	Fig	cm	H cm	ml	
P859203		24	6,2 x 4,9	2,6	60	1

### Cannelées / Acanalda

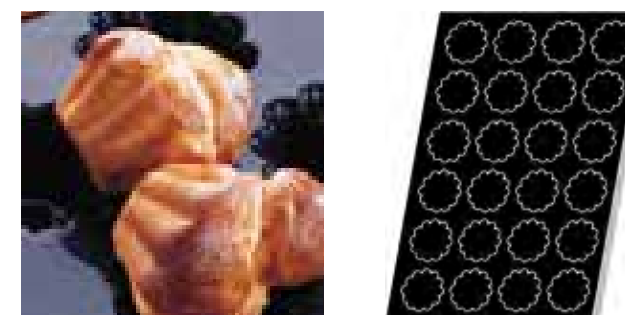

REF	Forma	Fig	Ø cm	H cm	ml	
P859204		24	6,8	2,5	60	1
P859205		24	7,8	3,0	105	1

### Octagons / Octágonos / Octogones



REF	Forma	Fig	Ø cm	H cm	ml	
P859119		40	4,3 x 4	2,6	28	1

### Pomponnettes



REF	Forma	Fig	Ø cm	H cm	ml	
P859120		96	3,6	1,7	14	1

# 6.8 Silicone moulds

Moldes silicona  
Moules silicone



**P8504** Cake mould  
Molde cake  
Moule à cake



REF	W x D x H cm	Fig
P850424	24 x 10,5 x 6,5	1
P850426	26 x 10 x 7	1

**P8502** Gugelhoph  
Molde savarin alto  
Moule savarin haut



New shape  
Nueva forma  
Nouvelle forme

REF	Ø cm	H cm	Fig
P850222	22,5	11,5	12

**P8501** High cake mould  
Molde tarta  
Manqué rond uni



REF	Ø cm	H cm	Fig
P850124	24	4,2	1
P850128	28	4,7	1

**P8505** Round tart mould with fluted edges  
Molde rizado para tarta  
Tourtière ronde avec bord cannelé



New shape  
Nueva forma  
Nouvelle forme

REF	Ø cm	H cm	Fig
P850528	28	3	12

Medidas  
Sizes  
Mesures

GN 1/3

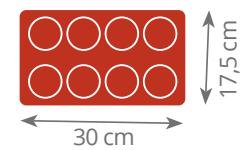

GN 1/1

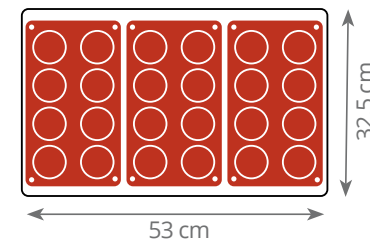

Pastry / Pastelería / Pâtisserie

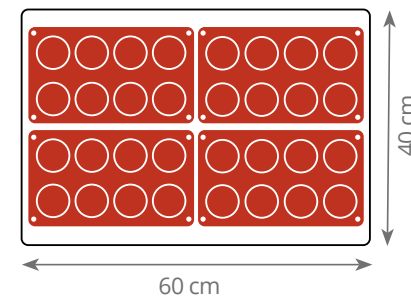

**Si** Silicone  
**100%** Flexibility  
Flexibilidad  
Flexibilité



Ideal for freezing. It can also be used for all preparations of cakes, chocolates, petit-fours, and catering preparations.  
Ideal para congelador. Puede ser utilizado para preparar todo tipo de pequeña repostería, galletas o chocolates.  
Idéal pour la congélation. Utilisable pour tout type de préparations de cakes, chocolats, petits fours, et préparations traiteurs.

-60 °C / - 140 °F  
+230 °C / + 446 °F



H.A.C.C.P.  
NO PROBLEM

# Silicone moulds 6.8

Moldes silicona  
Moules silicone



MEDIA BOLA

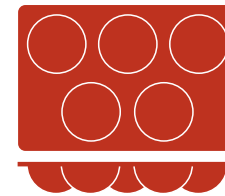

REF	Fig	Ø cm	H cm	Fig
P850001	5	8	4	1

MEDIA BOLA

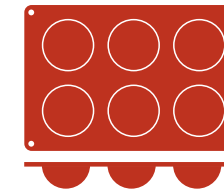

REF	Fig	Ø cm	H cm	Fig
P850002	6	7	3,5	1

MEDIA BOLA

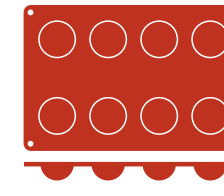

REF	Fig	Ø cm	H cm	Fig
P850003	8	6	3	1

MEDIA BOLA

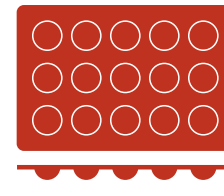

REF	Fig	Ø cm	H cm	Fig
P850004	15	5	2,5	12

MEDIA BOLA

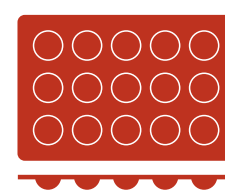

REF	Fig	Ø cm	H cm	Fig
P850005	15	4	2	1

MEDIA BOLA

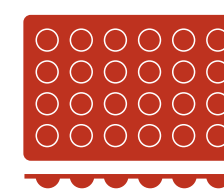

REF	Fig	Ø cm	H cm	Fig
P850006	24	3	1,5	12

PIRAMIDE



REF	Fig	cm	H cm	Fig
P850007	6	7,1 x 7,1	4	1

SAVARIN

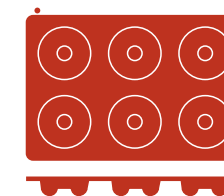

REF	Fig	Ø cm	H cm	Fig
P850012	6	7,2	2,3	1

OVAL

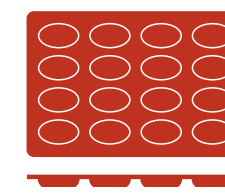

REF	Fig	cm	H cm	Fig
P850017	24	3	1,5	1

OVAL

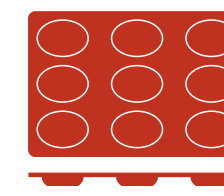

REF	Fig	cm	H cm	Fig
P850018	9	7x5	2	1

MUFFIN

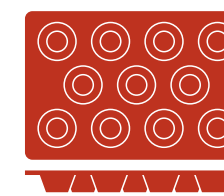

REF	Fig	Ø cm	H cm	Fig
P850022	11	5	2,8	1

MUFFIN

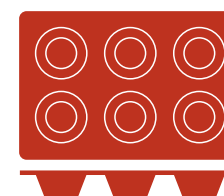

REF	Fig	Ø cm	H cm	Fig
P850023	6	7	3,7	12

MUFFIN

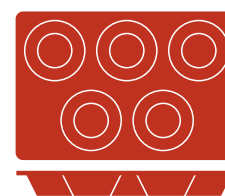

REF	Fig	Ø cm	H cm	Fig
P850024	5	8	3,5	1

CAKE

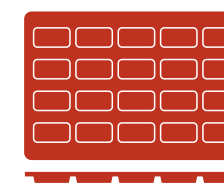

REF	Fig	cm	H cm	Fig
P850025	20	4,9 x 2,6	11	1

CAKE

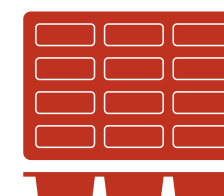

REF	Fig	cm	H cm	Fig
P850026	12	8 x 3	3	1

PETIT FOUR

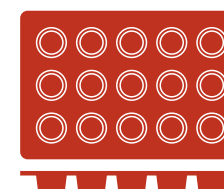

REF	Fig	Ø cm	H cm	Fig
P850027	15	4	2	1

CILINDRO

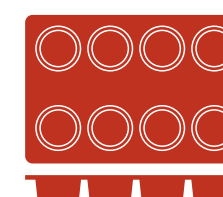

REF	Fig	Ø cm	H cm	Fig
P850028	8	6	3,5	1

MADALENA

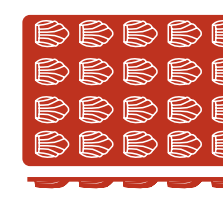

REF	Fig	cm	H cm	Fig
P850031	20	3,8 x 3	1	1

BORDELAIS

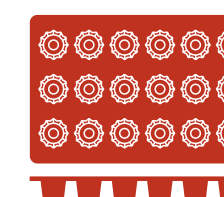

REF	Fig	Ø cm	H cm	Fig
P850033	18	3,5	3,5	1

## 6.8 Silicone moulds

Moldes silicona  
Moules silicone



Silicone moulds 600 x 400 mm. Possible to divide in two of 300 x 200 mm thanks to its symmetrical design  
Moldes de silicona 600 x 400 mm Ofrecen la posibilidad de dividirlos en 2 moldes de 300 x 200 mm gracias a su diseño simétrico  
Moules en silicone 600 x 400 mm avec possibilité de diviser en deux moules de 300 x 200 mm grâce à sa symétrie

### P859900 Mini-cakes



600 x 400 mm

Ref	Fig	cm1	cm2	H cm	
P859900	20	10 x 5	8 x 3	30	1

### P859901 Briochette



600 x 400 mm

Ref	Fig	Ø cm	H cm	
P859901	24	7,9	3,7	1

### P859902 Half-spheres Semi-esferas Demi-sphères



600 x 400 mm

Ref	Fig	Ø cm	H cm	
P859902	24	7	3,5	1

### P859903 Muffin



600 x 400 mm

Ref	Fig	Ø cm	H cm	
P859903	24	7	4,2	1

### P859904 Mini muffin



600 x 400 mm

Ref	Fig	Ø cm	H cm	
P859904	20	5	2,8	1

### P859905 Gugelhopf



600 x 400 mm

Ref	Fig	Ø cm	H cm	
P859905	24	7	3,6	1

## Silicone moulds 6.8

Moldes silicona  
Moules silicone



### P859907 Mini madeleines Mini madalenas Mini madeleines



600 x 400 mm

REF	Fig	Ø cm	H cm	
P859907	84	4,2 x 3	1,1	1

### P859908 Tartalets Tartaletas Tartalettes



600 x 400 mm

REF	Fig	Ø cm	H cm	
P859908	60	5	1,5	1

### P859909 Cannelés Canalados



600 x 400 mm

REF	Fig	Ø cm	H cm	
P859909	60	8,5	5	1

### P859910 Pyramids Piramides Pyramides



600 x 400 mm

REF	Fig	cm	H cm	
P859910	30	7,1 x 7,1	4	1

### P859911 Florentiners Florentinas Florentins



600 x 400 mm

REF	Fig	Ø cm	H cm	
P859911	40	5,5	1,2	1

# 7 Gastronorm containers

Cubetas gastronorm  
Bacs gastronorme

GN CONTAINERS  
CUBETAS GN  
BACS GN



**7.1**  **18/10 ST/STEEL** 194  
*INOX 18/10*

**7.2**  **GASTRONORM ACCESSORIES** 198  
*COMPLEMENTOS GASTRONORM  
ACCESSOIRES GASTRONORME*

**7.3**  **WITH SANDWICH BOTTOM** 199  
*CON FONDO DIFUSOR  
AVEC FOND THERMO-DIFFUSEUR*

**7.4**  **SUPER PAN 3** 200

**7.5**  **POLYCARBONATE** 202  
*POLICARBONATO  
POLYCARBONATE*

**7.6**  **BISPHENOL-A FREE** 204  
*SIN BISFENOL-A  
SANS BISPHÉNOL-A*

**7.7**  **POLYPROPYLENE** 206  
*POLIPROPILENO  
POLYPROPYLÈNE*

**7.8**  **VIOLET COLLECTION** 208

GN CONTAINERS  
CUBETAS GN  
BACS GN

# Gastronorm containers

Cubetas gastronorm  
Bacs gastronorme

According to en-631.2 Pujadas offers one of the most specialized ranges, in-house manufacturing, of gastronorm containers in the market.

Conforme a la norma en-631.2 Pujadas ofrece una de las gamas de cubetas gastronorm de fabricación propia más amplia del mercado.

Suivant la norme en-631.2 Pujadas propose une des gammes de bacs gastronorm de propre fabrication des plus spécialisés du marché.

## Stainless Steel Acero Inoxidable Acier Inox

18/10



**Reinforced edges**  
Bordes reforzados  
Bords renforcés

**Radius specially designed for: + capacity + cleaning**  
Geometría adaptada: + limpieza + capacidad  
Géométrie adaptée: + propreté + capacité

## Polycarbonate Policarbonato Polycarbonate

- 40 °C  
+ 130 °C

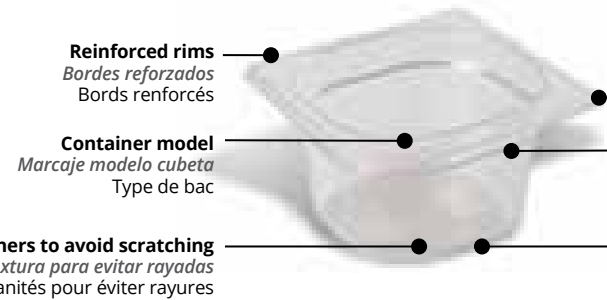

**Reinforced rims**  
Bordes reforzados  
Bords renforcés

**Container model**  
Marcaje modelo cubeta  
Type de bac

**Texturing corners to avoid scratching**  
Textura para evitar rayadas  
Côtés granités pour éviter rayures

**Thicker**  
Mayor grosor  
Plus épais

**Graduations marked externally**  
Graduación externa de capacidad  
Échelle de graduations à l'extérieur

**Main features marked on the base**  
Características marcadas en el fondo  
Caractéristiques marqués au fond

## Bisphenol-A free Sin bisfenol-A Sans bisphénol-A

- 40 °C  
+ 90 °C



Containers made of copolyester without Bisphenol-A (100% BPA FREE).  
Cubetas en copoliéster sin Bisfenol-A (100% BPA FREE)  
Bacs en copolyester sans Bisphénol-A (100% BPA FREE)

## Polypropylene Polipropileno Polypropylène

- 40 °C  
+ 110 °C

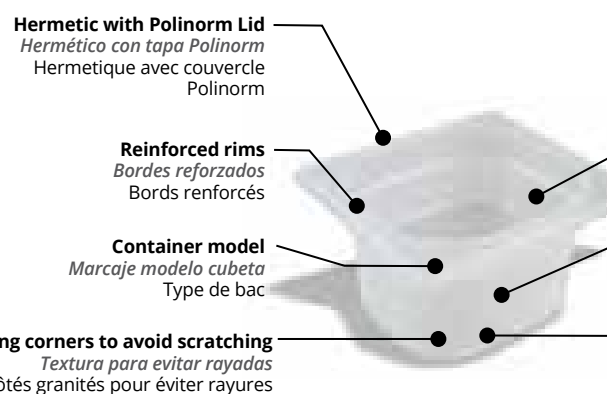

**Hermetic with Polinorm Lid**  
Hermético con tapa Polinorm  
Hermetique avec couvercle Polinorm

**Reinforced rims**  
Bordes reforzados  
Bords renforcés

**Container model**  
Marcaje modelo cubeta  
Type de bac

**Texturing corners to avoid scratching**  
Textura para evitar rayadas  
Côtés granités pour éviter rayures

**Thicker**  
Mayor grosor  
Plus épais

**Graduations marked externally**  
Graduación externa de capacidad  
Échelle de graduations à l'extérieur

**Main features marked on the base**  
Características marcadas en el fondo  
Caractéristiques marqués au fond

# Gastronorm containers

Cubetas gastronorm  
Bacs gastronorme

## Cooking Cocción Cuisson

PATENTED EXCLUSIVE



**GN Pan with sandwich base**  
GN con fondo difusor  
Bac GN avec fond thermo-diffuseur



**Non-stick aluminium GN pan**  
GN aluminio antiadherente  
Bac GN anti-adhésif en aluminium

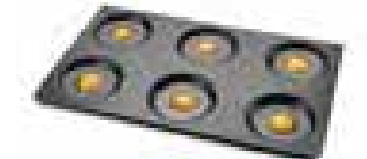

**Special Oven GN pans**  
Bandejas GN especial horno  
PLAQUES spéciales GN pour four

## Transport Transporte Transport



**St/Steel GN + St/Steel hermetic lid**  
GN Inox + Tapa inox hermética  
Bac GN Inox + Couvercle étanche inox

TEMP. 120°C  
HERMÉTICO / HERMETIC / ÉTANCHE



**Polycarbonate or BPA free + Polinorm lid**  
Policarbonato o cubeta sin Bisfenol-A + tapa polinorm  
Polycarbonate ou sans BPA + couvercle Polinorm

TEMP. 100°C



**Polypropylene + Polinorm lid**  
GN Polipropileno + Tapa Polinorm®  
GN Polypropylène + Couvercle Polinorm®

TEMP. 90°C

## Storage Almacenamiento Stockage

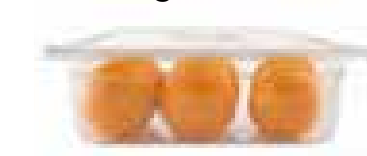

**Polycarbonate GN + Polycarbonate Lid**  
GN Polycarbonato + Tapa polycarbonato  
GN Polycarbonate + Couvercle Polycarbonate



**Polycarbonate GN + Polinorm lid**  
GN Polycarbonato + Tapa Polinorm®  
Polycarbonate + Couvercle Polinorm®



**Polypropylene + Polinorm lid**  
GN Polipropileno + Tapa Polinorm®  
GN Polypropylène + Couvercle Polinorm®



**Allergen-Free**  
Antialérgico  
Anti allergique

## Display Presentación Présentation



**Polycarbonate GN + Polycarbonate Lid**  
GN Polycarbonato + Tapa polycarbonato  
GN Polycarbonate + Couvercle Polycarbonate



**St/Steel GN with sandwich base + Polycarbonate Lid**  
GN Inox con fondo Difusor + Tapa polycarbonato  
GN Inox avec fond thermo-diffuseur + Polycarbonate

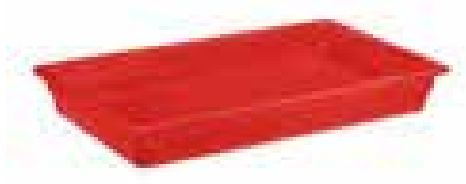

**Melamine GN**  
GN Melamina  
GN mélamine

See products on  
Ver productos en  
Voir produits en page

P. 380



# GN containers selection

Selección cubetas gastronorm  
Selection bacs gastronorme

**18/10 St/steel**  
Inox 18/10  
Inox 18/10

**18/10 St/steel sandwich bottom**  
Inox 18/10 fondo difusor  
Inox 18/10 fond thermo-diffuseur

**Non-stick aluminium**  
Aluminio antiadherente  
Aluminium anti-adhésif

**Polycarbonate**  
Policarbonato  
Polycarbonate

**Bisphenol-A free**  
Sin bisfenol-A  
Sans bisphénol-A

**Polypropylene**  
Polipropileno  
Polypropylène

**Melamine\***  
Melamine\*  
Mélamine\*



P. 194



P. 199



P. 401



P. 89



P. 202



P. 204



P. 206

VIOLET  
COLLECTION



P. 374

**APPEARANCE**  
PRESENTACIÓN  
PRÉSENTATION



**ROBUSNESS**  
RESISTENCIA  
ROBUSTESSE



**STORAGE**  
ALMACENAMIENTO  
STOCKAGE



**BAIN MARIE**  
BAÑO-MARIA  
BAIN-MARIE



**TEMPERATURE MAX**  
TEMPERATURA MAX  
TEMPÉRATURE MAX.



130 °C

90 °C

110 °C

70 °C

**OVEN**  
HORNO  
FOUR



130 °C

**MICRO-WAVE**  
MICROONDAS  
MICRO-ONDES



**COOKING**  
COCCIÓN  
CUISSON



**INDUCTION**  
INDUCCIÓN  
INDUCTION



INDUCTION



INDUCTION

**WARM TRANSPORTATION**  
TRANSPORTE EN CALIENTE  
TRANSPORT CHAUD



130 °C

80 °C

70 °C

**POLINORM LID**  
TAPA POLINORM  
COUVERCLE POLINORM



✓ RECOMMENDED / RECOMENDADO / RECOMMANDÉ

● SUITABLE / ACEPTABLE / ACCEPTABLE

\* HUMID ENVIRONMENT / AMBIENTE HÚMEDO / ENVIRONNEMENT HUMIDE

GN CONTAINERS  
CUBETAS GN  
BACS GN

GN CONTAINERS  
CUBETAS GN  
BACS GN

# Sizes and combinations

Medidas y combinaciones  
Mesures et combinaisons



## Fitting measures / Medidas de encaste / Mesures d'emboîtement

Modelo	"A"	"B"
2/1	630	510
1/1	510	305
2/3	333	305
1/2	305	245
1/3	305	155
1/4	245	142
1/6	156	142
1/9	156	88

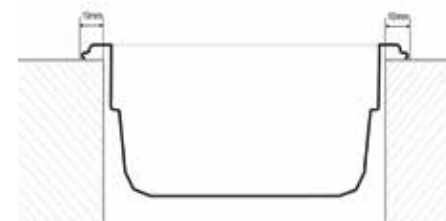
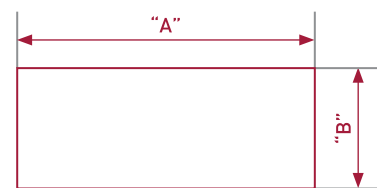

## GN polynorm® lid

Tapa GN polinorm®  
GN couvercle polynorm®

AVAILABLE IN FOUR COLOURS  
DISPONIBLE EN CUATRO COLORES  
DISPONIBLE EN QUATRE COULEURS



PATENTED EXCLUSIVE



ADJUSTABLES TO / ADAPTABLES A / ADAPTABLE À

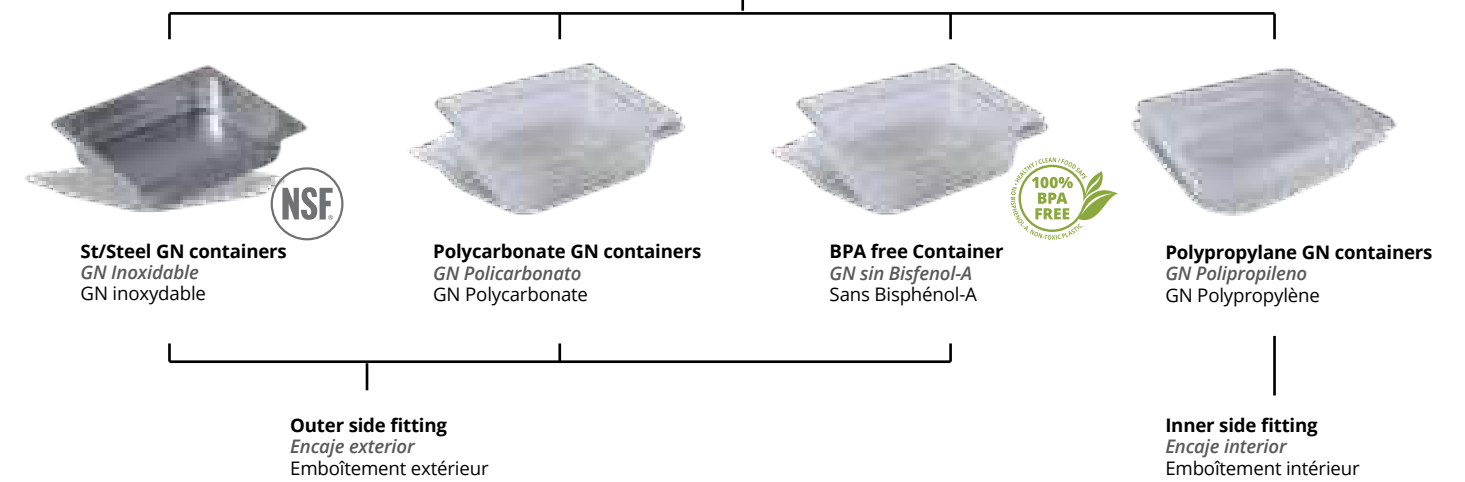

### Flaps to fit with GN inox and PC

Clips para cierre cubeta inox y PC  
Rainures pour clipser bacs GN inox et PC

Polinorm Lid  
Tapa Polinorm  
Couvercle Polinorm

Steel container / Polycarbonate  
Cubeta inox / Policarbonato  
Bac inox / Polycarbonate

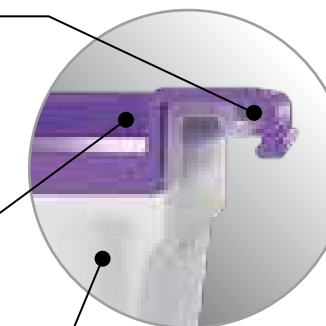

Polinorm Lid  
Tapa Polinorm  
Couvercle Polinorm

Hermetical for PP containers  
Cierre hermético para cubetas de PP  
Hermetique sur bacs PP

Container polypropylene  
Cubeta polipropileno  
Bac polypropylène

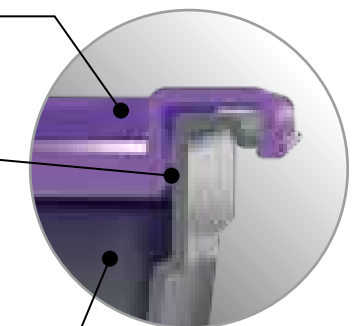

# 7.1 18/10 St/steel gastronorm

Gastronorm inox 18/10  
Gastronorme inox 18/10



18/10  
Stainless  
steel

## 2/1 650 x 530 mm



REF	H mm	Lts	
P210201	20	6,2	1
P210401	40	11,5	1
P210651	65	18,8	1
P211001	100	28,9	1
P211501	150	43,1	1
P212001	200	52,0	1

## 1/1 530 x 325 mm



REF	H mm	Lts	
P110101	10	1,25	6 <b>NEW</b>
P110201	20	2,80	6
P110401	40	5,10	6
P110551	55	7,00	6
P110651	65	8,30	6
P111001	100	14,20	6
P111501	150	20,20	6
P112001	200	26,00	6

## 2/3 353 x 325 mm



REF	H mm	Lts	
P230101	10	1,5	6 <b>NEW</b>
P230201	20	1,7	6
P230401	40	3,1	6
P230651	65	5,6	6
P231001	100	8,8	6
P231501	150	13,2	10
P232001	200	18,3	10

## 1/2 325 x 265 mm



REF	H mm	Lts	
P120101	10	1,0	6 <b>NEW</b>
P120201	20	1,2	6
P120401	40	2,2	6
P120651	65	4,1	6
P121001	100	6,1	6
P121501	150	9,1	6
P122001	200	12,0	6

## 2/4 530 x 162 mm



REF	H mm	Lts	
P240401	40	1,80	1
P240651	65	4,00	1
P241001	100	6,00	1
P241501	150	10,00	1

## 1/3 325 x 176 mm



REF	H mm	Lts	
P130201	20	0,8	6
P130401*	40	1,5	6
P130651	65	2,5	6
P131001	100	3,8	6
P131501	150	5,6	12
P132001	200	7,3	12

**IDEA!** \* Special GN container for snack showcases.  
\* Cubeta GN especial para vitrinas mostrador snack.  
\* Bac GN spécial pour vitrines snack.

# 18/10 St/steel gastronorm 7.1

Gastronorm inox 18/10  
Gastronorme inox 18/10

18/10  
Stainless  
steel



## 1/4 265 x 162 mm



REF	H mm	Lts	
P140201	20	0,5	6
P140651	65	1,7	6
P141001	100	2,8	6
P141501	150	4,1	6
P142001	200	5,0	6

## 1/6 176 x 162 mm



REF	H mm	Lts	
P160651	65	1,0	6
P161001	100	1,6	6
P161501	150	2,2	6
P162001	200	2,9	6

## 1/9 176 x 108 mm



REF	H mm	Lts	
P190651	65	0,6	6
P191001	100	0,8	6

### Falling handles

Asas móviles  
Anses tombantes



Suitable for all GN sizes  
Apta para todas las medidas de cubetas  
Apte sur toutes les dimensions GN

1

### Fixed handles

Asas fijas  
Anses fixes



Only for containers 1/2, 1/3, 1/4 and 1/6  
Sólo para cubetas 1/2, 1/3, 1/4 y 1/6  
Seulement pour bacs 1/2, 1/3, 1/4 et 1/6

1

### Perforated bottoms for containers

Fondos perforados para cubetas  
Egouttoirs pour bacs

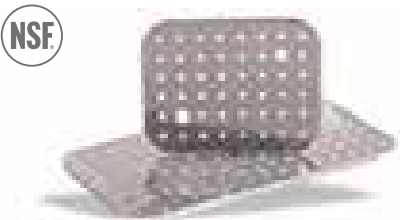

Adjustable to SP3 upto 100 mm depth  
Aptos para cubetas SP3 hasta 100 mm de profundidad  
Adaptables à bacs SP3 jusqu'à 100 mm profondeur

REF	Mod	
P215000	2/1	1
P115000	1/1	1
P235000	2/3	1
P125000	1/2	1
P135000	1/3	1
P145000	1/4	1

### Adaptable bars

Perfiles divisorios  
Barrettes de composition



To arrange any composition with gastronorm containers.  
Para realizar cualquier composición con las cubetas gastronorm.  
Pour réaliser toute composition avec les bacs gastronorme.

REF	H mm	L cm	
P111111	1/1	53,0	1
P122222	1/2	32,5	1

# 7.1 18/10 St/steel gastronorm

Gastronorm inox 18/10  
Gastronorme inox 18/10



18/10  
Stainless steel

## 2/1 650 x 530 mm



REF	H mm	
P210202	20*	6
P210402	40*	6
P210652	65*	6
P211002	100**	6
P211502	150**	3
P212002	200**	3

## 1/1 530 x 325 mm



REF	H mm	
P110202	20*	6
P110402	40*	6
P110552	55*	6
P110652	65*	6
P111002	100**	6
P111502	150**	6
P112002	200**	6

## 2/3 353 x 325 mm

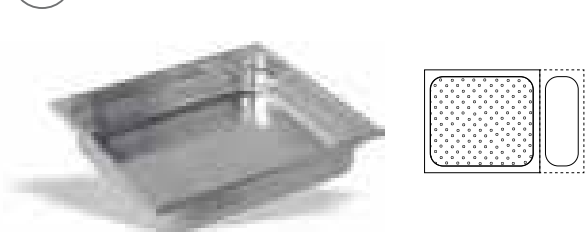

REF	H mm	
P230202	20*	6
P230402	40*	6
P230652	65*	6
P231002	100**	6
P231502	150**	6
P232002	200**	6

## 1/2 325 x 265 mm



REF	H mm	
P120652	65*	6
P121002	100**	6
P121502	150**	6
P122002	200**	6

## 1/3 325 x 176 mm



REF	H mm	
P130202	20*	6
P130402	40*	6
P130652	65*	6
P131002	100**	6
P131502	150**	6
P132002	200**	6

\*Perforated bottom.  
\*Fondo perforado.  
\*Fond perforé.

\*\*Perforated bottom and sides.  
\*\*Fondo y laterales perforados.  
\*\*Fonds et latéraux perforés.

# 18/10 St/steel gastronorm 7.1

Gastronorm inox 18/10  
Gastronorme inox 18/10

18/10  
Stainless steel



Easy Open hermetic lid  
Tapa hermética Easy Open  
Couvercle hermétique Easy Open

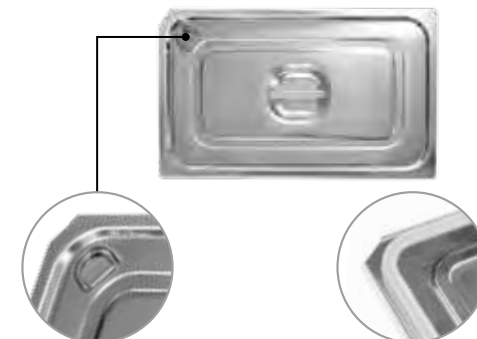

\* Lug for easy opening  
Tirador para fácil apertura  
Poignée pour une ouverture facile

Silicone gasket for hermetic closure  
Junta de silicona para cierre hermético  
Joint en silicone pour fermeture hermétique

REF	Mod	
P110004EO*	1/1	1
P120004EO	1/2	1

Hermetic lid  
Tapa hermética  
Couvercle étanche



Silicone joint  
Detalle silicona  
Joint silicone

REF	Mod	
P110004	1/1	1
P120004	1/2	1
P130004	1/3	1
P140004	1/4	1
P160004	1/6	1

Polinorm® Lid  
Tapa Polinorm®  
Couvercle Polinorm®

**PATENTED EXCLUSIVE**



REF	Mod	
P1100 + COLOR	1/1	30
P1200 + COLOR	1/2	60
P1300 + COLOR	1/3	30
P1400 + COLOR	1/4	30
P1600 + COLOR	1/6	60
P1900 + COLOR	1/9	30

Lid  
Tapa  
Couvercle

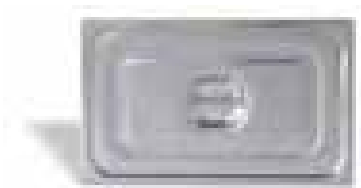

REF	Mod	
P110000	1/1	1
P230000	2/3	1
P120000	1/2	1
P130000	1/3	1
P140000	1/4	1
P160000	1/6	1
P190000	1/9	1

Flat lid without handle  
Tapa plana sin asa  
Couvercle plat sans anse



REF	Mod	
P110005	1/1	1
P120005	1/2	1

Ref. colour lid  
Ref. color tapa  
Ref. couleur couvercle



Available for 1/1, 1/2, 1/3 and 1/6  
Disponibile para 1/1, 1/2, 1/3 y 1/6  
Disponible pour 1/1, 1/2, 1/3 et 1/6

St/Steel, PC, Bisphenol-A FREE and PP GN containers.  
Not for SP3 range.

Cubetas GN inox, PC, sin Bisfenol-A y PP.  
No aptas para la gama SP3.

Bacs GN inox, PC, sans Bisphénol-A et PP.  
Pas pour la gamme SP3.

## 7.2 Gastronorm accessories

Complementos gastronorm  
Accessoires gastronorme



Attach the lid, aluminium foil or cling film to the tray for secure transport or storage. Dishwasher safe. Easy to use.

Fija la tapa, el papel de aluminio o el papel film, a la cubeta, para un transporte y almacenamiento seguro. Apta para lavavajillas. Fácil de usar.

Fixe le couvercle, le papier d'aluminium ou le film alimentaire au bac pour transport et stockage de façon sûre. Va au lave-vaisselle. Facile à utiliser.

**N-0001B GN Pan Band. Black**  
Banda selladora silicona GN. Negra  
Bande à silicone GN. Noir



**PATENTED EXCLUSIVE**

+232,2°C



REF	type / tipo	
N-0001B	1/1	24
N-0002B	1/2	24
N-0003B	1/3	24
N-0006B	1/6	24

**P100004P Stand for GN containers**

Presentador cubetas GN  
Support pour bacs GN



REF		
P100004P	Only stand / Soporte solo / Support seul	1

REF	Set / Conjunto / Lot	
P100005P	6 - GN 1/9 65 mm	1
P100006P	6 - GN 1/9 100 mm	1
P100008P	4 - GN 1/6 100 mm	1

It can contain / Permiten sostener / Il peut contenir

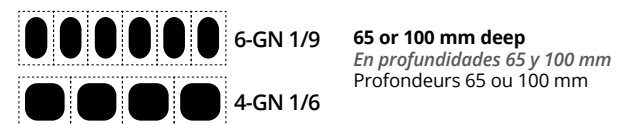

Adjustable to GN container in polycarbonate and polypropylene  
Adaptable a cubetas GN policarbonato y polipropileno  
Adapté à bacs GN en polycarbonate et polypropylène

**P100003P Stand for GN lids**

Soporte para tapas GN  
Support pour couvercles GN

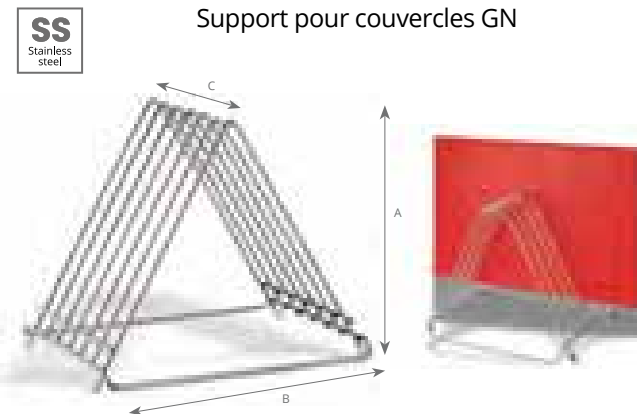

For 6 lids  
Para 6 tapas  
Pour 6 couvercles

Distance between wires 2,5 cm  
Distancia entre varillas 2,5 cm  
Distance entre fils 2,5 cm

**IDEA!** Perfect for cutting boards. Refer to page 138-140  
Ideal para tablas de corte. Ver página 138-140  
Ideal pour planches à découper. Voir page 138-140

REF	A cm	B cm	C cm	
P100003P	27	31	27	1

## With sandwich bottom 7.3

Con fondo difusor  
Avec fond thermo-diffuseur

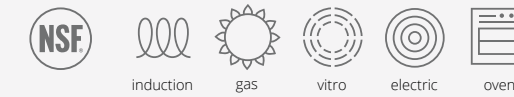

**Sandwich bottom GN container**  
Cubeta GN con fondo difusor  
Bac GN avec fond thermo-diffuseur

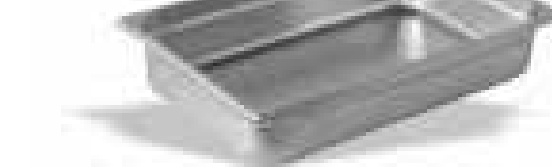

REF	Tipo / Type	H mm	Lts	
P1106F1	1/1	65	8,3	1
P1110F1	1/1	100	14,2	1
P1115F1	1/1	150	20,2	1
P1206F1	1/2	65	4,1	1

See products on  
Ver productos en / Voir produits en page

**Non-stick GN container**  
Cubeta GN antiadherente  
Bac GN anti-adhésive



**PATENTED EXCLUSIVE**

GN containers with sandwich base, suitable for cooking directly on any kind of stoves including induction.

Cubetas GN con fondo difusor: únicas, adaptadas a la cocción en placas de inducción mediante fondo sandwich (inox-alu-inox).

Bacs GN avec fond thermo-diffuseur apte sur tout type de cuisinières, surtout en induction.



**Sandwich bottom GN container with handles**  
Cubeta GN con fondo difusor y asas  
Bac GN avec fond thermo-diffuseur et anses



REF	Tipo / Type	H mm	Lts	
P1110F2	1/1	100	14,2	1
P1115F2	1/1	150	20,2	1

**P. 401**

# 7.4 Super Pan 3

**NEW!**

SS  
Stainless  
steel

FCA

FOOD CONTACT  
APPROVED

**Reinforced spouted-shape corners**  
Esquinas reforzadas con forma de pico  
Coins reforçés en forme de bec

**Anti-jam stacking lugs**  
Apilado antiatascos  
Pointes d'empilage anti-coincement

**Narrow radius**  
Radio estrecho  
Rayon étroit

**Bordes aplanados**  
Flattened pan edges  
Bords de bacs gn aplatis



**1/1 530 x 325 mm**

NSF



REF	H mm	Lts	
90002	20	-	6
90012	40	5,4	6
90052	55	7,3	6
90022	65	8,5	6
90042	100	13,4	6
90062	150	19,9	6
90082	200	26,1	3

**2/3 353 x 325 mm**

NSF



REF	H mm	Lts	
90102	20	-	6
90112	40	3,4	6
90122	65	5,4	6
90142	100	8,0	6
90162	150	11,9	3
90182	200	15,5	3

**1/2 325 x 265 mm**

NSF



REF	H mm	Lts	
90202	20	-	6
90212	40	2,4	6
90252	55	3,3	6
90222	65	3,8	6
90242	100	6,0	6
90262	150	8,9	6
90282	200	11,6	3

**2/4 530 x 162 mm**

NSF



REF	H mm	Lts	
90502	20	-	6
90512	30	2,4	6
90552	55	3,1	6
90522	65	3,7	6
90542	100	5,7	3
90562	150	8,2	3

# Super Pan 3 7.4

**NEW!**

SS  
Stainless  
steel

**1/3 325 x 176 mm**

NSF



REF	H mm	Lts	
90302	20	-	6
90312	40	1,6	6
90352	55	2,0	6
90322	65	2,4	6
90342	100	3,7	6
90362	150	5,5	6
90382	200	7,1	3

**1/6 176 x 162 mm**

NSF



REF	H mm	Lts	
90622	65	1,1	6
90642	100	1,6	6
90662	150	2,3	6
90682	200	3,0	3

**1/1 530 x 325 mm**

NSF



REF	H mm	
90013	40*	6
90053	55*	6
90023	65*	6
90043	100**	6
90063	150**	6

**93100 Lid**  
Tapa  
Couvercle

NSF



Lids and false bottoms, use the same as our standard range.  
False bottoms just to 100 mm depth.

Tapas y fondos perforados, se pueden utilizar los de la gama de cubetas inox.  
Fondos hasta 100 mm de profundidad.

Couvercles and egouttoirs, utiliser les memes que la gamme standard.  
Egouttoirs jusqu'à 100 mm profondeur.

**1/4 265 x 162 mm**

NSF



REF	H mm	Lts	
90402	20	-	6
90412	40	1,1	6
90452	55	1,5	6
90422	65	1,7	6
90442	100	2,6	6
90462	150	3,8	6
90482	200	4,8	3

**1/9 176 x 108 mm**

NSF



REF	H mm	Lts	
90922	65	0,60	6
90942	100	0,80	6

**1/2 325 x 265 mm**

NSF



REF	H mm	
90213	40*	6
90223	65*	6
90243	100**	6
90263	150**	6

REF	Mod	
93100	1/1	6
93110	2/3	6
93200	1/2	6
93500	2/4	6
93300	1/3	6
93400	1/4	6
93600	1/6	6
93900	1/9	6

\*Perforated bottom.  
\*Fondo perforado.  
\*Fond perforé.

\*\*Perforated bottom and sides.  
\*\*Fondo y laterales perforados.  
\*\*Fonds et latéraux perforés.

GN CONTAINERS  
CUBETAS GN  
BACS GN

GN CONTAINERS  
CUBETAS GN  
BACS GN

# 7.5 Polycarbonate gastronorm

Gastronorm policarbonato  
Gastronorme polycarbonate



● - 40 °C  
● + 130 °C

**Use: storage of bulk products, various ingredients in refrigerators or cold rooms. For cold buffet presentation.**

*Utilización: almacenamiento de productos a granel, ingredientes varios en neveras o cámaras frigoríficas. Ideales para presentación en buffets fríos.*

Utilisation : stockage de produits en vrac, divers ingrédients dans des réfrigérateurs ou des chambres froides. Pour présentation de buffets froids.



## 1/1 530 x 325 mm



REF	H mm	Lts	
P1106C1	65	8,70	12
P1110C1	100	13,30	12
P1115C1	150	19,60	12
P1120C1	200	25,50	6

## 1/2 325 x 265 mm



REF	H mm	Lts	
P1206C1	65	4,00	30
P1210C1	100	6,00	24
P1215C1	150	8,70	24
P1220C1	200	11,20	18

## 1/3 325 x 175 mm



REF	H mm	Lts	
P1306C1	65	2,35	30
P1310C1	100	3,50	24
P1315C1	150	5,00	24
P1320C1	200	6,35	18

## 1/4 265 x 162 mm



REF	H mm	Lts	
P1406C1	65	1,65	18
P1410C1	100	2,46	18
P1415C1	150	3,47	12

# Polycarbonate gastronorm 7.5

Gastronorm policarbonato  
Gastronorme polycarbonate



## 1/6 176 x 162 mm



REF	H mm	Lts	
P1606C1	65	0,95	30
P1610C1	100	1,40	24
P1615C1	150	1,95	24

### Polycarbonate lid

Tapa policarbonato  
Couvercle Polycarbonate



REF	Mod	
P1100C1	1/1	30
P1200C1	1/2	60
P1300C1	1/3	30
P1400C1	1/4	30
P1600C1	1/6	60
P1900C1	1/9	30

### Polinorm® Lid

Tapa Polinorm®  
Couvercle Polinorm®



REF	Mod	
P1100 + COLOR	1/1	30
P1200 + COLOR	1/2	60
P1300 + COLOR	1/3	30
P1400 + COLOR	1/4	30
P1600 + COLOR	1/6	60
P1900 + COLOR	1/9	30

## 1/9 176 x 108 mm



REF	H mm	Lts	
P1906C1	65	0,54	30
P1910C1	100	0,77	30

### Perforated bottom

Fondo perforado  
Fond perforé



REF	Mod	
P1150C1	1/1	36
P1250C1	1/2	24
P1350C1	1/3	24
P1450C1	1/4	30

Ref. colour lid  
Ref. color tapa  
Ref. couleur couvercle

- P1 P2 P3 P4 P5
- P6 Available for 1/1, 1/2, 1/3 and 1/6  
Disponible para 1/1, 1/2, 1/3 y 1/6  
Disponible pour 1/1, 1/2, 1/3 et 1/6

St/Steel, PC, Bisphenol-A FREE and PP GN containers.  
Not for SP3 range.

Cubetas GN inox, PC, sin Bisfenol-A y PP.  
No aptas para la gama SP3.

Bacs GN inox, PC, sans Bisphénol-A et PP.  
Pas pour la gamme SP3.

## 7.6 Gastronorm containers, Bisphenol-A free

Cubetas gastronorm sin Bisfenol-A  
Bacs gastronorme sans Bisphénol-A



- 40 °C  
+ 90 °C



Containers made of copolyester without Bisphenol-a (100% BPA FREE). An alternative material to polycarbonate. Complies with european standard en 631.1 (compatible with gastronorm systems and appliances) excellent transparency and impact resistance. Ideal for storing products in cold rooms, for preparation. Stackable containers.

Cubetas en copoliester sin Bisfenol-a (100% BPA FREE). Es un material alternativo al policarbonato. Conformes con la norma europea en 631.1 (compatible con los equipos y aparatos gastronorm). Excelente transparencia y resistencia a los impactos. Ideales para almacenar productos en cámaras frigoríficas, de preparación. Cubetas apilables.

Bacs en copolyester sans Bisphénol-a (100% BPA FREE). Il s'agit d'un matériau alternatif au polycarbonate. Conformes à la norme européenne en 631.1 (compatible avec les machines et appareils gastronorm). Excellentes transparence et résistance aux chocs. Idéales pour emmagasiner des produits dans des chambres froides, de préparation. Cuvettes empilables.

1/1 530 x 325 mm



REF	H mm	Lts	
P1106BF	65	8,70	12
P1110BF	100	13,30	12
P1115BF	150	19,60	12
P1120BF	200	25,50	6

1/2 325 x 265 mm



REF	H mm	Lts	
P1206BF	65	4,00	30
P1210BF	100	6,00	24
P1215BF	150	8,70	24
P1220BF	200	11,20	18

1/3 325 x 175 mm



REF	H mm	Lts	
P1306BF	65	2,35	18
P1310BF	100	3,50	12
P1315BF	150	5,00	12

1/4 265 x 162 mm



REF	H mm	Lts	
P1406BF	65	1,65	18
P1410BF	100	2,46	18
P1415BF	150	3,47	12

## Gastronorm containers, Bisphenol-A free 7.6

Cubetas gastronorm sin Bisfenol-A  
Bacs gastronorme sans Bisphénol-A



1/6 176 x 162 mm



REF	H mm	Lts	
P1606BF	65	0,95	30
P1610BF	100	1,40	24
P1615BF	150	1,95	24

1/9 176 x 108 mm



REF	H mm	Lts	
P1906BF	65	0,54	30
P1910BF	100	0,77	30

Gastronorm lid  
Tapa gastronorm  
Couvercle gastronorme



REF	Mod	
P1100BF	1/1	30
P1200BF	1/2	60
P1300BF	1/3	30
P1400BF	1/4	30
P1600BF	1/6	60
P1900BF	1/9	30

Perforated bottom  
Fondo perforado  
Fond perforé



REF	Mod	
P1150BF	1/1	36
P1250BF	1/2	24
P1350BF	1/3	24
P1450BF	1/4	30
P1650BF	1/6	30

Polinorm® Lid  
Tapa Polinorm®  
Couvercle Polinorm®

PATENTED EXCLUSIVE



REF	Mod	
P1100 + COLOR	1/1	30
P1200 + COLOR	1/2	60
P1300 + COLOR	1/3	30
P1400 + COLOR	1/4	30
P1600 + COLOR	1/6	60
P1900 + COLOR	1/9	30

Ref. colour lid  
Ref. color tapa  
Ref. couleur couvercle



St/Steel, PC, Bisphenol-A FREE and PP GN containers.  
Not for SP3 range.

Cubetas GN inox, PC, sin Bisfenol-A y PP.  
No aptas para la gama SP3.

Bacs GN inox, PC, sans Bisphénol-A et PP.  
Pas pour la gamme SP3.



# 7.7 Polypropylene gastronorm

Gastronorm polipropileno  
Gastronorme polypropylène



**PATENTED EXCLUSIVE**



- 40 °C  
+ 110 °C

Use to store bulk products and ingredients in coolers, freezers or pantry. Highly recommended for transportation and micro-waves cooking. Translucent plastic makes inventory easy. High resistance to chemicals.

Utilización: almacenamiento de productos a granel, ingredientes varios en neveras o cámaras frigoríficas. Ideal para transporte y cocción en microondas. El plástico translúcido facilita el inventario. Alta resistencia a productos químicos.

Utilisation: stockage de produits et ingrédients en vrac dans des unités réfrigérées ou placards. Idéal pour le transport et la cuisson en FOUR micro-ondes. Le plastique translucide facilite l'inventaire. Haute résistance aux produits chimiques.

**1/1 530 x 325 mm**



REF	H mm	Lts	
P1106P1	65	8,70	12
P1110P1	100	13,30	12
P1115P1	150	19,60	12
P1120P1	200	25,50	6

**1/2 325 x 265 mm**



REF	H mm	Lts	
P1206P1	65	4,00	30
P1210P1	100	6,00	24
P1215P1	150	8,70	24
P1220P1	200	11,20	18

# Polypropylene gastronorm 7.7

Gastronorm polipropileno  
Gastronorme polypropylène



**1/3 325 x 175 mm**



REF	H mm	Lts	
P1306P1	65	2,35	18
P1310P1	100	3,50	12
P1315P1	150	5,00	12
P1320P1	200	6,35	6

**1/4 265 x 162 mm**



REF	H mm	Lts	
P1406P1	65	1,65	18
P1410P1	100	2,46	18
P1415P1	150	3,47	12

**1/6 176 x 162 mm**



REF	H mm	Lts	
P1606P1	65	0,95	30
P1610P1	100	1,40	24
P1615P1	150	1,95	24

**1/9 176 x 108 mm**



REF	H mm	Lts	
P1906P1	65	0,54	30
P1910P1	100	0,77	30

**Polycarbonate lid**  
Tapa policarbonato  
Couvercle Polycarbonate



REF	Mod	
P1100C1	1/1	30
P1200C1	1/2	60
P1300C1	1/3	30
P1400C1	1/4	30
P1600C1	1/6	60
P1900C1	1/9	30

**Polinorm® Lid**  
Tapa Polinorm®  
Couvercle Polinorm®

**PATENTED EXCLUSIVE**



REF	Mod	
P1100 + COLOR	1/1	30
P1200 + COLOR	1/2	60
P1300 + COLOR	1/3	30
P1400 + COLOR	1/4	30
P1600 + COLOR	1/6	60
P1900 + COLOR	1/9	30

Ref. colour lid  
Ref. color tapa  
Ref. couleur couvercle



**P6** Available for 1/1, 1/2, 1/3 and 1/6  
Disponible para 1/1, 1/2, 1/3 y 1/6  
Disponible pour 1/1, 1/2, 1/3 et 1/6

# 7.8 Violet Collection



## VIOLET COLLECTION

-40 °C  
+110 °C

Use to store bulk products and ingredients in coolers, freezers or pantry. Highly recommended for transportation and micro-waves cooking.

Utilización: almacenamiento de productos a granel, ingredientes varios en neveras o cámaras frigoríficas. Ideal para transporte y cocción en microondas.

Utilisation: stockage de produits et ingrédients en vrac dans des unités réfrigérées ou placards. Idéal pour le transport et la cuisson en four micro-ondes.

**Gastronorm containers**  
Cubetas Gastronorm  
Bacs Gastronorme



**Polinorm® Lid**  
Tapa Polinorm®  
Couvercle Polinorm®



**P6** Ref. colour lid  
Ref. color tapa  
Ref. couleur couvercle

Adjustable to St/Steel, PC, Bisphenol-A FREE and PP GN containers. Not for SP3 range.

Adaptable a cubetas GN inox, PC, sin Bisfenol-A y PP. No aptas para la gama SP3.

Adaptable à bacs GN inox, PC, sans Bisphénol-A et PP. Pas pour la gamme SP3.

REF	Type / Tipo	H mm	Lts	☐
P1115P6	1/1	150	19,60	1
P1215P6	1/2	150	8,70	1
P1315P6	1/3	150	5,00	1
P1615P6	1/6	150	1,95	1

REF	Mod	☐
P1100P6	1/1	30
P1200P6	1/2	60
P1300P6	1/3	30
P1600P6	1/6	60



GN CONTAINERS  
CUBETAS GN  
BACS GN

GN CONTAINERS  
CUBETAS GN  
BACS GN

# 8 Food delivery

Transporte de alimentos  
Transport d'aliments



## 8.1 EPP BOX 212

CAJA PPE  
BOÎTE PPE

## 8.2 INSULATED DELIVERY BAGS 214

BOLSAS DE REPARTO  
SACS DE LIVRAISON ISOTHERMES

**Pizza Bags** / Bolsas para pizza / Sacs à pizzas 214

**Catering Bags** / Bolsas de catering / Sacs de traiteur / 216

**Delivery Backpacks** / Mochila de reparto / Sacs à dos de livraison 218

## 8.3 TRAYS AND CONTAINERS 220

BANDEJAS Y RECIPIENTES  
PLATEAUX ET RÉCIPIENTS

# EPP box 8.1

Caja PPE

Boîte PPE

**Manufactured in expanded polypropylene (EPP) allowing cold and heat to be maintained for hours**

*Fabricado en polipropileno expandido (PPE) permite la conservación del frío y el calor durante horas*

*Fabriqué en polypropylène expansé (PPE) qui permet la conservation du froid et de la chaleur pendant plusieurs heures*

**Inner slot for easy insertion of containers**

*Ranura interior para fácil inserción de cubetas*  
*Rainure intérieure pour une installation facile des bacs*

**Superior load, GN 1/1**

*Carga superior, 1/1 GN*  
*Charge supérieure, 1/1 GN*

**Inset handles on the sides**

*Asas encastradas en los laterales*  
*Anses encastrées sur les côtés*

**100% recyclable**

*100% reciclable*  
*100 % recyclable*

**Foldable to make storage and transport easier**

*Plegable para facilitar el almacenaje y el transporte*  
*Pliable pour faciliter le stockage et le transport*



**P99001 Foldable EPP box**

*Caja plegable PPE*

*Boîte pliable EPP*



REF	W x D x H cm	Inner sizes Dim int / Dim. int. cm	Lt	GN	
P99001	60 x 40 x 25	53,8 x 33,8 x 20	38	1/1	1

## 8.2 Pizza Bags

Bolsas para pizza  
Sacs à pizzas

**Transparent pocket**  
Bolsillo transparente  
Poche transparente

**Reinforced handles for ease of transport**  
Asas reforzadas para fácil transporte  
Anses renforcées pour un transport facile

**Thermal insulation to maintain the temperature**  
Aislamiento térmico para conservar la temperatura  
Isolation thermique pour conserver la température

**Band to be able hang the bag**  
Cinta para poder colgar la bolsa  
Bande pour pouvoir accrocher le sac

**Thick, sturdy and easy to clean material**  
Material grueso y resistente fácil de limpiar  
Matériau épais et résistant, facile à nettoyer



**P9902 Pizza Bags**  
Bolsas para pizza  
Sacs à pizzas



P99021



P99020



REF	W x D x H cm	
P99020	45 x 45 x 16	1
P99021	49,5 x 49,5 x 26	1

## Pizza Bags 8.2

Bolsas para pizza  
Sacs à pizzas

**Transparent pocket with zipper**  
Bolsillo transparente con cremallera  
Poche transparente avec fermeture Éclair

**Thermal insulation to maintain the temperature**  
Aislamiento térmico para conservar la temperatura  
Isolation thermique pour conserver la température

**Reinforced handles for ease of transport**  
Asas reforzadas para fácil transporte  
Anses renforcées pour un transport facile

**Band to be able hang the bag**  
Cinta para poder colgar la bolsa  
Bande pour pouvoir accrocher le sac

**Reflective piping for safer night time delivery**  
Ribetes reflectantes para un reparto nocturno más seguro  
Passepoil réfléchissant pour des livraisons plus sûres la nuit

**Moisture-resistant outer shell**  
Carcasa exterior resistente a la humedad  
Enveloppe extérieure résistant à l'humidité



**VPB Pizza Bags**  
Bolsas para pizza  
Sacs à pizzas



VPB118  
**18" Pizza bag**  
Bolsa para pizza, 18"  
Sac à pizzas, 18"



VPB116  
**16" Pizza bag**  
Bolsa para pizza, 16"  
Sac à pizzas, 16"



REF	Serie	W x D x H cm	
VPB116	SERIE 1	44,5 x 44,5 x 22,9	1
VPB118	SERIE 1	48,3 x 48,3 x 22,9	1

## 8.2 Catering Bags

Bolsas de catering  
Sacs de traiteur



### P9903 Catering bags

Bolsas de catering  
Sacs de traiteur



P99031



P99030

REF	W x D x H cm	GN	
P99030	38 x 30,5 x 38	1/2	1
P99031	56 x 36 x 36	1/1	1

## Catering Bags 8.2

Bolsas de catering  
Sacs de traiteur

**Polyester lining easy to clean**  
Interior de poliéster fácil de limpiar  
Intérieur en polyester facile à nettoyer

**Reflective piping for safer night time delivery**  
Ribetes reflectantes para un reparto nocturno más seguro  
Passepoil réfléchissant pour des livraisons plus sûres la nuit

**Moisture-resistant outer shell**  
Carcasa exterior resistente a la humedad  
Enveloppe extérieure résistant à l'humidité

**Thermal insulation to maintain the temperature**  
Aislamiento térmico para conservar la temperatura  
Isolation thermique pour conserver la température

**Transparent pocket**  
Bolsillo transparente  
Poche transparente

**Reinforced handles for ease of transport**  
Asas reforzadas para fácil transporte  
Anses renforcées pour un transport facile

### VCB Catering bags

Bolsas de catering  
Sacs de traiteur



VCBL100



VCBM100

REF	Serie	W x D x H cm	
VCBM100	SERIE 1	43,2 x 33 x 33	1
VCBL100	SERIE 1	58,4 x 38,1 x 35,6	1



# Delivery Backpacks 8.2

Mochila de reparto  
Sacs à dos de livraison

## VTB Tower bags Bolsas torre Sacs-Tours

**Tower bag with backpack straps and headrest strap**  
Bolsa tipo torre con asas de mochila y correa de reposacabezas  
Sac-tour avec bretelles de sac à dos et sangle d'appui-tête



REF	Serie	W x D x H cm	📦
VTB300	SERIE 3	45,7 x 55,9 x 43,2	1
VTB50002	SERIE 5	45,7 x 55,9 x 43,2	1

## VDBBM Food delivery backpack bags Mochila reparto de alimentos Sacs à dos de livraison d'aliments

**Food delivery backpack bag with integrated frame**  
Bolsa mochila con bastidor integrado para reparto de alimentos  
Sac à dos de livraison d'aliments à armature intégrée



REF	Serie	W x D x H cm	📦
VDBBM300	SERIE 3	40,6 x 40,6 x 33	1
VDBBM50002	SERIE 5	40,6 x 40,6 x 33	1

## ACCESSORIES / ACCESORIOS / ACCESSOIRES

### VTBWR-1 Wire insert Estructura metálica Structure métallique



REF	📦
VTBWR-1	1

**Accessory not included**  
Accesorio no incluido  
Accessoire non inclus



### Bags & wire inserts fold easily for compact storage

Las bolsas y los insertos de alambre se pliegan fácilmente para un almacenamiento compacto

Les sacs et les inserts métalliques se plient facilement pour un rangement compact



### Serie 3

The baseline of warmth ingenuity. The hot food generates heat in the bag while the high performance insulation helps retain the heat, keeping food as warm as it is delicious.  
INCLUDES: Bag

La pauta de referencia del ingenio térmico.  
La comida caliente genera calor en la bolsa mientras que el aislamiento de alto rendimiento ayuda a retenerlo, manteniendo la comida caliente y deliciosa.  
INCLUYE: Bolsa

La référence en matière d'ingénierie. Les aliments chauds dégagent de la chaleur dans le sac tandis que l'isolant ultra-performant la conservent, tout en gardant les aliments aussi chauds que délicieux.  
INCLUS: Housse de transport



### Serie 5

The next step in our heating bag line features a heat pad that pre-heats the bag. Place your hot food into the pre-heated bag, unplug the heat pad and go. Or use the optional 12V in-car power cord to continually heat the bag during transport.  
INCLUDES: Bag / Heat Pad / adaptor heat pad with plug  
OPTIONAL: 12V In-car power cord

El siguiente nivel en nuestra línea de bolsas de reparto incluye una almohadilla térmica que precalienta la bolsa. Coloque la comida caliente en la bolsa precalentada, desenchufe la almohadilla térmica y listo. O use el cable de alimentación opcional de 12V en el automóvil para calentar continuamente la bolsa durante el transporte.  
INCLUYE: Bolsa / Heat pad / Adaptador heat pad con enchufe  
OPCIONAL: Cable conector coche 12V

Le niveau supérieur dans notre ligne de sacs de livraison incorpore un coussin chauffant qui préchauffe le sac. Placez vos aliments chauds dans le sac préchauffé, débranchez le coussin chauffant et partez faire votre livraison. Ou utilisez le câble d'alimentation 12V en option sur la prise du véhicule pour continuer à chauffer le sac pendant le transport.  
INCLUS: Housse de transport / Corps de chauffe / Adaptateur prise corps de chauffe.  
OPTION: Cordon d'alimentation 12V de voiture



## 8.3 Trays and containers

Bandejas y recipientes  
Plateaux et récipients

**P919001 Polycarbonate tray with 5 compartments**  
Bandeja policarbonato de 5 compartimentos  
Plateau polycarbonate avec 5 compartiments



**Stackable**  
Apilable  
Empilable

**\* For use with Polycarbonate tray only**  
Sólo usar con bandeja de Polycarbonato  
Utiliser uniquement plateau en Polycarbonate

**Dishwasher safe**  
Apto para lavavajillas  
Utilisable au lave-vaisselle

REF	W x D x H cm	
P919001	33 x 33 x 3,5	1
P919002*	cover / tapa / couvercle	1

**P919003 Polypropylene tray with 5 compartments**  
Bandeja polipropileno de 5 compartimentos  
Plateau polypropylène avec 5 compartiments



**Stackable**  
Apilable  
Empilable

**Dishwasher safe**  
Apto para lavavajillas  
Utilisable au lave-vaisselle

REF	W x D x H cm	
P919003	33 x 33 x 3,5	1

**P919 Isothermal tray**  
Bandeja isotérmica  
Plateau Isotherme



**Made of polypropylene with insulating polyurethane without CFC interior.**  
Fabricada en polipropileno con interior aislante de poliuretano. Sin CFC.  
Fabriqué en polypropylène avec intérieur isolant de polyuréthane sans CFC.

**Suitable for flat plate, soup plate, bowl, salad bowl on polycarbonate, chinaware or melamine.**  
Adaptado para plato llano, hondo, bol, fuente rectangular en policarbonato, porcelana o melamina.  
Apte pour assiettes plates, à soupe, bols, ravier, soit en polycarbonate, porcelaine ou melamine.

**Complements not included / Complementos no incluidos**  
Compléments non-inclus

REF	W x D x H cm	
P919000	53 x 37 x 11	1

**See products on**  
Ver productos en / Voir produits en page **P. 256**

**Tray transport trolley**  
Carro transporte bandejas  
Chariot transport plateaux



## Trays and containers 8.3

Bandejas y recipientes  
Plateaux et récipients

**P920 Polycarbonate plates**  
Platos policarbonato  
Assiettes en polycarbonate



P920001

**Dishwasher and microwave safe**  
Apto para lavavajillas y microondas  
Utilisable au lave-vaisselle et micro-ondes

REF	Type / Tipo	Ø cm	H cm	
P920001	Flat / Llano / Plat	20,6	2,9	1
P920002	Soup / Hondo / À soupe	18,5	4,5	1
P920003	Breakfast / Desayuno / Petit déjeuner	17,5	2,5	1

**P921 Double wall polycarbonate bowl with lid**  
Bol doble pared policarbonato con tapa  
Bol polycarbonate double paroi avec couvercle



**Dishwasher safe**  
Apto para lavavajillas  
Utilisable au lave-vaisselle

REF	Ø cm	H cm	Lts	
P921001	12,5	6,8	0,45	1

**P922 Polycarbonate rectangular bowl**  
Fuente rectangular policarbonato  
Ravier rectangulaire en polycarbonate



**Dishwasher and microwave safe**  
Apto para lavavajillas y microondas  
Utilisable au lave-vaisselle et micro-ondes

**\*Rigid lid**  
\*Tapa rígida  
\*Couvercle rigide

REF	W x D x H cm	Lts	
P922000	9,5 x 13,8 x 4,5	0,25	1
P922100*	9,6 x 13,9 x 2,4	-	1

**P923 Polycarbonate breakfast cup**  
Taza desayuno policarbonato  
Tasse petit déjeuner polycarbonate



P923000

P923001



**Dishwasher and microwave safe**  
Apto para lavavajillas y microondas  
Utilisable au lave-vaisselle et micro-ondes

**\*Lid**  
\*Tapa  
\*Couvercle

REF	Ø cm	H cm	Lts	
P923000	9,4	6,8	0,325	1
P923001*	10,0	-	-	1

**P924 Polycarbonate glass**  
Vaso policarbonato  
Verre en polycarbonate



REF	Couleur / Color	Ø cm	H cm	Lts	
P924001		7	10,2	0,25	1
P924002		7	7,0	0,17	1
P924002A		7	7,0	0,17	1
P924002R		7	7,0	0,17	1
P924002V		7	7,0	0,17	1

**- 30 °C Dishwasher safe**  
Apto para lavavajillas  
Utilisable au lave-vaisselle



## 8.3 Trays and containers

Bandejas y recipientes  
Plateaux et récipients

**P8610** Fiberglass fast - food tray  
Bandeja fast - food fibra de vidrio  
Plateau fast - food fibre de verre



REF	cm	
P861045	45,5 x 35,5	12
P861053	53,0 x 32,5	12

**P340** St/steel self - service tray  
Bandeja auto - servicio acero inox  
Plateau self - service acier inox



REF	W x D x H cm	
P340000	46 x 28,5 x 2	1

See products on **P. 240**  
Ver productos en / Voir produits en page

**GN, isothermal trays and plates rack**  
Cesta para bandejas isotérmicas, GN y platos  
Panier pour plateaux isothermes, GN et assiettes



**86100** Polypropylene fast - food trays  
Bandejas fast - food de polipropileno  
Plateaux fast - food en polypropylène



Recyclable  
Recyclable  
Recyclable



REF	Color	cm	
86100	Red	25,4 x 35,6	24
86101	Brown	25,4 x 35,6	24
86103	Purple	25,4 x 35,6	24
86104	Orange	25,4 x 35,6	24
86105	Grey	25,4 x 35,6	24
86106	Light Blue	25,4 x 35,6	24
86107	Dark Blue	25,4 x 35,6	24
86108	Black	25,4 x 35,6	24
86109	Teal	25,4 x 35,6	24
86110	Red	30,5 x 40,6	24
86111	Brown	30,5 x 40,6	24
86113	Purple	30,5 x 40,6	24
86114	Orange	30,5 x 40,6	24
86115	Grey	30,5 x 40,6	24
86116	Light Blue	30,5 x 40,6	24
86117	Dark Blue	30,5 x 40,6	24
86118	Black	30,5 x 40,6	24
86119	Teal	30,5 x 40,6	24
86120	Red	35,6 x 45,7	12
86121	Brown	35,6 x 45,7	12
86123	Purple	35,6 x 45,7	12
86124	Orange	35,6 x 45,7	12
86125	Grey	35,6 x 45,7	12
86126	Light Blue	35,6 x 45,7	12
86127	Dark Blue	35,6 x 45,7	12
86128	Black	35,6 x 45,7	12
86129	Teal	35,6 x 45,7	12

Thick reinforced rim with corner ribs add impact strength. Four stacking lugs speed drying and prevent sticking. Semi-gloss, weave-grain textured finish provides a reduced-slip surface.

El borde grueso reforzado con acanalados en las esquinas añade resistencia a los impactos. Cuatro cuñas de apilado para secar rápidamente y evitar que se peguen entre sí. Acabado texturizado entrelazado semibrillante que aporta una superficie menos resbaladiza.

Rebord reforcé épais avec nervures aux angles pour accroître la résistance aux chocs. Les quatre cales d'empilage accélèrent le séchage et empêchent les plateaux de coller entre eux. La texture tissée semi-brillante apporte une surface moins glissante.

## Trays and containers 8.3

Bandejas y recipientes  
Plateaux et récipients

**P8070** Counter - top cutlery dispenser  
Soporte para bandejas porta - cubiertos  
Support porte - couverts



Compatible: P900000

Cutterly bin not included  
No incluye bandeja porta-cubiertos  
Bac ramasse - couverts non inclus

REF	W x D x H cm	
P80700	52,6 x 51 x 32,8	1

**P8071** Double counter - top cutlery dispenser  
Soporte doble para bandejas porta - cubiertos  
Support double porte - couverts



Compatible: P900000

Cutterly bin not included  
No incluye bandeja portacubiertos  
Bac ramasse - couverts non inclus

REF	W x D x H cm	
P80710	52,6 x 51 x 58	1

**P8072** Counter - top dispenser for 4 GN containers 1/3  
Soporte para 4 cubetas GN 1/3  
Support pour 4 bacs GN 1/3



Cutterly bin not included  
No incluye bandeja portacubiertos  
Bac ramasse - couverts non inclus

REF	W x D x H cm	
P80720	73,8 x 31 x 43	1

**P8073** Counter - top dispenser for 8 GN containers 1/3  
Soporte para 8 cubetas GN 1/3  
Support pour 8 bacs GN 1/3



Cutterly bin not included  
No incluye bandeja portacubiertos  
Bac ramasse - couverts non inclus

REF	W x D x H cm	
P80730	73,8 x 46,5 x 60	1

**P900** 1/1 gastronorm cutlery bin  
Bandeja porta - cubiertos gastronorm 1/1  
Bac ramasse - couverts gastronorme 1/1



REF	W x D x H cm	
P900000	53 x 32,5 x 10	1

Food contact polypropylene  
Polipropileno alimentario  
Polypropylène alimentaire



# 9 Dishwasher racks

*Cestas para vajilla*  
*Casiers à vaisselle*

**9.1 OPEN RACKS** 230  
*CESTAS ABIERTAS*  
*CASIERIS OUVERTS*

**9.2 OPEN ASSEMBLED RACKS** 232  
*CESTAS MONTADAS ABIERTAS*  
*CASIERIS MONTÉS OUVERTS*

**9.3 CLOSED ASSEMBLED RACKS** 234  
*CESTAS MONTADAS CERRADAS*  
*CASIERIS MONTÉS FERMÉS*

**9.4 COMPLEMENTS** 236  
*COMPLEMENTOS*  
*COMPLÉMENTS*

**9.5 PLATE RACKS** 238  
*CESTAS PARA PLATOS*  
*CASIERIS ASSIETTES*

**Easy assembly and disassembly system.**  
*Sistema de montaje y desmontaje fácil.*  
Système de montage et démontage facile.

**OPEN - WASHING**  
*ABIERTA - LAVADO*  
*OUVERT - LAVAGE*

**Faster wash and rinse.**  
*Limpeza y secado rápido.*  
Lavage et séchage plus rapide.

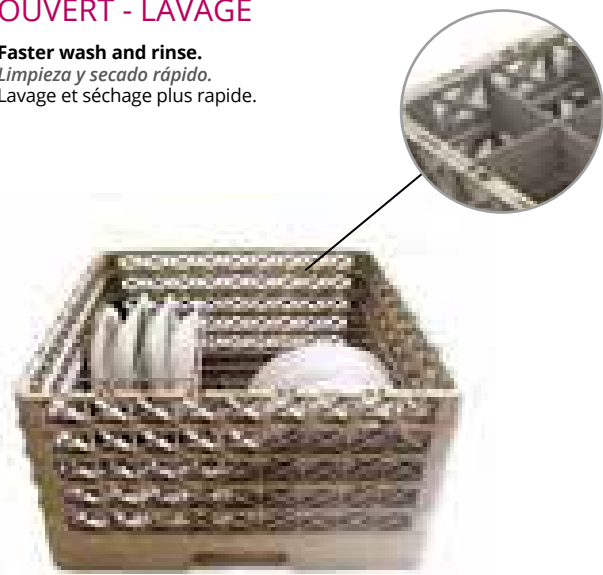

**Stackable with other brands of racks, reinforced double-wall (anti-shock).**

*Apilables con otras cestas del mercado, refuerzo de doble pared (anti-golpes).*

Empilables avec d'autres casiers du marché, renfort avec double paroi (anti-choc).

**CLOSED - TRANSPORT**  
*CERRADA - TRANSPORTE*  
*FERMÉ - TRANSPORT*

**More safety and hygienic storing and transporting.**  
*Almacenamiento y transporte más seguro e higiénico.*  
Stockage et transport plus sûr et hygiénique.



**GET THE BEST OF BOTH WORLDS\***  
*ESCOGER LO BUENO Y LO MEJOR A LA VEZ\**  
*LE BON ET LE MEILLEUR À LA FOIS\**

**FLAP-RACK®: easy to assemble / disassemble**  
*FLAP-RACK®: fácil montaje / desmontaje*  
FLAP-RACK®: facile à monter / démonter

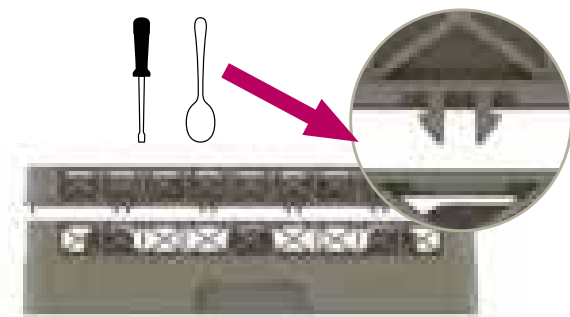

\* Copolymer highly resistant to chemical products and temperatures up to 95 °C.  
\* Copolímero altamente resistente a sustancias químicas y temperaturas de hasta 95 °C.  
\* Copolymère très résistant aux produits chimiques et à températures jusqu'à 95 °C.

**SQUARE COMPARTMENTS**  
*COMPARTIMENTOS CUADRADOS*  
*COMPARTIMENTS CARRÉS*



**System patented allows the walls on both bases and extenders to be closed or open easily**

*Sistema patentado que permite cerrar y abrir las paredes de las cestas y extensiones fácilmente*

Système breveté qui permet d'ouvrir ou de fermer facilement les parois des casiers et des réhausses

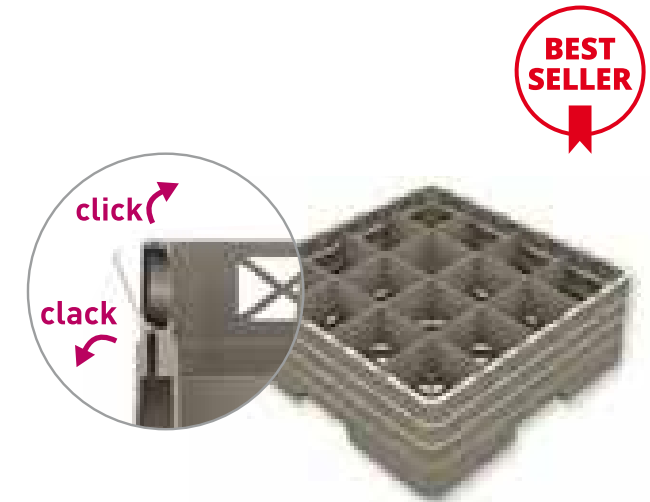

**WASHING: Higher cleaning**  
*LAVADO: Mayor limpieza*  
*LAVAGE: Meilleur nettoyage*



**TRANSPORT: Higher security**  
*TRANSPORTE: Mayor seguridad*  
*TRANSPORT: Plus de sécurité*



**STORING: Higher hygiene**  
*ALMACENAMIENTO: Mayor Higiene*  
*STOCKAGE: Plus hygiénique*

**FLAP IDENTIFICADOR**

**Colour identification for completely closed racks and extensions. Available in 6 colours. Possible customization.**

*Identificador de colores para cestas y extensiones completamente cerradas. Disponible en 6 colores. Posibilidad de marcar logo cliente.*

Identificateur en couleurs pour casiers et réhausses complètement fermés. Disponible en 6 couleurs. Personnalisation possible.

**501F Flap FLAP RACK®**



REF	Colour / Color / Couleur	📦
P501 F1	Brown / Marrón / Marron	24
P501 F2	Burgundy / Burdeos / Bordeaux	24
P501 F3	Blue / Azul / Bleu	24
P501 F4	Yellow / Amarillo / Jaune	24
P501 F5	Green / Verde / Vert	24
P501 F6	Dark brown / Marrón oscuro / Marron foncé	24



**Printed logo or text / Logo o texto impreso / Logo ou texte imprimé**



**Hot stamped logo or text / Logo o texto estampado / Logo ou texte gravé**

# T-VERSION

DESIGNED TO HOLD 17-30% MORE GLASSWARE THAN A TRADITIONAL RACK

DISEÑADAS CON UN 17-30% MÁS DE CAPACIDAD PARA VASOS Y COPAS QUE LAS CESTAS TRADICIONALES

CONÇUS POUR CONTENIR DE 17 À 30 % DE VERRES EN PLUS QU'UN CASIER TRADITIONNEL

## SNAP-FIT EXTENDERS

Will not loosen or come apart over time  
Assembled racks can not be refunded

## EXTENSORES A PRESIÓN

No se sueltan con el tiempo  
No se aceptan devoluciones de cestas montadas

## RÉHAUSSES CLIPSABLES

Sans détachements au fil du temps  
Tout retour de casiers montés n'est pas accepté

## SMALL SIDE COMPARTMENTS

hold flatware, salt shakers, ramekins, ...

LOS COMPARTIMENTOS LATERALES PEQUEÑOS aceptan cubiertos, saleros, potes, ...

## PETITS COMPARTIMENTS LATÉRAUX

pour couverts, salières, ramequins, ...

## OPEN PROFILE DESIGN

Allows top-to-bottom and side-to-side washing and drying

## DISEÑO DE PERFIL ABIERTO

Permite un lavado y secado de arriba a abajo y de lado a lado

## CONCEPT À PROFIL OUVERT

Permet un lavage et un séchage de haut en bas et d'un côté à l'autre

## CONVENIENT HANDLING With handles in all four sides

MANEJO CÓMODO Con asas en los cuatro lados  
MANIPULATION PRATIQUE Grâce aux poignées des quatre côtés

## BUILT-IN BASE RACK DIVIDERS provide 100% vertical glassware protection

LOS DIVISORES INCORPORADOS brindan una protección 100% vertical de los vasos y las copas  
LES PARTITIONS DE CASIER DE BASE INTÉGRÉES offrent une protection des verres 100% verticale

## COLOUR IDENTIFICATION CLIP for easy identification

CLIPS DE IDENTIFICACIÓN DE COLORES para facilitar la identificación  
CLIPS IDENTIFICATEURS EN COULEURS pour une identification plus facile

## HEXAGONAL COMPARTMENTS COMPARTIMENTOS HEXAGONALES COMPARTIMENTS HEXAGONAUX

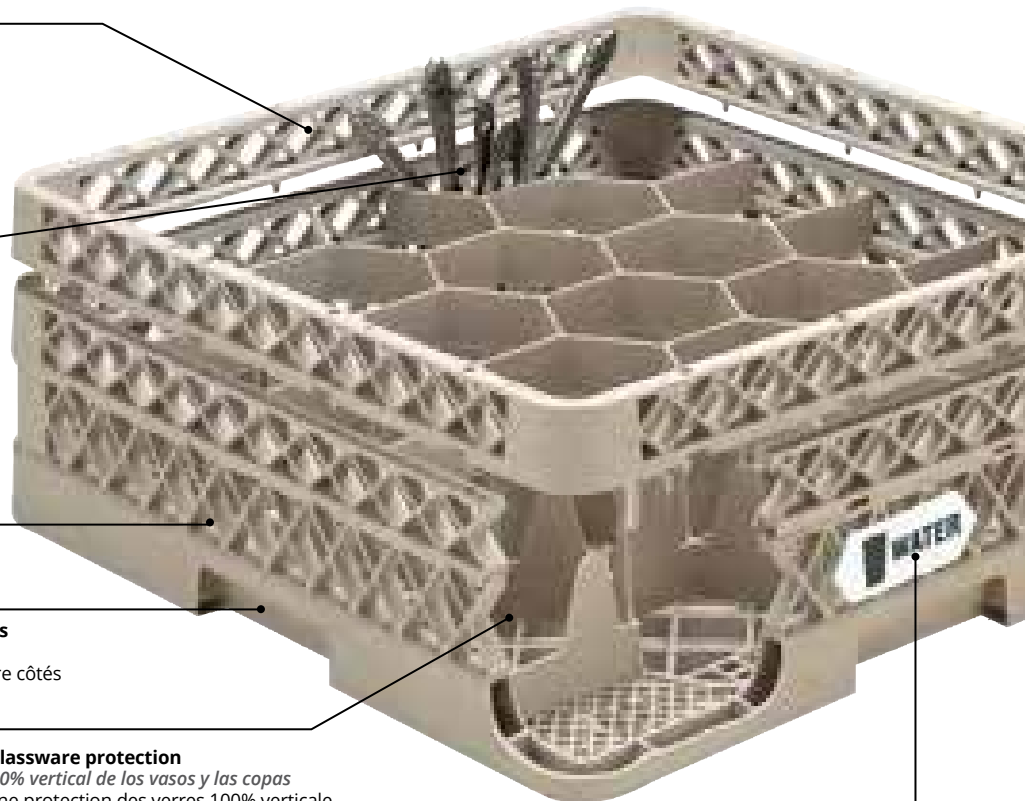

## T-VERSION

### CLIP Clip tags / Clip identificación / Clip d'identification

REF	Colour / Color	Icon
1009-01	Brown	12
1009-02	Red	12
1009-03	Orange	12
1009-04	Blue	12
1009-05	White	12
1009-06	Black	12
1009-08	Yellow	12
1009-19	Green	12
1009-32	Beige	12

01	Brown / Marrón	06	Black / Negro
02	Red / Rojo	08	Yellow / Amarillo
03	Orange / Naranja	19	Green / Verde
04	Blue / Azul	32	Beige / Beige
05	White / Blanco		

# Dishwasher racks selection

Selección cestas para vajilla  
Sélection casiers à vaisselle



## FLAP RACK®

## T-VERSION

### FLAPS



### CLIP TAGS

CLIP IDENTIFICACIÓN  
CLIP D'IDENTIFICATION



### OPENED RACKS

CESTAS ABIERTAS  
CASIEROS OUVERTS



### CLOSED RACKS

CESTAS CERRADAS  
CASIEROS FERMÉES



### HALF-SIZE RACKS

CESTAS MEDIO TAMAÑO  
CASIEROS DEMI-TAILLE



### DISASSEMBLY

DESMONTABLE  
DÉMONTABLE



### COMPARTMENTS

COMPARTIMENTOS  
COMPARTIMENTS



### COMPARTMENTS

COMPARTIMENTOS  
COMPARTIMENTS



# 9.1 Open racks

Cestas abiertas  
Casiers ouverts



∅ max. 151 mm

**FLAP RACK**



**P5090**  
BASE 9 COMPART.

**P5091**  
EXT. 9 COMPART.

REF	
P5090	6
P5091	12

∅ max. 122 mm

**T-VERSION**



**TR18**  
BASE 12 COMPART.

**TRJ**  
EXT. 12 COMPART.

REF	
TR18	6
TRJ	12

∅ max. 113 mm

**FLAP RACK**



**P5160**  
BASE 16 COMPART.

**P5161**  
EXT. 16 COMPART.

REF	
P5160	6
P5161	12

∅ max. 100 mm

**T-VERSION**



**TR11**  
BASE 20 COMPART.

**TRG**  
EXT. 20 COMPART.

REF	
TR11	6
TRG	12

∅ max. 89 mm

**FLAP RACK**



**P5250**  
BASE 25 COMPART.

**P5251**  
EXT. 25 COMPART.

REF	
P5250	6
P5251	12

# Open racks 9.1

Cestas abiertas  
Casiers ouverts



∅ max. 81 mm

**T-VERSION**



**TR12**  
BASE 30 COMPART.

**TRH**  
EXT. 30 COMPART.

REF	
TR12	6
TRH	12

∅ max. 73 mm

**FLAP RACK**



**P5360**  
BASE 36 COMPART.

**P5361**  
EXT. 36 COMPART.

REF	
P5360	6
P5361	12

∅ max. 70 mm

**T-VERSION**



**TR13**  
BASE 42 COMPART.

**TRM**  
EXT. 42 COMPART.

REF	
TR13	6
TRM	12

∅ max. 63 mm

**FLAP RACK**



**P5490**  
BASE 49 COMPART.

**P5491**  
EXT. 49 COMPART.

REF	
P5490	6
P5491	12

DISHWASHER RACKS  
CESTAS VAJILLA  
CASIERS VAISSELLE

DISHWASHER RACKS  
CESTAS VAJILLA  
CASIERS VAISSELLE

## 9.2 Open assembled racks

Cestas montadas abiertas  
Casiers montés ouverts



∅ max. 151 mm **9 COMPART.**

**FLAP RACK**



REF	∆lmax. (mm)	H (mm)*	
P5090 E1	120	140	1
P5090 E2	160	180	1
P5090 E3	200	220	1
P5090 E4	240	260	1
P5090 E5	280	300	1

∅ max. 122 mm **12 COMPART.**

**T-VERSION**



REF	∆lmax. (mm)	H (mm)*	
TR18 J	122	140	2
TR18 JJ	162	181	2
TR18 JJJ	200	222	2
TR18 JJJJ	240	262	2
TR18 JJJJJ	279	302	2

∅ max. 113 mm **16 COMPART.**

**FLAP RACK**



REF	∆lmax. (mm)	H (mm)*	
P5160 E1	120	140	1
P5160 E2	160	180	1
P5160 E3	200	220	1
P5160 E4	240	260	1
P5160 E5	280	300	1

∅ max. 100 mm **20 COMPART.**

**T-VERSION**



REF	∆lmax. (mm)	H (mm)*	
TR11 G	122	140	2
TR11 GG	162	181	2
TR11 GGG	200	222	2
TR11 GGGG	240	262	2
TR11 GGGGG	279	302	2

∅ max. 89 mm **25 COMPART.**

**FLAP RACK**



REF	∆lmax. (mm)	H (mm)*	
P5250 E1	120	140	1
P5250 E2	160	180	1
P5250 E3	200	220	1
P5250 E4	240	260	1
P5250 E5	280	300	1

## Open assembled racks 9.2

Cestas montadas abiertas  
Casiers montés ouverts



∅ max. 81 mm **30 COMPART.**

**T-VERSION**



REF	∆lmax. (mm)	H (mm)*	
TR12 H	122	140	2
TR12 HH	162	181	2
TR12 HHH	200	222	2
TR12 HHHH	240	262	2
TR12 HHHHH	279	302	2

∅ max. 70 mm **42 COMPART.**

**T-VERSION**



REF	∆lmax. (mm)	H (mm)*	
TR13 M	52	73	2
TR13 MM	91	114	2
TR13 MMM	130	156	2
TR13 MMMM	172	194	2

∅ max. 73 mm **36 COMPART.**

**FLAP RACK**



REF	∆lmax. (mm)	H (mm)*	
P5360 E1	120	140	1
P5360 E2	160	180	1
P5360 E3	200	220	1
P5360 E4	240	260	1
P5360 E5	280	300	1

∅ max. 63 mm **49 COMPART.**

**FLAP RACK**



REF	∆lmax. (mm)	H (mm)*	
P5490 E1	120	140	1
P5490 E2	160	180	1
P5490 E3	200	220	1
P5490 E4	240	260	1
P5490 E5	280	300	1

\* Total set height  
\* Altura total del conjunto  
\* Hauteur totale ensemble

See products on  
Ver productos en / Voir produits en page

P. 260

Trolley for dishwasher racks  
Carro para cestas  
Chariot pour casiers à vaisselle



## 9.3 Closed assembled racks

Cestas montadas cerradas  
Casiers montés fermés



∅ max. 151 mm

**FLAP RACK**



**P5090 F1**  
BASE 9 COMPART.

**P5091 F1**  
EXT. 9 COMPART.

REF	
P5090 F1	6
P5091 F1	12

∅ max. 89 mm

**FLAP RACK**



**P5250 F1**  
BASE 25 COMPART.

**P5251 F1**  
EXT. 25 COMPART.

REF	
P5250 F1	6
P5251 F1	12

∅ max. 63 mm

**FLAP RACK**



**P5490 F1**  
BASE 49 COMPART.

**P5491 F1**  
EXT. 49 COMPART.

REF	
P5490 F1	6
P5491 F1	12

∅ max. 113 mm

**FLAP RACK**



**P5160 F1**  
BASE 16 COMPART.

**P5161 F1**  
EXT. 16 COMPART.

REF	
P5160 F1	6
P5161 F1	12

∅ max. 73 mm

**FLAP RACK**



**P5360 F1**  
BASE 36 COMPART.

**P5361 F1**  
EXT. 36 COMPART.

REF	
P5360 F1	6
P5361 F1	12

**FLAP RACK**

Indicate the colour code at the end of the reference.  
Indicar el código de color al final de la referencia.  
Indiquer le code de couleur a la fin de la référence.



F1 F2 F3



F4 F5 F6

## Closed assembled racks 9.3

Cestas montadas cerradas  
Casiers montés fermés



∅ max. 151 mm 9 COMPART.

**FLAP RACK**



REF	∏max. (mm)	H (mm)*	
P5090 E1F1	120	140	1
P5090 E2F1	160	180	1
P5090 E3F1	200	220	1
P5090 E4F1	240	260	1
P5090 E5F1	280	300	1

∅ max. 89 mm 25 COMPART.

**FLAP RACK**



REF	∏max. (mm)	H (mm)*	
P5250 E1F1	120	140	1
P5250 E2F1	160	180	1
P5250 E3F1	200	220	1
P5250 E4F1	240	260	1
P5250 E5F1	280	300	1

∅ max. 63 mm 49 COMPART.

**FLAP RACK**



REF	∏max. (mm)	H (mm)*	
P5490 E1F1	120	140	1
P5490 E2F1	160	180	1
P5490 E3F1	200	220	1
P5490 E4F1	240	260	1
P5490 E5F1	280	300	1

∅ max. 113 mm 16 COMPART.

**FLAP RACK**



REF	∏max. (mm)	H (mm)*	
P5160 E1F1	120	140	1
P5160 E2F1	160	180	1
P5160 E3F1	200	220	1
P5160 E4F1	240	260	1
P5160 E5F1	280	300	1

∅ max. 73 mm 36 COMPART.

**FLAP RACK**



REF	∏max. (mm)	H (mm)*	
P5360 E1F1	120	140	1
P5360 E2F1	160	180	1
P5360 E3F1	200	220	1
P5360 E4F1	240	260	1
P5360 E5F1	280	300	1

**FLAP RACK**

\* Total set height  
\* Altura total del conjunto  
\* Hauteur totale ensemble

Indicate the colour code at the end of the reference.  
Indicar el código de color al final de la referencia.  
Indiquer le code de couleur a la fin de la référence.



F1 F2 F3



F4 F5 F6

## 9.4 Complements

Complementos  
Compléments



**P5002** Open rack  
*Cesta universal*  
Panier universel

**FLAP RACK®**

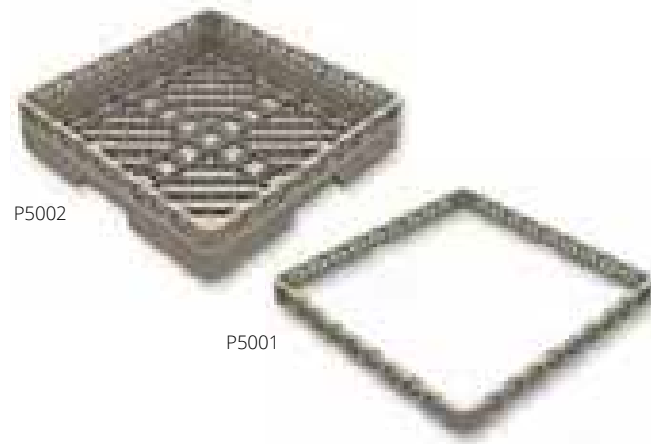

**P5001** Compatible only with FlapRack® dishwasher racks.  
*Compatible sólo con las cestas FlapRack®.*  
Compatible uniquement avec les casiers de lavage FlapRack®.

**TRA\*** Compatible only with T-Version dishwasher racks.  
*Compatible sólo con las cestas T-Version.*  
Compatible uniquement avec les casiers de lavage T-Version.

REF	
P5002	6
P5001	12
TRA*	12

**TR33** Racks lid  
*Tapa para cestas*  
Couvercle pour paniers

**FLAP RACK®**



REF	
TR33	6

**P5000** Plate, tray and cutlery racks  
*Cesta para platos, bandejas y cubiertos*  
Paniers pour plats, plateaux et couverts

**FLAP RACK®**



**P5000** Flatware rack  
*Cesta para cubiertos*  
Panier a couverts

**P5003** Plates and trays rack  
*Cesta para platos y bandejas*  
Panier pour assiettes et plateaux

REF	
P5000	6
P5003	6

**P5062** Rack for cutlery storage  
*Cesta para almacenar cubiertos*  
Panier pour rangement couverts

**FLAP RACK®**

\* Total set height  
*Altura total del conjunto*  
Hauteur totale ensemble



REF		max. (mm)	H (mm)*	Cutlery capacity <i>Capacidad cubiertos</i> Capacité couverts	
P5062		23	26	400	1

## Complements 9.4

Complementos  
Compléments



**52640** 8-Compartment flatware basket  
*Cesta para cubiertos de 8 compartimentos*  
Panier pour couverts 8 compartiments



**NEW!**

REF	W x D x H cm	
52640	46 x 19,6 x 18,5	4

**52642** Plastic vertical flatware cylinder  
*Cestilla para cubiertos en plástico*  
Petit panier pour couverts en plastique

**PI**  
Plastic



**NEW!**

REF	Ø cm	H cm	
52642	11,18	14,3	12

**P5018** 8-compartment flatware basket  
*Media cesta para cubiertos 8 compartimentos*  
Demi-panier pour couverts 8 compartiments

**FLAP RACK®**



REF	W x D x H cm	
P5018 With handle / <i>Con asa / Avec anse</i>	22 x 42,5 x 14,5	1
P5019 Without handle / <i>Sin asa / Sans anse</i>	22 x 42,5 x 14,5	6

**52641** 8-Comp. flatware basket with handles  
*Cesta para cubiertos de 8 compart. con asas*  
Panier pour couverts 8 compartiments avec poignées



**NEW!**

REF	W x D x H cm	
52641	46 x 19,6 x 18,5	4

**99710** Stainless steel vertical flatware cylinder  
*Cestilla para cubiertos en acero inoxidable*  
Petit panier pour couverts inox

**SS**  
Stainless steel

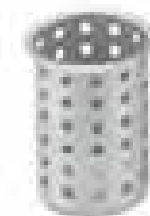

**NEW!**

REF	Ø cm	H cm	
99710	11,4	14,1	12

**P5004** Flatware basket  
*Cestillo para cubiertos*  
Petit panier pour couverts

**PI**  
Plastic

**FLAP RACK®**



REF	W x D x H cm	
P5004	10 x 10 x 14	52
52643	Ø 9,5 x 14,5	12



# 9.5 Plate racks

Cestas para platos  
Casiers assiettes



## FLAP RACK®

**Plate crate: Perfect dish washing, storing and transporting for banquets, hotels, institutions and catering equipment rental companies. They minimize the plate breakage, labour and handling cost.**

*Cestas especiales para platos: Ideales para el lavado, almacenamiento y transporte de platos. Perfectas para banquetes, hoteles, colectividades y empresas de alquiler de material para la hostelería. Reducen las roturas de platos, minimizan el coste del transporte y manipulación.*

Casiers pour assiettes: Idéales pour le lavage, stockage et transport d'assiettes. Parfaits pour banquetes, hôtels, collectivités et sociétés de location de matériel pour l'hôtellerie. Ce type de casiers permet de réduire le nombre d'assiettes cassées ainsi qu'une diminution des coûts de transport et manipulation.

Two types  
Dos modalidades  
Deux modèles

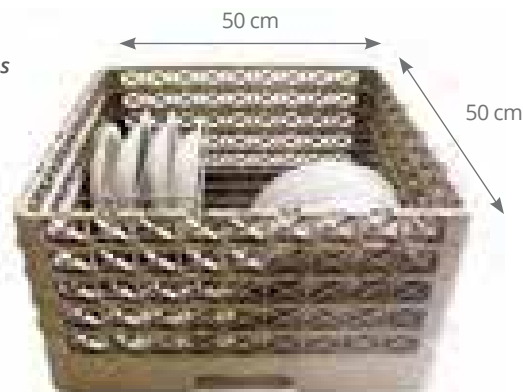

**Faster wash and rinse.**  
Limpieza y secado rápido.  
Nettoyage et séchage plus rapide.



**More safety and hygienic storing and transporting.**  
Almacenamiento y transporte más seguro e higiénico.  
Stockage et transport plus sûr et hygiénique.

Nine different grids  
Nueve formatos de rejilla  
Neuf grilles différentes

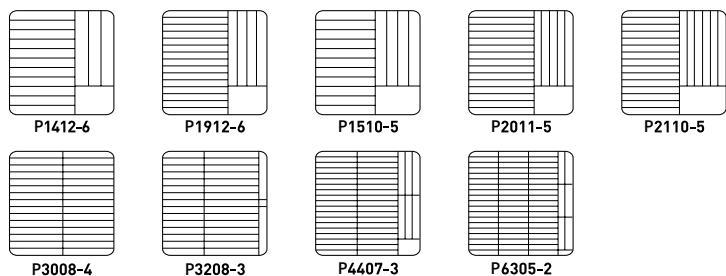

**Extra protection, strength and durability.**  
Mayor protección, resistencia y durabilidad.  
Plus grande protection, résistance et durabilité.

**How to choose the appropriate plate crate:** Measure the plate diameter and height. You have then to choose between the 9 different grids according to the measures you get previously.

*Como elegir la cesta de platos adecuada:* Debe medir el diámetro y altura del plato. Con estos datos escoger, de las 9 combinaciones posibles, aquella que se ajuste más a las medidas del plato.

*Comment choisir le casier pour assiettes:* Mesurer le diamètre et la hauteur de l'assiette. Selon ces mesures choisir entre les 9 possibles combinaisons de grille qui s'adapte au mieux.



# Plate racks 9.5

Cestas para platos  
Casiers assiettes



P1412-6

Ø 27-31 cm

FLAP RACK

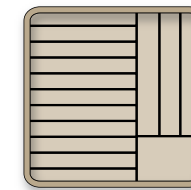

REF	I max. (cm)	Capacity plates Capacidad platos Capacité assiettes	📦
P1412-6	3,5	14	1
P1412-6 F1*	3,5	14	1

P1912-6

Ø 28-30,5 cm

FLAP RACK

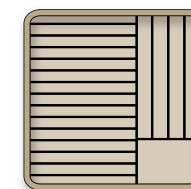

REF	I max. (cm)	Capacity plates Capacidad platos Capacité assiettes	📦
P1912-6	2,5	19	1
P1912-6 F1*	2,5	19	1

P2110-5

Ø 23-25 cm

FLAP RACK

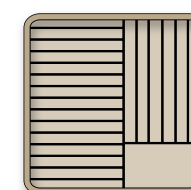

REF	I max. (cm)	Capacity plates Capacidad platos Capacité assiettes	📦
P2110-5	2,5	21	1
P2110-5 F1*	2,5	21	1

P3208-3

Ø 12-19 cm

FLAP RACK

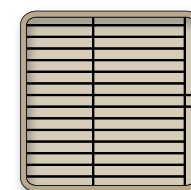

REF	I max. (cm)	Capacity plates Capacidad platos Capacité assiettes	📦
P3208-3	2,5	32	1
P3208-3 F1*	2,5	32	1

P1510-5

Ø 23-28 cm

FLAP RACK

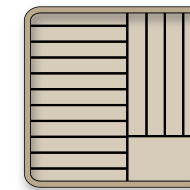

REF	I max. (cm)	Capacity plates Capacidad platos Capacité assiettes	📦
P1510-5	3,5	15	1
P1510-5 F1*	3,5	15	1

P2011-5

Ø 25-28 cm

FLAP RACK

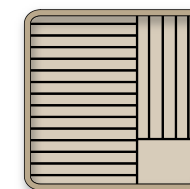

REF	I max. (cm)	Capacity plates Capacidad platos Capacité assiettes	📦
P2011-5	2,5	20	1
P2011-5 F1*	2,5	20	1

P3008-4

Ø 20-22 cm

FLAP RACK

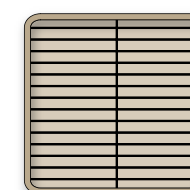

REF	I max. (cm)	Capacity plates Capacidad platos Capacité assiettes	📦
P3008-4	2,5	30	1
P3008-4 F1*	2,5	30	1

FLAP RACK

\* Closed racks  
\* Cestas cerradas  
\* Casiers fermés

Indicate the colour code at the end of the reference.  
Indicar el código de color al final de la referencia.  
Indiquer le code de couleur a la fin de la référence.

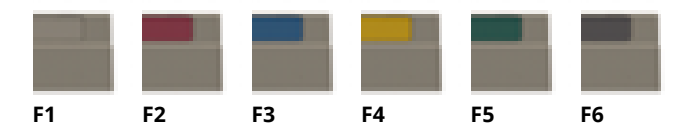

# 9.5 Plate racks

Cestas para platos  
Casiers assiettes



**P4407-3** Ø 15-18 cm

**FLAP RACK**

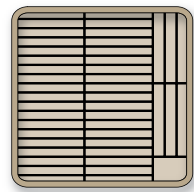

REF	I max. (cm)	Capacity plates Capacidad platos Capacité assiettes	
P4407-3	2	44	1
P4407-3 F1*	2	44	1

**TR23** Open tray rack  
**TR30** Cesta para grandes bandejas  
Panier pour grands plateaux

**T-VERSION**



\* Capacity for 4 full-size extended trays and also for isothermal trays  
Ref. 919000 (page 220)  
Capacidad para 4 bandejas extendidas de tamaño completo y también para bandejas isotérmicas Ref. 919000 (pag 220)  
Capacité pour 4 plateaux longs de grande taille et également pour des plateaux isothermes Réf. 919000 (page 220).

REF	H cm		
	Inside / Interior / Intérieure	Outside / Exterior / Extérieure	
TR23*	13,3	13,3	1
TR30	8,3	10,2	1

**FLAP RACK**

- \* Closed racks  
\* Cestas cerradas
- \* Paniers fermés

Indicate the colour code at the end of the reference.  
Indicar el código de color al final de la referencia.  
Indiquer le code de couleur a la fin de la référence.

**P6305-2** Ø 10-12,8 cm

**FLAP RACK**

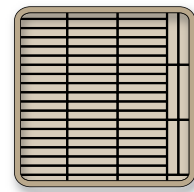

REF	I max. (cm)	Capacity plates Capacidad platos Capacité assiettes	
P6305-2	2,5	63	1
P6305-2 F1*	2,5	63	1

**TR21** GN, isothermal trays and plates rack  
**TR22** Cesta para bandejas isotérmicas, GN y platos  
Panier pour plateaux isothermes, GN et assiettes

**T-VERSION**



**TR21**  
**8 Compartments**  
80 mm Distance between compart.  
No aptas para bandejas isotérmicas  
Not suitable for isothermal trays  
No convient pas aux bacs isothermiques  
Ref. 919000 (pag 220)

**TR22**  
**5 Compartments**  
75 mm Distance between compart.  
No aptas para bandejas isotérmicas  
Not suitable for isothermal trays  
No convient pas aux bacs isothermiques  
Ref. 919000 (pag 220)

Open end rack / Cesta de extremo abierto / Casier ouvert à l'extrémité

REF	H cm		
	Inside / Interior / Intérieure	Outside / Exterior / Extérieure	
TR21	8,3	12,1	1
TR22	13,3	13,3	1

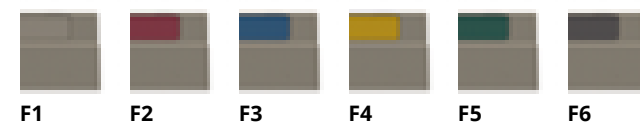

F1 F2 F3 F4 F5 F6

# Reference guide for bases and extensions

Guía de selección para bases y extensiones  
Guide de sélection pour bases et rehauses

**HEIGHT OF FULL-SIZE RACKS**  
ALTURA DE LAS CESTAS DE TAMAÑO COMPLETO  
HAUTEUR DES CASIERS GRANDE TAILLE

**HEIGHT OF HALF-SIZE RACKS**  
ALTURA DE LAS CESTAS DE MEDIO TAMAÑO  
HAUTEUR DES CASIERS DEMI-TAILLE

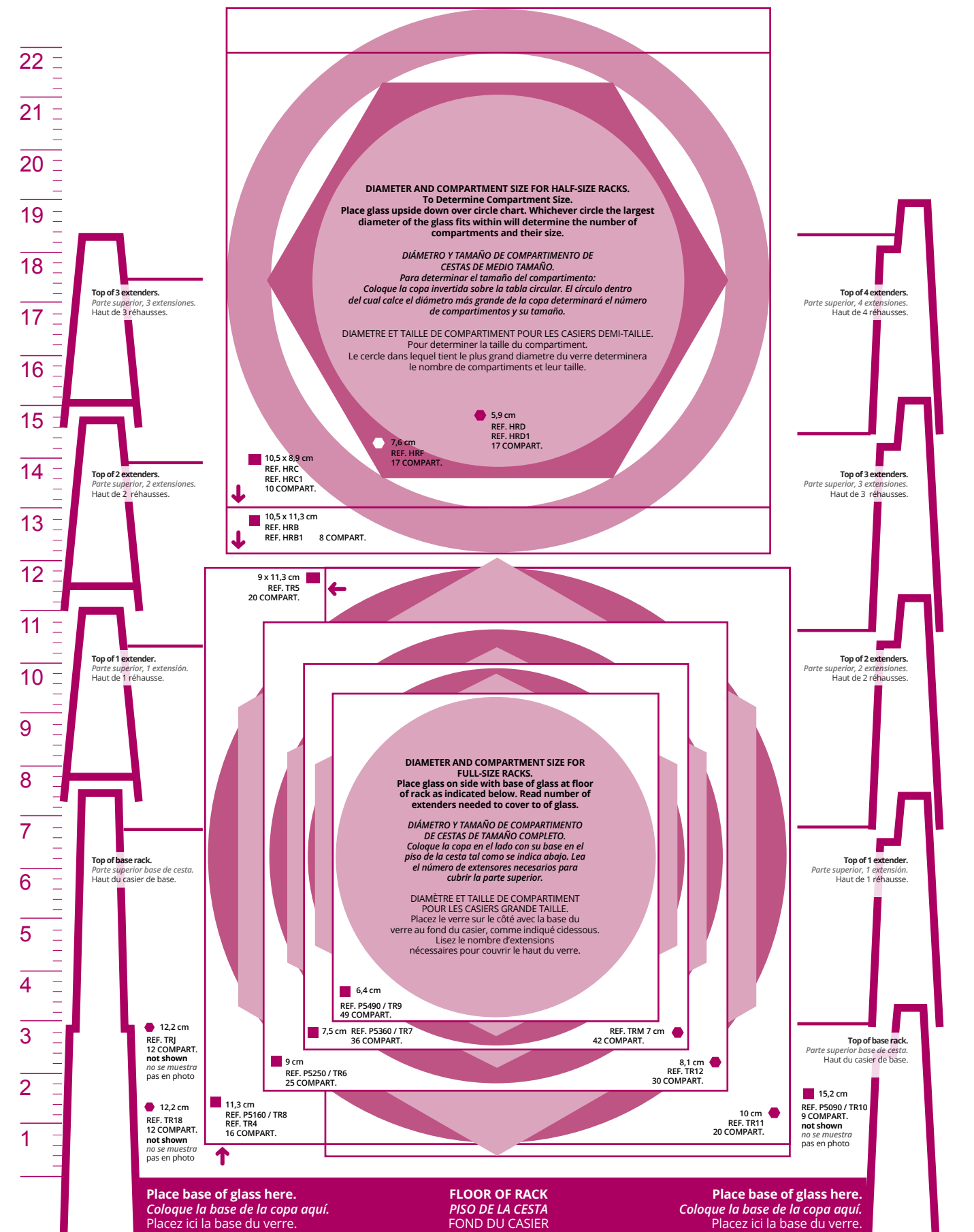

# 10 Trolleys

Carros  
Chariots

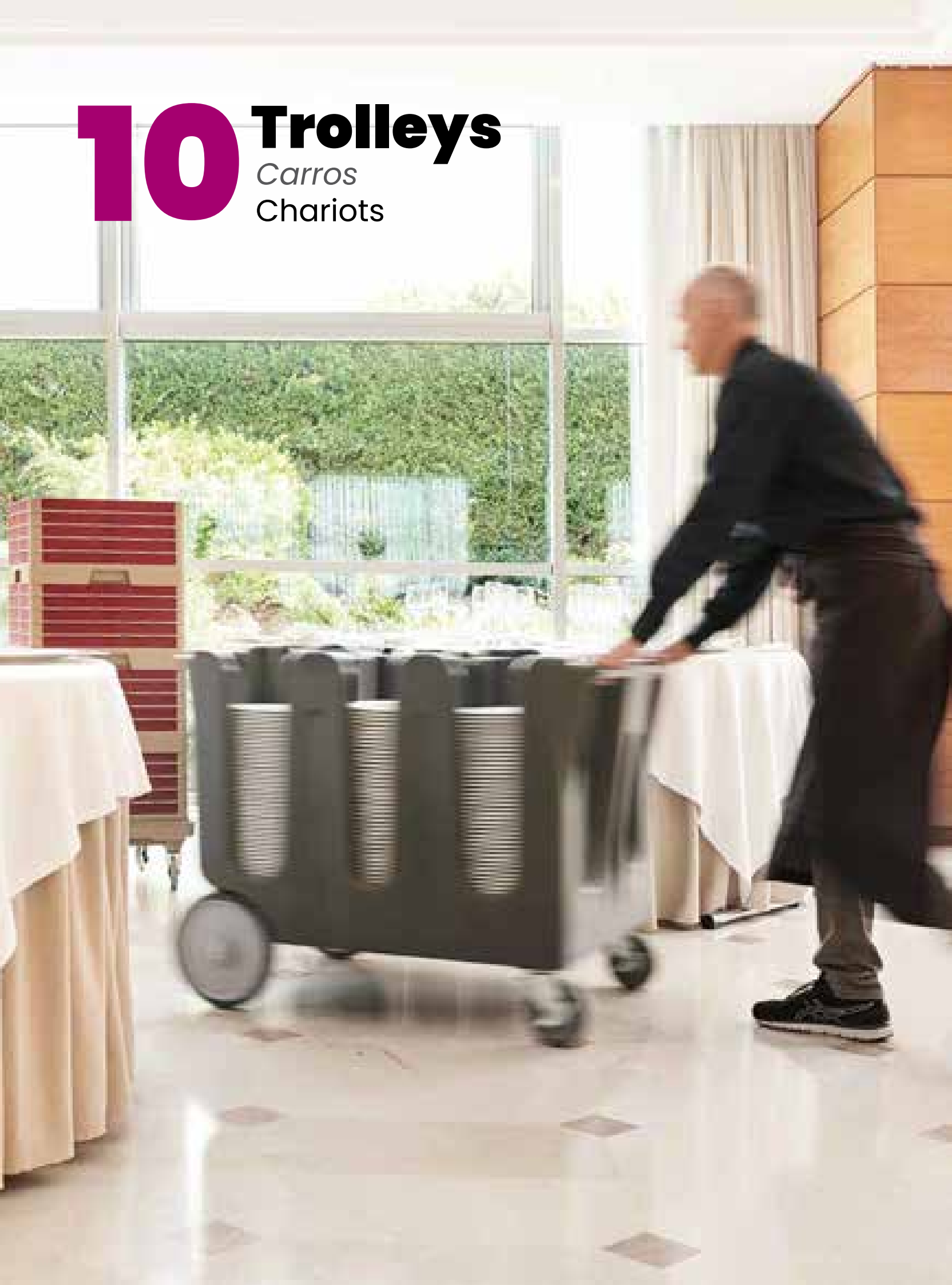

## 10.1 ALUMINIUM SERVING TROLLEYS 244

CARROS DE SERVICIO ALUMINIO  
CHARIOTS DE SERVICE EN ALUMINIUM

## 10.2 ST/STEEL SERVING TROLLEYS 246

CARROS DE SERVICIO ACERO INOXIDABLE  
CHARIOTS DE SERVICE EN ACIER INOXYDABLE

## 10.3 ST/STEEL RAIL TROLLEYS 250

CARROS GUÍAS EN ACERO INOXIDABLE  
CHARIOTS À GLISSIÈRES EN ACIER INOXYDABLE

## 16.4 SPECIAL TROLLEYS 257

CARROS ESPECIALES  
CHARIOTS SPÉCIAUX

# 10.1 Aluminium serving trolleys

Carros de servicio aluminio  
Chariots de service en aluminium

## P6411 Multi purpose cart

Carro de servicio  
Chariot de service



Maximum weight load 120 kgs  
Carga máxima 120 kgs  
Charge maximale 120 kgs

Aluminium supports  
Soportes de aluminio  
Supports en aluminium

REF	Shelf dimension Dim. Estante / Dim. Niveau cm	
P641100	78 x 48,5	1

## P640 Set trolley

Conjunto carro  
Ensemble chariot

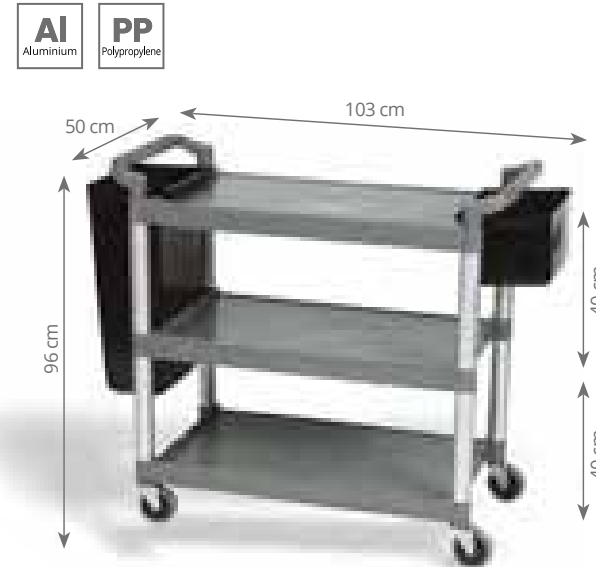

REF	Shelf dimension Dim. Estante / Dim. Niveau cm	
P640000	78 x 48,5	1

## P642 Silverware container

Contenedor para cubiertos  
Conteneur pour couverts

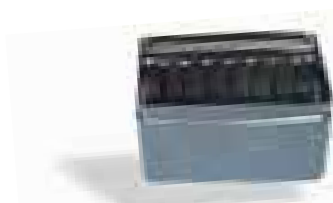

REF	cm	Lts	
P642000	32 x 19,5 x 16,5	9	1

## P643 Refuse container

Contenedor para desperdicios  
Conteneur pour déchets



REF	cm	Lts	
P643000	33,5 x 23 x 56	80	1

# Aluminium serving trolleys 10.1

Carros de servicio aluminio  
Chariots de service en aluminium



## 97006 Multi purpose cart

Carro de servicio  
Chariot de service



Textured shelf surface reduces product shifting  
La superficie texturizada del estante reduce el desplazamiento del producto  
La surface texturée de l'étagère réduit le déplacement du produit

Maximum weight load 135 kgs  
Carga máxima 135 kgs  
Charge maximale 135 kgs

REF	Shelf dimension Dim. Estante / Dim. Niveau cm	W x D x H cm	
97006	66 x 41,3	84 x 43 x 94	1
97007	75 x 49	102,2 x 50,5 x 94	1

## 97004 Multi purpose cart

Carro de servicio  
Chariot de service



Textured shelf surface reduces product shifting  
La superficie texturizada del estante reduce el desplazamiento del producto  
La surface texturée de l'étagère réduit le déplacement du produit

Maximum weight load 135 kgs  
Carga máxima 135 kgs  
Charge maximale 135 kgs

REF	Shelf dimension Dim. Estante / Dim. Niveau cm	W x D x H cm	
97004	66 x 41,3	84 x 43 x 94	1
97005	75 x 49	102,2 x 50,5 x 94	1

EXCLUSIVE

## P8090 Aluminium clearing trolley

Carro aluminio desembarace  
Chariot débarrasage en aluminium



Racks adjustable to 1/1 GN containers and FLAP-RACK® (500 x 500 mm).  
Maximum load: 150 Kg and max. per level 75 Kg.

Medidas de estantes adaptables a cubetas GN 1/1 y cestas FLAP-RACK® (500 x 500 mm). Carga máxima: total 150 Kg y con un máximo de 75 Kg por estante.

Clayettes adaptables à des bacs GN 1/1 et à casiers à vaisselle FLAP-RACK® (500 x 500 mm). Charge maximale: total 150 Kg et 75 Kg par niveau.

REF	Shelf dimension Dim. Estante / Dim. Niveau cm	
P80900	87 x 55,5	1

## 10.2 St/steel serving trolleys

Carros de servicio acero inoxidable  
Chariots de service en acier inoxydable



### P8024 St/steel serving trolley

Carro servicio acero inox  
Chariot service en acier inox

**BEST SELLER**

#### 1.5 mm thick St/Steel tubular frame

Estructura tubular en acero inox de 1.5 mm espesor  
Structure tubulaire en acier inoxydable 1.5 mm. épaisseur

**Total maximum load 240 kg.  
Max. load per level 80 kg**

Carga máxima total 240 KG.  
Carga máxima por estante 80 kg  
Charge maximale total 240 kg.  
Charge maximale per niveau 80 kg

**12 cm diam. Revolving casters.  
Two with brakes**

Ruedas giratorias de 12 cm diámetro. Dos con frenos  
Roues giratoires de 12 cm diam.  
Deux avec freins



Available also on polyamide castors.

Disponible también con ruedas poliamida.

Disponible aussi avec roulettes polyamide.

REF	Levels Estantes Niveaux	Shelf dimension Dim. Estante / Dim. Niveau cm	W x D x H cm	1
P80240	2	80 x 50	88 x 58 x 101,5	1
P80250	2	90 x 50	98 x 58 x 101,5	1
P80260*	2	100 x 60	108 x 68 x 101,5	1
P80270	3	80 x 50	88 x 58 x 101,5	1
P80280	3	90 x 50	98 x 58 x 101,5	1
P80290*	3	100 x 60	108 x 68 x 101,5	1
P80300	4	80 x 50	88 x 58 x 130	1
P80310	4	90 x 50	98 x 58 x 130	1
P80320*	4	100 x 60	108 x 68 x 130	1

\* Thicker shelves  
Estantes de chapa de mayor espesor  
Plateaux plus épais

### P80374 Cutlery dispenser for serving trolley

Cubertero para carro servicio  
Ramasse-couverts pour chariot service



REF	Mod	H cm	1
P80374	GN 1/3	15	1

### P8068 St/Steel clearing trolley

Carro desembarace inox  
Chariot de débarrassage en inox



Available also on polyamide castors.  
Disponible también con ruedas poliamida.  
Disponible aussi avec roulettes polyamide.

**1/2 Gastronorm container not included.**

No incluye cubeta Gastronorm 1/2.  
Bac Gastronorme 1/2 non inclus.  
Ø 165 mm

REF	Levels Estantes Niveaux	Shelf dimension Dim. Estante / Dim. Niveau mm	1
P80680	2	1.000 x 600	1

## St/steel serving trolleys 10.2

Carros de servicio acero inoxidable  
Chariots de service en acier inoxydable



### P80282 Paneled serving trolley

Carro servicio panelado  
Chariot service panelé



REF	Shelf dimension Dim. Estante / Dim. Niveau cm	1
P80282	90 x 50	1

#### 1.5 mm thick St/Steel tubular frame

Estructura tubular en acero inox de 1.5 mm espesor  
Structure tubulaire en acier inoxydable 1.5 mm. épaisseur

**Paneled  
Panelado  
Panelé**



**Total maximum load 240 kg  
Max. load per level 80 kg**

Carga máxima total 240 kg  
Carga máxima por estante 80 kg  
Charge maximale total 240 kg  
Charge maximale per niveau 80 kg

**12 cm diam. Revolving casters.  
Two with brakes**

Ruedas giratorias de 12 cm diámetro. Dos con frenos  
Roues giratoires de 12 cm diam.  
Deux avec freins

### 97181 Bussing cart

Carro de transporte  
Chariot de transport

**NEW!**



REF	Shelf dimension Dim. Estante / Dim. Niveau cm	1
97181	69 x 45	1

**Bins not included  
Cubetas no incluidas  
Bacs non inclus.**

**Durable stainless steel construction and ABS handle provide years of service.**

La construcción duradera de acero inoxidable y el mango de ABS proporcionan años de servicio.

La construction durable en acier inoxydable et la poignée en ABS offrent des années de service.

**Black vinyl finish creates an attractive appearance**

El acabado de vinilo negro crea un aspecto atractivo

La finition en vinyle noir crée un look attrayant

**Strong swivel casters ensure swift maneuvering**

Las ruedas giratorias fuertes garantizan una maniobra rápida  
Des roues pivotantes robustes garantissent une manœuvre rapide

## 10.2 St/steel serving trolleys

Carros de servicio acero inoxidable  
Chariots de service en acier inoxydable

SS  
Stainless  
steel



**Total maximum load 240 kg.  
Max. load per level 80 kg**

Carga máxima total 240 KG.  
Carga máxima por estante 80 kg  
Charge maximale total 240 kg.  
Charge maximale per niveau 80 kg

**12 Cm diam. Revolving casters. Two with brakes**  
Ruedas giratorias de 12 cm diámetro. Dos con frenos  
Roues giratoires de 12 cm diam. Deux avec freins



**P8033 Disassembled trolley**  
Carro desmontable  
Chariot démontable



ASSEMBLY  
MONTAJE  
MONTAGE



Muy robustos y sólidos  
**Very strong and resistant once assembled**  
Très robustes et solides une fois montés

Se entregan desmontados.  
**Delivered flatpacked.**  
Livrés démontés.

REF	Levels Estantes Niveaux	Shelf dimension Dim. Estante Dim. Niveau cm	W x D x H cm	📦
P80330	2	80 x 50	81 x 54,5 x 104	1
P80340	2	90 x 50	91 x 54,5 x 104	1
P80350	3	80 x 50	81 x 54,5 x 104	1
P80360	3	90 x 50	91 x 54,5 x 104	1

**P8096 Light disassembled trolley**  
Carro desmontable ligero  
Chariot démontable légère



Ruedas acero Ø 100 mm. Dos con freno.  
**Castors Ø 100 mm. Two with brakes.**  
Roulettes Ø 100 mm. Deux avec freins.

**ECONOMIC LINE  
GAMA ECONÓMICA  
GAMME ECONOMIQUE**

REF	Levels Estantes Niveaux	Shelf dimension Dim. Estante Dim. Niveau cm	W x D x H cm	📦
P80960	2	83 x 51	93 x 61 x 93,5	1
P80961	3	83 x 51	93 x 61 x 93,5	1

## St/steel serving trolleys 10.2

Carros de servicio acero inoxidable  
Chariots de service en acier inoxydable

SS  
Stainless  
steel

**P8094 Serving trolley with guard-rail shelf**  
Carro servicio con barandilla  
Chariot service avec galerie



Available also on polyamide castors. Please ask for price  
Disponible también con ruedas poliamida. Consultar precio  
Disponible aussi avec roulettes polyamide. Consulter prix

REF	Levels Estantes Niveaux	Shelf dimension Dim. Estante Dim. Niveau cm	W x D x H cm	📦
P80940	2	80 x 50	88 x 58 x 101,5	1
P80941	3	80 x 50	88 x 58 x 101,5	1

**97168 Three-shelf tubular cart**  
Carro tubular de 3 estantes  
Chariot tubulaire à 3 étagères



**NEW!**

**97208 Three-shelf heavy-duty stainless steel cart**  
Carro de servicio de 3 niveles  
Chariot service à trois étagères



**NEW!**

**400 kg capacity is distributed between the shelves. Two 10 cm wivel casters and two 20 cm front wheels ensure swift maneuvering. Extended-height stainless steel handles feature a comfort coating.**

La capacidad de 400 kg se distribuye entre las estanterías. Dos ruedas giratorias de 10 cm y dos ruedas delanteras de 20 cm garantizan una maniobra rápida. Los mangos de acero inoxidable de altura extendida cuentan con un revestimiento de confort.

La capacité de 400 kg est répartie entre les rayonnages. Deux roues pivotantes de 10 cm et deux roues avant de 20 cm garantissent une manœuvre rapide. Les poignées en acier inoxydable à hauteur prolongée sont dotées d'un revêtement de confort.

REF	Shelf dimension Dim. Estante Dim. Niveau cm	📦
97208	89 x 58,4	1

REF	Shelf dimension Dim. Estante Dim. Niveau cm	📦
97168	85 x 54	1

# 10.3 St/steel rail trolleys

Carros guías en acero inoxidable  
Chariots à glissières en acier inoxydable



**P8043** 17 rails trolley for GN pans  
Carro 17 guías GN  
Chariot 17 glissières pour bacs GN

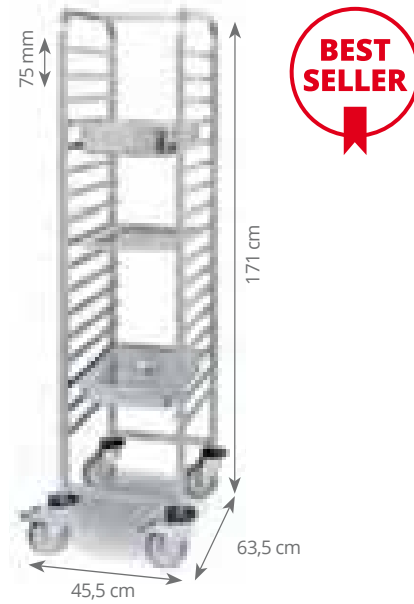

Available also on polyamide castors. Please ask for price.  
Disponibile también con ruedas poliamida. Consultar precio.  
Disponible aussi avec roulettes polyamide. Consulter prix.

REF	Entrance / Entrada / Entré cm	
P80430	32,5	1

**P8067** Double rail trolley 17 x 2 for 1/1 GN pans  
Carro doble 17 x 2 guías 1/1  
Chariot double 17 x 2 glissières pour bacs GN 1/1



Available also on polyamide castors. Please ask for price.  
Disponibile también con ruedas poliamida. Consultar precio.  
Disponible aussi avec roulettes polyamide. Consulter prix.

REF	Entrance / Entrada / Entré cm	
P80670	32,5	1

**P80641** Disposable trolley covers dispenser  
Dispensador para fundas de carro  
Distributeur pour housses de chariot



REF		
P80641		1

**P8061** Disposable covers for trolleys  
**P8062** Fundas desechables de polietileno para carros  
**P8063** Housses jetables pour chariots



Pack / Rollo / Rouleau 100 u

Medium density polyethylene. Para high trolleys.  
Polietileno de densidad media. Para carros altos.  
Poliéthylène de densité moyenne. Pour chariots hauts.

REF		
P80610	for trolley 1/1 / para carro 1/1 / pour chariot 1/1	1
P80620	for trolley 2/1 / para carro 2/1 / pour chariot 2/1	1
P80630	for pastry trolley 600 x 400 / para carro pastelería 600 x 400 / pour chariot pâtisserie 600 x 400	1

# St/steel rail trolleys 10.3

Carros guías en acero inoxidable  
Chariots à glissières en acier inoxydable



**P8047** Disassembled trolley 17 rails for GN pans  
Carro desmontable 17 guías GN  
Chariot démontable 17 glissières pour bacs GN

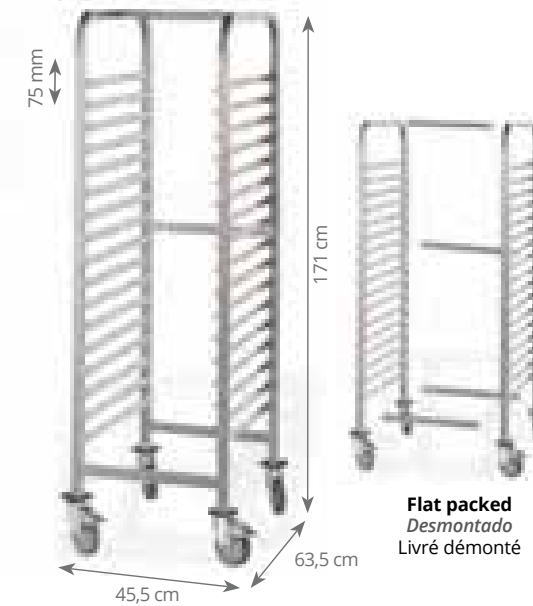

Available also on polyamide castors. Please ask for price.  
Disponibile también con ruedas poliamida. Consultar precio.  
Disponible aussi avec roulettes polyamide. Consulter prix.

REF	Entrance / Entrada / Entré cm	
P80470	32,5	1

**P8097** Light Disassembled trolley 15 rails for GN pans  
Carro desmontable ligero 15 guías GN  
Chariot démontable léger 15 glissières pour bacs GN



Castors Ø 120 mm. Two with brakes.  
Ruedas acero Ø 120 mm. Dos con freno.  
Roulettes Ø 120 mm. Deux avec freins.

ECONOMIC LINE  
GAMA ECONÓMICA  
GAMME ECONOMIQUE

REF	Entrance / Entrada / Entré cm	
P80970	32,5	1

**P8052** Stackable trolley 17 rails for GN pans  
Carro encastrable 17 guías GN  
Chariot emboîtable 17 glissières pour bacs GN

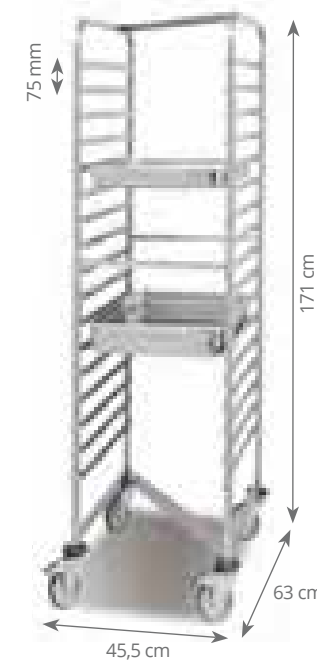

Stackble  
Encastrable  
Emboîtable

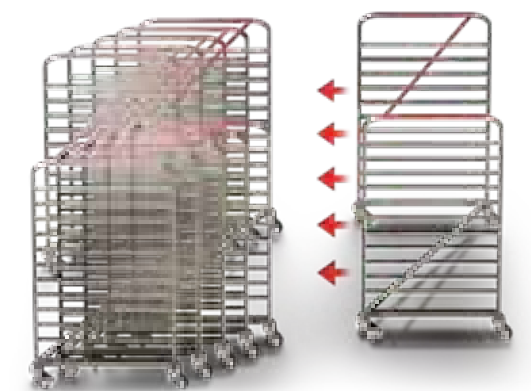

Available also on polyamide castors. Please ask for price.  
Disponibile también con ruedas poliamida. Consultar precio.  
Disponible aussi avec roulettes polyamide. Consulter prix.

REF	Entrance / Entrada / Entré cm	
P80520	32,5	1

# 10.3 St/steel rail trolleys

Carros guías en acero inoxidable  
Chariots à glissières en acier inoxydable



**P8044** 17 rails trolley for GN pans  
Carro 17 guías GN  
Chariot 17 glissières pour bacs GN



Available also on polyamide castors. Please ask for price.  
Disponible también con ruedas poliamida. Consultar precio.  
Disponible aussi avec roulettes polyamide. Consulter prix.

REF	Entrance / Entrada / Entré cm	
P80440	53	1

**P8048** Disassembled trolley 17 rails for GN pans  
Carro desmontable 17 guías GN  
Chariot démontable 17 glissières pour bacs GN

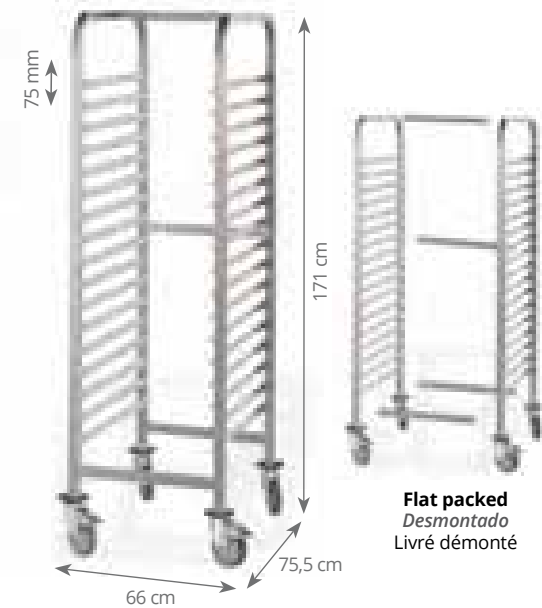

Available also on polyamide castors. Please ask for price.  
Disponible también con ruedas poliamida. Consultar precio.  
Disponible aussi avec roulettes polyamide. Consulter prix.

REF	Entrance / Entrada / Entré cm	
P80480	53	1

**P8051** Stackable trolley 17 rails for GN pans  
Carro encastrable 17 guías GN  
Chariot emboïtable 17 glissières pour bacs GN

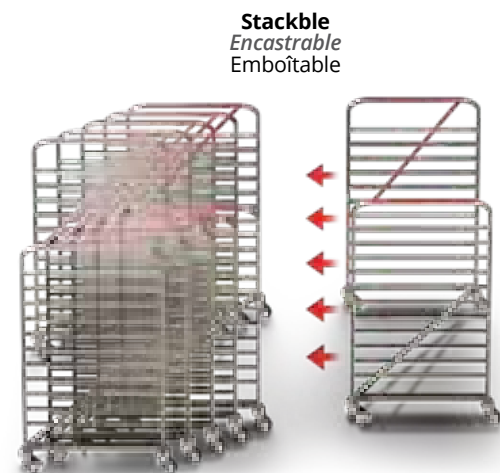

Available also on polyamide castors. Please ask for price.  
Disponible también con ruedas poliamida. Consultar precio.  
Disponible aussi avec roulettes polyamide. Consulter prix.

REF	Entrance / Entrada / Entré cm	
P80510	53	1

# St/steel rail trolleys 10.3

Carros guías en acero inoxidable  
Chariots à glissières en acier inoxydable



**P8084** Pastry trolley  
**P8085** Carro pastelería  
**P8046** Chariot pâtisserie



Entrance 400 mm  
Entrada 400 mm  
Entrée 400 mm

Available also on polyamide castors. Please ask for price.  
Disponible también con ruedas poliamida. Consultar precio.  
Disponible aussi avec roulettes polyamide. Consulter prix.

REF	Nr. of Levels Nº Guías Num. Niveaux	Size of rails Medida guías Dimensions glissières cm	Distance between levels Distancia entre guías Espace entre niveaux cm	
P80840	15	60 x 40	8,5	1
P80850	20	60 x 40	7,0	1
P80460	30	60 x 40	4,5	1

**P8087** Disassembled rail trolley for bakery  
**P8088** Carro desmontable bandejas pastelería  
**P8050** Chariots démontable pour plaques à pâtisserie



Entrance 400 mm  
Entrada 400 mm  
Entrée 400 mm

Available also on polyamide castors. Please ask for price.  
Disponible también con ruedas poliamida. Consultar precio.  
Disponible aussi avec roulettes polyamide. Consulter prix.

REF	Nr. of Levels Nº Guías Num. Niveaux	Size of rails Medida guías Dimensions glissières cm	Distance between levels Distancia entre guías Espace entre niveaux cm	
P80870	15	60 x 40	8,5	1
P80880	20	60 x 40	7,0	1
P80500	30	60 x 40	4,5	1

See products on / Ver productos en / Voir produits en page

P. 154

**GN Pastry Pan**  
Cubeta GN Pastelería  
Bac GN pâtisserie





# 10.3 St/steel rail trolleys

Carros guías en acero inoxidable  
Chariots à glissières en acier inoxydable



**P8081 Defrost trolley 9 rails**  
Carro descongelación 9 guías  
Chariot à dégivrage 9 glissières

**PATENTED EXCLUSIVE**



REF	Mod	W x D x H cm	Entrance Entrada Entré cm	
P80810	GN 2/1	66,5 x 75,5 x 171	53,0	1
P80813	GN 1/1	45,5 x 63,0 x 171	32,5	1

**Space saver while foodstuff defrost.**  
Ahorro de espacio en el proceso de descongelado de los alimentos.  
Economie d'espace pendant le dégivrage des aliments.

**Available also on polyamide castors. Please ask for price.**  
Disponible también con ruedas poliamida. Consultar precio.  
Disponible aussi avec roulettes polyamide. Consulter prix.

**P80811 Special GN container for defrost trolley**  
Cubeta especial GN para carro descongelación  
Bac GN spécial pour chariot dégivrage



Container with drainer hole.  
Cubeta con desagüe.  
Bac avec dégorgeement.

REF	Mod	cm	Lts	H cm	
P80811	GN 2/1	65 x 53	28,9	10	1
P80814	GN 1/1	53 x 32,5	14,2	10	1

**P215 / P115 Perforated bottom**  
Fondo perforado para cubeta  
Egouttoir pour bac



<sup>1</sup> Recommended for item code P80811  
Recomendado para ref. P80811  
Recommandé pour réf. P80811

<sup>2</sup> Recommended for item code P80814  
Recomendado para ref. P80814  
Recommandé pour réf. P80814

REF	Mod	
P215000 <sup>1</sup>	GN 2/1	1
P115000 <sup>2</sup>	GN 1/1	1

# St/steel rail trolleys 10.3

Carros guías en acero inoxidable  
Chariots à glissières en acier inoxydable



**P8095 Self-service trolley 12 rails**  
Carro self-service 12 guías  
Chariot self-service 12 glissières

**P8096 Self-service trolley 24 rails**  
Carro self-service 24 guías  
Chariot self-service 24 glissières



**New 12 cm width rails**  
Nuevas guías de 12 cm de ancho  
Nouveaux rails de 12 cm de large

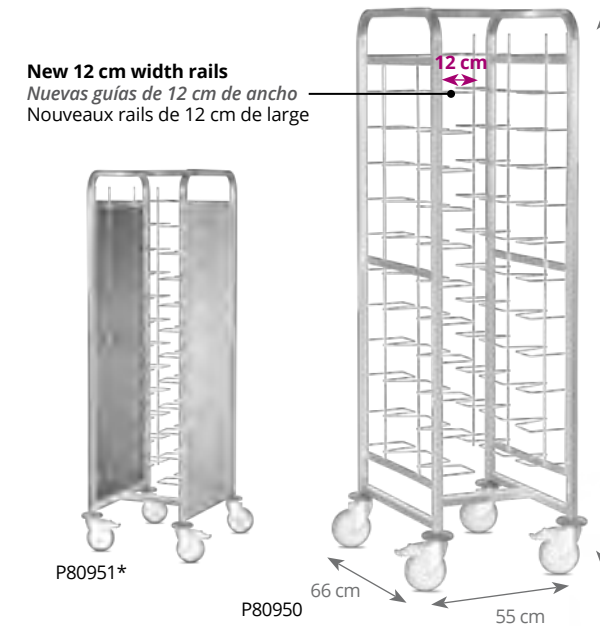

\* With two side panels made of aluminium+composite.  
\* Con dos paneles laterales composite+aluminio.  
\* Avec deux panneaux latéraux en composite+aluminium.

REF	
P80950	1
P80951*	1

\* With two side panels made of aluminium+composite.  
\* Con dos paneles laterales composite+aluminio.  
\* Avec deux panneaux latéraux en composite+aluminium.



REF	
P80965	1
P80966*	1

\* With two side panels made of aluminium+composite.  
\* Con dos paneles laterales composite+aluminio.  
\* Avec deux panneaux latéraux en composite+aluminium.

See products on / Ver productos en / Voir produits en page

P. 222

**Polypropylene fast food trays**  
Bandejas de polipropileno para comida rápida  
Plateaux de restauration rapide en polypropylène



## 10.3 St/steel rail trolleys

Carros guías en acero inoxidable  
Chariots à glissières en acier inoxydable



**P8091 Double fast-food tray trolley 12 rails**  
Carro doble para bandejas fast-food 12 guías  
Chariot double pour plateaux fast-food 12 glissières



Suitable for trays 480 x 370 mm  
Ideal para bandejas 480 x 370 mm  
Ideal pour plateaux 480 x 370 mm

Entrance 480 mm  
Entrada 480 mm  
Entrée 480 mm

Available also on polyamide castors. Please ask for price.  
Disponibile también con ruedas poliamida. Consultar precio.  
Disponible aussi avec roulettes polyamide. Consulter prix.

REF	Size of rails Medida guías Dimensions glissières cm	
P80910	48 x 80	1

**P925 Transport trolley for isothermal trays**  
Carro transporte bandejas isotérmicas  
Chariot transport plateaux isothermes



Trolley made of St/Steel and plastic rails. Perfect for many different size trays transport thanks to the special rail design. Soundproof revolving castors Ø 125 mm.

Carro fabricado en acero inoxidable y guías de plástico. Ideal para el transporte de bandejas de distintas medidas, gracias al diseño especial de sus guías. Ruedas giratorias insonoras de Ø 125 mm.

Chariot fabriqué en acier inoxydable et glissières en plastique. Idéal pour le transport des plateaux de différentes mesures, grâce au design spécial des glissières. Roulettes insonores de Ø 125 mm.

REF	Nr. of Levels Nº Guías Num. Niveaux	Size of rails Medida guías Dimensions glissières cm	W x D x H cm	
P925001	10	55 x 37,5	50 x 62 x 152	1
P925002	20	55 x 37,5	92 x 62 x 152	1

See products on / Ver productos en / Voir produits en page

P. 220

**Isothermal tray**  
Bandeja isotérmica  
Plateau Isotherme



## Special trolleys 10.4

Carros especiales  
Chariots spéciaux



**P80790 Plate trolley**  
Carro para platos  
Chariot à vaisselle



REF	W x D x H cm	
P80790	58 x 71 x 177,5	1

The distance between levels is 5,8 cm  
Distancia entre niveles 5,8 cm.  
Distance entre les niveaux 5,8 cm.

Carbon steel with anti-corrosion coating  
Acero al carbono con recubrimiento anticorrosivo  
Acier au carbone avec revêtement anti-corrosion

Capacity for 100 dishes. Different sizes of dishes can be combined thanks to its adjustable system.

Capacidad para 100 platos. Se pueden combinar diferentes tamaños de platos gracias a su sistema ajustable.

Capacité pour 100 assiettes. Différentes tailles de plats peuvent être combinées grâce à son système réglable.

(Ø máx. 34,5cm)

Strong welded structure handle for easy transport

Resistente estructura soldada con asa para fácil transporte.  
Structure soudée robuste avec poignée pour un transport facile.

4 Wheels of 125mm with bumpers. 2 wheels brakes included.

4 ruedas de 12,5 cm con parachoques. 2 ruedas con freno.  
4 roues de 125 mm avec pare-chocs. 2 roulettes avec freins

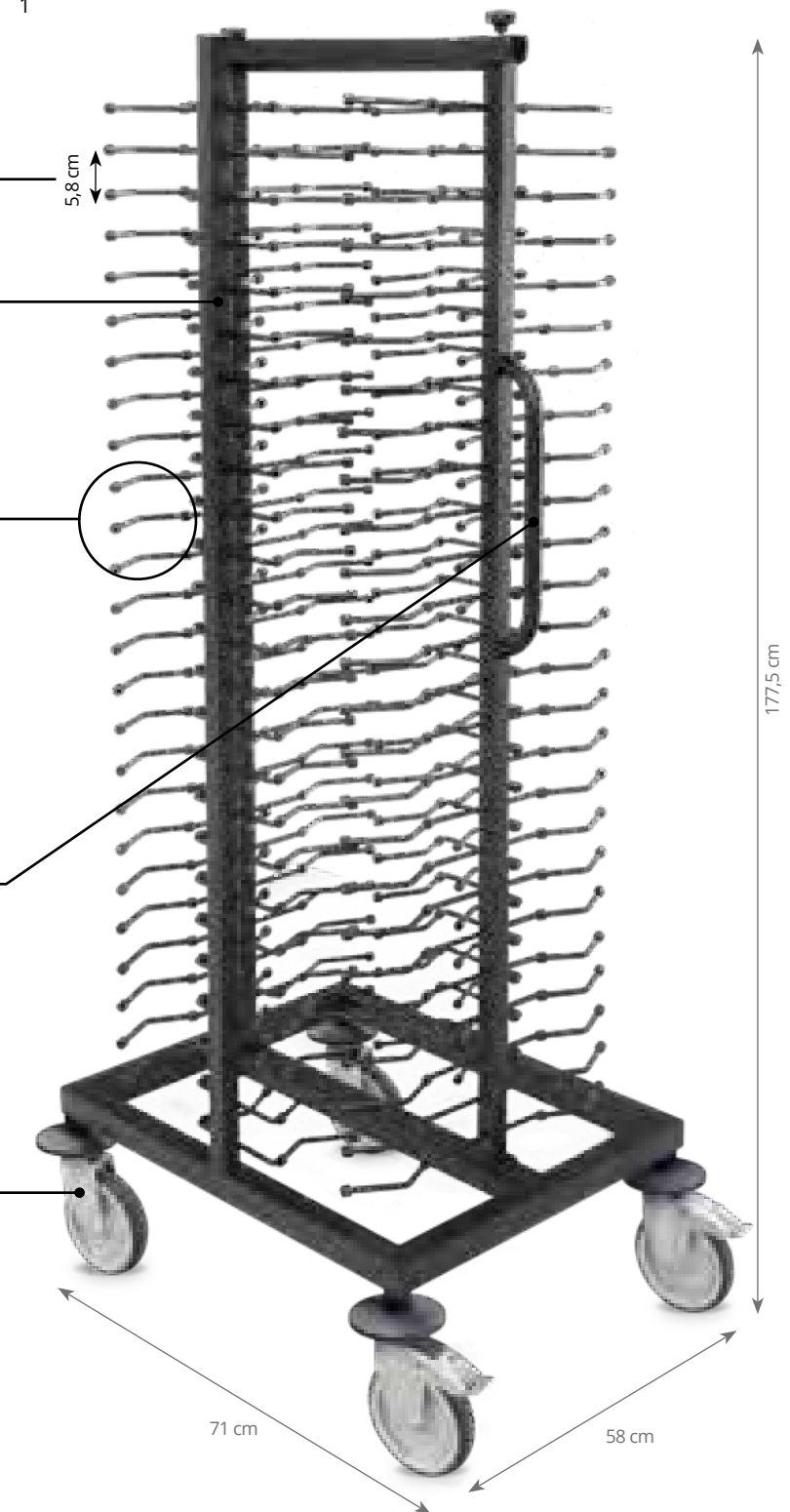

# 10.4 Special trolleys

Carros especiales  
Chariots spéciaux



**P8039 GN containers transport trolley**  
Carro porta cubetas GN  
Chariot transport bacs GN



**GN containers not included.**  
No incluye cubetas GN.  
Bacs GN non inclus.

**Available also on polyamide castors. Please ask for price.**  
Disponible también con ruedas poliamida. Consultar precio.  
Disponible aussi avec roulettes polyamide. Consulter prix.

REF	1
P80390	1

**P8038 2/1 GN transport trolley**  
Carro porta cubeta GN 2/1  
Chariot transport bac GN 2/1



**GN containers not included.**  
No incluye cubetas GN.  
Bacs GN non inclus.

**Available also on polyamide castors. Please ask for price.**  
Disponible también con ruedas poliamida. Consultar precio.  
Disponible aussi avec roulettes polyamide. Consulter prix.

REF. P80.390 / P80.380  
**Transport trolley for GN containers**  
Carro transporte para cubetas GN  
Chariots de transport pour bacs GN

**Made of St/Steel. Perfect for storing and transporting large quantities of prepared food and sauces.**

Fabricados en acero inoxidable. Ideales para el almacenaje y transporte de alimentos preparados y salsas en grandes cantidades.  
Fabriqués en acier inoxydable. Idéales pour le stockage et le transport d'aliments cuisinés et sauces en grandes quantités.

REF	1
P80380	1

**P8054 Tray transport trolley 7 rails**  
Carro transporte bandejas 7 guías  
Chariot transport plateaux 7 glissières



Ref. P80.540

Ref. P80.780

**Available also on polyamide castors. Please ask for price.**  
Disponible también con ruedas poliamida. Consultar precio.  
Disponible aussi avec roulettes polyamide. Consulter prix.

REF	Size of rails Medida guías Dimensions glissières cm	W x D x H cm	Distance between levels Distancia entre guías Espace entre niveaux cm	1
P80540	GN 1/1	45,5 x 63,5 x 90	7,5	1
P80550	GN 2/1	66 x 75 x 90	7,5	1
P80560	Pastry / Pastelería Pâtisserie (60 x 40 cm)	52,5 x 70 x 90	8,5	1
P80780	GN 1/1 Doble	81 x 63,5 x 90	7,5	1

**P8074 Trolley cutlery dispenser GN 1/3**  
Carro portacubiertos GN 1/3 y porta bandejas  
Chariot porte-ramasse couverts GN 1/3



**GN containers not included.**  
No incluye cubetas GN.  
Bacs GN non inclus.

**Available also on polyamide castors. Please ask for price.**  
Disponible también con ruedas poliamida. Consultar precio.  
Disponible aussi avec roulettes polyamide. Consulter prix.

REF	1
P80740	1



# Special trolleys 10.4

Carros especiales  
Chariots spéciaux

**P8075 Dishwasher rack trolley**  
**P8076 Carro para cestas Vajillas**  
**P8077 Chariot casiers à vaisselle**



REF	Nr. of Levels Nº Guías Num. Niveaux	Size of rails Medida guías Dimensions glissières cm	W x D x H cm	1
P80750	5	50 x 50	64 x 63,3 x 116	1
P80760	9	50 x 50	64 x 63,3 x 171	1
P80770	9	50 x 50 (double / doble)	118,5 x 63,3 x 171	1

**P8057 Trolley for heavy loads**  
Carro para cargas pesadas  
Chariot à charges lourdes

**Maximum load: 350 kg**  
Carga máxima: 350 kg  
Charge maximale: 350 kg



REF	1
P80570	1

**P8058 St/steel trolley for dishwasher racks**  
**P8059 Carro inox para cestas**  
Chariot inox pour casiers à vaisselle



REF	H cm	without handle / sin asa / sans anse	1
P80590	16,5	without handle / sin asa / sans anse	1
P80580	106,5	with handle / con asa / avec anse	1

# 10.4 Special trolleys

Carros especiales  
Chariots spéciaux



**P5015** Plastic trolley for dishwasher racks  
Carro de plástico para cestas  
Chariot pour casiers à vaisselle

Without handle  
Sin asa  
Sans anse

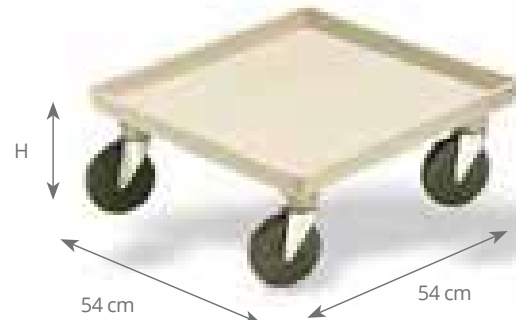

REF	H cm	
P5015	23	1

**P5017** Plastic trolley with handle for dishwasher racks  
Carro de plástico con asa para cestas  
Chariot avec anse pour casiers à vaisselle

With handle  
Con asa  
Avec anse



REF	H cm	
P5017	98	1

**1697** Plastic trolley for dishwasher racks  
Carro de plástico para cestas  
Chariot pour casiers à vaisselle

Without handle  
Sin asa  
Sans anse



REF	Ø cm	H cm	
1697	1,4	8,7	1

**52291** Dishwasher rack insert or cover  
Tapa o inserto para cestas  
Couvercle or inserto pour casiers à vaisselle



REF		
52291		1

# Special trolleys 10.4

Carros especiales  
Chariots spéciaux



**ADC-4** Adjustable dish caddy  
Carro ajustable para platos  
Chariot modulable pour assiettes



Delivered with 4 posts plus 1 protection cover.  
Se sirve con 4 columnas separadoras más una funda protectora.  
Livré avec 4 colonnes de séparation et 1 housse de protection.

Unique and easy adjustment from the top.  
Ajuste único y fácil por la parte superior.  
Reglage unique et facile de la partie supérieure.

COMBINATIONS  
COMBINACIONES  
COMBINATIONS  
Size plates  
Tamaño platos  
Taille assiettes

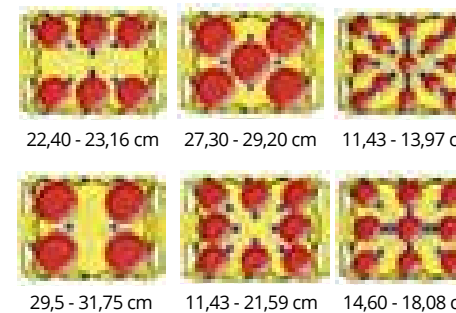

REF		
ADC-4		1

**ADP** Post for dish trolley  
Columna separadora carro platos  
Colonne séparation chariot assiettes



Compatible ref. ADC-4  
Compatible ref. SAC-SQ5-06

REF		
ADP		1

**SAC-SQ5-06** Adjustable caddy for square & round dishes  
Carro ajustable para platos cuadrados y redondos  
Chariot modulable pour assiettes carrées et rondes



Unique, stackable design.  
Diseño exclusivo apilable.  
Design exclusif empilable.

Delivered with 5 posts, one of them in cross shape plus 1 protection cover.  
Se sirve con 5 columnas separadoras una de ellas en forma de cruz más una funda protectora.

Livré avec 5 colonnes de séparation une desquelles en forme de croix plus 1 housse de protection.

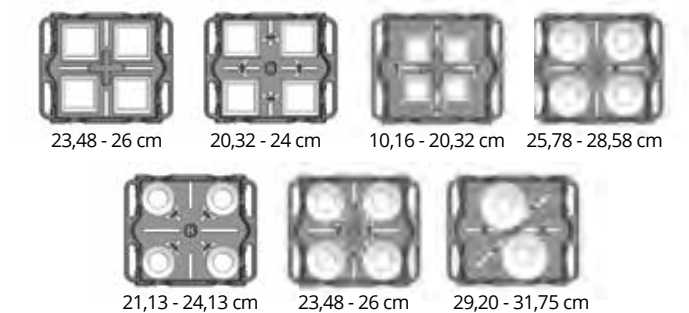

REF		
SAC-SQ5-06		1

**SAVC** Vinyl cover for dish trolley  
Funda protectora de vinilo para carro platos  
Housse protection en vinyle pour chariot assiettes



Cover for item SAVC. Funda para ref. ADC-4  
Housse pour réf. SAC-SQ5-06

REF		
SAVC		1

# 11 Shelving

Estanterías  
Rayonnages



## 11.1 COMPLETE AND ANGULAR SHELVING 267

ESTANTERÍAS COMPLETAS Y ANGULARES  
RAYONNAGES COMPLETS ET ANGULAIRES

## 11.2 SHELVING WITH WHEELS 274

ESTANTERÍAS CON RUEDAS  
RAYONNAGES AVEC ROUES

## 11.3 BENCH 274

BANCADAS  
BANCS

## 11.4 PARTS 275

COMPONENTES  
COMPOSANTS

## 11.5 BREAKDOWN OF SHELVING SETS 278

DESGLOSE CONJUNTOS DE ESTANTERÍAS  
DÉCOMPOSITION KITS RAYONNAGES

# Modular shelving

Estanterías modulares  
Rayonnages modulables



-30 °C  
+75 °C

Easy and quick assembly  
Facilidad y rapidez de montaje  
Montage facile et rapide



**ANTICORROSIVE - Manufactured with special anodised aluminium**

ANTICORROSIÓN - Fabricadas con estructura de aluminio anodizado

ANTI-CORROSION - Fabriqué avec une structure fabriquée en aluminium anodisé

**Robustness and resistance**

Robustez y resistencia  
Robustesse et résistance

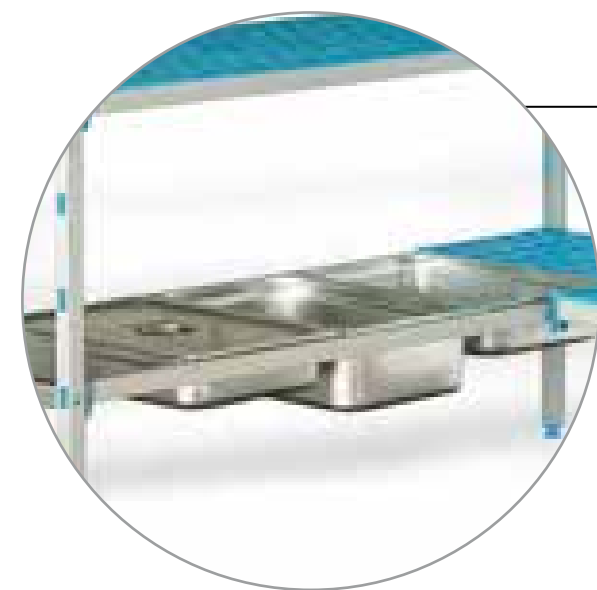

**Compatibility**  
Compatible  
Compatibilité  
GN 1/1 & 2/3



**Rack shelves**

Parrillas  
Clayettes

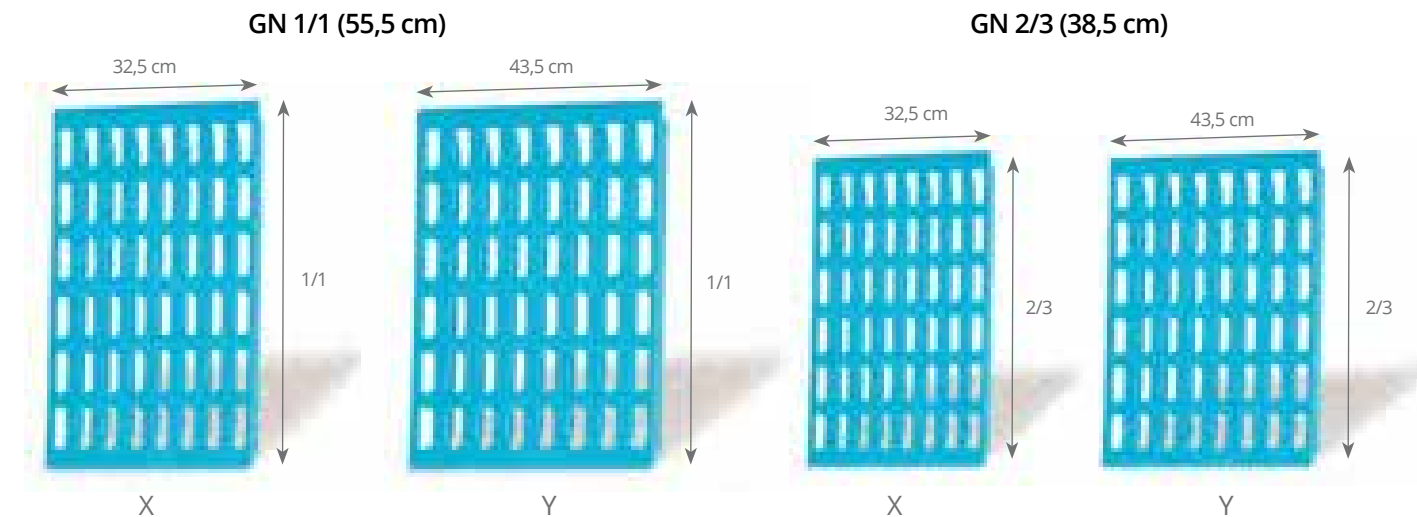

**Dishwasher safe**  
Apto para lavavajillas  
Apte pour lave-vaisselle

**Combining rack shelves among the same group (X/Y) allows to personalize the lengths of each shelf. (Refer to next page for proposed combinations)**

Combinando parrillas de la misma profundidad (X/Y) permite personalizar las longitudes de las estanterías a cada una de las necesidades. (Ver en página siguiente combinaciones propuestas)

En combinant des clayettes de la même profondeur (X/Y) permet de personnaliser les longueurs des rayonnages à tout besoin. (Voir page suivante pour des combinaisons proposées)

**Support for crossbars**

Pieza soporte travesaños  
Support pour longerons

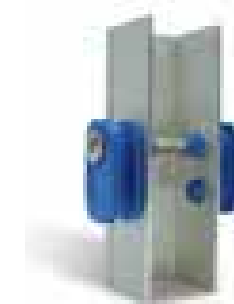

**Special fixing system support for crossbars which offers the highest security, reliability and robustness.**

Sistema especial de fijación de soporte para travesaños que ofrece la máxima seguridad, fiabilidad y robustez.

Système spécial de fixation des supports pour longerons qui offre la sécurité, fiabilité et robustesse maximale.

**Adjustable feet**

Pies regulables  
Pieds réglables

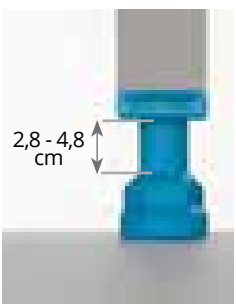

**Levelling feet with hidden thread, for gradient floors. It is also possible to adapt Ø 12,5 cm wheels.**

Pies regulables con rosca oculta para suelos con desniveles. Con la posibilidad de adaptar ruedas de Ø 12,5 cm.

Pieds réglables avec filetage caché pour sols irréguliers. Il est aussi possible d'y adapter des roues de Ø 12,5 cm.



# Modular shelving

Estanterías modulares  
Rayonnages modulables

## Standard heights of levels

Alturas estándar de los niveles  
Hauteur standard des niveaux

Higher than 200 cm please ask

Más de 200 cm altura consultar

Hauteur supérieure à 200 cm veuillez nous consulter

### Height 175 cm / 3 levels

Altura 175 cm / 3 niveles  
Hauteur 175 cm / 3 niveaux

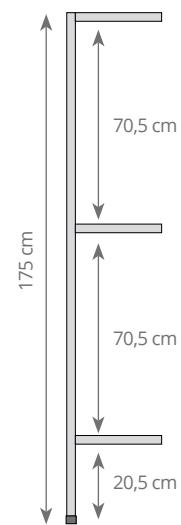

### Height 175 cm / 4 levels

Altura 175 cm / 4 niveles  
Hauteur 175 cm / 4 niveaux

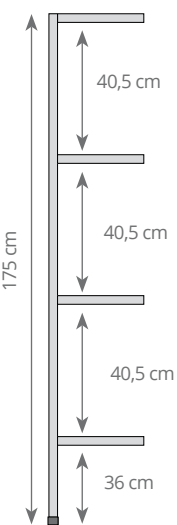

### Height 175 cm / 5 levels

Altura 175 cm / 5 niveles  
Hauteur 175 cm / 5 niveaux

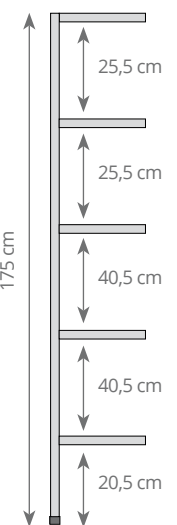

### Height 205 cm / 4 levels

Altura 205 cm / 4 niveles  
Hauteur 205 cm / 4 niveaux

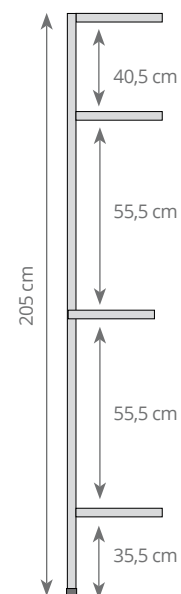

### Height 205 cm / 5 levels

Altura 205 cm / 5 niveles  
Hauteur 205 cm / 5 niveaux

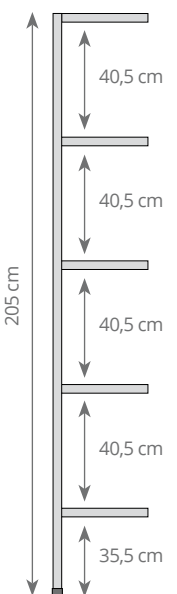

### Height 205 cm / 6 levels

Altura 205 cm / 6 niveles  
Hauteur 205 cm / 6 niveaux

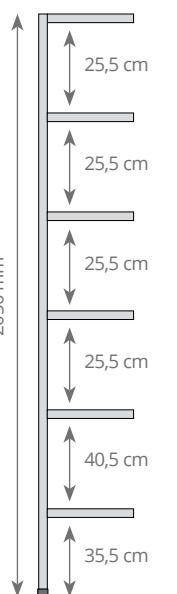

### Height 130 cm / 3 levels

Altura 130 cm / 3 niveles  
Hauteur 130 cm / 3 niveaux

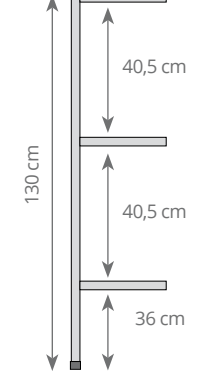

### Combinations

Combinaciones  
Combinaisons

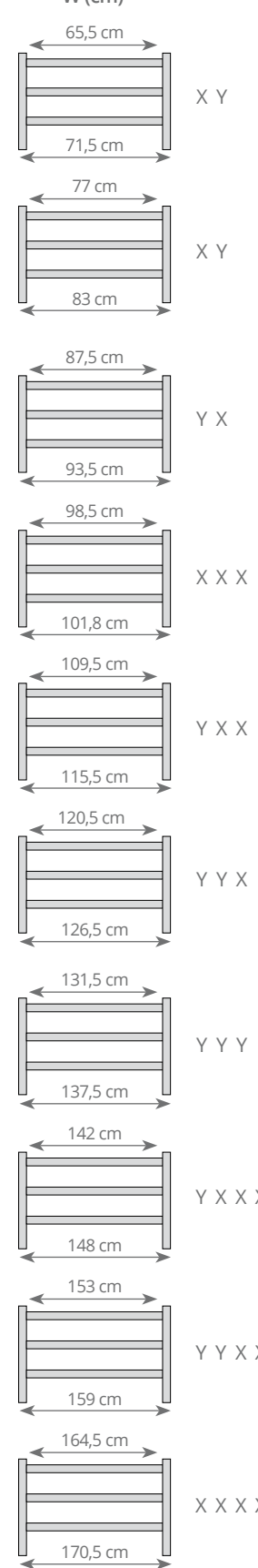

# Complete and angular shelving

Estanterías completas y angulares  
Rayonnages complets et angulaires



# 11.1 Full shelf

Estantería completa  
Rayonnage complet

**3 Levels**  
Niveles  
Niveaux

**Complete kits**  
Kits completos  
Kits complets

**Diferent combinations**  
Distintas combinaciones  
Diferentes combinaisons



**Compatible with 2/3 containers**  
Compatible con cubetas 2/3  
Compatible avec bacs 2/3

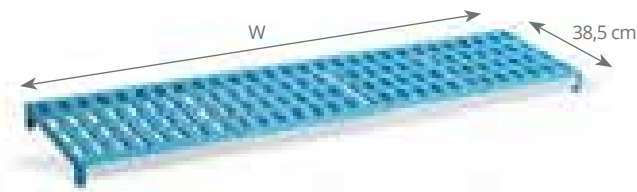

**Compatible with 1/1 containers**  
Compatible con cubetas 1/1  
Compatible avec bacs 1/1

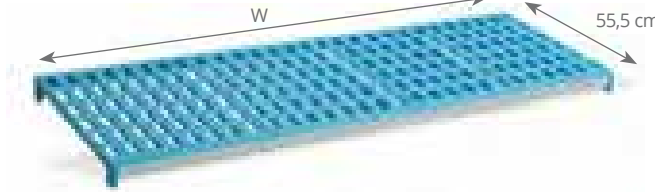

REF	W cm	REF	W cm
P7000	71,5	P7024	338,0
P7001	83,0	P7025	351,3
P7002	93,5	P7026	362,1
P7003	104,5	P7027	372,9
P7004	115,5	P7028	384,1
P7005	126,5	P7029	395,3
P7006	137,5	P7030	406,5
P7007	148,0	P7031	417,0
P7008	159,0	P7032	427,5
P7009	170,5	P7033	438,0
P7010	184,0	P7034	449,0
P7011	195,0	P7035	460,0
P7012	206,0	P7036	471,0
P7013	217,0	P7037	482,5
P7014	228,0	P7038	494,0
P7015	238,8	P7039	505,5
P7016	249,6	P7040	518,6
P7017	260,8	P7041	529,8
P7018	272,0	P7042	541,0
P7019	282,5	P7043	551,5
P7020	293,0	P7044	562,0
P7021	304,0	P7045	572,5
P7022	315,0	P7046	583,0
P7023	326,5		

REF	W cm	REF	W cm
P7141	71,5	P7165	338,0
P7142	83,0	P7166	351,3
P7143	93,5	P7167	362,1
P7144	104,5	P7168	372,9
P7145	115,5	P7169	384,1
P7146	126,3	P7170	395,3
P7147	137,5	P7171	406,5
P7148	148,0	P7172	417,0
P7149	159,0	P7173	427,5
P7150	170,5	P7174	438,0
P7151	184,0	P7175	449,0
P7152	195,0	P7176	460,0
P7153	206,0	P7177	471,0
P7154	217,0	P7178	482,5
P7155	228,0	P7179	494,0
P7156	238,8	P7180	505,5
P7157	249,6	P7181	518,6
P7158	260,8	P7182	529,8
P7159	272,0	P7183	541,0
P7160	282,5	P7184	551,5
P7161	293,0	P7185	562,0
P7162	304,0	P7186	572,5
P7163	315,0	P7187	583,0
P7164	326,5		

**IDEA!** \* For others heights, see the table (p. 278 - 281)  
\* Para otras alturas, consultar el desglose (p. 278 - 281)  
\* Pour autres hauteurs, consulter le tableau de décomposition (p. 278 - 281)

# Shelving for angle 11.1

Estantería angular  
Rayonnage angulaire

**3 Levels**  
Niveles  
Niveaux

**Shelving for angle**  
Estanterías angulares  
Rayonnages angulaires

**Diferent combinations**  
Distintas combinaciones  
Diferentes combinaisons



**Included / Includo / Compris :**  
**Hooks to form angles**  
Ganchos para formar ángulos  
Crochets pour faire les angles

**Compatible with 2/3 containers**  
Compatible con cubetas 2/3  
Compatible avec bacs 2/3

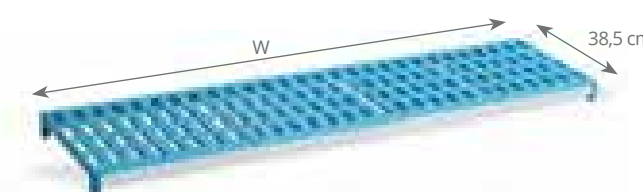

REF	W cm	REF	W cm
P7282	68,5	P7306	335,0
P7283	80,0	P7307	348,3
P7284	90,5	P7308	359,1
P7285	101,5	P7309	369,9
P7286	112,5	P7310	381,1
P7287	123,3	P7311	392,3
P7288	134,5	P7312	403,5
P7289	145,0	P7313	414,0
P7290	156,0	P7314	424,5
P7291	167,5	P7315	435,0
P7292	181,0	P7316	446,0
P7293	192,0	P7317	457,0
P7294	203,0	P7318	468,0
P7295	214,0	P7319	479,5
P7296	225,0	P7320	491,0
P7297	235,8	P7321	502,5
P7298	246,6	P7322	515,6
P7299	257,8	P7323	526,8
P7300	269,0	P7324	538,0
P7301	279,5	P7325	548,5
P7302	290,0	P7326	559,0
P7303	301,0	P7327	569,5
P7304	312,0	P7328	580,0
P7305	323,5		

**IDEA!** \* For others heights, see the table (p. 278 - 281)  
\* Para otras alturas, consultar el desglose (p. 278 - 281)  
\* Pour autres hauteurs, consulter le tableau de décomposition (p. 278 - 281)



# 11.1 Full shelf

Estantería completa  
Rayonnage complet

**4 Levels**  
Niveles  
Niveaux

**Complete kits**  
Kits completos  
Kits complets

**Diferent combinations**  
Distintas combinaciones  
Differentes combinaisons



Compatible with 2/3 containers  
Compatible con cubetas 2/3  
Compatible avec bacs 2/3

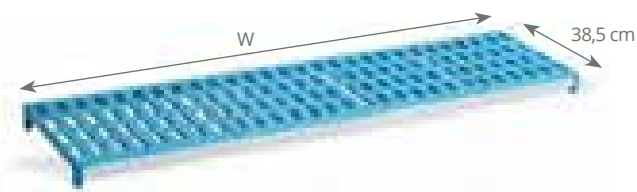

Compatible with 1/1 containers  
Compatible con cubetas 1/1  
Compatible avec bacs 1/1

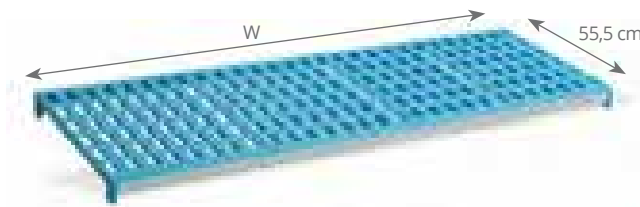

REF	W cm	REF	W cm
P7047	71,5	P7071	338,0
P7048	83,0	P7072	351,3
P7049	93,5	P7073	362,1
P7050	104,5	P7074	372,9
P7051	115,5	P7075	384,1
P7052	126,3	P7076	395,3
P7053	137,5	P7077	406,5
P7054	148,0	P7078	417,0
P7055	159,0	P7079	427,5
P7056	170,5	P7080	438,0
P7057	184,0	P7081	449,0
P7058	195,0	P7082	460,0
P7059	206,0	P7083	471,0
P7060	217,0	P7084	482,5
P7061	228,0	P7085	494,0
P7062	238,8	P7086	505,5
P7063	249,6	P7087	518,6
P7064	260,8	P7088	529,8
P7065	272,0	P7089	541,0
P7066	282,5	P7090	551,5
P7067	293,0	P7091	562,0
P7068	304,0	P7092	572,5
P7069	315,0	P7093	583,0
P7070	326,5		

REF	W cm	REF	W cm
P7188	71,5	P7212	338,0
P7189	83,0	P7213	351,3
P7190	93,5	P7214	362,1
P7191	104,5	P7215	372,9
P7192	115,5	P7216	384,1
P7193	126,3	P7217	395,3
P7194	137,5	P7218	406,5
P7195	148,0	P7219	417,0
P7196	159,0	P7220	427,5
P7197	170,5	P7221	438,0
P7198	184,0	P7222	449,0
P7199	195,0	P7223	460,0
P7200	206,0	P7224	471,0
P7201	217,0	P7225	482,5
P7202	228,0	P7226	494,0
P7203	238,8	P7227	505,5
P7204	249,6	P7228	518,6
P7205	260,8	P7229	529,8
P7206	272,0	P7230	541,0
P7207	282,5	P7231	551,5
P7208	293,0	P7232	562,0
P7209	304,0	P7233	572,5
P7210	315,0	P7234	583,0
P7211	326,5		

**IDEA!** \* For others heights, see the table (p. 278 - 281)  
\* Para otras alturas, consultar el desglose (p. 278 - 281)  
\* Pour autres hauteurs, consulter le tableau de décomposition (p. 278 - 281)

# Shelving for angle 11.1

Estantería angular  
Rayonnage angulaire

**4 Levels**  
Niveles  
Niveaux

**Shelvings for angle**  
Estanterías angulares  
Rayonnages angulaires

**Diferent combinations**  
Distintas combinaciones  
Differentes combinaisons



**Included / Includo / Compris :**  
**Hooks to form angles**  
Ganchos para formar ángulos  
Crochets pour faire les angles

Compatible with 2/3 containers  
Compatible con cubetas 2/3  
Compatible avec bacs 2/3

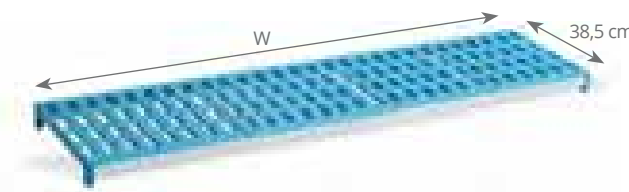

Compatible with 1/1 containers  
Compatible con cubetas 1/1  
Compatible avec bacs 1/1

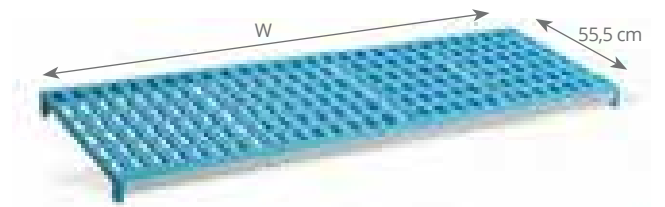

REF	W cm	REF	W cm
P7329	68,5	P7353	335,0
P7330	80,0	P7354	348,3
P7331	90,5	P7355	359,1
P7332	101,5	P7356	369,9
P7333	112,5	P7357	381,1
P7334	123,3	P7358	392,3
P7335	134,5	P7359	403,5
P7336	145,0	P7360	414,0
P7337	156,0	P7361	424,5
P7338	167,5	P7362	435,0
P7339	181,0	P7363	446,0
P7340	192,0	P7364	457,0
P7341	203,0	P7365	468,0
P7342	214,0	P7366	479,5
P7343	225,0	P7367	491,0
P7344	235,8	P7368	502,5
P7345	246,6	P7369	515,6
P7346	257,8	P7370	526,8
P7347	269,0	P7371	538,0
P7348	279,5	P7372	548,5
P7349	290,0	P7373	559,0
P7350	301,0	P7374	569,5
P7351	312,0	P7375	580,0
P7352	323,5		

REF	W cm	REF	W cm
P7470	68,5	P7494	335,0
P7471	80,0	P7495	348,3
P7472	90,5	P7496	359,1
P7473	101,5	P7497	369,9
P7474	112,5	P7498	381,1
P7475	123,3	P7499	392,3
P7476	134,5	P7500	403,5
P7477	145,0	P7501	414,0
P7478	156,0	P7502	424,5
P7479	167,5	P7503	435,0
P7480	181,0	P7504	446,0
P7481	192,0	P7505	457,0
P7482	203,0	P7506	468,0
P7483	214,0	P7507	479,5
P7484	225,0	P7508	491,0
P7485	235,8	P7509	502,5
P7486	246,6	P7510	515,6
P7487	257,8	P7511	526,8
P7488	269,0	P7512	538,0
P7489	279,5	P7513	548,5
P7490	290,0	P7514	559,0
P7491	301,0	P7515	569,5
P7492	312,0	P7516	580,0
P7493	323,5		

**IDEA!** \* For others heights, see the table (p. 278 - 281)  
\* Para otras alturas, consultar el desglose (p. 278 - 281)  
\* Pour autres hauteurs, consulter le tableau de décomposition (p. 278 - 281)

# 11.1 Full shelf

Estantería completa  
Rayonnage complet

**5 Levels**  
Niveles  
Niveaux

**Complete kits**  
Kits completos  
Kits complets

**Diferent combinations**  
Distintas combinaciones  
Differentes combinaisons



**Compatible with 2/3 containers**  
Compatible con cubetas 2/3  
Compatible avec bacs 2/3

**Compatible with 1/1 containers**  
Compatible con cubetas 1/1  
Compatible avec bacs 1/1

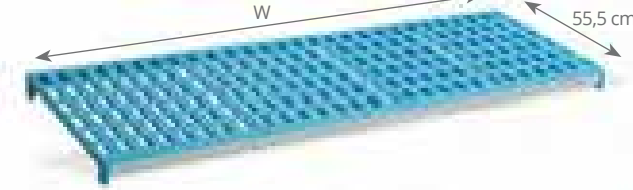
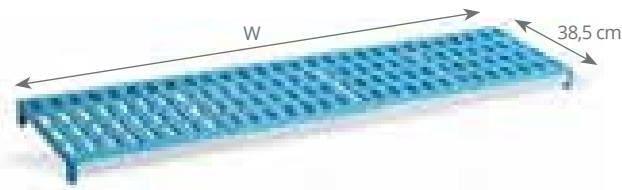

REF	W cm	REF	W cm
P7094	71,5	P7118	338,0
P7095	83,0	P7119	351,3
P7096	93,5	P7120	362,1
P7097	104,5	P7121	372,9
P7098	115,5	P7122	384,1
P7099	126,3	P7123	395,3
P7100	137,5	P7124	406,5
P7101	148,0	P7125	417,0
P7102	159,0	P7126	427,5
P7103	170,5	P7127	438,0
P7104	184,0	P7128	449,0
P7105	195,0	P7129	460,0
P7106	206,0	P7130	471,0
P7107	217,0	P7131	482,5
P7108	228,0	P7132	494,0
P7109	238,8	P7133	505,5
P7110	249,6	P7134	518,6
P7111	260,8	P7135	529,8
P7112	272,0	P7136	541,0
P7113	282,5	P7137	551,5
P7114	293,0	P7138	562,0
P7115	304,0	P7139	572,5
P7116	315,0	P7140	583,0
P7117	326,5		

REF	W cm	REF	W cm
P7235	71,5	P7259	338,0
P7236	83,0	P7260	351,3
P7237	93,5	P7261	362,1
P7238	104,5	P7262	372,9
P7239	115,5	P7263	384,1
P7240	126,3	P7264	395,3
P7241	137,5	P7265	406,5
P7242	148,0	P7266	417,0
P7243	159,0	P7267	427,5
P7244	170,5	P7268	438,0
P7245	184,0	P7269	449,0
P7246	195,0	P7270	460,0
P7247	206,0	P7271	471,0
P7248	217,0	P7272	482,5
P7249	228,0	P7273	494,0
P7250	238,8	P7274	505,5
P7251	249,6	P7275	518,6
P7252	260,8	P7276	529,8
P7253	272,0	P7277	541,0
P7254	282,5	P7278	551,5
P7255	293,0	P7279	562,0
P7256	304,0	P7280	572,5
P7257	315,0	P7281	583,0
P7258	326,5		

**IDEA!** \* For others heights, see the table (p. 278 - 281)  
\* Para otras alturas, consultar el desglose (p. 278 - 281)  
\* Pour autres hauteurs, consulter le tableau de décomposition (p. 278 - 281)

# Shelving for angle 11.1

Estantería angular  
Rayonnage angulaire

**5 Levels**  
Niveles  
Niveaux

**Shelvings for angle**  
Estanterías angulares  
Rayonnages angulaires

**Diferent combinations**  
Distintas combinaciones  
Differentes combinaisons

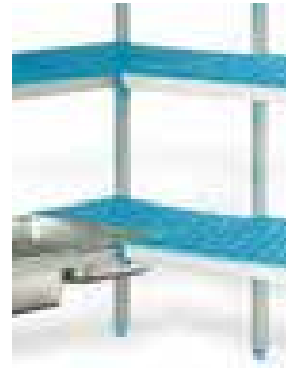

**Included / Includo / Compris :**  
**Hooks to form angles**  
Ganchos para formar ángulos  
Crochets pour faire les angles



**Compatible with 2/3 containers**  
Compatible con cubetas 2/3  
Compatible avec bacs 2/3

**Compatible with 1/1 containers**  
Compatible con cubetas 1/1  
Compatible avec bacs 1/1

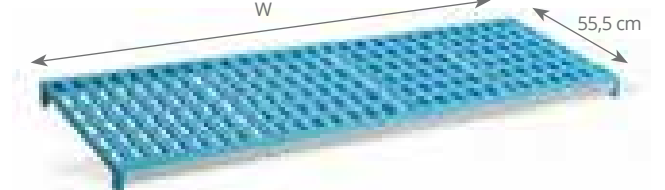
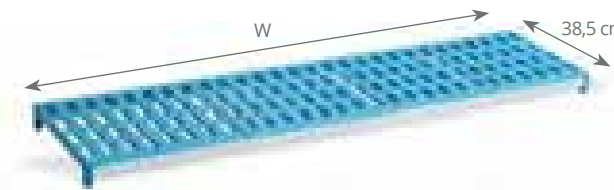

REF	W cm	REF	W cm
P7376	68,5	P7400	335,0
P7377	80,0	P7401	348,3
P7378	90,5	P7402	359,1
P7379	101,5	P7403	369,9
P7380	112,5	P7404	381,1
P7381	123,3	P7405	392,3
P7382	134,5	P7406	403,5
P7383	145,0	P7407	414,0
P7384	156,0	P7408	424,5
P7385	167,5	P7409	435,0
P7386	181,0	P7410	446,0
P7387	192,0	P7411	457,0
P7388	203,0	P7412	468,0
P7389	214,0	P7413	479,5
P7390	225,0	P7414	491,0
P7391	235,8	P7415	502,5
P7392	246,6	P7416	515,6
P7393	257,8	P7417	526,8
P7394	269,0	P7418	538,0
P7395	279,5	P7419	548,5
P7396	290,0	P7420	559,0
P7397	301,0	P7421	569,5
P7398	312,0	P7422	580,0
P7399	323,5		

REF	W cm	REF	W cm
P7517	68,5	P7541	335,0
P7518	80,0	P7542	348,3
P7519	90,5	P7543	359,1
P7520	101,5	P7544	369,9
P7521	112,5	P7545	381,1
P7522	123,3	P7546	392,3
P7523	134,5	P7547	403,5
P7524	145,0	P7548	414,0
P7525	156,0	P7549	424,5
P7526	167,5	P7550	435,0
P7527	181,0	P7551	446,0
P7528	192,0	P7552	457,0
P7529	203,0	P7553	468,0
P7530	214,0	P7554	479,5
P7531	225,0	P7555	491,0
P7532	235,8	P7556	502,5
P7533	246,6	P7557	515,6
P7534	257,8	P7558	526,8
P7535	269,0	P7559	538,0
P7536	279,5	P7560	548,5
P7537	290,0	P7561	559,0
P7538	301,0	P7562	569,5
P7539	312,0	P7563	580,0
P7540	323,5		

**IDEA!** \* For others heights, see the table (p. 278 - 281)  
\* Para otras alturas, consultar el desglose (p. 278 - 281)  
\* Pour autres hauteurs, consulter le tableau de décomposition (p. 278 - 281)

## 11.2 Shelving with castors

Estanterías con ruedas  
Rayonnages avec roues

### Complete kits with wheels

Conjuntos completos con ruedas  
Kits complets avec roues

 **Maximum weight per level 150 kg**  
**Maximum weight per shelving unit 400 kg**

Peso máximo por nivel 150 kg  
Peso máximo por estantería 400 kg  
Poids maximum par niveau 150 kg  
Poids maximum par rayonnage 400 kg



REF	W x D x H cm	Type / tipo	Levels Niveles Niveaux	
P7145R	114,5 x 55,5 x 188	GN 1/1	3	1
P7004R	114,5 x 38,5 x 188	GN 2/3	3	1
P7146R	126,5 x 55,5 x 188	GN 1/1	3	1
P7005R	126,5 x 38,5 x 188	GN 2/3	3	1
P7147R	137,5 x 55,5 x 188	GN 1/1	3	1
P7006R	137,5 x 38,5 x 188	GN 2/3	3	1

## 11.3 Bench

Bancadas  
Bancs

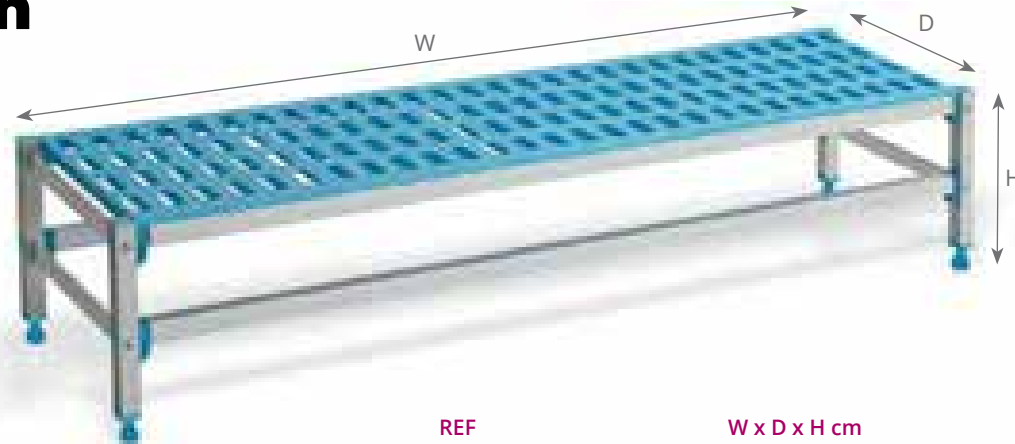

Designed to be used in places where it is forbidden to put boxes directly on the floor. Maximum load charge 175 Kg per bench, distributed weight throughout the bench. Leveling feet for gradient floors.

Diseñadas para su uso en lugares donde se prohíbe depositar cajas directamente en el suelo. Capacidad de carga de hasta 175 Kg por bancada, repartidos a lo largo de la bancada. Pie regulable para suelos desnivelados.

Conçus pour être utilisés quand il est interdit de poser les boîtes directement par terre. Charge maximale 175 Kg, distribués tout au long du banc. Pieds réglables pour sols irréguliers.

REF	W x D x H cm	
P7603	71,5 x 55,5 x 28	1
P7604	83,0 x 55,5 x 28	1
P7605	93,5 x 55,5 x 28	1
P7606	104,5 x 55,5 x 28	1
P7607	115,5 x 55,5 x 28	1
P7608	126,5 x 55,5 x 28	1
P7609	137,5 x 55,5 x 28	1
P7610	148,0 x 55,5 x 28	1
P7611	71,5 x 38,5 x 28	1
P7612	83,0 x 38,5 x 28	1
P7613	93,5 x 38,5 x 28	1
P7614	104,5 x 38,5 x 28	1
P7615	115,5 x 38,5 x 28	1
P7616	126,5 x 38,5 x 28	1
P7617	137,5 x 38,5 x 28	1
P7618	148,0 x 38,5 x 28	1

## Parts 11.4

Componentes  
Composants

### Shelf support fixing

Soporte fijación estantería  
Support fixation rayonnage



**Two pieces kit**  
Conjunto de 2 soportes  
Kit deux pièces

REF	
P76430	1



### Crossbars

Travesaños  
Longerons



REF	W cm	
P7632	65,5	1
P7633	77,0	1
P7634	87,5	1
P7635	98,5	1
P7636	109,5	1
P7637	120,5	1
P7638	131,5	1
P7639	142,0	1
P7640	153,0	1
P7641	164,5	1

### Rack-shelves

Parrillas  
Clayettes

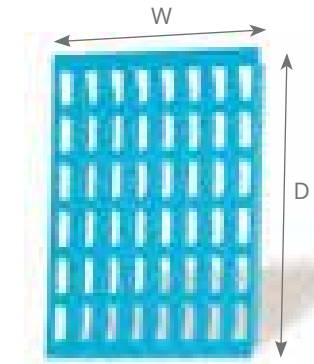

REF	Type / Tipo	W x D cm	GN For / Para / Pour	
P7628	Y	55,5 x 43,5	1/1	1
P7629	X	55,5 x 32,5	1/1	1
P7630	Y	38,5 x 43,5	2/3	1
P7631	X	38,5 x 32,5	2/3	1

### Hooks to form angles

Ganchos para formar ángulos  
Crochets pour faire les angles



REF	
P7642	1

### Support for crossbars

Pieza soporte para travesaños  
Support pour longerons

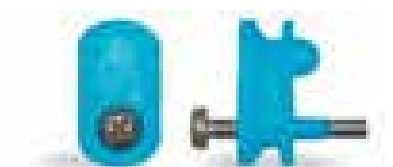

REF	
P7643	1

# 11.4 Parts

Componentes  
Composants

## Lateral supports Soportes laterales Suports latéraux



2 Available depths:  
55,5 cm, 1/1 gastronorm  
38,5 cm, 2/3 gastronorm

2 Fondos disponibles :  
55,5 cm, gastronorm 1/1  
38,5 cm, gastronorm 2/3

2 profondeurs disponibles:  
55,5 cm, gastronorm 1/1  
38,5 cm, gastronorm 2/3

## Lateral support with wheels Soportes laterales con ruedas Suports latéraux avec roues

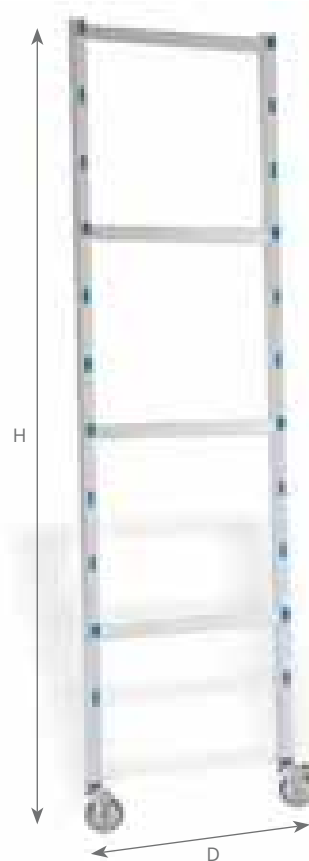

To assembly mobile shelving with wheels.  
Para montar estanterías móviles con ruedas.  
Pour monter rayonnages mobiles avec roues.

\* Height including wheel  
\* Altura con rueda incluida  
\* Hauteur avec la roue incluse

Wheels Ø 12,5 cm, two of them with brake.  
Ruedas de Ø 12,5 cm, dos de ellas con freno.  
Roues de Ø 12,5 cm, dont deux avec frein.

We do not recommend crossbars longer than 140 cm.  
No se recomiendan longitudes de travesaños superiores a 140 cm.  
Nous ne conseillons pas des longerons plus longs de 140 cm.

REF	MOD	D x H cm	Levels Niveles Niveaux	📦
P7585	S1	55,5 x 175	3	1
P7586	S2	55,5 x 175	4	1
P7587	S3	55,5 x 175	5	1
P7646	S0	55,5 x 200	4	1
P7588	S4	55,5 x 200	5	1
P7589	S5	55,5 x 200	6	1
P7590	S6	55,5 x 130	3	1
P7591	S7	38,5 x 175	3	1
P7592	S8	38,5 x 175	4	1
P7593	S9	38,5 x 175	5	1
P7647	S13	38,5 x 200	4	1
P7594	S10	38,5 x 200	5	1
P7595	S11	38,5 x 200	6	1
P7596	S12	38,5 x 130	3	1

REF	D x H cm	Niveles Levels Niveaux	📦
P7597	55,5 x 188	3	1
P7598	55,5 x 188	4	1
P7599	55,5 x 188	5	1

# Parts 11.4

Componentes  
Composants

## Shelves depth 38,5 cm Estantes fondo 38,5 cm Niveaux profondeur 38,5 cm

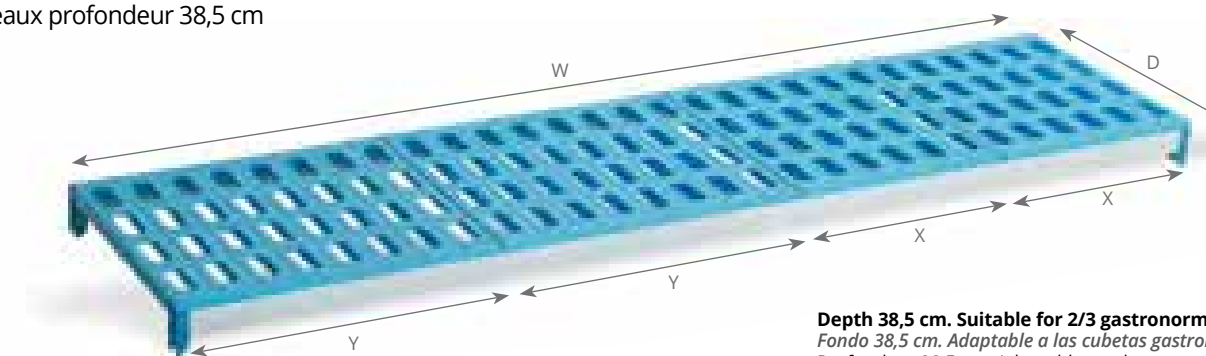

Depth 38,5 cm. Suitable for 2/3 gastronorm containers  
Fondo 38,5 cm. Adaptable a las cubetas gastronorm 2/3  
Profondeur 38,5 cm. Adaptable aux bacs gastronorm 2/3

X is a rack 32,5 cm width.  
Y is a rack 43,5 cm width.

X significa una parrilla de ancho 32,5 cm.  
Y significa una parrilla de ancho 43,5 cm.  
X est une clayette de 32,5 cm de largeur.  
Y est une clayette de 43,5 cm de largeur.

REF	MOD	Combinación Combinaison	W x D cm	📦
P7575	T61	X + X	65,5 x 38,5	1
P7576	T71	X + Y	77,0 x 38,5	1
P7577	T81	Y + Y	87,5 x 38,5	1
P7578	T91	X + X + X	98,5 x 38,5	1
P7579	T101	Y + X + X	109,5 x 38,5	1
P7580	T111	Y + Y + X	120,5 x 38,5	1
P7581	T131	Y + Y + Y	131,5 x 38,5	1
P7582	T141	Y + X + X + X	142,0 x 38,5	1
P7583	T151	Y + Y + X + X	153,0 x 38,5	1
P7584	T161	Y + Y + Y + X	164,5 x 38,5	1

## Shelves depth 55,5 cm Estantes fondo 55,5 cm Niveaux profondeur 55,5 cm

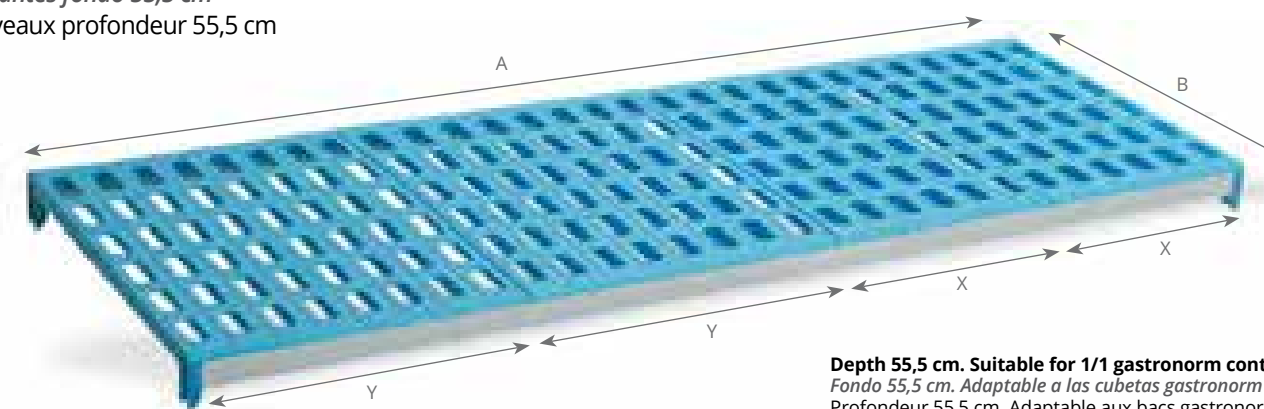

Depth 55,5 cm. Suitable for 1/1 gastronorm containers  
Fondo 55,5 cm. Adaptable a las cubetas gastronorm 1/1  
Profondeur 55,5 cm. Adaptable aux bacs gastronorm 1/1

X is a rack 32,5 cm width.  
Y is a rack 43,5 cm width.

X significa una parrilla de ancho 32,5 cm.  
Y significa una parrilla de ancho 43,5 cm.  
X est une clayette de 32,5 cm de largeur.  
Y est une clayette de 43,5 cm de largeur.

REF	MOD	Combinación Combinaison	W x D cm	📦
P7565	T6	X + X	65,5 x 55,5	1
P7566	T7	X + Y	77,0 x 55,5	1
P7567	T8	Y + Y	87,5 x 55,5	1
P7568	T9	X + X + X	98,5 x 55,5	1
P7569	T10	Y + X + X	109,5 x 55,5	1
P7570	T11	Y + Y + X	120,5 x 55,5	1
P7571	T13	Y + Y + Y	131,5 x 55,5	1
P7572	T14	Y + X + X + X	142,0 x 55,5	1
P7573	T15	Y + Y + X + X	153,0 x 55,5	1
P7574	T16	Y + Y + Y + X	164,5 x 55,5	1





# 12 Equipment

Maquinaria  
Equipement



## 12.1 COOKING 288

COCCIÓN / COUSSION

**Induction units / Placas inducción / Plaque induction** 288

**Warming induction units / Placas inducción mantenedoras** 292  
Plaque induction de maintien température

**Ovens & micro-waves / Hornos y micro-ondas / Fours et micro-ondes** 294

**Fryers / Freidoras / Friteuses** 295

## 12.2 TOASTERS & CONTACT GRILLS 296

TOSTADORAS Y GRILL DE CONTACTO

TOASTEURS ET GRILL DE CONTACT

**Toasters / Tostadoras / Toasteurs** 296

**Contact grill / Grill de contacto / Grill de contact** 301

## 12.3 FOOD PROCESSORS 302

PROCESADORES DE ALIMENTOS / ROBOTS MULTIFONCTION

**Mixers / Batidoras planetarias / Mélangeurs** 302

**Slicing machines / Corta fiambres / Trancheurs** 303

## 12.4 FOOD WARMING EQUIPMENT 304

MAQUINARIA MANTENEDORA DE TEMPERATURA

APPAREILS DE MAINTEN DE TEMPEÉRATURE

**Rethermalizers / Retermalizadores / Appareil de remise en température** 304

**Bain marie / Baños maría / Bain-marie** 310

**Heating lamps / Lámparas mantenedoras / Lampe chauffante** 315

**Warming equipment / Mantenedores de temperatura** 318  
Maintenance de température

**Hot banquet trolleys / Armarios calientes / Armoires chaudes** 319

## 12.5 ICE-CREAM MACHINES 322

MAQUINARIA HELADERÍA / TURBINES À GLACE

# Induction hobs

Placas inducción  
Plaques induction

**The new way of cooking: more efficient, faster, safer and more precise.**

*La nueva forma de cocinar: más eficiente, más rápida, más segura y más precisa.*

La nouvelle manière de cuisiner : plus efficace, plus rapide, plus sûre et plus précise.

## Energy efficient

*Eficiencia energética*  
Efficacité énergétique

**The electromagnetic field produced by induction hobs transmits the heat directly to the pan, avoiding the dispersal of energy that happens when cooking with gas.**

*El campo electromagnético producido por las placas de inducción transmite el calor directamente a la pieza evitando la dispersión de energía que se genera cocinando con gas.*

Le champ électromagnétique produit par les plaques à induction transmet la chaleur directement à la pièce en évitant la déperdition d'énergie générée quand on cuisine au gaz.

## Speed / Rapidez / Rapidité

**As heat is directly transmitted to the pan, it will be concentrated where it is needed, saving both energy and time.**

*Siendo transmitido directamente a la olla, el calor, se concentra donde se necesita ahorrando energía y, obviamente, tiempo.*

La chaleur étant transmise directement à la casserole, elle se concentre là où elle est nécessaire en économisant de l'énergie et, bien sûr, du temps.

## Precision / Precisión / Précision

**Thanks to their sensitivity, induction hobs give the chef an unbeatable ability to control the heat when compared to traditional hobs.**

*Gracias a su sensibilidad, las placas de inducción conceden al cocinero una capacidad de control incomparable con las cocinas tradicionales.*

Grâce à leur sensibilité, les plaques à induction offrent au cuisinier une capacité de contrôle sans comparaison avec les cuisinières traditionnelles.

## Safety / Seguridad / Sécurité

**Without anything on the hob to activate the magnetic field, the induction hobs do not heat up.**

*Sin una pieza específica que active el campo magnético, las placas de inducción no se calientan.*

À défaut d'une pièce adaptée capable d'activer le champ magnétique, les plaques ne chauffent pas.

# Induction hobs

Placas inducción  
Plaques induction

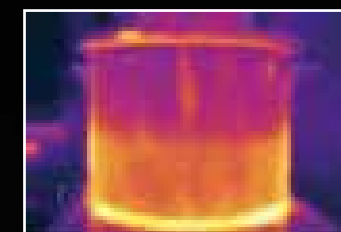

Induction hob  
Cocina de inducción  
Cuisinière à induction

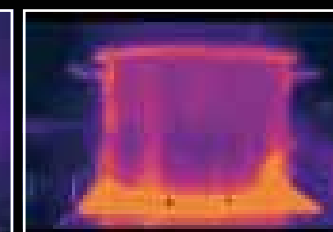

Gas hob  
Cocina de gas  
Cuisinière à gaz





# Which induction unit do you need?

¿Qué placa de inducción necesita?  
Quel plaque induction vous faut-il ?



**Cooking**  
Cocinado  
Cuisson

**Temperature maintenance**  
Mantenimiento temperatura  
Maintien en température

BRAND  
MARCA  
MARQUE

**VOLLRATH**

**pujadas**  
A VOLLRATH COMPANY

**VOLLRATH**

<b>MODEL</b> MODELO MODÈLE	HPI4	59650	59601	6954702	69523	6958302	P15078	P15072	P15079	P15077	P688065	595027502	595087502	59641
<b>POWER</b> POTENCIA PUISSANCE (W)	3.800 W	1.800 W	1.800 W	3.800 W	3.800 W	3.000 W	3.500 W	3.500 W	3.500 W	2.000 W	3.100 W	300 W	375 W	650 W
<b>MAX. DIAM.</b> DIÁMETRO MÁX. DIAMÈTRE MAX.	35,6 cm	26 cm	30,5 cm	30 x 2 cm	30 x 2 cm	35 cm	26 cm	26 cm	26 cm	26 cm	40 cm	40 cm	60 cm	36 cm
<b>HEAT DISSIP.</b> DISIP. CALOR DISSIP. CHALEUR														
<b>TYPE</b> TIPO TYPE	Counter-top Sobremesa À poser sur table	Counter-top Sobremesa À poser sur table	Be built-in Encastrable Encastrable	Counter-top Sobremesa À poser sur table	Counter-top Sobremesa À poser sur table	Counter-top Sobremesa À poser sur table	Counter-top Sobremesa À poser sur table	Counter-top Sobremesa À poser sur table	Counter-top Sobremesa À poser sur table	Counter-top Sobremesa À poser sur table	Counter-top Sobremesa À poser sur table	Counter-top Sobremesa À poser sur table	Counter-top Sobremesa À poser sur table	Be built-in Encastrable Encastrable
<b>SUITABLE</b> APTO CONVIENT	Pots / Pans Ollas / Sartenes Casserolles / Poêles	Pots / Pans Ollas / Sartenes Casserolles / Poêles	Pots / Pans Ollas / Sartenes Casserolles / Poêles	Pots / Pans Ollas / Sartenes Casserolles / Poêles	Pots / Pans Ollas / Sartenes Casserolles / Poêles	Wok	Pots / Pans Ollas / Sartenes Casserolles / Poêles	Pots / Pans Ollas / Sartenes Casserolles / Poêles	Pots / Pans Ollas / Sartenes Casserolles / Poêles	Pots / Pans Ollas / Sartenes Casserolles / Poêles	Wok	Pots / Chaffing dishes Ollas / Chaffing Casserolles / Chauffe-plats	Pots / Chaffing dishes Ollas / Chaffing Casserolles / Chauffe-plats	Pots / Chaffing dishes Ollas / Chaffing Casserolles / Chauffe-plats
<b>USE</b> USO USAGE	Intensive Intensivo Intensif	Semi-intensive Semi-intensivo Semi-intensif	Semi-intensive Semi-intensivo Semi-intensif	Intensive Intensivo Intensif	Intensive Intensivo Intensif	Semi-intensive Semi-intensivo Semi-intensif	Semi-intensive Semi-intensivo Semi-intensif	Semi-intensive Semi-intensivo Semi-intensif	Semi-intensive Semi-intensivo Semi-intensif	Moderate Moderado Modéré	Semi-intensive Semi-intensivo Semi-intensif	Intensive Intensivo Intensif	Intensive Intensivo Intensif	Intensive Intensivo Intensif

EQUIPMENT  
MAQUINARIA  
EQUIPEMENT

EQUIPMENT  
MAQUINARIA  
EQUIPEMENT

# 12.1 Induction units

Placas de inducción  
Plaque induction

## 4-Series

**IT'S LIKE COOKING WITH GAS, ONLY BETTER!**

Es como cocinar con gas, ¡solo que mejor!  
Comme la cuisine au gaz, mais en mieux!

- 93 % Efficiency**  
Eficiencia  
Efficacité
- 100 Power levels**  
Niveles de potencia  
Niveaux de puissance
- 27-232 °C Temperature levels**  
Niveles de temperatura  
Niveaux de température
- 24 h Timer with audible alarm**  
Temporizador con alarma sonora  
Minuterie avec alarme sonore
- Heavy-duty usage**  
Uso intensivo  
Intensif usage

Expanded magnetic field emulates gas to allow uninterrupted heat while lifting or tilting pan.

New smarter, faster pan detection technology delivers immediate heat when placing a pan on the surface.

Four customizable programs deliver repeatable results with the touch of a button.

El campo magnético expandido emula el gas para proporcionar un calor ininterrumpido mientras se levanta la sartén.

La nueva tecnología de detección más inteligente y rápida proporciona calor inmediato cuando se coloca la sartén sobre la superficie.

Cuatro programas personalizables ofrecen resultados repetibles con solo pulsar un botón.

Champ magnétique étendu qui imite la cuisson au gaz pour permettre une chaleur ininterrompue si la poêle est soulevée ou inclinée.

Nouvelle technologie de détection, plus intelligente et plus rapide qui apporte une chaleur immédiate lorsque la poêle est placée sur la surface.

Quatre programmes personnalisables avec des résultats répétables en appuyant sur un seul bouton.

**Ceramic glass cooking surface**  
Superficie de cocción de cristal vitrocerámico  
Surface de cuisson vitrocéramique

**Improved control knob with power and temperature level adjustment**  
Nuevo y mejorado mando de control de temperatura y potencia  
Nouveau bouton de contrôle de la température et la puissance amélioré

**Touch screen control panel**  
Panel de control con pantalla táctil  
Panneau de commande à écran tactile

**Redesigned sleek heavy-duty stainless steel case with improved ventilation**  
Nueva caja de acero inoxidable para uso intensivo con ventilación mejorada  
Nouveau boîtier en acier inoxydable pour usage intensif avec ventilation améliorée.

**Temperature control probe**  
Sonda de control de temperatura  
Sonde de contrôle de température

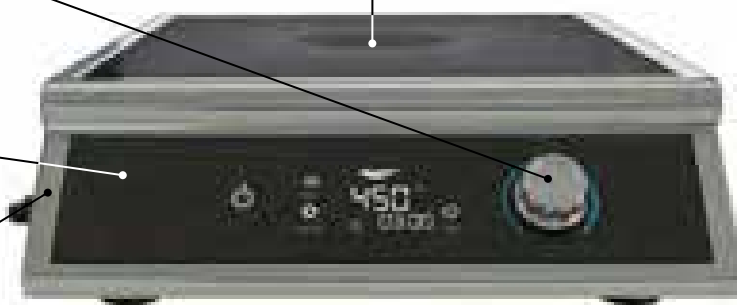

**NEW!**

**HPI4 High power induction**  
Placa de inducción control temperatura  
Plaque à induction contrôle température



REF	CA/AC Volt.	W	A	Plug Ench.	Hz	☐
HPI4-260002	230	2.600	11.3	EU	50/60	1
HPI4-260003	230	2.600	11.3	UK	50/60	1
HPI4-260004	230	2.600	11.3	CH	50/60	1
HPI4-300002	230	3.000	13	EU	50/60	1
HPI4-300003	230	3.000	13	UK	50/60	1
HPI4-300004	230	3.000	13	CH	50/60	1
HPI4-380002	230	3.800	16.5	EU	50/60	1
HPI4-380003	230	3.800	16	UK	50/60	1
HPI4-380004	230	3.800	16.5	CH	50/60	1

# Induction units 12.1

Placas de inducción  
Plaque induction

## mirage® INDUCTION

- 90 % Efficiency**  
Eficiencia  
Efficacité
- 100 Power levels**  
Niveles de potencia  
Niveaux de puissance
- 27-205 °C Temperature levels**  
Niveles de temperatura  
Niveaux de température
- 1-180 min Timer**  
Temporizador  
Minuterie
- Medium-duty usage**  
Uso semi-intensivo  
Semi-intensif usage

Temperature memory — powers up to the last used temperature setting.

Memoria de temperatura — permite usar el último ajuste de temperatura programado.

Mémoire de température — offre la possibilité d'utiliser le dernier réglage de température.

**Ceramic glass cooking surface**  
Superficie de cocción de cristal vitrocerámico  
Surface de cuisson vitrocéramique

**Control knob with power and temperature level adjustment**  
Mando de selección de temperatura y potencia  
Cadran de réglage de température et de puissance

**Soft-touch control panel**  
Panel de control táctil  
Panneau de commande tactile

**Tough stainless steel case**  
Resistente caja de acero inoxidable  
Boîtier inox solide



**59650 Induction cooker**  
Placa inducción  
Plaque induction



REF	Ø Mâx cm	V	W	A	Plug Ench.	Hz	☐
59650	26	230	1.800	7,8	EU	50/60	1
59651	26	230	1.800	7,8	UK	50/60	1

**59601 Drop in induction cooker**  
Placa inducción encastrable  
Plaque induction encastrable

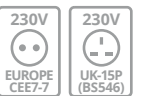

REF	Ø Mâx cm	cm	V	W	A	Plug Ench.	Hz	☐
59601	30,5	34 x 30	230	1.800	7,8	EU	50/60	1
59602	30,5	34 x 30	230	1.800	7,8	UK	50/60	1

# 12.1 Induction units

Placas de inducción  
Plaque induction

**69547 Double induction plate**  
Placa inducción doble  
Plaque à induction double

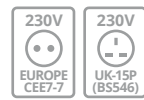

1.900W x 2



REF	Ø cm	V	W	A	Plug Ench.	Hz	⊠
6954702	30 x 2	208-240	3.800	15,8	EU	50/60	1
6954703	30 x 2	208-240	3.800	15,8	UK	50/60	1

**69523 Double induction plate**  
Placa inducción doble  
Plaque à induction double



1.900W x 2



REF	Ø cm	V	W	A	Plug Ench.	Hz	⊠
69523	30 x 2	208-240	2.900	24,1	NEMA	50/60	1

**P15078 Induction cooker**  
Placa de inducción  
Plaque à induction



REF	Ø Màx cm	V	W	Hz	⊠
P15078	26	220 - 240	3.500	50/60	1

St/steel housing. Timer. LED display (0-180 minutes). Touch control. 1-10 Power level (500-3500W). Temperatures: 60-240 °C. Four fans.

Cuerpo en acero inoxidable. Reloj temporizador (0-180 minutos). Pantalla LED con control táctil. Regulador de temperatura 1-10 (500-3500W). Rango temperatura 60-240 °C. Cuatro ventiladores de refrigeración.

Corps en acier inoxydable. Minuteur. Ecran LED (0-180 minutes). Tactile. 1-10 Niveau de puissance (500-3500W). Temperatures: 60-240 °C. Quatre ventilateurs.

**P15072 Induction cooker**  
Placa de inducción  
Plaque à induction



REF	Ø Màx cm	V	W	Hz	⊠
P15072	26	230	3.500	50/60	1

St/Steel housing. Digital regulation of time 0-180 minutes. Thermostat 60-240 °C and power 500-3500 W. 4 Fans.

Cuerpo en acero inoxidable. Mando digital de tiempo de 0-180 minutos. Temperatura de 60-240 °C. Potencia de 500-3500 W. 4 Ventiladores.

Corps en acier inoxydable. Minuterie digitale de 0-180 minutes. Température de 60-240 °C. Puissance: 500-3500 W. 4 Ventilateurs.

# Induction units 12.1

Placas de inducción  
Plaque induction

**P15079 Induction cooker**  
Placa de inducción  
Plaque à induction



REF	Ø Màx cm	V	W	Hz	⊠
P15079	26	230	3.500	50/60	1

St/steel housing. Timer. LED display (0-180 minutes). Temperatures: 60-240 °C. One fan.

Cuerpo en acero inoxidable. Reloj temporizador (0-180 minutos). Pantalla LED. Rango temperatura 60-240 °C. Un ventilador de refrigeración.

Corps en acier inoxydable. Minuteur. Ecran LED (0-180 minutes). Temperatures: 60-240 °C. Un ventilateur.

**P688065 Wok induction cooker**  
Placa de inducción wok  
Plaque à induction wok



REF	Ø cm	V	W	Plug Ench.	Hz	⊠
P688065	36/40	220-240	3.100	EU	50/60	1

St/steel housing. Timer (0-180 minutes). LED display. Temperatures: 60-240 °C. 4 fans.

Cuerpo en acero inoxidable. Reloj temporizador (0-180 minutos). Pantalla LED. Temperatura 60-240 °C. 4 ventiladores.

Corps en acier inoxydable. Minuteur (0-180 minutes). Ecran LED. Temperatures: 60-240 °C. 4 ventilateurs.

**P15077 Induction cooker**  
Placa de inducción pequeña  
Plaque induction petite



REF	Ø Màx cm	V	W	Hz	⊠
P15077	26	230	2.000	50/60	1

Plastic housing with touch control LCD panel. Timer (0-180 minutes). Temperatures: 60-240 °C.

Cuerpo en plástico con panel control táctil LCD. Reloj temporizador (0-180 minutos). Rango temperaturas: 60-240 °C.

Corps en plastique avec écran LCD tactile. Minuteur (0-180 minutes). Temperatures: 60-240 °C.

**6958302 Placa de inducción control wok 35 cm**  
Placa de inducción wok 35 cm  
Plaque à induction contrôle wok35 cm



REF	CA/AC Volt.	W	A	Plug Ench.	Hz	⊠
6958302	208-240	3000	14.6	EU	50/60	1
6958303	208-240	3000	14.6	UK	50/60	1

Includes a carbon steel wok. High efficiency of induction to provide gas-like performance. 100 power settings for precise cooking control.

Incluye un wok de acero al carbono. Alta eficiencia de inducción para proporcionar un rendimiento similar al del gas. 100 configuraciones de potencia para un control preciso de la cocción.

Comprend une poêle wok en acier au carbone. Haute efficacité d'induction pour fournir des performances similaires à celles d'un gaz. 100 réglages de puissance pour un contrôle précis de la cuisson.

## 12.1 Warming induction units

Placas inducción mantenedoras  
Plaque induction de maintien température

**mirage**<sup>®</sup>  
INDUCTION



### BUFFET INDUCTION WARMER BUFET CALENTADORES INDUCCIÓN BUFFET RECHAUD INDUCTION

**Low wattage to keep food warm during serving.**  
*Mantener la comida caliente durante el servicio.*  
Faible puissance pour garder les aliments au chaud pendant le service.

**With less than 400W, it is the most efficient and eco-friendly system on the market.**

*Con menos de 400W son el sistema más eficiente y eco-friendly del mercado.*

*Avec moins de 400 W c'est le système le plus efficace et eco-friendly du marché.*



**Tempered, black glass top.**  
*Parte superior de cristal templado negro.*  
Plateau en verre noir trempé.

**Touch control, 4 power settings. LED indicator lights on control panel & glass.**  
*Con 4 ajustes de potencia. Indicadores luminosos LED en el panel de control.*  
Contrôle tactile, 4 réglages de puissance. Voyants LED lumineux sur le panneau de commande et verre.



**Connect up to 3 units together with interconnect cords.**  
*Conecte hasta 3 placas a la vez.*  
Connectez jusqu'à 3 unités avec des cordons d'interconnexion.

## Warming induction units 12.1

Placas inducción mantenedoras  
Plaque induction de maintien température

### 595027502 Buffet induction warmer Placa inducción mantenedora de temperatura Plaque induction de maintien température



595087502  
595087503



595027502  
595027503

REF	W x D x H cm	CA/AC Volt.	W	A	Plug Ench.	Hz	☐
595027502	40 x 40 x 8	230	300	1,30	EU	50/60	1
595027503	40 x 40 x 8	230	300	1,30	UK	50/60	1
595087502	60 x 40 x 8	230	375	1,63	EU	50/60	1
595087503	60 x 40 x 8	230	375	1,63	UK	50/60	1

### 59641 Drop in warmer Placa inducción mantenedora de temperatura encastrable Plaque induction de maintien température encastrable



\* Drop in  
Encastrable  
Encastrable

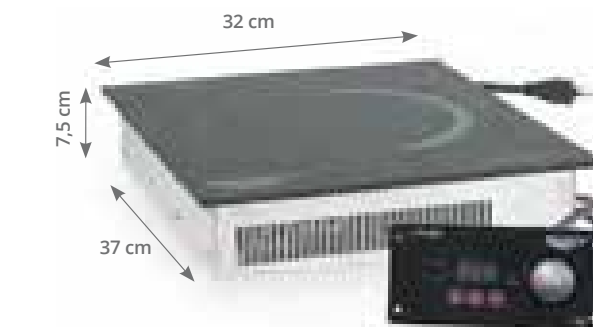

REF	Ø Mâx cm	cm*	CA/AC Volt.	W	A	Plug Ench.	Hz	☐
59641	36	34 x 30	230	650	2,8	EU	50/60	1
59642	36	34 x 30	230	650	2,8	UK	50/60	1

# 12.1 Ovens & micro-waves

Hornos y micro-ondas  
Fours et micro-ondes

**P15035 Convection oven**  
Horno multifuncional de convección  
Four à air pulse



REF	Grill / Rejilla / Grille	V	W	Hz	
P15035	43 x 32	230	2.670	50/60	1

4 grids included  
4 rejillas incluidas  
4 grilles incluses

Timer, indicator lights, thermostat, (max. 300 °C) thermal cut-out and double glass.

Temporizador, pilotos luminosos, termostato (max. 300 °C), termostato de seguridad y doble vidrio anti-quemaduras.

Avec minuterie, voyants lumineux, thermostat (max. 300 °C), thermostat de sécurité et avec double vitre. mostat, thermostat de sécurité et avec vitre double

**P688085 Rice cooker**  
Hervidor de arroz  
Cuseur à riz



REF	Ø cm	Rice cap. / Cap. arroz / Riz cap. Kg	Lts	H cm	V	W	Hz	
P688085	46	3,0	5,40	40	220-230	1950	50/60	1
P688087	56	6,1	8,20	40	220-240	2500	50/60	1

**P15081 Combi micro - wave**  
Microondas combi  
Four micro - ondas

**10 Power levels**  
Niveles de potencia  
Niveaux de puissance



REF	Lts	Inner sizes / Dim int / Dim. int. cm	V	Max W	Hz	
P15081	25,0	33,5 x 33,5 x 17	230	1.950	50	1

Input: 1.400 W  
Output: 900 W  
Convection / Convección: 1.950 W

Glass round dish  
Plato giratorio  
Plateau tournant

Functions: defrosting, baking and heating  
Funciones: descongelar, gratinar y calentar  
Fonctions: décongeler, gratiner et chauffer

**P15075 Crêpe maker**  
Crêpera  
Crêpière

Thermostat  
Termostato  
Thermostat:  
Temp. Max 300 °C



St/Steel with cast iron teflon coated plates. Indicator light, drawer/warming tray and batter spreader.

Acero inoxidable con planchas de hierro fundido teflonadas. Indicador temperatura, cajón y espátula.

Acier inoxydable avec plaques en fonte avec revêtement en téflon. Témoin de contrôle, tiroir/plaque chauffante et étaleur de pâte.

REF	Ø cm	cm	V	W	Hz	
P15075	40	45 x 49	230	3.000	50/60	1

# Fryers 12.1

Freidoras  
Friteuses

18/10  
Stainless  
steel

Temperature control up to 190°C  
Temperatura variable hasta 190°C  
Température variable jusqu'à 190°C

**P15070 5 Lts fryer**  
Freidora 5 Lts  
Friteuse 5 Lts

Thermo-resistant handle  
Mango termoresistente  
Manche thermorésistant

Temperature control  
Control de temperatura  
Contrôle de la température

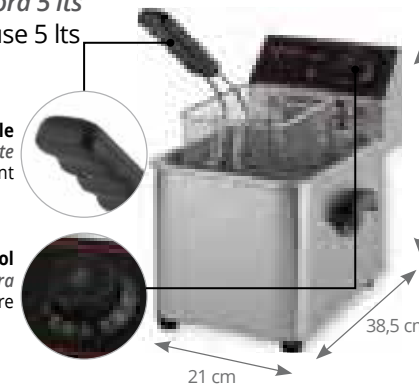

REF	Lts	V	W	Hz	
P15070	5,00	230	2.000	50/60	1

Basket size / Medida cesta / Mesure panier 21 x 14 x 12,5 cm

**P15000 8 Lts Fryer**  
Freidora 8 Lts  
Friteuse 8 Lts



REF	Lts	V	W	Hz	
P15000	8,00	230	3.250	50/60	1

Basket size / Medida cesta / Mesure panier 24 x 18 x 14 cm

**P15002 8 Lts fryer with drainage tap**  
Freidora 8 Lts con grifo de vaciado  
Friteuse 8 Lts avec robinet vidange

Drain valve  
Grifo de drenaje  
Robinet de vidange

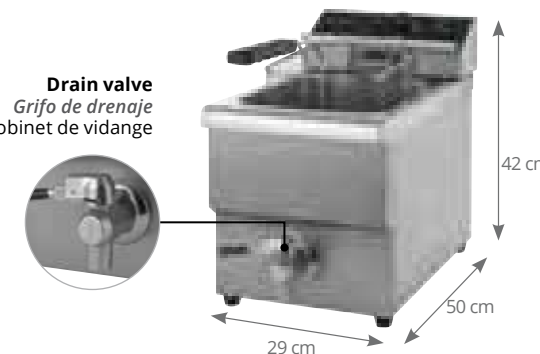

REF	Lts	V	W	Hz	
P15002	8,00	230	3.250	50/60	1

Basket size / Medida cesta / Mesure panier 24 x 18 x 14 cm

**P15071 5+5 Lts fryer**  
Freidora 5+5 Lts  
Friteuse 5+5 Lts



REF	Lts	V	W	Hz	
P15071	5,00+5,00	2 x 230	2 x 2.000	50/60	1

Basket size / Medida cesta / Mesure panier 21 x 14 x 12,5 cm

**P15001 8+8 Lts Fryer**  
Freidora 8+8 Lts  
Friteuse 8+8 Lts



REF	Lts	V	W	Hz	
P15001	8,00+8,00	2 x 230	2 x 3.250	50/60	1

Basket size / Medida cesta / Mesure panier 24 x 18 x 14 cm

**P15003 8+8 Lts fryer with drainage tap**  
Freidora 8+8 Lts con grifo de vaciado  
Friteuse 8+8 Lts avec robinet vidange



REF	Lts	V	W	Hz	
P15003	8,00+8,00	2 x 230	2 x 3.250	50/60	1

Basket size / Medida cesta / Mesure panier 24 x 18 x 14 cm

# 12.2 Toasters

Tostadoras  
Toaster



**Save up to 75% energy\***  
Ahorre hasta un 75% de energía\*  
Économisez jusqu'à 75% d'énergie\*

**CONVEYOR TOASTERS**  
Forced convection and energy-efficient quartz resistors provide a uniform and fast toasting.

\* The Stand by function saves 75% of energy during periods of low demand.

**TOSTADORAS CON CORREA TRANSPORTADORA**  
La convección forzada y las resistencias de cuarzo energéticamente eficientes brindan un tostado uniforme y rápido.

\*La función en Stand by permite ahorrar un 75% de energía en el momento de baja demanda.

**GRILLE-PAIN CONVOYEURS**  
La convection forcée et les résistances à quartz énergétiquement efficaces offrent un grillage uniforme et rapide.

\*La fonction Stand by permet d'économiser 75% d'énergie aux moments de faible demande.

**CT4-230DUAL Dual conveyor toaster**  
Tostadora transportadora doble  
Pain double à convoyeur



**NEW!**



**Conveyor width**  
Ancho de cinta  
Largeur de bande  
**36,8 cm**

**Delivered without plug (stripped ends).**  
Entregado sin clavija.  
Livré sans prise.

**1100**  
Slices per hour  
Rebanadas por hora  
Tranches heure

REF	V	W	Hz	A	⊠
CT4-230DUAL	220-240	4.950	50/60	19,8	1

**CT4H-230950 Conveyor toaster**  
Tostadora continua  
Pain à convoyeur



**NEW!**



**Conveyor width**  
Ancho de cinta  
Largeur de bande  
**36,8 cm adjustable**

**Delivered without plug (stripped ends).**  
Entregado sin clavija.  
Livré sans prise.

**950**  
Slices per hour  
Rebanadas por hora  
Tranches heure

REF	V	W	Hz	A	⊠
CT4H-230950	220-240	3.600	50/60	14,4	1

# Toasters 12.2

Tostadoras  
Toaster

18/10  
Stainless steel

**CT4-3600W Conveyor toaster**  
Tostadora continua  
Grille - pain à convoyeur



**Speed control**  
Control de velocidad  
Contrôle de vitesse

**Stand-by system**  
Sistema stand-by  
Système stand-by

**Temperature control**  
Control de temperatura  
Contrôle de la température

**Conveyor width**  
Ancho de cinta  
Largeur de bande  
**35,6 cm**

**Delivered without plug (stripped ends).**  
Entregado sin clavija.  
Livré sans prise.

**Replaceable quartz resistance.**  
Resistencias de cuarzo recambiables.  
Résistances à quartz remplaçables.

**1.000**  
Rebanadas por hora  
Slices per hour  
Tranches heure

REF	V	W	Hz	A	WxDxH cm	⊠
CT4-2301000	230	3.600	50/60	15	35 x 46 x 35,6	1

**CT2-1500W Conveyor toaster**  
Tostadora continua  
Grille - pain à convoyeur



**Conveyor width**  
Ancho de cinta  
Largeur de bande  
**26,7 cm**



**CT4-2800W Conveyor toaster**  
Tostadora continua  
Grille - pain à convoyeur

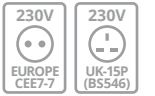

**Speed and temperature control.**  
Replaceable quartz resistance.

Dispone de control de velocidad y temperatura.  
Resistencias de cuarzo recambiables.

Avec contrôle de la vitesse et température. Résistances à quartz remplaçables.

**Conveyor width**  
Ancho de cinta  
Largeur de bande  
**26,7 cm**

**450-800**  
Slices per hour  
Rebanadas por hora  
Tranches heure

REF	V	W	Hz	A	WxDxH cm	Plug Ench.	⊠
CT4-23080002	230	2.800	50/60	12,7	35 x 36 x 60	EU	1
CT4-23080003	230	2.800	50/60	12,7	35 x 36 x 60	UK	1

REF	V	W	Hz	A	WxDxH cm	Plug Ench.	⊠
CT2-23035002	230	1.500	50/60	12,5	35 x 36 x 41	EU	1
CT2-23035003	230	1.500	50/60	12,5	35 x 36 x 41	UK	1

**350**  
Slices per hour  
Rebanadas por hora  
Tranches heure

**Speed control.**  
Replaceable quartz resistance.

Dispone de control de velocidad.  
Resistencias de cuarzo recambiables.

Avec contrôle de la vitesse.  
Résistances à quartz remplaçables.

## 12.2 Toasters

Tostadoras  
Toaster

SS  
Stainless  
steel

### Conveyor heating oven / Horno de cinta / Four chauffant à bande

Designed to heat any type of snack and melt cheese quickly and efficiently. Made of stainless steel with a variable speed control system and temperature control both above and below the conveyor belt. It includes a crumb collection tray. It has a forced convection system and has the possibility of regulating the height of the belt, ensuring uniform toasting and the highest energy efficiency. Two units can be mounted one top of the other with a space-saving accessory.

Diseñado para calentar cualquier tipo de snack y fundir queso de manera rápida y eficiente. Fabricado en acero inoxidable con un sistema de control de la velocidad variable y control de temperatura tanto por encima como por debajo de la cinta. Incluye bandeja para recoger migas. Su sistema de convección forzada y la posibilidad de regular la altura de la cinta, aseguran un tostado uniforme y la mayor eficiencia energética. Pueden remontarse dos unidades al mismo tiempo con un accesorio para ahorrar espacio.

Conçue pour préparer toute sorte de snack et faire fondre le fromage rapidement et efficacement. Fabriqué en acier inoxydable avec un système de contrôle de vitesse variable et un contrôle de température au-dessus comme en-dessous de la bande. Inclut bac de récupération de miettes. Son système de convection forcée et la possibilité de régler la hauteur de la bande, assurent un grillé uniforme et la meilleure efficacité énergétique. Il est possible de remonter deux unités à la fois avec un accessoire pour économiser de l'espace.

#### SO2-2800W Conveyor heating oven Horno calentador de cinta Four chauffant à bande

CE



**26,7 cm**

Belt width / Ancho de cinta  
Largeur de la bande

**3,8 - 7,6 cm**

Adjustable entrance height  
Altura entrada ajustable  
Hauteur de l'entrée réglable

REF	V	W	Hz	A	WxDxH cm	Plug Ench.	Box
SO2-23010.5	230	2.800	50	13,3	34 x 104 x 41	EU	1

#### SO2-3600W Conveyor heating oven Horno calentador de cinta Four chauffant à bande

CE



**36,8 cm**

Belt width / Ancho de cinta  
Largeur de la bande

**3,8 - 7,6 cm**

Adjustable entrance height  
Altura entrada ajustable  
Hauteur de l'entrée réglable

REF	V	W	Hz	A	WxDxH cm	Plug Ench.	Box
SO2-23014.5	230	3.600	50	13,3	39 x 103,5 x 51	EU	1

See products on / Ver productos en / Voir produits en page

P. 446

**Wooden bread spoon**  
Pinza de pan de madera  
Pince à pain en bois



**Idea!** Ideal for handling toast  
Ideal para manipular las tostadas  
Idéal pour manipuler le pain grillé

## Toasters 12.2

Tostadoras  
Toaster

SS  
Stainless  
steel

### Standard Toasters / Tostadoras Estándar / Toasteurs Standard

#### P15042 Conveyor toaster Tostadora continua Toasteur convoyeur

CE

500

Rebanadas por hora  
Slices per hour  
Tranches heure



#### P15038 Sandwich toaster Tostadora Toasteur

CE



**80-100**

Slices per hour  
Rebanadas por hora  
Tranches heure

Delivered with 3 sandwich tongs  
Se entregan con 3 pinzas para sandwich  
Livrées avec 3 pinces à sandwich

REF	V	W	Hz	Box
P15038	230	1.700	50/60	1

Heating elements separately controllable. With timer, drip tray and 4 quartz heating elements.

Las resistencias se pueden controlar por separado. Con temporizador y bandeja limpieza recoge migas. 4 tubos de cuarzo.

Les résistances se contrôlent séparément. Avec minuterie, tiroir ramasse miettes et 4 tubes quartz.

REF	V	W	Hz	Box
P15042	230	2.240	50/60	1

Toast colour can be determined by conveyor speed as well as by independently controlled heating elements. Units are fully insulated to emit only minimal heat to surroundings. Main switch with extra standby position. The toasters can be used for bread as well as for buns. The toasting belt is suitable for 2 rows for toast, 200 type.

El color de las tostadas puede determinarse por la velocidad de la banda transportadora, así como por las resistencias superior e inferior que se controlan independientemente. El aparato está completamente aislado para que emita un calor mínimo a su alrededor. El interruptor encendido-apagado contempla la posición extra de standby. La longitud de la banda transportadora permite 2 hileras de tostadas (tipo 200).

La couleur du pain se détermine par la vitesse de la bande de transport ainsi que par les résistances contrôlées indépendamment. Les appareils sont isolés entièrement et n'émettent qu'une chaleur minimale à la température ambiante. Interrupteur marche-arrêt qui inclut le mode veille standby. La Largeur de la bande de transport permet 2 rangées de tranches, type 200.

#### P15039 Sandwich toaster Tostadora Toasteur

CE



**120-130**

Slices per hour  
Rebanadas por hora  
Tranches heure

Delivered with 6 sandwich tongs  
Se entregan con 6 pinzas para sandwich  
Livrées avec 6 pinces à sandwich

REF	V	W	Hz	Box
P15039	230	3.000	50/60	1

2 levels. Heating elements separately controllable. With timer, drip tray and 9 quartz heating elements.

2 niveles. Las resistencias funcionan por separado. Con temporizador, bandeja recoge migas. 9 tubos de cuarzo.

2 niveaux. Les résistances se contrôlent séparément. Avec minuterie, tiroir ramasse miettes et 9 tubes quartz.

# 12.2 Toasters

Tostadoras  
Toaster

**P15040 Toaster**  
Tostadora  
Toasteur



**120**  
Rebanadas por hora  
Slices per hour  
Tranches heure

REF	Slots Ranuras / Fentes	V	W	Hz	
P15040	4	230	1.800	50/60	1

With manual pop up  
Con expulsión manual  
Avec éjection automatique

All St/Steel construction.  
With energy-saving switch to decide how many slices to toast. With timer: 2 or 4  
Slot: 2,5 x 14,5 x 14,5 cm.

Fabricada en acero inoxidable.  
Con conmutador ahorro energía para decidir la cantidad de rebanadas a tostar: 2 ó 4  
Con temporizador.  
Ranura: 2,5 x 14,5 x 14,5 cm.

Habillage en acier inoxydable.  
Avec commutateur économiseur pour choisir le nombre de tranches à griller: 2 ou 4  
Avec minuterie.  
Fente: 2,5 x 14,5 x 14,5 cm.

**P15041 Toaster**  
Tostadora  
Toasteur



**180**  
Rebanadas por hora  
Slices per hour  
Tranches heure

REF	Slots Ranuras / Fentes	V	W	Hz	
P15041	6	230	2.500	50/60	1

With manual pop up  
Con expulsión manual  
Avec éjection automatique

All St/Steel construction.  
With energy-saving switch to decide how many slices to toast. With timer: 2 or 4 or 6  
Slot: 2,5 x 14,5 x 14,5 cm.

Fabricada en acero inoxidable.  
Con conmutador ahorro energía para decidir la cantidad de rebanadas a tostar: 2 ó 4 ó 6  
Con temporizador.  
Ranura: 2,5 x 14,5 x 14,5 cm.

Habillage en acier inoxydable.  
Avec commutateur économiseur pour choisir le nombre de tranches à griller: 2 ou 4 ou 6  
Avec minuterie.  
Fente: 2,5 x 14,5 x 14,5 cm.

# Contact grill 12.2

Grill de contacto  
Grill de contact



CAST IRON GRIDDLE PLATES.  
Large drip tray.  
High turned-up spatter rim.  
Indicator lights.  
Adjustable thermostat to 300 °C.

PLANCHAS DE FUNDICIÓN.  
Bandeja y recoge jugos.  
Borde antisalpicaduras.  
Luces piloto.  
Termostato ajustable hasta 300 °C.

PLAQUE EN FONTE.  
Tiroir de propreté.  
Bourdre anti projections haute.  
Voyants lumineux.  
Thermostat réglable jusqu'à 300 °C.

**P15004 "Solo compact" Contact grill**  
Grill de contacto "Solo compact"  
Grill de contact "Solo compact"



Upper and lower grooves  
Ranura arriba y abajo  
Quadrillage en haut et en bas



Temperature control  
Control de temperatura  
Contrôle de la température



Fat collection tray  
Bandeja recoge grasa  
Bac de récupération de graisse

REF	Cooking surface Superficie de cocción Surface de cuisson cm	V	W	Hz	
P15004	22 x 23	230	1.800	50/60	1

**P15005 "Solo grande" Contact grill**  
**P15006** Grill de contacto "Solo grande"  
Grill de contact "Solo grande"



Upper and lower grooves  
Ranura arriba y abajo  
Quadrillage en haut et en bas  
P15005

Upper groove  
Ranura arriba  
Quadrillage en haut  
P15006

**P15007 "Duetto compact" Contact grill**  
**P15008** Grill de contacto "Duetto compact"  
Grill de contact "Duetto compact"



Upper and lower grooves  
Ranura arriba y abajo  
Quadrillage en haut et en bas  
P15007

Upper groove  
Ranura arriba  
Quadrillage en haut  
P15008

REF	Cooking surface Superficie de cocción Surface de cuisson cm	V	W	Hz	
P15005	32 x 21	230	2.200	50/60	1
P15006	32 x 21	230	2.200	50/60	1

REF	Cooking surface Superficie de cocción Surface de cuisson cm	V	W	Hz	
P15007	47 x 23	230	3.600	50/60	1
P15008	47 x 23	230	3.600	50/60	1

Included on the price  
Incluido en el precio  
Inclus dans le prix

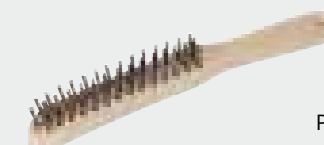

P181000



## 12.3 Mixers

Batidoras planetarias  
Mélangeurs

### Mixers Batidoras planetarias Mélangeurs

**Gears and shafts are made of heat-treated alloy steel for long life and quieter operation**

Engranajes y ejes de acero de fundición permiten alargar la vida del producto y proporcionan un funcionamiento más silencioso

Engrenages et arbres en acier allié traité à la chaleur pour une longue durée et un fonctionnement plus silencieux

**Planetary mixing action**  
Acción de batido elíptico  
Mélangeur planétaire



**Thermal overload protection automatically shuts off mixer to protect from damage**  
Paro automático por sobre calentamiento  
Arrêt automatique par la surchauffe

**30 minute digital timer with automatic stop and audible shutoff signal**  
Temporizador digital 30 minutos, con paro automático con señal acústica  
Minuterie numérique (30 minutes) à arrêt automatique et signal d'arrêt sonore

**Consistent mixing speeds regardless of volume**  
Velocidades de mezcla constantes independientemente del volumen  
Vitesses de mélange uniformes, quel que soit le volume

**Safety guard**  
Protección Seguridad  
Protecteur de sécurité

**Heavy-duty construction**  
Construcción extra robusta  
Construction robuste

Comes with / Incluye / Livré avec



**Wire Wishk**  
Batidor varilla  
Fouet à fil



**Dough hook**  
Gancho para masa  
Crochet de pâte



**Spatula**  
Espátula  
Spatule



**S/Steel mixing bowl**  
Bol acero inoxidable  
Bol mélangeur en acier inoxydable



### 4075502 Countertop Mixers Amasadora sobre mesa Mélangeurs de comptoir

**1/3 HP  
250 W  
3 A  
50 Hz**



4075503

**Digital control panel to make easy speed shifts while unit is running.**  
Panel de control digital para simplificar el cambio de velocidades mientras la unidad está funcionando.  
Panneau de commande numérique pour faciliter les changements de vitesse pendant le fonctionnement de l'appareil

REF	Lts.	W x D x H cm	Speed Velocidad Vitesse	V	Plug Ench.	☐
4075502	6,6	33,5x45x51,5	5	220-230	EU	1
4075503	6,6	33,5x45x51,5	5	220-230	UK	1
4075602	9,5	33,5x45x54	5	220-230	EU	1
4075603	9,5	33,5 x 45 x 54	5	220-230	UK	1

REF	For / Para / Pour (Lts)	☐
<b>Wire Wishk / Batidor varilla / Fouet à fil</b>		
XMIX0705	6.6	1
40762	9.5	1
<b>Dough hook / Gancho para masa / Crochet de pâte</b>		
XMIX0704	6.6	1
40763	9.5	1
<b>Spatula / Espátula / Spatule</b>		
XMIX0703	6.6	1
40764	9.5	1
<b>Mixing bowl / Bol acero / Bol mélangeur</b>		
XMIX0702	6.6	1
40761	9.5	1

## Slicing machines 12.3

Corta fiambres  
Trancheurs

### 4075702 Floor-Bench mixers Amasadora de pié Mélangeurs au sol-sur plan de travail



**220-230 V  
50 Hz**



4075702

REF	Lts.	W x D x H cm	Speed Velocidad Vitesse	HP	W	A	Plug Ench.	☐
4075702	19	52x52x91	3	0,5	370	4	EU	1
4075703	19	52x52x91	3	0,5	370	4	UK	1
4075802	28	64x62x122	3	1,0	750	8	EU	1
4075803	28	64x62x122	3	1,0	750	8	UK	1
4075902	38	68x68x120	3	1,5	1.120	11	EU	1
4075903	38	68x68x120	3	1,5	1.120	11	UK	1

REF	For / Para / Pour (Lts)	☐
<b>Wire Wishk / Batidor varilla / Fouet à fil</b>		
40766	19	1
40770	28	1
40774	38	1
<b>Dough hook / Gancho para masa / Crochet de pâte</b>		
40767	19	1
40771	28	1
40775	38	1
<b>Spatula / Espátula / Spatule</b>		
40768	19	1
40772	28	1
40776	38	1
<b>Mixing bowl / Bol acero / Bol mélangeur</b>		
40765	19	1
40769	28	1
40773	38	1

### P15089 / P15090 / P15091 Electric slicing machine Cortadora eléctrica de fiambres Tranchar électrique



**Body: painted aluminium.**  
Cuerpo: aluminio pintado.  
Corps: aluminium peint.

REF	V	Hz	W	Ø Blade Cuchilla /Lame	Slicer thickness Espesor corte /Épaisseur de coupe	W x D x H cm	Kg	☐
P15089	230	50	120	22	0-9	48 x 40 x 37	14,8	1
P15090	230	50	150	25	0-9	48 x 40 x 37	16,0	1
P15091	230	50	250	30	0-11	59 x 38 x 43	22,6	1



P15089  
Ø 22 cm Blade / Cuchilla / Lame



P15090  
Ø 25 cm Blade / Cuchilla / Lame



P15091  
Ø 30 cm Blade / Cuchilla / Lame

See products on / Ver productos en / Voir produits en page

P. 141

**Sanitary gel lubricant**  
Gel lubricante sanitario  
Gel lubrifiant sanitaire



# Which warming equipment do you need?



¿Qué mantenedor de temperatura necesitas?  
 Quel appareil maintenance de température vous faut-il ?



**Rethermalizers** *Application: Retherm Chilled Food. Hold Heated Food.*  
**Rethermalizadores** *Aplicación: Retermaliza alimentos fríos. Mantiene calientes los alimentos.*  
**Ap. de remise en température** *Aplicación: Retermaliza alimentos fríos. Mantiene calientes los alimentos.*

**Warmers** *Application: Hold Heated Food.*  
**Calentadores** *Aplicación: Mantiene calientes los alimentos.*  
**Chaud** *Application: Tenir les aliments chauffés.*

	<b>INDUCTION 3D</b>	<b>RETRO</b>	<b>CAYENNE</b>	<b>CAYENNE</b>
				
<b>Warmer and rethermalizer</b> <i>Calentadores y rethermalizadores</i> <i>Ap. de remise à température et</i> <i>ap. de maintien à température</i>	✓	✓	✓	✓
<b>Warmer only</b> <i>Solo calentador</i> <i>Chauffant seulement</i>				
<b>Power (W)</b> <i>Potencia (W)</i> <i>Puissance (W)</i>	800	1.400	800	1.000
<b>Direct contact heating system</b> <i>Calentamiento a través de</i> <i>contacto directo</i> <i>Système de chauffage par</i> <i>contact direct</i>			✓	✓
<b>Water</b> <i>Agua</i> <i>Eau</i>		✓	✓	✓
<b>Low water light</b> <i>Luz indicadora nivel de agua</i> <i>bajo</i> <i>Contrôle du niveau d'eau par voyant</i> <i>lumineux</i>			✓	✓
<b>Induction</b> <i>Inducción</i> <i>Induction</i>	✓			
<b>Capacity (L)</b> <i>Capacidad (L)</i> <i>Capacité (L)</i>	6,6 - 10,4	6,6 - 10,4	6,6 - 10,4	20
<b>Temperature control</b> <i>Control de temperatura</i> <i>Contrôle de température</i>	✓	✓	✓	✓

	<b>SOUP KETTLE</b> <i>OLLA ELÉCTRICA / MARMITE CHAUD</i>	<b>BAIN MARIE</b> <i>BAÑO MARÍA / BAIN MARIE</i>	<b>CHAFING DISH</b>
			
	✓	✓	✓
	400	1200	0
	✓	✓	✓
	10	20	9
	✓	✓	

EQUIPMENT  
MAQUINARIA  
EQUIPEMENT

EQUIPMENT  
MAQUINARIA  
EQUIPEMENT

# 12.4 Rethermalizers

Retermalizadores  
Appareil de remise en température

## INDUCTION 3D

REETHERMALIZER

MIRAGE®



**Low power, 3D induction, without the need to use water.**  
**Rapid heating time (50-60 min).**  
**Food does not need to be pre-heated.**  
**Directly from the freezer to the Rethermalizer.**  
**Pre-selection menu and precise temperature regulator.**

*Inducción 3D de bajo consumo, sin necesidad de utilizar agua.*  
*Tiempo de rethermalización rápido (50-60 min).*  
*Los alimentos no necesitan ser precalentados.*  
*Directamente del congelador al Retermalizador.*  
*Menú de preselección y regulador de temperatura preciso.*

Induction 3D basse consommation, sans nécessité d'utiliser de l'eau.  
Temps de rethermalisation rapide (50-60 min).  
Les aliments n'ont pas besoin d'être préchauffés.  
Directement du congélateur au rethermalisateur.  
Menu de présélection et régulateur de température précis.

# Rethermalizers 12.4

Retermalizadores  
Appareil de remise en température

**747-7411 Mirage® Induction Rethermalizers**  
*Retermalizador de inducción Mirage®*  
Appareil de remise en température à induction Mirage®

CE



**800 W**  
**3,5 A**  
**50/60Hz**



REF	L	Ø cm	H cm	Prof. cm	Volt. CA / AC	Plug Ench.	☐
7470210	6,6	30,3	34,2	17,6	230	EU	1
7470240	6,6	30,3	34,2	17,6	230	EU	1
7470310	6,6	30,3	34,2	17,6	230	UK	1
7470340	6,6	30,3	34,2	17,6	230	UK	1
74110210	10,4	35,3	34,2	17,6	230	EU	1
74110240	10,4	35,3	34,2	17,6	230	EU	1
74110310	10,4	35,3	34,2	17,6	230	UK	1
74110340	10,4	35,3	34,2	17,6	230	UK	1

**Natural / Naturel**  
 **Red / Rojo / Rouge**



**747D-7411D Mirage® Drop-In Induction encastrable**  
*Retermalizador de inducción Mirage® encastrable*  
Appareil de remise en température à induction encastrable Mirage®

1,8 m

CE



**800 W**  
**3,5 A**  
**50/60Hz**



REF	L	Ø cm	H cm	Prof. cm	Volt. CA / AC	Plug Ench.	☐
74702D	6,6	30,3	31,3	17,6	230	EU	1
74703D	6,6	30,3	31,3	17,6	230	UK	1
741102D	10,4	35,3	31,3	17,6	230	EU	1
741103D	10,4	35,3	31,3	17,6	230	UK	1

Drop-In / Encastr.



**88184 Induction ready inserts for Mirage® 3D Induction Rethermalizers**  
*Cubetas aptas para Retermalizadores Mirage® 3D*  
Conteneur pour Appareil de remise de température Mirage® 3D



REF	L	Fits opening Para abertura cm	Prof. cm	☐
88184	6,6	21,6	20,8	6
88204	10,4	26,7	20,8	6

**47488 Lid with hinge**  
*Tapa con visagra y orificio*  
Couvercle

CE



REF	For / Para	Ø cm	☐
47488	78184 / 88184	24,0	6
47490	78204 / 88204	28,7	6

## 12.4 Rethermalizers

Retermalizadores  
Appareil de remise en température

# Retro



Retro Rethermalizer unit heats products with water, like any bain marie. Heats food from a chilled state to a temperature in less than 90 minutes.

Ceramic base element ensures a fast start-up and consistent performance. Heavy duty exterior body ensures the unit remains cool to the touch while operating. Ladles sold separately.

El Retermalizador Retro calienta los productos con agua, como cualquier baño maría. Calienta la comida fría hasta una temperatura deseada en menos de 90 minutos.

El elemento de base cerámica garantiza un arranque rápido y un rendimiento uniforme. El cuerpo exterior no se calienta durante el uso del Retermalizador. Los cacillos se venden por separado.

L'unité de remise à température Retro chauffe les produits avec de l'eau, comme tout bain marie. Chauffe les aliments d'un état réfrigéré à une température en moins de 90 minutes.

L'élément de base en céramique garantit un démarrage rapide et une performance homogène. L'extérieur ultra-robuste garantit que l'appareil reste frais au toucher tout en fonctionnant.

## Rethermalizers 12.4

Retermalizadores  
Appareil de remise en température

**7217 Retro Stock Pot Kettle Rethermalizers**  
*Retermalizadores Estilo Retro*  
Marmite de remise en température Rétro

CE  
Retro

**Natural**  
Naturel

**Red**  
Rojo  
Rouge

**Blanc cassé**  
Blanco perla  
Pearl white

**Black**  
Negro  
Noir



REF	L	CA/AC Volt.	W	A	Plug Ench.	Hz	☐
7217810	6,6	230	1400	6,1	EU	50/60	1
7217910	6,6	230	1400	6,1	UK	50/60	1
7217850	6,6	230	1400	6,1	EU	50/60	1
7217950	6,6	230	1400	6,1	UK	50/60	1
7217855	6,6	230	1400	6,1	EU	50/60	1
7217955	6,6	230	1400	6,1	UK	50/60	1
7217860	6,6	230	1400	6,1	EU	50/60	1
7217960	6,6	230	1400	6,1	UK	50/60	1
7217310	10,4	230	1400	6,1	EU	50/60	1
7217410	10,4	230	1400	6,1	UK	50/60	1
7217350	10,4	230	1400	6,1	EU	50/60	1
7217450	10,4	230	1400	6,1	UK	50/60	1
7217355	10,4	230	1400	6,1	EU	50/60	1
7217455	10,4	230	1400	6,1	UK	50/60	1
7217360	10,4	230	1400	6,1	EU	50/60	1
7217460	10,4	230	1400	6,1	UK	50/60	1

**4980 One-Piece Ergo Grip™ Ladles with Kool-Touch® Handles**  
*Cacillos ErgoGrip™ de una sola pieza Kool-Touch®*  
Louches Ergo Grip™ monobloc avec manche Kool-Touch®



REF	ml	Bowl / Bol Ø cm	Total cm	*cm	☐
4980422	118,3	7,9	33,3	27,6	6
4980622	177,4	8,6	33,6	27,6	6

\*Length from bowl bottom to bend in handle  
\*Largo desde el fondo del porcionador hasta el gancho del asa  
\*Longueur du fond du bol à la courbure dans le manche

**One-piece construction.**  
Stainless steel.  
Plastic-coated handles are heat resistant to 82° C.

Construcción de una sola pieza en acero inoxidable.  
Asas revestidas de plástico que resisten el calor hasta 82 °C.

Construction monobloc Inox.  
Manches plastifiés résistant à 82 °C.

**46527 Lid with hinge**  
*Tapa con visagra y orificio*  
Couvercle

CE  
Retro



REF	Ø cm	☐
46527	24	6

**Bain Maries**  
*Baño maría*  
Bain-marie

**Thermoset Fiber-Reinforced Resin Well**  
Selfinsulating. Maximum energy efficiency. Easy to clean.

*Cuerpo de resina reforzada con fibra termofijada auto aislante. Máxima eficiencia energética. Fácil de limpiar.*

Compartiment en résine thermodurcie renforcée Isotherme. Rendement énergétique maximal. Nettoyage facile.

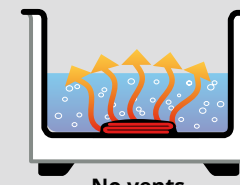

**No vents**  
*Sin ventilaciones*  
Sans ventilation

**High efficiency**  
*Alta eficiencia*  
Très écoénergétique

**DIRECT CONTACT HEATING SYSTEM - The ultimate in performance and efficiency**  
The heating element is in direct contact with the water for the most efficient heat transfer possible. This is coupled with Vollrath's exclusive Thermoset fiber-reinforced resin well, which provides superior insulation for maximum energy efficiency. So much heat is saved that there is no need for vents.

*SISTEMA DE CALENTAMIENTO DE CONTACTO DIRECTO - Lo último en rendimiento y eficiencia*  
*La resistencia está en contacto directo con el agua, transfiriendo el calor de una forma más eficiente. Esto se combina con el exclusivo cuerpo de resina reforzada, permitiendo un máximo aislamiento y máxima eficiencia energética. No necesita ventilación.*

**SYSTÈME DE CHAUFFAGE PAR CONTACT DIRECT - Performance et efficacité maximales**  
L'élément chauffant est en contact direct avec l'eau afin de permettre un transfert de la chaleur le plus efficace possible. De plus, le compartiment exclusif de Vollrath en résine thermodurcie renforcée offre une insolation supérieure rendant possible un rendement écoénergétique maximum. La conservation de chaleur est telle qu'il est inutile d'utiliser des évents.

**Upper rim designed to prevent drips and to drain off the moisture.**

*Borde superior diseñado para evitar goteos y drenar la humedad.*

Bordure supérieure conçue pour éviter l'égouttement et drainer l'humidité.

**Dome Heater. Uses up to 25% less energy. Non-stick surface prevents scale build-up for easy cleaning and longer operating life. Cast-in heating element for longer service life and greater energy transfer. Concentrates energy into the well – producing steam quickly.**

*Calentador con cúpula usa hasta un 25% menos de energía. La superficie antiadherente evita la acumulación de comida, facilitando la limpieza y prolongando la vida útil. Resistencia incrustada que alarga la vida útil y ayuda a difundir mejor el calor. Concentra la energía dentro del recipiente; produce vapor rápidamente.*

Élément chauffant avec dôme qui utilise jusqu'à 25 % d'énergie en moins La surface anti-adhésive empêche l'accumulation de dépôts calcaires pour faciliter le nettoyage et prolonger la durée de vie Élément chauffant moulé pour prolonger la durée de service et augmenter le transfert d'énergie Concentre l'énergie dans le compartiment ; produit rapidement de la vapeur.

**Capillary tube thermostat, provides energy only when it is required to reach the desired temperature.**

*Termostato de tubo capilar, suministra energía solamente cuando es necesario, para alcanzar la temperatura deseada.*

Thermostat à tube capillaire, il fournit de l'énergie que lorsque c'est nécessaire pour atteindre la température souhaitée.

**Non-skid Feet**

*Pies antideslizantes*  
Pieds antidérapants

**Increased Water Capacity. Reduce labor costs. Improve food quality by maintaining maximum moist heat.**

*Mayor capacidad de agua reducen los costes de mano de obra. Mejoran la calidad de la comida manteniendo el máximo calor húmedo.*

Capacité d'eau supérieure ayant pour conséquence une diminution des frais de main-d'oeuvre Amélioration de la qualité des aliments grâce au maintien d'un maximal de chaleur humide.

**Cooler Exterior Concentrates heat inside the well, not to the outside surface and rim.**

*Exterior más fresco concentra el calor dentro del receptáculo, no en la superficie exterior ni en el reborde.*

Extérieur plus frais qui concentre la chaleur à l'intérieur du compartiment et non sur la surface extérieure ou sur le rebord.

**Low positioning of electrical cord outlet adapts to the location of the power socket for safe installation. Allows the location to be controlled 360°. Standard cable length of 183 cm.**

*Cable eléctrico con salida inferior se adapta a la ubicación de la toma de corriente para una instalación segura. Permite controlar la ubicación en 360°. Largo estándar del cable de 183 cm.*

Câble d'alimentation muni d'une sortie située à la base S'adapte à la prise de courant pour une installation sûre. Permet le positionnement des commandes à 360 degrés. Câble d'une longueur standard de 183 cm.



EQUIPMENT  
MAQUINARIA  
EQUIPEMENT

EQUIPMENT  
MAQUINARIA  
EQUIPEMENT

# 12.4 Bain marie

Baños maría  
Bain-marie



## CAYENNE®

**72522 Cayenne® Heat'N'Serve Rethermalizer**  
*Olla Retermalizadora Cayenne® Heat'N'Serve*  
Ap. de remise en temp. Heat 'N Serve ronds Cayenne®

**800 W**  
**3,5 A**  
**230 V**



HS-11

REF	cm (Ø x H)	L	V	W	Plug Ench.	⊠
<b>72522</b>	32,0 x 24,5	10,4	230	800	EU	1

**With inset, hinged cover**  
*Con recipiente interior y tapa con visagra*  
Avec conteneur et couvercle

**47488 / 47490 Lid with hinge**  
*Tapa con visagra y orificio*  
Couvercle



**78204 Insert container**  
*Recipiente interior*  
Conteneur pour appareil de remise en température Heat 'N Serve ronds Cayenne®



REF	For / Para	Ø cm	AL cm	L	⊠
<b>78204</b>	72522	28,7	20,8	10,4	6

**\*Not induction-ready insert**  
*\*Cubeta no apta para Inducción*  
\*Conteneur non Induction

REF	For / Para	Ø cm	⊠
<b>47488</b>	78184 / 88184	24,0	6
<b>47490</b>	78204 / 88204	28,7	6

# Bain marie 12.4

Baños maría  
Bain-marie

**72630 Rethermalizer Cayenne® Heat'N'Serve**  
**72550 full size**  
*Retermalizador Cayenne® Heat'N'Serve*  
*1/1 Gastronorm*  
Appareils de remise en temp. Cayenne®  
Heat'N Serve 1/1 Gastronorme

**1.000 W**  
**4,3 A**  
**230 V**  
**50/60 Hz**



REF	Well depth / Profundidad cm	Plug / Ench.	⊠
<b>72630</b>	16,8	EU	1
<b>72550</b>	16,8	UK	1

**Thermoset fiber reinforced well — self-insulating with maximum energy efficiency. Capillary Tube Thermostat Control**

*Recipiente de resina reforzada con fibra termofijada aislante. Máxima eficiencia energética. Control de termostato*

Compartment en résine thermodurcie renforcée - isotherme pour un rendement énergétique maximal. Thermostat à tube capillaire



**P15020 Bain-marie 1/1 Gastronorm / Bain-marie**  
**1/1 Gastronorm with drain valve**  
*Baño maría 1/1 Gastronorm / Baño maría*  
*1/1 Gastronorm con grifo drenaje*  
Bain-marie 1/1 Gastronorme / Bain-marie  
1/1 Gastronorm avec robinet de drainage



**+30 °C**  
**+90 °C**

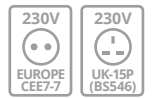

REF	TIPO / TYPE	V	W	Hz	⊠
<b>P15020</b>	A	230	1.200	50/60	1

**Without bags**  
*Sin cubetas*  
Sans bacs

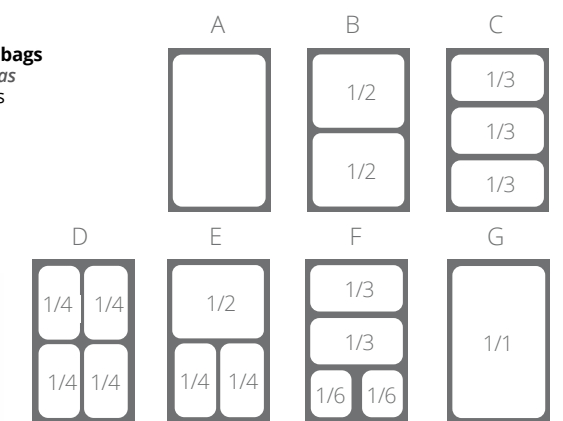

## 12.4 Bain marie

Baños maría  
Bain-marie

**P688130 Vacuum sealer**  
Envasadora al vacío  
Machine sous vide

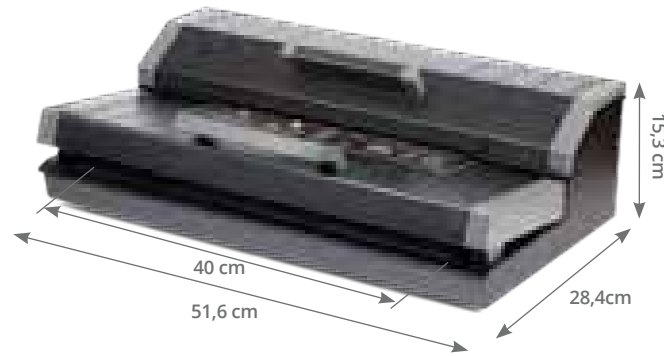

**Compact vacuum sealer.**

Food sealed under vacu-um can be preserved for much longer periods.

With the absence of oxygen, micro-organisms do not develop.

You can save time by cooking more than you need and keeping the excess in perfect condi-tion for later use.

- 400mm sealing width
- Vacuum function for table pans
- Marinated / Liquids function
- Partial vacuum function
- 20 L/min vacuum pump
- Possibility of using as bag sealer only

Envasadora al vacío compacta.

Los tiempos de conservación de los alimentos al vacío son mucho mayores.

Los microorganismos no se desarrollan ante la ausencia de oxígeno.

Puede ahorrar tiempo al cocinar en exceso y poder conservarlo en perfectas condiciones para un posterior uso.

- 400mm de banda de soldadura
- Función de vacío para cubetas
- Función marinado / Líquidos
- Función vacío parcial
- 20 L/min bomba vacío
- Posibilidad de usar solo como selladora de bolsas

Machine sous vide com-pacte.

Les durées de conserva-tion des aliments sous vide sont largement supérieures.

Les microorganismes ne se développent pas en raison de l'absence d'oxygène.

Vous pouvez gagner du temps en cuisinant en grande quantité que vous pouvez conserver dans de parfaites condi-tions pour une consom-mation ultérieure.

- Bande de soudure de 400 mm
- Fonction sous vide pour bacs
- Fonction marinade / Liquides
- Fonction sous vide partiel
- 20 L/min pompe à vide
- Peut s'utiliser comme scelleuse de sachets

REF	V	W	Hz	Kg	☐
<b>P688130</b>	230	200	50	7,5	1

**P688133 Vacuum bags**  
**P688134 Bolsas vacío**  
Sachets sous vide

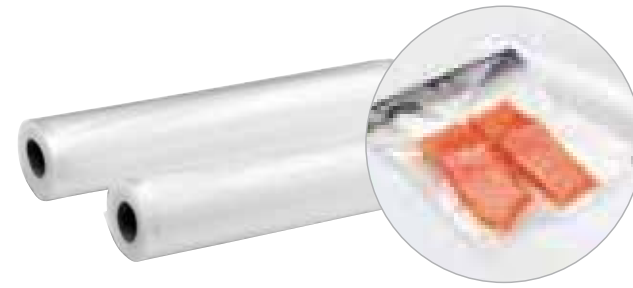

REF	L m	W cm	☐
<b>P688133</b>	6	30	1
<b>P688134</b>	6	40	1

**P910008 Soup kettle**  
Olla eléctrica para buffet  
Marmite buffet chaud



**External aluminium body with epoxy coating.**

Cuerpo de aluminio con baño epoxy.

Corps en aluminium laque epoxy.

REF	cm	L	☐
<b>P910008</b>	34,5 x 36	10,0	1

**Thermostat to regulate the temperature. Resistance 400 W, 1,9 amperes, 230 V single phase, 50/60 Hz. St/Steel lid. Inside pool St/Steel, 10 lts. capacity.**

Termostato regulador de temperatura. Resistencia 400 W, 1,9 amperios, 230 V monofase, 50/60 Hz. Tapa de acero inox. Cuba interior de acero inox. con capacidad para 10 litros.

Thermostat pour le réglage de la température. Résistance 400 W, 1,9 ampères, 230 V monophasée, 50/60 Hz. Couverture en acier inox. Cuve intérieure en acier inox. capacité 10 lts.

## Heating lamps 12.4

Lámparas mantenedoras  
Lampe chauffante

**P15029 Heat shade with lamp**  
**P15030 Lámpara mantenedora de comida caliente**  
Abat - jour pour lampe chauffante infra-rouge



REF	Ø cm	V	W	Hz	☐
<b>P15029</b>	23	230	250	50/60	1
<b>P15030</b>	23	230	250	50/60	1

**Rise&fall cable**  
Cable extensible  
Cable extensible

**Delivered with red bulb**  
Se entrega con bombilla roja  
Livraison avec ampoule rouge

**Aluminium or copper. With on/off switch. It gives instant direct heat. Provides a penetrating heat without congealing surfaces, gravies, etc. Simple to install. Delivered with bulb (250 W max). Cable with rise and fall mechanism (max. 140 cm).**

Aluminio o cobre. Con interruptor. Se pone en funcionamiento rápidamente y proporciona un calor penetrante sin solidificar la superficie de las salsas. Fácil de instalar. Se entrega con lámpara (250 W max). Versión con cable de mecanismo extensible (máx. 140 cm).

Aluminium ou cuivre. Avec interrupteur. Mise en service rapide. Chaleur pénétrante sans coaguler la surface des sauces, etc. Facile à installer. Livraison avec ampoule (250 W max). Avec cable extensible (max. 140 cm).

**P688265 Heat shade**  
**Lámpara mantenedora de comida caliente**  
Abat - jour pour lampe chauffante

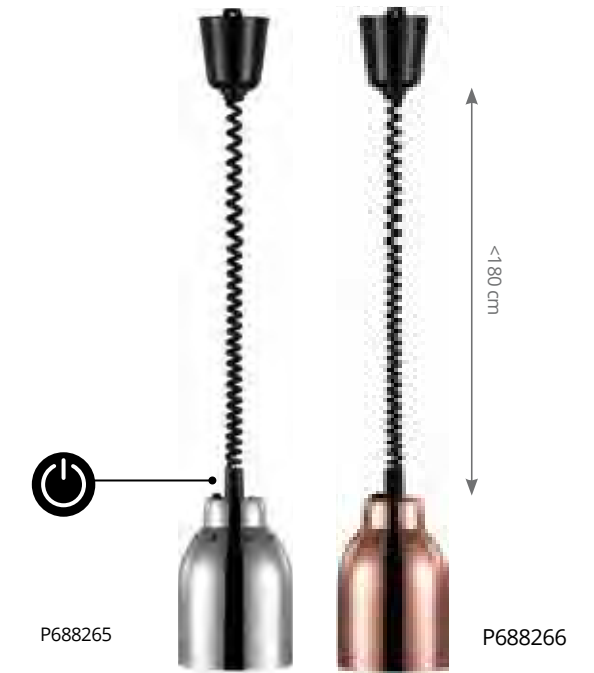

REF	Ø cm	V	W	Hz	☐
<b>P688265</b> St/Steel / Inox	16	230	250	50/60	1
<b>P688266</b> Copper / Cobre / Cuivre	16	230	250	50/60	1

**Bulb not included.**  
Bombilla no incluida.  
Ampoule non comprise.

**Cable with rise and fall mechanism upto 180 cm.**  
Cable extensible hasta 180 cm.  
Avec cable extensible jusqu'à 180 cm.

**P688045 Heat shade**  
**Lámpara mantenedora de comida caliente**  
Abat - jour pour lampe chauffante



**Aluminium with on/off switch. Delivered without bulb. Cable with rise and fall mechanism upto 180 cm.**

Aluminio. Con interruptor. Se entrega sin bombilla. Cable extensible hasta 180 cm.

Aluminium avec interrupteur. Livraison sans ampoule. Avec cable extensible jusqu'à 180 cm.

REF	Ø cm	V	W	Hz	☐
<b>P688045</b>	23	230	250	50/60	4

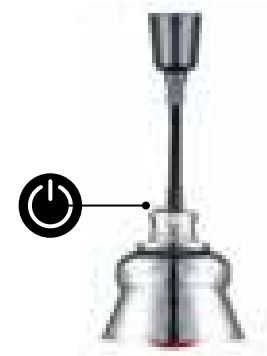

## 12.4 Heating lamps

Lámparas mantenedoras  
Lampe chauffante

**P688250 Heat shade**  
Lámpara mantenedora de comida caliente  
Abat - jour pour lampe chauffante



**Bulb not included.**  
Bombilla no incluida.  
Ampoule non comprise.

REF		Ø cm	V	W	Hz	☐
<b>P688250</b>	St/Steel / Inox	24	230	250	50/60	1
<b>P688251</b>	Copper / Cobre / Cuivre	24	230	250	50/60	1

**P508015 Heat shade with table support**  
Lámpara mantenimiento comida caliente  
con soporte mesa  
Lampe chauffante avec support



REF	W x D x H cm	V	W	Hz	☐
<b>P508015</b>	22 x 22 x 65	230	250	50/60	1

**Appliance adapted to heat and keep warm snacks and ready meals.**  
Structure is composed by an infrared lamp with a stainless steel base. Delivered with red bulb (250 W).

Lámpara adaptada para mantener caliente todos platos. Estructura compuesta de lámpara infrarrojos con base en acero inoxidable. Bombilla roja (250 W) incluida en el precio.

Lampe adaptée pour maintenir au chaud tous vos plats. Structure composée par lampe infrarouge avec base en inoxydable. Livrée avec ampoule rouge (250 W).

**P688260 Heat shade with marble**  
Lámpara mantenedora de comida caliente con mármol  
Abat - jour pour lampe chauffante avec marbre



**Bulb not included.**  
Bombilla no incluida.  
Ampoule non comprise.

REF		cm	V	W	Hz	☐
<b>P688260</b>	St/Steel / Inox	50 x 45	70	230	250	50/60
<b>P688261</b>	Copper / Cobre / Cuivre	50 x 45	70	230	250	50/60

**P15033 Bulb only**  
**P15034 Bombilla**  
Ampoule seule



REF	Color / Colour / Couleur	W	☐
<b>P15033</b>	red / rojo / rouge	175	1
<b>P710205</b>	red / rojo / rouge	250	1
<b>P15034</b>	white / blanco / blanc	175	1
<b>P710206</b>	white / blanco / blanc	250	1

## Heating lamps 12.4

Lámparas mantenedoras  
Lampe chauffante

**Contoured carving station**  
Estación buffet trinchante  
Station de découpage concave

**Attractive Carving Station with lamps for additional heat while serving.**  
On/off lighted switch on base.

Atractiva estación trinchante (para carnes) con lámparas calentadoras. Interruptor iluminado de encendido/apagado en la base.

Station de découpage attrayante disposant de lampes pour plus de chaleur durant le service. Interrupteur lumineux de marche/arrêt sur la base.

**2 x 175 W (Ref. P15033 / P15034)**

**Dual heat lamps.**  
Lámparas calentadoras dobles.  
Deux lampes chauffantes

**Spun aluminum shades for heat dissipation**  
Pantallas de aluminio para disipar el calor  
Abat-jour en aluminium repoussé pour dissiper la chaleur

**Clear tempered glass customer breath guard**  
Protección contra aliento con vidrio templado transparente  
Pare-haleine en verre trempé transparent

**Heavy-duty steel frame, chrome-plated**  
Marco de acero cromado altamente resistente  
Cadre en acier chromé extra-robuste

**Rubber feet provide stability and protect tabletop**  
Pies antideslizantes que ofrecen una mayor estabilidad  
Les pieds en caoutchouc stabilisent et protègent la table

**4667 Contoured Carving Station**  
Estación buffet trinchante  
Station de découpage concave



**Cord**  
Cable  
Cordon  
L: 1,8 m.

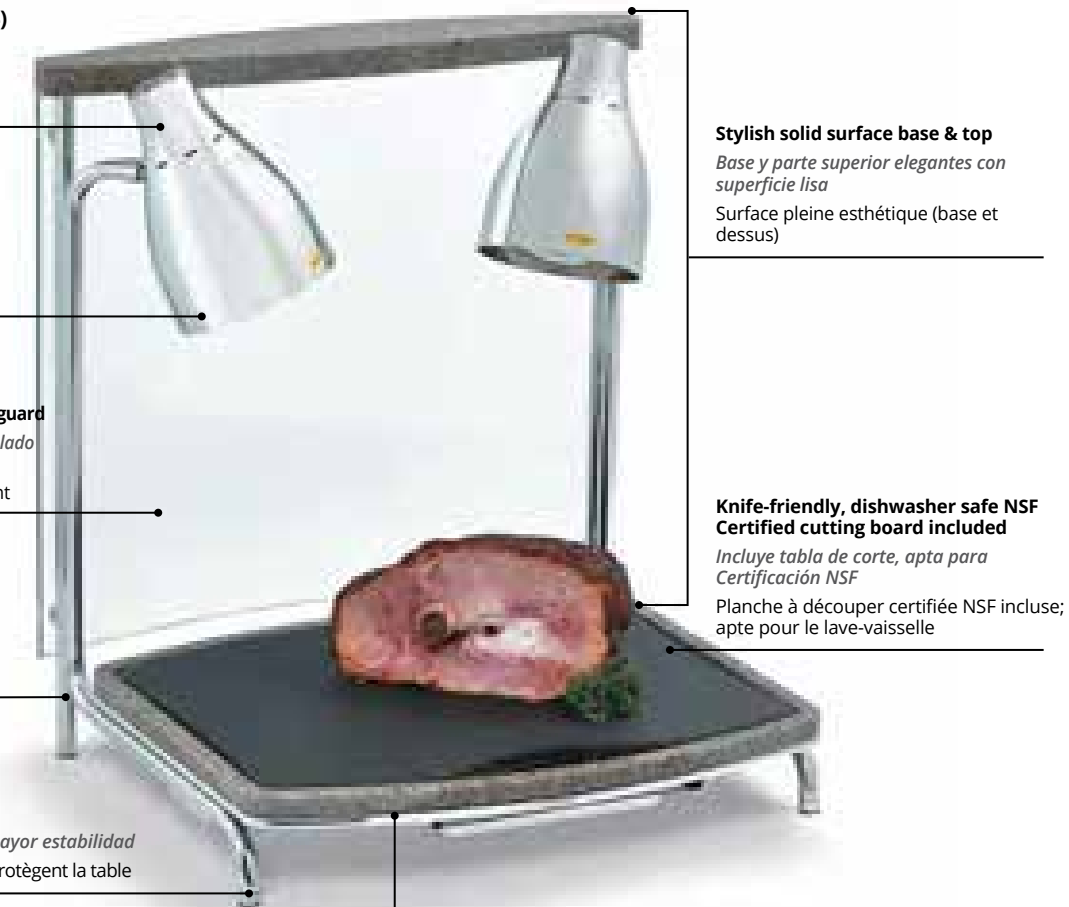

**Stylish solid surface base & top**  
Base y parte superior elegantes con superficie lisa  
Surface pleine esthétique (base et dessus)

**Knife-friendly, dishwasher safe NSF Certified cutting board included**  
Incluye tabla de corte, apta para Certificación NSF  
Planche à découper certifiée NSF incluse; apte pour le lave-vaisselle

**Recessed base channels liquids into removable drip pan**  
La base empotrada canaliza los líquidos hacia una cubeta para goteo retirable  
La base renforcée conduit les liquides dans un plateau ramasse-gouttes

REF	W x D x H cm	CA/AC Volt.	Plug Ench.	Hz	☐
<b>46671</b>	61 x 55,9 x 68,6	230	EU	50/60	1
<b>46672</b>	61 x 55,9 x 68,6	230	UK	50/60	1

**Infrared bulb**  
Bombilla de infrarrojos  
Ampoule infrarouge

**2 Infrared bulb included**  
Incluye 2 bombillas de infrarrojos  
Inclus 2 ampoules infrarouges

**P15033**



## 12.4 Warming equipment

Mantenedores de temperatura  
Maintenance de température

### P15073 Heating plate P15074 Placa caliente Plaque chauffante



18/10 St/Steel. Adjustable thermostat up to 75 °C. With on / off switch and indicator light.

Fabricada en acero inoxidable 18/10. Termostato regulable hasta 75 °C. Con interruptor central y piloto de control.

Habillage en inox 18/10. Thermostat réglable jusqu'à 75 °C. Interrupteur central et voyant de contrôle.

REF	cm	V	W	Hz	☐
P15073	60 x 40,0	230	600	50/60	1
P15074	53 x 32,5	230	600	50/60	1

### P15096 Chocolate fountain P15097 Fuente Fondue chocolate Fontaine à chocolat



REF	ml	Levels / Niveles / Niveaux	V	Hz	Ø cm	H cm	W	☐
P15096	700	3	230	50	21	38,0	250	1
P15097	1200	4	230	50	23	45,0	250	1

### 46110 Universal electric chafing heater Elemento eléctrico universal para chafing dish Résistance électrique pour chafers

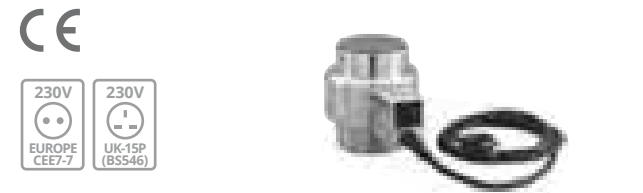

Sized to fit standard fuel opening.  
Dimensiones compatibles con el orificio para combustible estándar.  
Dimensions compatibles avec l'orifice pour combustible standard.

REF	For Para	V	W	A	Hz	Plug Ench.	☐
46110	EU	230	120/230	1.0	50/60	EU	1
46115	UK	230	120/230	1.0	50/60	UK	1

### P950000 Electric heating unit for chafing dish Elemento eléctrico para chafing dish Corps de chauffe pour chafing dish



REF	W	Hz	☐
P950000	240	50/60	1

### P15010 Chocolate warmer Baño maría chocolate Chauffe-chocolat



REF	Units / Unidades / Unités	Lts	V	W	Hz	☐
P15010	1	3,50	230	250	50/60	1

## Hot banquet trolleys 12.4

Armarios calientes  
Armoires chaudes

New range of heated trolleys for banquets and other catering events, a range that enables you to take the kitchen to customer, guaranteeing maximum quality and the delivery of dishes at temperatures above 65 °C.

Nueva gama de carros calientes para banquetes y catering, que le permitirán acercarse a la cocina allí donde esté el cliente, asegurando la máxima calidad y la entrega de los platos por encima de los 65 °C.

Nouvelle gamme de chariots chauds pour banquets et service traiteur (catering), pour vous permettre de rapprocher la cuisine du lieu où se trouve le client, en garantissant la qualité maximale et la livraison des plats au-dessus de 65 °C.

### EVEN CIRCULATION OF HOT AIR UNIFORMIDAD DE CIRCULACIÓN DEL AIRE CALIENTE UNIFORMITÉ CIRCULATION AIR CHAUD

The circulation of air is even and constant thanks to a unique system that makes it impossible for the containers to touch the cabinet base or sides.

Circulación uniforme y constante del aire gracias a un sistema único que imposibilita el contacto de las cubetas con el fondo o las paredes.

La circulation d'air chaud est uniforme et constant grâce à un système unique qui empêche que les bacs touchent le fond ou les parois.



### Rockwool insulation Aislamiento en lana de roca Isolation en laine de roche

**+LONG LASTING**  
Thermal insulation provided by rockwool preventing deformation through heat and lengthening the useful life of the cabinet.

**+ENERGY SAVING**  
Thanks to the extraordinary thermal insulation system, the desired temperature is achieved more quickly and the heat is conserved for longer periods.

**+HYGIENE**  
With the exclusive system of monoblock guides (without welds) cleanliness inside is grater, easier and faster.

**+ DURADERO**  
Aislamiento térmico en lana de roca evitando la deformación con el calor y ampliando la vida útil del armario.

**+ AHORRO ENERGÉTICO**  
Gracias al extraordinario sistema de aislamiento, se consigue el grado de temperatura deseado, con mayor rapidez y permite conservar el calor durante un período de tiempo más prolongado.

**+ HIGIÉNICO**  
Con el sistema de guías monobloc (sin soldaduras) la limpieza interior es mayor, más fácil y rápida.

**+DURABLE**  
Isolation thermique en laine de roche pour éviter la déformation par la chaleur et augmenter la vie utile de l'armoire.

**+HYGIÉNIQUE**  
Grâce au système exclusif de glissières monobloc (sans soudures) le nettoyage intérieur est plus parfait, plus aisé et plus rapide.

**+ÉCONOMIE D'ÉNERGIE**  
Grâce à l'extraordinaire système d'isolation thermique, la température souhaitée s'obtient plus rapidement et cela permet de conserver la chaleur pendant une plus longue période de temps.

# 12.4 Hot banquet trolleys

Armarios calientes  
Armoires chaudes

2

## CAPACITY / CAPACIDAD / CAPACITÉ

**Monoblock guides (without welds) for St/Steel trays and Gastronorm containers 2/1 and 1/1.**

Guías monobloc (sin soldaduras) para rejillas acero inoxidable y cubetas Gastronorm 2/1 y 1/1.

Glissières monobloc (sans soudures) pour grilles acier inoxydable et bacs Gastronorm 2/1 et 1/1.

## EASY HANDLING / FÁCIL MANEJO / MANIPULATION AISÉE

**Back side handles.**  
**Rotating wheels 360°.**  
**Front wheels with brakes**

Asas posteriores.  
Ruedas pivotantes & 360°.  
Dos con freno

Poignées postérieures.  
Roues pivotantes 360°.  
Roues avant avec freins

3

## HEAT BLOCK / BLOQUE CALÓRICO / BLOC CHAUFFANT

**Extractable without the need of tools. Thermostat for regulation of temperature 0 °C to 90 °C. Provided with humidification container.**

Extraíble sin necesidad de herramientas.  
Termostato regulador temperatura 0 °C a 90 °C. Recipiente humidificador integrado.

Amovible sans besoin d'outils. Thermostat régulateur de température 0 °C - 90 °C. Bac humidification intégré.

## P810

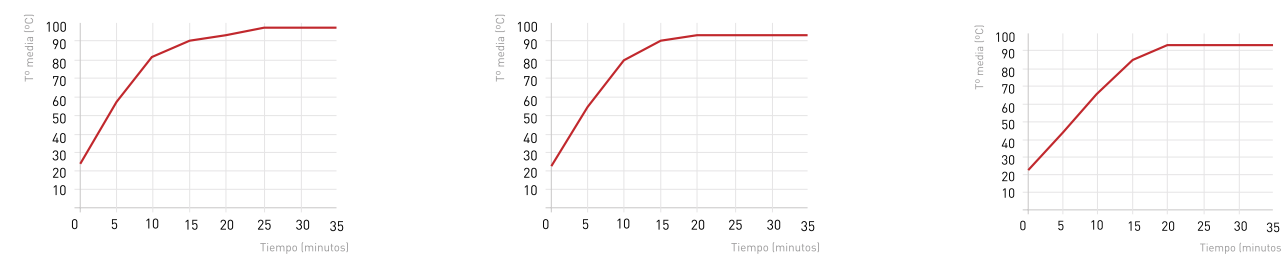

REF	Rails	Dimensions / Medidas	Guías / Glissières	Capacity / Capacidad / Capacité	W	V	Hz	⊞
P81000		GN 2/1		10 GN 2/1 - 20 GN 1/1	3.000	230 V II	50/60	1
P81010		GN 2/1		20 GN 2/1 - 40 GN 1/1	3.000	230 V II	50/60	1
P81020		GN 2/1		40 GN 2/1 - 80 GN 1/1	4.000	230 V II	50/60	1



# Hot banquet trolleys 12.4

Armarios calientes  
Armoires chaudes

## P15027 / P15028 Hot cupboards

Calentador de platos  
Chauffe - assiettes



+35 °C  
+85 °C



Inner sizes / Medidas interiores / Mesures interieures  
41 x 38 x 66,5 cm



Inner sizes / Medidas interiores / Mesures interieures  
70 x 35 x 80 cm

REF	Capacity plates / Capacidad platos / Capacité assiettes	V	W	Hz	⊞
P15027	60	230	750	50/60	1
P15028	120	230	1.250	50/60	1

**Hot cupboards. St/Steel, wholly insulated. With thermostat and switch with indicator light, removable and adjustable shelves. Door with heavy duty hinges. Diameter max. plates 32 cm.**

Calentadores de platos. Acero inoxidable, doble pared, completamente aislado térmicamente. Con termostato e interruptor con piloto de control. Estantes interiores regulables y extraíbles. Puertas con bisagras muy reforzadas. Diámetro máximo de los platos de 32 cm.

Chauffe-assiettes. Inox, double paroi, entièrement calorifugée, avec thermostat et interrupteur avec voyant de contrôle, étagères ajustables et amovibles. Porte avec charnières très résistantes. Diamètre max. assiettes 32 cm.

## 40862 Cubed-glass refrigerated display case

Vitrina de vidrio sobre encimera  
Vitrine en verre sur plan de travail.



NEW!



REF	W x D x H cm	V	A	Hz	Plug Ench.	⊞
40862	89,9 x 54 x 93,98	120	3,9	60	USA	1
40863	120 x 54 x 94	120	24,1	60	USA	1

- Digitally controlled thermostat on heated units for precise and consistent settings.
- Dual fans circulate air through unit to ensure even temperature control.
- Double-glaze front for added strength and insulation.

- Termostato con control digital par ajustes precisos y consistentes.
- Los ventiladores dobles permiten la circulación del aire por toda la unidad para garantizar un control uniforme de la temperatura.
- Frente de doble acristalamiento para mayor resistencia y aislamiento.

- Thermostat avec commande numérique pour des réglages précis et cohérents.
- Les doubles ventilateurs permettent la circulation de l'air dans toute l'unité pour assurer un contrôle uniforme de la température.
- Double vitrage pour plus de résistance et d'isolation.

**Ice-cream and beverage solutions**  
*Soluciones para la heladería*  
*Solutions pour glaciers*

## Soft ice-cream & frozen yogurt







*Helado soft y yogur helado*  
*Glace à l'italienne*



Stoelting offers commercial-grade gravity and pressure-fed Soft Serve Ice Cream, and Frozen Yogurt Machines in floor and countertop models. Whether you're looking for single flavor, twin twist, or double cylinder designs, we have the ideal equipment for your industry.

*Stoelting ofrece la posibilidad de comercializar helados suaves a través de una alimentación por gravedad y presión. Ofrece máquinas de yogur helado de sobremesa y para ubicar en suelo. Dispone de diseños de un solo sabor, doble tirador o doble cilindro; en definitiva, equipos ideales para la industria y servicio de helados y postres fríos.*

Stoelting offre la possibilità di commercializzare le gelato dolci attraverso un'alimentazione a gravità e pressione. Il propone delle macchine a yogurt glacé de table et à placer sur le sol. Il dispose de conceptions à une seule saveur, d'une poignée ou d'un double cylindre; en bref, un équipement idéal pour l'industrie et un service de crème glacée et de desserts froids.

Series Serie Série	111	131	231	411	431	144	421
							
<b>Power supply</b> <i>Alimentación</i> <i>Alimentation</i>	Gravity <i>Gravedad</i> <i>Gravité</i>	Gravity <i>Gravedad</i> <i>Gravité</i>	Gravity <i>Gravedad</i> <i>Gravité</i>	Pump <i>Bomba</i> <i>Pompe</i>	Pump <i>Bomba</i> <i>Pompe</i>	Gravity <i>Gravedad</i> <i>Gravité</i>	Pump <i>Bomba</i> <i>Pompe</i>
<b>Flavours</b> <i>Sabores</i> <i>Parfums</i>	1	2+1	2+1	1	2+1	Soft + Milshake	2
<b>Type</b> <i>Tipo</i> <i>Type</i>	Countertop <i>Sobremesa</i> <i>De comptoir</i>	Countertop <i>Sobremesa</i> <i>De comptoir</i>	Floor <i>Suelo</i> <i>Au sol</i>	Floor <i>Suelo</i> <i>Au sol</i>	Floor <i>Suelo</i> <i>Au sol</i>	Countertop <i>Sobremesa</i> <i>De comptoir</i>	Floor <i>Suelo</i> <i>Au sol</i>
<b>CONES CAPACITY</b> <i>CAPACIDAD CONOS</i> <i>CAPACITÉ CONES</i>							
<b>Model</b> <i>Modelo</i> <i>Model</i>	E						
	150-180	290-310	-	-	-		-
<b>Model</b> <i>Modelo</i> <i>Model</i>	F / SF						
	275-300	400-420	400-420	-	-	220-240	-
<b>Model</b> <i>Modelo</i> <i>Model</i>	O						
	380-420	-	780-820	-	675-700		675-700
<b>Model</b> <i>Modelo</i> <i>Model</i>	U						
	-	-	-	640-660	1.350-1.400		1.350-1.400

\*The production capacity may vary depending on the ambient temperature  
 \*La capacidad de producción puede variar en función de la temperatura ambiente utilizada  
 \*La capacité de production peut varier en fonction de la température ambiante au moment de l'utilisation

EQUIPMENT  
MÁQUINARIA  
EQUIPEMENT

# Shake & Smoothie freezers

Batidos & smoothies helados  
Frappés & smoothies glacés



Stoelting's Shake & Smoothie Freezers feature a compact design with high-capacity output. Our equipment will handle high-demand rush hour requirements quietly and efficiently, while giving your profits a boost. Ideally suited for high volume commercial operations, such as fast food locations, drivings, theme parks, institutions, and recreations facilities. Perfect for thin or thick milshakes, frozen beverages, smoothies and frozen cocktails.

Los congeladores Shake & Smoothie de Stoelting presentan un diseño compacto con salida de alta capacidad. Nuestros equipos controlan de manera silenciosa y eficiente los picos de alta demanda, lo que permite ahorrar a la hora que identificar los momentos de más demanda. Ideal para operaciones comerciales de gran volumen en servicios, tales como cadenas de comida rápida, autocines, parques temáticos, instituciones e instalaciones recreativas. Perfecto para batidos finos o espesos, bebidas congeladas, batidos y cócteles congelados.

Les congélateurs Shake & Smoothie de Stoelting présentent un design compact avec une sortie de haute qualité. Nos équipes contrôlent silencieusement et efficacement les pics de demande, ce qui permet d'économiser en identifiant les moments les plus demandés. Idéal pour les opérations commerciales de grands volumes dans les services tels que les chaînes de restauration rapide, les cinémas automatiques, les parcs à thème, les institutions et les installations de loisirs. Parfait pour les smoothies fins ou épais, les boissons surgelées et les cocktails surgelés.

Series Serie Série	112	122	O212	SU412
<b>Power supply</b> Alimentación Alimentation	Gravity Gravedad Gravité	Gravity Gravedad Gravité	Gravity Gravedad Gravité	Gravity Gravedad Gravité
<b>Flavours</b> Sabores Parfums	1	2	1	1
<b>Type</b> Tipo Type	Countertop Sobremesa De comptoir	Countertop Sobremesa De comptoir	Floor Suelo Au sol	Floor Suelo Au sol
<b>LITRES/HOUR</b> LITROS/HORA LITRES/HOUR				
<b>Model</b> Modelo Model	E 45-68	90-136	-	-
<b>Model</b> Modelo Model	F 68-91	136-182	-	-
<b>Model</b> Modelo Model	SO -	-	98	-
<b>Model</b> Modelo Model	SU -	-	-	114

# Frozen custard

Heladora custard  
Glaces custard



Stoelting Frozen Custard Continuous Flow Freezer Machines have become the standard in the industry for quality and durability. With our Quick-Freeze Technology TM, the barrel freezes custard mix faster than any other machine. This minimizes the size of the ice crystals and ensures the smoothest, creamiest product.

Las máquinas congeladoras de flujo continuo se han convertido en el estándar en la industria de calidad y durabilidad. Con nuestra tecnología TM de congelación rápida, el barril congela la mezcla de crema pastelera de forma más rápida que cualquier otra máquina del mercado. Esto minimiza el tamaño de los cristales de hielo y asegura la consecución de un producto más suave y cremoso.

Les congélateurs à flux continu sont devenus la norme dans l'industrie en matière de qualité et de durabilité. Avec notre technologie de congélation rapide TM, le baril gèle le mélange de crème pâtissière plus rapidement que n'importe quelle autre machine sur le marché. Cela minimise la taille des cristaux de glace

Series Serie Série	101	202	303
<b>Power supply</b> Alimentación Alimentation	Gravity Gravedad Gravité	Gravity Gravedad Gravité	Gravity Gravedad Gravité
<b>Flavours</b> Sabores Parfums	1	2	3
<b>Type</b> Tipo Type	Countertop Sobremesa De comptoir	Floor Suelo Au sol	Floor Suelo Au sol
<b>LITRES/HOUR</b> LITROS/HORA LITRES/HOUR			
<b>Model</b> Modelo Model	CF 19-23	-	-
<b>Model</b> Modelo Model	M -	26-38	-
<b>Model</b> Modelo Model	CC -	42-53	42-53

EQUIPMENT  
MAQUINARIA  
EQUIPEMENT

EQUIPMENT  
MAQUINARIA  
EQUIPEMENT

# Batch equipment

Mantecadoras  
Turbines à glace



**Rugged, reliable batch freezers for Premium Ice Cream, Gelato, Sherbet, Sorbet, and Water Ices. Our Batch Ice Cream Machines are simple to operate, easy to maintain, and built to assure perfect frozen desserts every time.**

*Congeladores por lotes resistentes y confiables para helados, gelato, sorbete y helados de agua premium. Nuestras máquinas de helados por lotes son fáciles de operar, fáciles de mantener y construidas para asegurar postres congelados perfectos en todo momento.*

Congélateurs laitiers robustes et fiables pour la crème glacée, le sorbet et la crème glacée premium. Les machines à crème glacée par lots sont faciles à utiliser, faciles à entretenir et construites pour assurer des desserts congelés parfaits à tout moment.

Series Serie Série	<b>VB1</b>	<b>VB9</b>	<b>VB25</b>
<b>Power supply</b> Alimentación Alimentation	<b>Gravity</b> Gravedad Gravité	<b>Gravity</b> Gravedad Gravité	<b>Gravity</b> Gravedad Gravité
<b>Type</b> Tipo Type	<b>Countertop</b> Sobremesa De comptoir	<b>Countertop</b> Sobremesa De comptoir	<b>Floor</b> Suelo Au sol
<b>CAPACITY L/H</b>	9-10	9-10	20
<b>Work Cycle (min)</b> Ciclo trabajo (min) Cycle de travail (min)	14-18	14-18	12-15

# Accesorios

Accesorios  
Accessoires



**Stoelting also offers accessories for our freezers, such as remote mix pumps to keep mix handling to a minimum, floor stands for converting counter top units to floor models, and mix-in blenders for marvelous mix-ins.**

*Stoelting también ofrece accesorios para nuestros congeladores, tales como bombas de mezcla remotas para mantener el manejo de mezclas al mínimo, soportes de suelo para convertir unidades de sobremesa en modelos de suelo y licuadoras mezclables para conseguir las mejores mezclas.*

Stoelting offre également des accessoires pour nos congélateurs, tels que des pompes de mélange à distance pour maintenir la manipulation des mélanges au même niveau, des supports de sol pour convertir les unités de bureau en modèles de sol et des mixeurs pour obtenir de meilleurs résultats.

Series Serie Série	<b>Mixing blender</b>	<b>CW5</b>	<b>CW2</b>
<b>Power supply</b> Control Alimentation			
<b>Model 521030</b>	<b>Foot Switch</b>	-	-
<b>Model 521035</b>	<b>Mounted Speed Control</b>	-	-
<b>Revolution per minut</b> RPM Type	0-3000	-	-
<b>Capacity</b> Capacidad (L) Capacité	-	5	2

EQUIPMENT  
MAQUINARIA  
EQUIPEMENT

EQUIPMENT  
MAQUINARIA  
EQUIPEMENT

# Cold & frozen Beverage dispensers

Bebidas frías y granizadas  
Boissons froides et granités

Stoelting manufactures a wide variety of commercial grade frozen beverage dispensing equipment. These compact and ultra high capacity units are perfect for a variety of high margin specialty drinks, smoothies, juices and frozen slush drinks including granitas, cappuccinos and frozen cocktails.

Stoelting fabrica una amplia variedad de equipos dispensadores de bebidas congeladas de grado comercial. Estas unidades compactas y de ultra alta capacidad son perfectas para una variedad de bebidas especiales de alto margen, batidos, zumos y bebidas congeladas, incluyendo granizados, capuchinos y cócteles congelados.

Stoelting fabrique une grande variété d'équipements de distribution de boissons congelées de qualité commerciale. Ces unités compactes et ultra-haute capacité sont parfaites pour une variété de boissons spéciales à marge élevée, de smoothies, de jus et de boissons surgelées, y compris les granités, les cappuccinos et les cocktails surgelés.

## VCBF

Series Serie Série	118-37	D118-37	128	168
				
Power supply Alimentación Alimentation	Gravity Gravedad Gravité	Gravity Gravedad Gravité	Gravity Gravedad Gravité	Gravity Gravedad Gravité
Flavours Sabores Parfums	1	1	2	3
Type Tipo Type	Countertop Sobremesa De comptoir	Countertop Sobremesa De comptoir	Countertop Sobremesa De comptoir	Countertop Sobremesa De comptoir
Capacity per bowl Capacidad por bol (L) Capacité par bol	10	18,93	10	10
BTU/Hr	1100	8000	2550	3630

## VCBA

118-37	A118	128	168	257
				
Gravity Gravedad Gravité	Gravity Gravedad Gravité	Gravity Gravedad Gravité	Gravity Gravedad Gravité	Gravity Gravedad Gravité
1	1	2	3	1
Countertop Sobremesa De comptoir	Countertop Sobremesa De comptoir	Countertop Sobremesa De comptoir	Countertop Sobremesa De comptoir	Floor Suelo Au sol
6	7,57	6	6	37,85
830	4500	1900	2550	2600

\*Check with your salesteam for larger capacity machines.

\*Consulta con tu comercial para máquinas de mayor capacidad

\*Consultez votre commercial pour les machines de plus grande capacité

# 13 Melamine

Melamina y presentación  
Melamine et présentation



	<b>VOLCANO</b>	334
	<b>STONEHENGE</b>	335
	<b>SIENA</b>	336
	<b>BIANCA</b>	337
	<b>SAHARA</b>	338
	<b>MOON</b>	339
	<b>BUFFET DISPLAY</b>	340
	<b>HIDRAULICA</b>	341
	<b>WOOD</b>	342

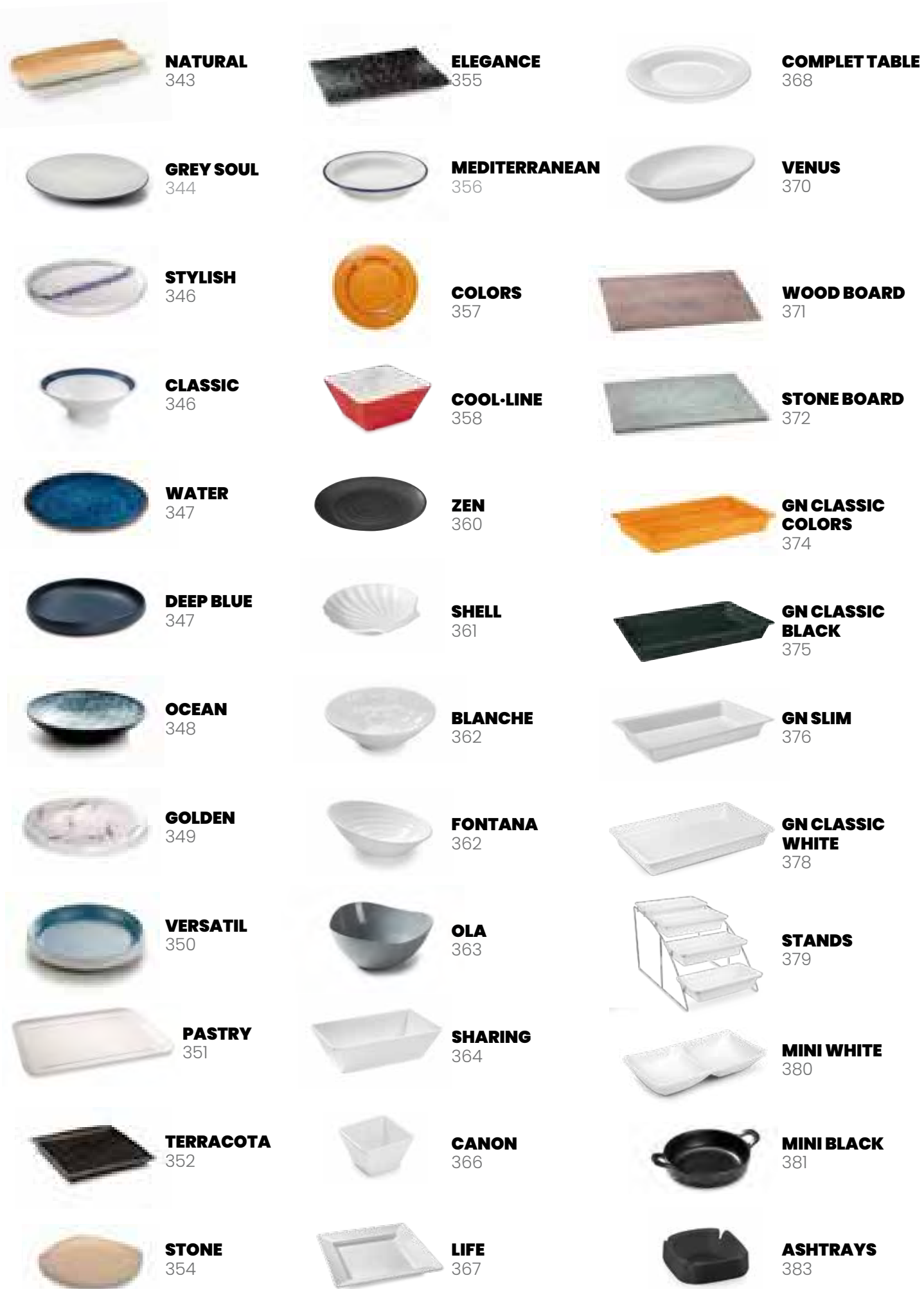

It is highly recommended for table & buffet service for its properties.

Es un material muy utilizado en el servicio de mesa y presentación por sus propiedades.

Très utilisée dans le service de table et buffet par ses propriétés.



Melamine is a synthetic resin which becomes harden and Formed after heating

La melamina es una resina sintética que se endurece y toma forma después de un proceso de calentamiento

La mélamine est une résine Synthétique qui se durcit et prend-forme après un processus spécial de Chauffage

### MAIN FEATURES CARACTERÍSTICAS PRINCIPALES CARACTÉRISTIQUES

**SGS** Food contact approved: certified by SGS  
Contacto con alimentos: certificado por SGS  
Contact avec aliments: certifié par SGS

**+70°C**  
**-20°C** Withstands temperatures: -20°C & +70°C  
Condiciones de trabajo: entre -20°C y +70°C  
Températures entre: -20°C et +70°C

### USES USOS USAGES

**Not recommended: Microwave**  
No recomendada: Microondas  
Non recommandée: Micro-ondes

**Not recommended: Oven**  
No recomendada: Horno  
Non recommandée: Four

**Not recommended: Direct flame**  
No recomendada: Directo al fuego  
Non recommandée: Direct au feu

**Not recommended: Oil and chemical products**  
No recomendada: Aceite y productos químicos  
Non recommandée: Huile ou produits chimiques

### PROPERTIES PROPIEDADES PROPRIÉTÉS

**Heat resistant**  
Resistente al calor  
Résistante à la chaleur

**Corrosion resistant**  
Resistente a la corrosión  
Résistante à la corrosion

**Non-toxic**  
No tóxico  
Non-toxique

**Non-odorous**  
Inodoro  
Inodore

**Light weight**  
Ligero  
Légère

**Free form deformation**  
Indeformable  
Indéformable

**Low heat conductivity**  
Poco conductor del calor  
Baisse conductivité de la chaleur

MELAMINE  
MELAMINA  
MÉLAMINE

MELAMINE  
MELAMINA  
MÉLAMINE



# 13 Volcano



**NEW!**

**P22377** Plate  
Plato  
Assiette



REF		Ø cm	H cm	
P22377		23	2,0	12
P22378		26	2,2	12
P22386		23	2,0	12
P22387		26	2,2	12

**P22379** Bowl  
Bol  
Bol



REF		Ø cm	H cm	
P22379		14	3,5	12
P22380		18	4,5	12
P22388		14	3,5	12
P22389		18	4,5	12

**P22381** Deep plate  
Plato hondo  
Assiette creuse



REF		Ø cm	H cm	
P22381		25	5,7	6
P22390		25	5,7	6

**P22382** Plate  
Plato  
Assiette



REF		Ø cm	H cm	
P22382		15,2	2,7	6
P22384		21,5	3,1	6
P22385		24,0	3,4	4
P22391		15,2	2,7	6
P22393		21,5	3,1	6
P22394		24,0	3,4	4

# Stonehenge 13



**NEW!**

**P22409** Rectangular tray  
Bandeja rectangular  
Plateau rectangulaire



REF		W x D x H cm	
P22409		39,1 x 16,5 x 3,2	1

**P22410** Oval plate  
Plato ovalado  
Assiette ovale



REF		W x D x H cm	
P22410		24,1 x 17,2 x 3,5	1

**P22411** Display tray  
Bandeja presentación  
Plateau de présentation



REF		W x D x H cm	
P22411		54 x 27 x 2	1

**P22412** Rectangular tray  
Bandeja rectangular  
Plateau rectangulaire



REF		W x D x H cm	
P22412		40 x 30 x 2,15	1



**NEW!**

**P22413** Gray plate  
Plato gris  
Assiette grise



REF	Ø cm	H cm	
P22413	22	1,5	1
P22414	27	1,6	1

**P22415** Blue plate  
Plato azul  
Assiette bleue



REF	Ø cm	H cm	
P22415	22	1,5	1
P22416	27	1,6	1

**P22417** White plate  
Plato blanco  
Assiette blanche



REF	Ø cm	H cm	
P22417	22	1,5	1
P22418	27	1,6	1

See products on **P. 357**  
Ver productos en / Voir produits en page



**NEW!**

**P22368** Ripple ramekin  
Ramekin ondulado  
Ramequin ondulé



REF	cm	H cm	ml	
P22368	Ø 6,2	3,5	60	48

**P22369** Ripple ramekin  
Ramekin ondulado  
Ramequin ondulé



REF	cm	H cm	ml	
P22369	Ø 7,8	4,3	120	48

**P22370** Ripple serving bowl  
Bol ondulado  
Bol ondulé



REF	cm	H cm	
P22370	Ø 14	9	12

**P22371** Ripple serving bowl  
Bol ondulado  
Bol ondulé



REF	cm	H cm	
P22371	Ø 20	7	12

**P22372** Ripple serving bowl  
Bol ondulado  
Bol ondulé



REF	cm	H cm	
P22372	Ø 25	15	6



**NEW!**

**P22404** Oval plate  
*Plato ovalado*  
Assiette ovale



REF	W x D x H cm	
P22404	21,5 x 11 x 4,5	12

**P22405** Oval bowl  
*Bol ovalado*  
Bol ovale



REF	W x D x H cm	
P22405	16,5 x 10 x 5,7	12
P22406	20 x 15,5 x 10	12
P22407	26 x 16 x 13,3	6

**P22408** Oval bowl  
*Bol ovalado*  
Bol ovale



REF	W x D x H cm	
P22408	32,5 x 26,5 x 18	3



**NEW!**

**P22399** Round bowl  
*Bol redondo*  
Bol rond



REF	Ø cm	H cm	
P22399	22,5	7	3
P22400	29,0	10	3

**P22401** Round bowl  
*Bol redondo*  
Bol rond



REF	Ø cm	H cm	
P22401	34,5	7	3

**P22402** Buffet display  
*Expositor buffet*  
Présentoir buffet



Compatible with  
*Compatible con* P22399, P22400 y P22401  
*Compatible avec*

REF	Ø cm	H cm	
P22402	16,5	10	6
P22403	16,5	18	6



Fitting system with the base  
that provides stability

*Sistema de encaje con la base  
que aporta estabilidad*

*Système d'assemblage avec la  
base qui assure la stabilité*

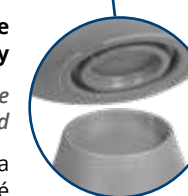

# 13 Buffet display

Expositor buffet  
Présentoir buffet



Me  
Melamine

**NEW!**

**P22338** Buffet display  
Expositor buffet  
Présentoir buffet



Compatible with  
Compatible con **P22361 P22362 y P22363**  
Compatible avec

REF	Ø cm	H cm	
P22366	16,5	10	6
P22367	16,5	18	6

**P22338** Display tray  
Bandeja presentación  
Plateau présentation



REF	Ø cm	H cm	
P22361	22,7	1,5	1
P22362	27,8	1,5	1
P22363	32,7	1,5	1

The three pieces are sold separately  
Las tres piezas se venden por separado  
Les trois pièces sont vendues séparément

See products on **P. 395**  
Ver productos en / Voir produits en page

**Dome cover**  
Tapa campana  
Couvercle cloche



Fitting system with the base that provides stability  
Sistema de encaje con la base que aporta estabilidad  
Système d'assemblage avec la base qui assure la stabilité

# Hidraulica 13



Me  
Melamine

**NEW!**

**P22373** Display tray 1/1  
Bandeja presentación 1/1  
Plateau présentation 1/1



REF	GN	W x D x H cm	
P22373	1/1	53 x 32,5 x 1,8	1

**P22374** Display tray 1/2  
Bandeja presentación 1/2  
Plateau présentation 1/2



REF	GN	W x D x H cm	
P22374	1/2	32,5 x 26,5 x 1,8	1

**P22375** Display tray 1/3  
Bandeja presentación 1/3  
Plateau présentation 1/3



REF	GN	W x D x H cm	
P22375	1/3	32,5 x 17,6 x 1,8	1

**P22376** Display tray 2/4  
Bandeja presentación 2/4  
Plateau présentation 2/4



REF	GN	W x D x H cm	
P22376	2/4	53 x 16,2 x 1,8	1

See products on **P. 397**  
Ver productos en / Voir produits en page

**Clear GN lids for presentation**  
Tapas GN transparentes presentación  
Couvercles GN transparentes de présentation



# 13 Wood



Me  
Melamine

**NEW!**

**P22424** Serving board  
Tabla presentación  
Table de présentation

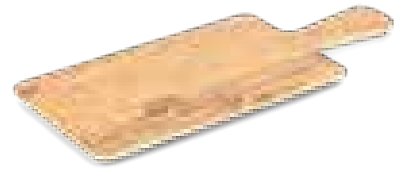

REF	W x D x H cm	
P22424	37,5 x 14 x 1,5	1

**P22426** Serving board  
Tabla presentación  
Table de présentation

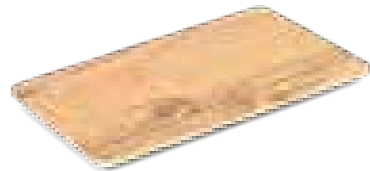

REF	W x D x H cm	
P22426	28 x 15,5 x 1,5	1

**P22127** Display plate  
Soporte presentación  
Présentoir



REF	Ø cm	H cm	
P22127	23,0	1,5	1
P22128	28,0	1,5	1
P22129	32,5	1,5	1

**P22425** Serving board  
Tabla presentación  
Table de présentation



REF	W x D x H cm	
P22425	42 x 18 x 1,6	1

**P22427** Serving board  
Tabla presentación  
Table de présentation

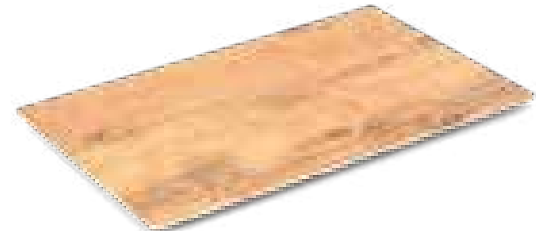

REF	W x D x H cm	
P22427	40,5 x 25,5 x 1,55	1

**P2265** Oven oak peel  
Pala horno roble  
Pelle four chêne



REF	cm	
P22650	Ø 30	6
P22651	53 x 20	6
P22652	61 x 20	6

# Natural 13



Me  
Melamine

**P22324** Rectangular tray  
Bandeja rectangular  
Plateau rectangulaire



REF	W x D x H cm	GN	
P22324	32,5 x 26,5 x 4	1/2	1
P22328	32,5 x 26,5 x 4	1/2	1

**P22323** Rectangular tray  
Bandeja rectangular  
Plateau rectangulaire



REF	W x D x H cm	GN	
P22323	32,5 x 17,6 x 4	1/3	1
P22327	32,5 x 17,6 x 4	1/3	1

**P22322** Rectangular tray  
Bandeja rectangular  
Plateau rectangulaire



REF	W x D x H cm	GN	
P22322	53 x 16,5 x 4	2/4	1
P22326	53 x 16,5 x 4	2/4	1

**P22325** Leaf plate  
Bandeja forma hoja  
Plateau forme feuille



REF	W x D x H cm	
P22325	37,5 x 15 x 2	1

MELAMINE  
MELAMINA  
MELAMINE

MELAMINE  
MELAMINA  
MELAMINE

# 13 Grey Soul



Me  
Melamine

**P22888** Square plate  
*Plato cuadrado*  
Assiette carrée



REF	W x D x H cm	
P22888	15 x 15 x 2,00	1
P22889	18 x 18 x 2,00	1
P22891	21 x 21 x 2,05	1

**P22893** Rectangular tray  
*Bandeja rectangular*  
Plateau rectangulaire



REF	W x D x H cm	
P22893	21,6 x 11 x 2,5	1
P22894	29 x 11 x 2,5	1

**P22896** Snacks or sauce tray  
*Bandeja snacks o salsas*  
Plateaux sauces



REF	W x D x H cm	
P22896	6,5 x 6,5 x 2,8	1
P22897	11,5 x 6,5 x 2,8	1

**P22892** Triangular plate  
*Plato triangular*  
Assiette triangulaire



REF	W x D x H cm	
P22892	20 x 20 x 6,8	1

**P22898** Slanted round bowl  
*Bol redondo inclinado*  
Bol rond incliné



REF	Ø cm	H cm	
P22898	14,5	10,5	1
P22899	17,5	12,2	1

**P22308** Tapas dish  
*Plato tapas*  
Plat à tapas



REF	Ø cm	H cm	
P22308	14,0	2,5	1
P22309	16,5	2,8	1

# Grey Soul 13

Me  
Melamine

**P22306** Plate  
*Plato*  
Assiete



REF	Ø cm	H cm	
P22306	19,0	2,0	1
P22307	21,5	2,5	1

**P22303** Round bowl  
*Bol redondo*  
Bol rond



REF	Ø cm	H cm	
P22303	14,5	5,5	1
P22304	24,0	6,0	1

**P22895** Round bowl  
*Bol redondo*  
Bol rond



REF	Ø cm	H cm	
P22895	11	4,5	1

**P22422** Rectangular plate  
*Plato rectangular*  
Assiette rectangulaire



REF	W x D x H cm	
P22422	32,7 x 9 x 5,8	1

**P22305** Conical bowl  
*Bol cónico*  
Bol conique



REF	Ø cm	H cm	
P22305	12	6,5	1

**P22301** Oval serving dish  
*Fuente oval*  
Plat ovale



REF	W x D x H cm	
P22301	29,5 x 18 x 3,5	1
P22302	34,5 x 22 x 4	1

**P22423** Oval plate  
*Plato ovalado*  
Assiette ovale



REF	W x D x H cm	
P22423	34,5 x 10,3 x 6 cm	1

## 13 Stylish



**P22333** Plate  
Plato  
Assiette



REF	Ø cm	H cm	
P22333	20	2,0	1
P22334	27	2,5	1
P22335	31	3,0	1

## Water 13



**P22318** Plate  
Plato  
Assiette



REF	Ø cm	H cm	
P22318	25,0	1,5	1
P22319	27,5	1,5	1
P22320	30,0	1,5	1

**P22321** Deep dish  
Plato hondo  
Assiette creuse



REF	W x D x H cm	
P22321	23 x 17,5 x 6,5	1

## Classic

**P22329** Conical bowl  
Bol cónico  
Bol conique



REF	Ø cm	H cm	
P22329	17	6	1
P22330	22	8	1
P22331	25	9	1

## Deep Blue

**P22332** Serving plate  
Plato presentación  
Assiette présentation



REF	W x D x H cm	
P22332	30 x 28,5 x 4,5	1



**P22316** Round bowl  
Bol redondo  
Bol rond



REF	Ø cm	H cm	
P22316	17	5	1

**P22317** Deep dish  
Plato hondo  
Assiette creuse



REF	Ø cm	H cm	
P22317	22,5	5	1

**P22314** Plate  
Plato  
Assiete

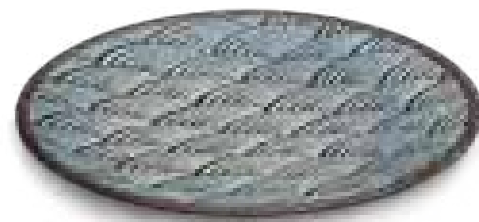

REF	Ø cm	H cm	
P22314	22	2	1
P22315	27	2	1

**P22313** Rectangular tray  
Bandeja rectangular  
Plateau rectangulaire



REF	cm	H cm	GN	
P22313	53,0 x 32,5	2	1/1	1
P22312	32,5 x 26,5	2	1/2	1
P22310	32,5 x 17,6	2	1/3	1
P22311	53,0 x 16,5	2	2/4	1



**P22344** Plate  
Plato  
Assiete



REF	Ø cm	H cm	
P22344	23,0	3,0	1
P22345	27,5	3,5	1
P22346	32,0	4,0	1

**P22347** Serving plate  
Plato presentación  
Assiette présentation



REF	W x D x H cm	
P22347	29 x 26,5 x 1,5	1

**P22886** Serving plate  
Plato presentación  
Assiette présentation



REF	W x D x H cm	
P22886	25,9 x 16,7 x 2	1

**P22348** Oval serving dish  
Fuente oval  
Plat ovale



REF	W x D x H cm	
P22348	30,5 x 11 x 3	1
P22884	35,5 x 12,8 x 3	1
P22885	40,6 x 14,7 x 3	1

**P22887** Plate 2 compartments  
Plato 2 compartimentos  
Assiette 2 compartiments



REF	W x D x H cm	
P22887	28,4 x 11 x 2,5	1



# 13 Versatil



**P22339** Tapas dish  
Plato tapas  
Plat à tapas



REF	W x D x H cm	
P22339	13 x 15,5 x 4	1
P22341	15 x 15 x 2,5	1

**P22336** Deep dish  
Plato hondo  
Assiette creuse



REF	Ø cm	H cm	
P22336	25,5	5,5	1

**P22342** Rectangular tray  
Bandeja rectangular  
Plateau rectangulaire

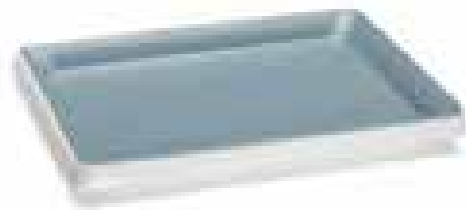

**P22340** Plate  
Plato  
Assiete



REF	Ø cm	H cm	
P22340	19,5	3	1

**P22337** Oval serving dish  
Fuente oval  
Plat ovale



REF	W x D x H cm	
P22337	23 x 16,5 x 3	1
P22338	28 x 20 x 3	1

REF	W x D x H cm	
P22342	31,5 x 23 x 3	1
P22343	33,5 x 13 x 3	1

# Pastry 13



**P23990** Display tray  
Bandeja presentación  
Plateau présentation



REF	Mod	L mm	H cm	
P23990	1/1	530 x 325	1,8	12
P23991	1/2	325 x 265	1,8	24
P23992	1/3	325 x 176	1,8	36
P23993	2/4	530 x 162	1,8	24

**P22775** Confectionery tray  
Bandeja repostería  
Plateau à pâtisserie



REF	H cm	cm	H cm	
P22775	2	36,5 x 29,5	2	1
P22778	2	36,5 x 29,5	2	1
P22779	2	36,5 x 29,5	2	1

See products on **P. 397**  
Ver productos en / Voir produits en page

**Clear GN lids for presentation**  
Tapas GN transparentes presentación  
Couvercles GN transparents de présentation



# 13 Terracota



# Terracota 13

**P22740** Tapas dish  
Plato tapas  
Plat à tapas



REF	Ø cm	H cm	
P22740	19,0	4,0	1
P22741	24,0	5,1	1
P22742	28,5	6,5	1
P22743	35,5	6,5	1

**P22744** Tapas dish  
Plato tapas  
Plat à tapas



REF	Ø cm	H cm	
P22744	10,5	3,5	1
P22745	13,0	4,0	1
P22746	15,5	4,5	1

**P22700** Conical bowl  
Bol cónico  
Bol conique



REF	Ø cm	H cm	
P22700	9,5	5,5	1
P22701	11,5	5,5	1
P22702	15,0	6,0	1
P22703	18,0	9,5	1
P22704	20,5	7,5	1
P22705	23,0	8,0	1

**P22710** Tapas dish  
Plato tapas  
Plat à tapas



REF	Ø cm	H cm	
P22710	10,5	3,5	1
P22711	15,5	4,5	1
P22712	18,0	4,5	1

**P22750** Square tray  
Bandeja cuadrada  
Plateau carré



REF	W x D x H cm	
P22750	20,5 x 20,5 x 3	1
P22751	25,5 x 25,5 x 3,5	1
P22752	29 x 29 x 4	1

**P22755** Rectangular tray  
Bandeja rectangular  
Plateau rectangulaire



REF	W x D x H cm	
P22755	21 x 11 x 2	1
P22756	26 x 13 x 3	1

**P22760** Snacks or sauce tray  
Bandeja snacks o salsas  
Plateaux sauces



REF	W x D x H cm	
P22760	29,5 x 9,5 x 3	1

**P22770** Serving plate  
Plato presentación  
Assiette présentation



REF	W x D x H cm	
P22770	22 x 18,5 x 1	1
P22772	44,5 x 35 x 1,5	1

**P22419** 6 compartment tray  
Bandeja 6 compartimentos  
Plateau 6 compartiments



REF	W x D x H cm	
P22419	41 x 7 x 3,8	1

**NEW!**

# 13 Stone



**P22824 Round bowl**  
Bol redondo  
Bol rond



REF	Ø cm	H cm	
P22824	11,5	4,0	1
P22823	14,0	5,5	1
P22825	19,0	6,5	1

**P22815 Plate**  
Plato  
Assiette



REF	Ø cm	H cm	
P22815	22,5	3,0	1
P22816	25,0	3,0	1
P22817	27,5	3,5	1

**P22850 Curved board**  
Tabla presentación curvada  
Planche incurvée préentaion

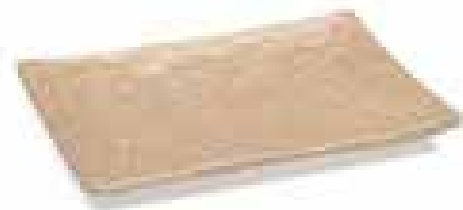

REF	W x D x H cm	
P22850	20 x 14 x 2	1
P22851	25 x 17,5 x 2,5	1
P22852	30 x 20 x 2,5	1

**P22800 Serving board**  
Tabla presentación  
Planche de service



REF	W x D x H cm	
P22800	21 x 12 x 2,5	1
P22801	24 x 14 x 2,5	1
P22802	27 x 18 x 2,5	1
P22803	33 x 19 x 2,5	1

# Elegance 13



**P22782 Oblong display tray**  
Bandeja exhibición rectangular  
Plateau rectangulaire



REF	W x D x H cm	
P22782	35 x 25 x 4	1

**P22780 Oblong plate**  
Fuente rectangular  
Plateau rectangulaire



REF	W x D x H cm	
P22780	25 x 16 x 3	1

**P22781 Rectangular tray**  
Bandeja rectangular  
Plateau rectangulaire



REF	W x D x H cm	
P22781	32 x 12 x 2,5	1

**P22783 Oval serving dish**  
Fuente oval  
Plat ovale



REF	W x D x H cm	
P22783	35 x 15 x 2,5	1

**P22784 Leaf plate**  
Bandeja forma hoja  
Plateau forme feuille



REF	W x D x H cm	
P22784	34,5 x 13,5 x 3	1

# 13 Mediterranean



**P22725** Dish  
Plato  
Assiette



REF	Ø cm	H cm	
P22720	22,0	2,0	1
P22725	27,0	2,0	1

**P22726** Deep dish  
Plato hondo  
Assiette creuse



REF	Ø cm	H cm	
P22726	20,0	3,5	1

**P22727** Oblong plate  
Fuente rectangular  
Plateau rectangulaire



REF	W x D x H cm	H cm	
P22727	20 x 14,5 x 4,5	4,5	1
P22728	23 x 17,5 x 4,5	4,5	1
P22729	27 x 20 x 4,5	4,5	1

**P22758** Round bowl  
Bol redondo  
Bol rond



REF	Ø cm	H cm	
P22758	12,5	7,0	1

**P22759** Glass  
Vaso  
Verre



REF	Ø cm	H cm	
P22759	8,0	9,5	1

# Colors 13



**P22830** Serving plate  
Plato presentación  
Assiette présentation



Yellow / Amarillo / Jaune

REF	Ø cm	H cm	
P22830	22	2,5	1
P22833	28	2,5	1

**P22834** Serving plate  
Plato presentación  
Assiette présentation



Grey / Gris / Gris

REF	Ø cm	H cm	
P22834	22	2,5	1
P22835	28	2,5	1

**P22838** Serving plate  
Plato presentación  
Assiette présentation



Orange / Naranja

REF	Ø cm	H cm	
P22838	22	2,5	1
P22839	28	2,5	1

**P22844** Serving plate  
Plato presentación  
Assiette présentation



Red / Rojo / Rouge

REF	Ø cm	H cm	
P22844	22	2,5	1
P22845	28	2,5	1

MELAMINE  
MELAMINA  
MELAMINE

MELAMINE  
MELAMINA  
MELAMINE

# 13 Cool-line



Me  
Melamine

# Cool-line 13



Me  
Melamine

**P22884** Glass  
Vaso  
Verre

**P23800** Mini round casserole with lid  
Mini cacerola con tapa  
Mini cocotte avec couvercle

**P22370** Two tones deep squared bowl  
Bol cuadrado hondo dos colores  
Bol carré deux couleurs

**P22371** Two tones deep squared bowl  
Bol cuadrado hondo dos colores  
Bol carré deux couleurs



REF	Ø cm	H cm	ml	
P22884A	8,5	9	30	1
P22884N	8,5	9	30	1
P22884G	8,5	9	30	1
P22884R	8,5	9	30	1
P22884B	8,5	9	30	1
P22884NE	8,5	9	30	1

REF	Ø cm	H cm	
P23800A	10	6,5	1
P23800N	10	6,5	1
P23800G	10	6,5	1
P23800R	10	6,5	1

REF	W x D x H cm	
P22370A	9 x 9 x 5,5	1
P22370N	9 x 9 x 5,5	1
P22370G	9 x 9 x 5,5	1
P22370R	9 x 9 x 5,5	1

REF	W x D x H cm	
P22371A	18 x 18 x 8,5	1
P22371N	18 x 18 x 8,5	1
P22371G	18 x 18 x 8,5	1
P22371R	18 x 18 x 8,5	1

**P22223** Wood base for 3 mini casseroles  
Base de madera para 3 mini cacerolas  
Base en bois pour 3 mini cocottes

Wo  
Wood



**IDEA!** Suitable for P23800, P23800A, P23800N, P23800G, P23800R.  
Compatible con P23800, P23800A, P23800N, P23800G, P23800R.  
Adaptable pour P23800, P23800A, P23800N, P23800G, P23800R.

REF	W x D x H cm	
P22223	43 x 15,5 x 5,1	1

**P590007** Lid  
Tapa  
Couvercle

PP  
Polypropylene



**Non-hermetic closure**  
Cierre no hermético  
Fermeture non hermétique

**Minimum purchase: pack of 6 units**  
Compra mínima: pack 6u  
Achat minimum : pack de 6 unités

REF	W x D x H cm	
P590007	18 x 18 x 2,5	6

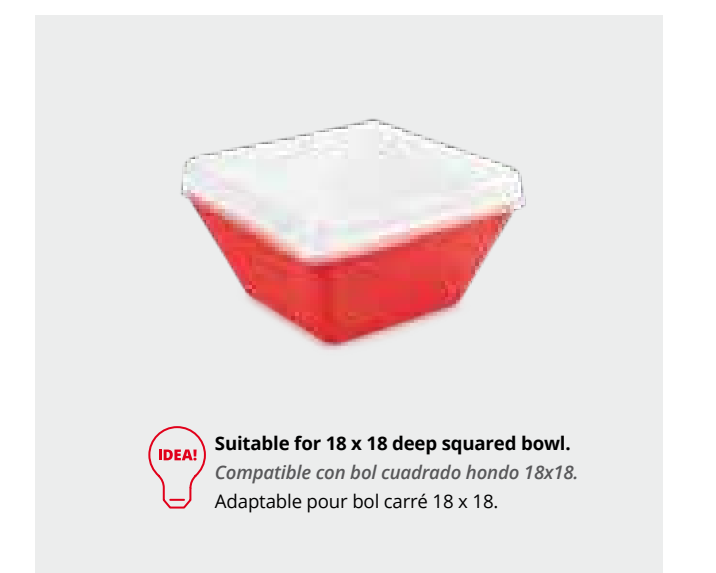

**IDEA!** Suitable for 18 x 18 deep squared bowl.  
Compatible con bol cuadrado hondo 18x18.  
Adaptable pour bol carré 18 x 18.

# 13 Zen



**P2290 Dish**  
Plato  
Assiette



REF	Ø cm	H cm	📦
P22901	19,5	2,8	12
P22902	28,0	2,9	12

**P2291 Bowl**  
Bol  
Bol



REF	Ø cm	H cm	📦
P22911	10,1	4,0	12
P22912	11,5	5,8	12

**P2294 Rectangular Tray**  
Bandeja rectangular  
Plateau rectangulaire



REF	W x D x H cm	📦
P22940	23,4 x 14,7 x 2,5	12

**P2297 Noodles bowl**  
Bol para noodels  
Bol pour nouilles



REF	Ø cm	H cm	📦
P22971	17,3	7,6	12
P22972	25,0	8,7	6

**P2296 Sauce bowl**  
Bol para salsas  
Bol pour sauces



Suitable for P22950.  
Compatible con P22950.  
Adaptable pour P22950.



REF	Ø cm	H cm	📦
P22960	11,5	5,5	20

**P2295 Dish for bowl**  
Plato para bol  
Assiette pour bol



Suitable for P22960.  
Compatible con P22960.  
Adaptable pour P22960.



REF	W x D x H cm	📦
P22950	15,9 x 12,7 x 2,3	12

# Shell 13



**P22354 Plate**  
Fuente  
Plateau



P22354



P22355

REF	W x D x H cm	📦
P22354	25 x 23,5 x 3	1
P22355	40 x 38,5 x 6,5	1

**P22356 Plate**  
Fuente  
Plateau



REF	W x D x H cm	📦
P22356	35 x 26,5 x 3,5	1
P22357	46 x 35 x 5	1

**P22358 Plate**  
Fuente  
Plateau



REF	W x D x H cm	📦
P22358	28,5 x 27,5	1

# 13 Blanche



Me  
Melamine

# Ola 13



Me  
Melamine

**P22420** Rectangular tray  
Bandeja rectangular  
Plateau rectangulaire

**NEW!**



REF	W x D x H cm	
P22420	26,5 x 11 x 2,3	1
P22421	37 x 11 x 2,5	1

**P22349** Rectangular tray  
Bandeja rectangular  
Plateau rectangulaire



REF	W x D x H cm	
P22349	25 x 18 x 3,5	1
P22350	30 x 21,5 x 4	1
P22351	35 x 25 x 4	1

**P2297** Round bowl  
Bol redondo  
Bol rond



P. 393



REF	Ø cm	H cm	
P22973	25	11	1
P22974	28	12	1
P22975	35	15	1

**P22170** Leaf plate  
Bandeja forma hoja  
Plateau forme feuille



REF	W x D x H cm	
P22170	50,5 x 24 x 7	3

**P22352** Round bowl  
Bol redondo  
Bol rond



REF	Ø cm	H cm	
P22352	17,5	5,5	1
P22353	24,0	8,0	1

## Fontana

**P22359** Slanted round bowl  
Bol redondo inclinado  
Bol rond incliné

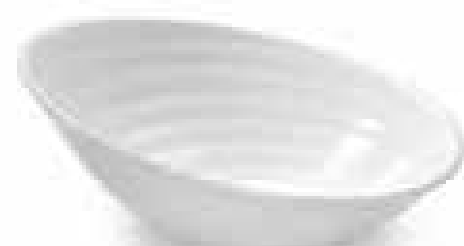

REF	W x D x H cm	
P22359	35,5 x 32 x 14,5	1
P22360	46 x 40,5 x 18,5	1

**P22169** Oval bowl  
Bol oval  
Bol ovale



REF	W x D x H cm	
P22169	29 x 16,5 x 15	6

**P2217** Spin round bowl  
Bol torneado  
Bol tourné



REF	Ø cm	H cm	
P22171	20,5	9,5	3
P22172	24,5	10,5	3
P22173	28,0	12,0	3

# 13 Sharing



Me  
Melamine

**P22037 High oblong plate**  
Fuente rectangular alta  
Plateau rectangular haut

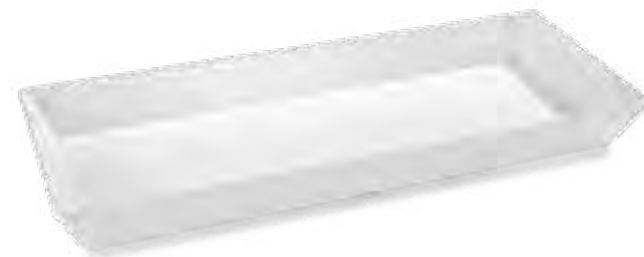

REF	W x D x H cm	📦
P22037	50 x 20 x 5	3

**P22038 High oblong plate**  
Fuente rectangular alta  
Plateau rectangular haut



REF	W x D x H cm	📦
P22038	35 x 25 x 5	3

**P22164 High oblong serving dish**  
Fuente rectangular alta  
Plateau rectangular haut



REF	W x D x H cm	📦
P22164	25 x 15 x 7	3
P22165	35 x 25 x 7	3
P22166	45 x 30 x 7	2

**P22103 5 - Compartment bowl**  
Bandeja 5 compartimentos  
Bol 5 compartiments



**IDEA!** Central space ideal for sauces and dips.  
Espacio central ideal para salsas y dips.  
Espace central idéal pour sauces et tartiner.

REF	Ø cm	H cm	📦
P22103	38	6,5	3

# Sharing 13

Me  
Melamine

**P22501 Oval serving dish**  
Fuente oval  
Plat ovale



REF	W x D x H cm	📦
P22501	32,5 x 20 x 4	1
P22502	43,5 x 26,5 x 4	1

**P2210 Round bowl**  
Bol redondo  
Bol rond



REF	Ø cm	H cm	📦
P22100	16	9	6
P22101	26	10	6
P22102	36	13	3

**P2222 Bamboo displayer with 3 bowls**  
Expositor bambú con 3 bols  
Présentoir bambou avec 3 bols

Wo  
Wood

Me  
Melamine



REF	L cm	Ø cm	H cm	Lts	📦
P22220	29,0	11	3,5	0,20	6
P22221	40,0	13	6,0	0,50	6
P22222	49,5	16	8,5	1,10	6

**P2216 Conical bowl**  
Bol cónico  
Bol conique



REF	Ø cm	H cm	📦
P22167	13	8,5	6
P22168	16	10,8	6

**P22003 Squared display plate**  
Bandeja exhibición cuadrada  
Plateau carré présentation

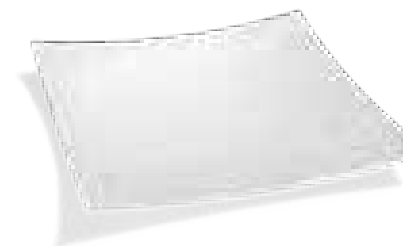

REF	W x D x H cm	📦
P220031	31 x 31 x 4	3
P22003	35 x 35 x 4	3
P220033	42 x 42 x 5	3

**P22177 Round plate**  
Bandeja redonda  
Plateau rond



REF	Ø cm	H cm	📦
P22177	35	3,5	3





**P22002 Squared display plate**  
Bandeja exhibición cuadrada  
Plateau carré présentation



REF	W x D x H cm	
P220021	30,5 x 30,5 x 3,5	3
P22002	35,5 x 30,5 x 4	3
P220023	40,5 x 40,5 x 4,5	3

**P222 Deep squared bowl**  
Bol cuadrado hondo  
Bol carré



REF	W x D x H cm	
P22211	7 x 7 x 4,2	24
P22200	9 x 9 x 5,5	12
P22201	13 x 13 x 7	6
P22202*	18 x 18 x 8,5	6
P22203	24 x 24 x 10	3
P22204	30 x 30 x 11,5	3

**P2200 Squared tray**  
Fuente cuadrada  
Plateau carré



REF	W x D x H cm	
P22001	33,5 x 33,5 x 5,5	3
P22000	37,3 x 37,3 x 2,8	3

**P2201 Oblong plate**  
Fuente rectangular  
Plateau rectangulaire



REF	W x D x H cm	
P22012	35,8 x 20,5 x 3,8	3
P22013	44,3 x 22,1 x 4,4	3
P22014	49,5 x 27,2 x 5,6	3
P22015	55,7 x 32,2 x 5,2	3
P22016	71 x 40,5 x 5,3	3

**P2220 Two tones deep squared bowl**  
Bol cuadrado hondo dos colores  
Bol carré deux couleurs



REF	W x D x H cm	Red Rojo Rouge	Blue Azul Bleu	Yellow Amarillo Jaune	Green Verde Vert	Black Negro Noir	
P22200	9 x 9 x 5,5	R	A	AM	V	N	12
P22202	18 x 18 x 8,5*	R	A	AM	V	N	6
P22203	24 x 24 x 10	R	A	AM	V	N	3

REF + Color code / REF + Código color / REF + Code couleur

See products on **P. 415**  
Ver productos en / Voir produits en page

- \* Fits in CUBIC display.
- \* Encaja en expositores CUBIC.
- \* Adaptable aux présentoirs CUBIC.



**P2208 Oblong display tray**  
Bandeja exhibición rectangular  
Plateau rectangulaire



REF	W x D x H cm	
P22085	39 x 15 x 1,5	6
P22086	50 x 18 x 1,8	6

**P22099 Bowl - plate**  
Plato - bol  
Plat - bol



REF	Ø cm	H cm	
P22099	38	9	6

**P2215 Gastronorm tray**  
Bandeja gastronorm  
Plateau gastronorme



REF	W x D x H cm	
P22150	53 x 32,5 x 2	3
P22151	32,5 x 26,5 x 2	6

**P22004 Deep squared bowl**  
Bol cuadrado  
Bol carré



REF	W x D x H cm	
P22004	25 x 25 x 8,8	3
P22005	37,5 x 37,5 x 9	3

# 13 Complet Table



Me  
Melamine

**P2211** Round dish  
*Plato*  
Assiette plate



REF	Ø cm	H cm	
P22111	16,0	2,3	12
P22112	20,0	2,3	12
P22113	23,0	2,3	6
P22114	26,5	2,3	6

**P22115** Soup plate  
*Plato sopa*  
Assiette à soupe



REF	Ø cm	H cm	
P22115	24	3,7	6

**P22116** Big salad bowl  
*Bol grande*  
Saladier grand



REF	Ø cm	H cm	
P22116	19	5	6

**P22182** Oval dish  
*Plato oval*  
Assiette ovale



REF	W x D x H cm	
P22182	24,3 x 18,2 x 2,1	6
P22183	30,5 x 23,2 x 2,5	6
P22184	34,2 x 26,8 x 2,7	6

# Complet Table 13

Me  
Melamine

**P2225** Stackable bowl  
*Bol cereales encastable*  
Bol empilable



REF	Ø cm	H cm	
P22250	12	4,5	12
P22251	14	5,5	12

**P22117** Small salad bowl  
*Bol pequeño*  
Saladier petit



REF	Ø cm	H cm	
P22117	14	6	12

**P22178** Cup - Plate  
*Taza - Plato*  
Tasse - Assiette



	REF	Size	Ø cm	H cm	Lts	
Cup / Taza Tasse	P22178	S	7,0	4,8	0,10	12
	P22180	L	9,8	6,5	0,25	12
Plate / Plato Assiette	P22179	S	10,3	-	-	12
	P22181	L	14,4	-	-	12

**P22118** Stackable mug  
*Taza apilable*  
Tasse empilable



REF	Ø cm	H cm	Lts	
P22118	7,5	10	0,30	6

**P22033** Slotted spoon  
*Cuchara perforada*  
Cuillère ajourée



REF	L cm	
P22033	30	24

**P22034** Soup ladle  
*Cacillo*  
Louche



REF	L cm	Lts	
P22034	17	0,08	24

# 13 Venus



**P22023** Oval plate  
Fuente oval honda  
Plateau ovale



REF	W x D x H cm	
P22023	50 x 36 x 6,7	3

**P22022** Round bowl  
Fuente redonda  
Bol rond



REF	Ø cm	H cm	
P22022	36	7	3

**P22019** Round bowl  
Bol redondo  
Bol rond



REF	Ø cm	H cm	
P22019	20	9,0	3
P22020	28	12,5	3

**P22174** Slanted round bowl  
Bol redondo inclinado  
Bol rond incliné



REF	W x D x H cm	Lts	
P22174	21,2 x 20,8 x 10,4	0,60	6
P22175	30 x 29,1 x 13,7	1,60	3
P22176	36 x 34,9 x 16,3	2,85	3

**P22090** Round plate presentation  
Plato redondo de presentación  
Plateau rond présentation



REF	Ø cm	H cm	
P22090	31	2	4

**P22364** Round bowl  
Bol redondo  
Bol rond



REF	Ø cm	H cm	
P22364	22,5	11,5	3
P22365	26,0	14,0	3

# Wood board 13



**P2260** Oak display plate  
Soporte presentación roble  
Présentoir chêne



With non-slip feet  
Con pies antideslizantes  
Avec pieds antidérapants



REF	Mod.	cm	
P22600	1/1	53,0 x 32,5	3
P22601	1/2	32,5 x 26,5	6
P22602	1/3	32,5 x 17,6	6
P22603	1/4	26,5 x 16,2	6
P22604	2/4	53,0 x 16,5	6

**P2262** Oak serving tray  
Bandeja presentación roble  
Plateau présentation bois

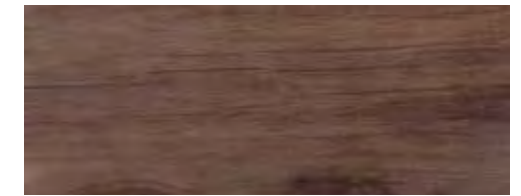
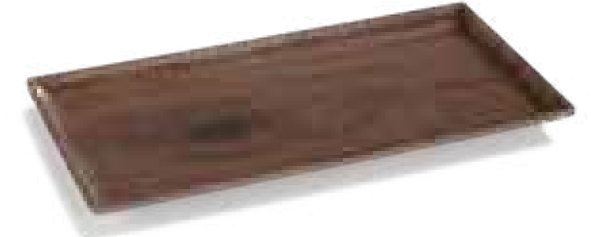

REF	W x D x H cm	
P22620	30 x 15 x 1,8	12
P22621	30 x 20 x 1,8	12
P22622	40 x 30 x 1,8	6

**P2261** Display plate  
Soporte presentación  
Présentoir



With non-slip feet  
Con pies antideslizantes  
Avec pieds antidérapants

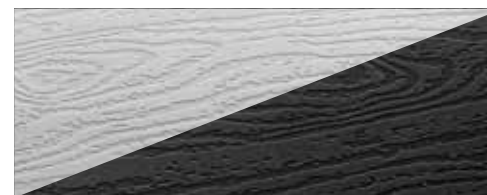

REF	Mod.	cm	Blanco White Blanc	Negro Black Noir	
P22610	1/1	53,0 x 32,5	B	N	3
P22611	1/2	32,5 x 26,5	B	N	4
P22614	2/4	53,0 x 16,5	B	N	6

REF + color code / REF + código color / REF + code couleur

**P22690** Slate display plate  
*Soporte presentación pizarra*  
 Présentoir base ardoise

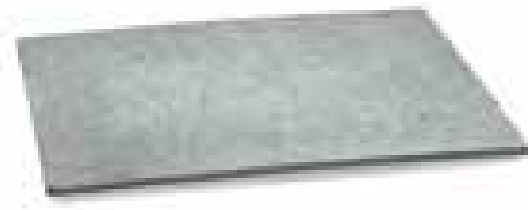

REF	Mod.	W x D x H cm	
P22690	1/2	32,5 x 26,5 x 1	24
P22691	1/3	32,5 x 17,5 x 1	24
P22692	1/4	26,5 x 16,0 x 0	24

**P2264** Slate display plate  
*Bandeja base pizarra*  
 Présentoir base ardoise



With non-slip feet  
 Con pies antideslizantes  
 Avec pieds antidérapants

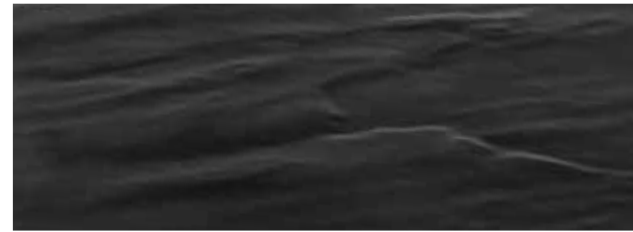

REF	Mod.	cm	
P22640N	1/2	32,5 x 26,5	6
P22641N	1/3	32,5 x 17,5	6
P22642N	1/4	26,5 x 16,0	6

**P22161** Slate - granite Display plate  
*Soporte presentación Pizarra - granito*  
 Présentoir Ardoise - granite

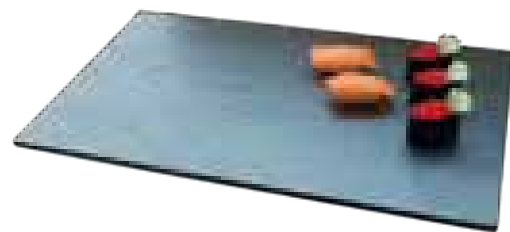

Reversible: 1 slate side - 1 granite side  
 Reversible: 1 cara pizarra - 1 cara granito  
 Réversible: 1 face ardoise - 1 face granite

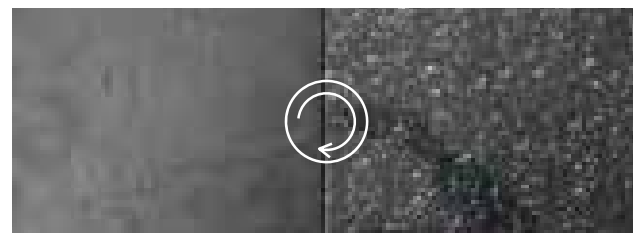

REF	Mod.	W x D x H cm	
P22161	1/1	53,0 x 32,5 x 0,7	3
P22162	1/2	32,5 x 26,5 x 0,7	3

**P22124** Display plate  
*Soporte presentación*  
 Présentoir



REF	Ø cm	H cm	
P22124	23,0	1,5	1
P22125	28,0	1,5	1
P22126	32,5	1,5	1

**P22144** Double face slate - bamboo display plate  
**P22145** *Soporte presentación doble cara pizarra - bambú*  
 Présentoir double face bambou - ardoise



Reversible: 1 slate side - 1 bamboo side  
 Reversible: 1 cara pizarra - 1 cara bambú  
 Réversible: 1 face ardoise - 1 face bambou

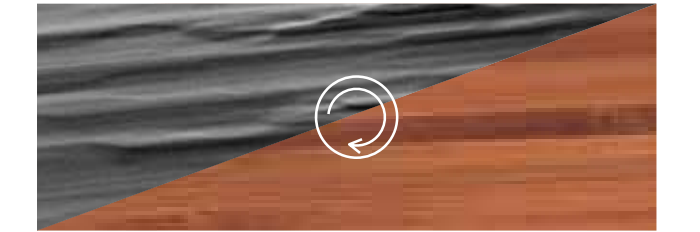

REF	Ø cm	H cm	
P22144	33	1	3
P22145	43	1	3

**P22695** Marble display plate  
*Soporte presentación mármol*  
 Présentoir base marbre



REF	Mod.	W x D x H cm	
P22695	1/1	53,0 x 32,5 x 2	9
P22696	1/2	32,5 x 26,5 x 2	12
P22697	1/3	32,5 x 17,6 x 2	24
P22698*		15 x 15 x 9,5	48

# 13 GN Classic Colors



## GN 1/1 530 x 325 mm

**Yellow**  
Amarillo  
Jaune



REF	H mm	
P22866	20	6
P22867	40	3
P22868	65	2

**Orange**  
Naranja  
Orange



REF	H mm	
P22863	20	6
P22864	40	3
P22865	65	2

**Red**  
Rojo  
Rouge



REF	H mm	
P22869	20	6
P22870	40	3
P22871	65	2

**Grey**  
Gris  
Gris



REF	H mm	
P22860	20	6
P22861	40	3
P22862	65	2

## GN 1/2 325 x 265 mm

**Yellow**  
Amarillo  
Jaune



REF	H mm	
P22878	20	6
P22879	40	3
P22880	65	2

**Orange**  
Naranja  
Orange



REF	H mm	
P22875	20	6
P22876	40	3
P22877	65	2

**Red**  
Rojo  
Rouge



REF	H mm	
P22881	20	6
P22882	40	3
P22883	65	2

**Grey**  
Gris  
Gris



REF	H mm	
P22872	20	6
P22873	40	3
P22874	65	2

# GN Classic Black 13



## GN 1/1 530 x 325 mm



REF	H mm	
P22051	20	6
P22053	40	3
P22009	65	2

## GN 2/3 353 x 325 mm



REF	H mm	
P22047	65	3

## GN 2/4 530 x 162 mm



REF	H mm	
P22049	65	3

## GN 1/3 325 x 175 mm



REF	H mm	
P22011	65	3
P22080	100	3

## GN 1/2 325 x 265 mm



REF	H mm	
P22039	20	6
P22041	40	3
P22010	65	3
P22084	100	3

## GN 1/4 265 x 162 mm



REF	H mm	
P22043	65	3

## GN 1/6 176 x 162 mm



REF	H mm	
P22045	65	6
P22082	100	6

# 13 Grey Soul



## GN SLIM SLIM PAN CUBETA LIGERA BAC LÉGER

**ECONOMIC LINE**  
GAMA ECONÓMICA  
GAMME ECONOMIQUE

**IDEA!** Ideal for cold buffets.  
Ideal buffets fríos.  
Idéal pour buffets froids

Stackable  
Apilable  
Empilable

Stylized  
Estilizada  
Stylisée

CLASSIC  
Current pan  
Cubeta tradicional  
Bac traditionnel

1/1 1/2 1/4 1/3 2/4 1/6

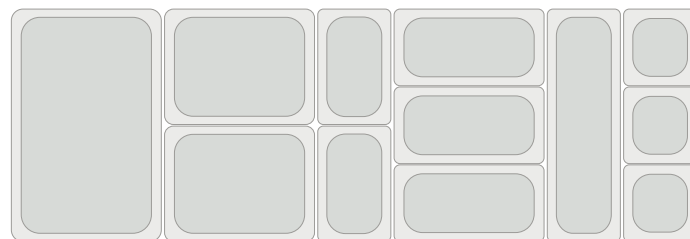

# GN Slim 13



**GN 1/1** 530 x 325 mm



REF	H mm	
P23030	20	12
P23031	65	6
P23032	100	6

**GN 1/2** 325 x 265 mm



REF	H mm	
P23033	20	24
P23034	65	12

**GN 2/4** 530 x 162 mm



REF	H mm	
P23044	20	12
P23045	65	12
P23046	100	12

**GN 1/3** 325 x 176 mm



REF	H mm	
P23036	20	24
P23037	65	24
P23038	100	12

**GN 1/4** 265 x 162 mm



REF	H mm	
P23039	20	48
P23040	65	24

**GN 1/6** 176 x 162 mm



REF	H mm	
P23042	65	24
P23043	100	24

## GN 1/1 530 x 325 mm



REF	H mm	
P22052	20	6
P22054	40	3
P22006	65	2

## GN 1/2 325 x 265 mm



REF	H mm	
P22040	20	6
P22042	40	3
P22007	65	3
P22083	100	3

## GN 2/3 353 x 325 mm



REF	H mm	
P22048	65	3

## GN 1/3 325 x 175 mm



REF	H mm	
P22094	20	6
P22008	65	3
P22079	100	3

## GN 2/4 530 x 162 mm



REF	H mm	
P22087	20	6
P22050	65	3

## GN 1/4 265 x 162 mm



REF	H mm	
P22044	65	3

## GN 1/6 176 x 162 mm



REF	H mm	
P22046	65	6
P22081	100	6

## P22154 1/1 Gastronorm buffet displayer Expositor buffet para cubetas GN 1/1 Présentoir buffet pour bacs GN 1/1



REF	tipo/type	W x D x H cm	
P22154	1/1	56,5 x 52,5 x 32,5	6

## P22156 1/3 Gastronorm buffet displayer Expositor buffet para cubetas GN 1/3 Présentoir buffet pour bacs GN 1/3



Containers not included  
Cubetas no incluidas  
Bacs non inclus

REF	tipo/type	W x D x H cm	
P22156	1/3	36 x 52,5 x 32,5	6

## P22158 4 Crocks system stand Expositor 4 vasijas Présentoir 4 cruches



P22160  
Crocks not included  
Vasijas no incluidas  
Cruches pas incluses

REF	W x D x H cm	
P22158	19 x 52,5 x 32,5	6

## P22160 1l crock Vasija 1l Cruche 1l



REF	Ø cm	H cm	
P22160	13	10,5	6

# 13 Mini White



**P22108** Squared bowl  
*Platillo cuadrado*  
Bol carré



REF	W x D x H cm	Lts	
P22108	10 x 10 x 3,3	0,10	24
P22109	12,5 x 12,5 x 3,5	0,18	24

**P22088** Egg cup  
*Platillo para huevo*  
Coquetier



REF	W x D x H cm	
P22088	11,5 x 11,5 x 2	24

**P22119** Snack or sauce melamine tray  
*Bandeja melamina snacks o salsas*  
Plateaux mélamine snacks ou sauces



**NEW!**

2 compartments  
2 compartimentos  
2 compartiments

REF	W x D x H cm	
P22119	17,5 x 8,5 x 3,5	1

**P867** Ramekin  
*Recipiente para salsas*  
Récipient pour sauces



**P22104** Mini square plate  
*Mini bandeja presentación*  
Plateau miniature



REF	W x D x H cm	
P22104	12,5 x 10,5 x 2	24
P22105	14 x 13 x 2	24
P22106	17 x 14 x 2,5	24

**P22890** Small tray  
*Fuente rectangular*  
Ravier rectangulaire



Stackable  
Apilable  
Empilable

REF	W x D x H cm	
P22890	13 x 9 x 2	24

**P22110** Party spoon  
*Cuchara degustación*  
Cuillère amuse bouche



REF	W x D x H cm	
P22110	14,5 x 4,5 x 5	60

REF	Ø cm	H cm	
P867030	5,8	2,7	12
P867060	7,0	3,7	12
P867090	7,8	4,0	12
P867120	8,5	4,5	12



# Mini Black 13

**P23840** Mini oval casserole  
*Mini cacerola oval*  
Mini casserole ovale



REF	W x D x H cm	L cm	
P23840	12 x 8 x 3,5	15,5	96
P23841	21 x 14 x 3,5	26,5	96

**P23830** Mini hot plate with handles  
*Mini parrilla con asas*  
Mini grill avec poignées



REF	W x D x H cm	L cm	
P23830	26 x 16 x 2	32	96

**P23825** Mini round fry pan  
*Mini sartén redonda*  
Mini poêle ronde



REF	Ø cm	L cm	H cm	
P23825	11	16	3,0	96

**P23836** Mini round casserole  
*Mini cacerola redonda*  
Mini cocotte ronde



REF	Ø cm	L cm	H cm	
P23835	11,5	15	3,5	96
P23836	14,5	19	3,5	96

**P23824** Mini squared fry pan  
*Mini sartén cuadrada*  
Mini poêle carrée



REF	W x D x H cm	L cm	
P23824	12,5 x 10,5 x 2	16	96

**P23800** Mini round casserole with lid  
*Mini cacerola con tapa*  
Mini cocotte avec couvercle



REF	Ø cm	H cm	L cm	
P23800	10	6,5	0,25	1
P23810	14	8,0	0,75	1

See colors on  
Ver colores en  
Voir couleurs  
en page

**P. 358**



# 13 Mini Black



**P23842** Mini casserole  
Mini cacerola  
Mini cocotte



REF	Ø cm	H cm	
P23842	9	4,5	1

**P23843** Mini oval casserole  
Mini cacerola oval  
Mini cocotte ovale



REF	W x D x H cm	
P23843	18 x 13 x 4	1

**P23844** Mini rectangular casserole  
Mini cacerola rectangular  
Mini casserole rectangulaire



REF	W x D x H cm	
P23844	19,5 x 10 x 5	1

**P23845** Mini round fry pan  
Mini sartén redonda  
Mini poêle ronde



REF	Ø cm	L cm	H cm	
P23845	21,5	30,5	3,0	1

**P22120** Snacks or sauce tray  
Bandeja snacks o salsas  
Plateaux sauces



REF	W x D x H cm	
P22120	17,5 x 8,5 x 3,5	1

**P2293** Snacks or sauce tray  
Bandeja snacks o salsas  
Plateaux sauces



REF	W x D x H cm	
P22920	19 x 8 x 3	12
P22930	9,2 x 6,9 x 3,1	24

# Ashtrays 13

Ceniceros  
Cendriers



**P22035** Squared ashtray. Black  
Cenicero cuadrado. Negro  
Cendrier carré. Noir



REF	W x D x H cm	
P22035	9 x 9 x 3	1

**P22036** Round ashtray. Black  
Cenicero redondo. Negro  
Cendrier rond. Noir



REF	Ø cm	H cm	
P22036	10	4,5	1

**P22030** Windproof ashtray round with lid. Black  
Cenicero redondo con tapa. Negro  
Cendrier pour l'exterieur avec couvercle. Noir



REF	Ø cm	H cm	
P22030	14,5	6,0	6

**P22031** Round dinner ashtray. Black  
Cenicero redondo. Negro  
Cendrier rond. Noir



**BEST  
SELLER**

REF	Ø cm	H cm	
P22031	10	5,0	12

**P22185** Conical melamine ashtray. Black  
Cenicero cónico melamina. Negro  
Cendrier conique. Noir



REF	Ø cm	H cm	
P22185	10	2,7	24

MELAMINE  
MELAMINA  
MELAMINE

MELAMINE  
MELAMINA  
MELAMINE

# 14 Buffet & accessories

Buffet y accesorios

Buffet et accessoires



<b>14.1 DISPLAY STANDS &amp; BASKETS</b>	386
<i>PRESENTACIÓN Y EXPOSITORES</i> <i>PRÉSENTOIRS ET PRÉSENTOIRS CORBEILLES</i>	
<b>14.2 PROTECTION AND COVERS</b>	394
<i>PROTECCIÓN Y TAPAS / PROTECTION ET COUVERCLES</i>	
<b>14.3 BRONZE COOKWARE</b>	398
<i>BATERÍA DE COCINA BRONCE / BATTERIE DE CUISINE BRONZE</i>	
<b>14.4 COOL-LINE COLLECTION</b>	400
<b>14.5 SUPER SHAPES</b>	402
<i>BUFFET PRESENTATION STEAM TABLE PANS</i> <i>CUBETAS PRESENTACIÓN BUFFET / BACS PRÉSENTATION BUFFET</i>	
<b>14.6 MIRAMAR® COOKWARE</b>	406
<i>BATERÍA DE COCINA PARA PRESENTACIÓN</i> <i>BATTERIE DE CUISINE-PRÉSENTATION</i>	
<b>14.7 CUBIC</b>	412
<b>14.8 CHAFERS &amp; DISPENSERS</b>	428
<i>CHAFINGS Y DISPENSADORES / CHAFERS ET DISTRIBUTEURS</i>	
<b>14.9 BOWLS &amp; SERVING TRAYS</b>	436
<i>BOLS &amp; BANDEJAS DE SERVICIO / BOLS &amp; PLATEAUX</i>	
<b>14.10 SERVING TOOLS</b>	440
<i>UTENSILIOS DE SERVICIO / USTENSILES DE SERVICE BUFFET</i>	
<b>14.11 SIGNS</b>	450
<i>SEÑALIZACIÓN / SIGNALIZATION</i>	

# 14.1 Display stands & baskets

Presentación y expositores  
Présentoirs et présentoirs corbeilles



**NEW!**

## P598001 One tier flat display stand

Expositor metálico recto de un nivel  
Présentoir métallique droit à un niveau



**Baskets not included**  
Cestas no incluidas  
Panniers non inclus



REF	W x D x H cm	
P598001	45 x 30 x 20,5	1

## P598002 One tier angled display stand

Expositor metálico inclinado de un nivel  
Présentoir métallique incliné à un niveau



**Baskets not included**  
Cestas no incluidas  
Panniers non inclus



REF	W x D x H cm	
P598002	45 x 30 x 14,5	1

## P598003 Three tier flat display stand

Expositor metálico recto de 3 niveles  
Présentoir métallique droit 3 niveaux



**Baskets not included**  
Cestas no incluidas  
Panniers non inclus



REF	W x D x H cm	
P598003	30 x 24 x 51,5	1

# Display stands & baskets 14.1

Presentación y expositores  
Présentoirs et présentoirs corbeilles



## P591006 Rectangular metal wire basket

Cesta metálica rectangular  
Panier métallique rectangulaire



**Suitable for**  
Combinable con  
Adaptable pour  
P598001 / P598002

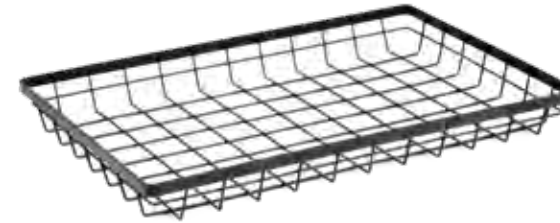

REF	W x D x H cm	
P591006	45 x 30 x 5	1

## P591007 Rectangular metal wire basket

Cesta metálica rectangular  
Panier métallique rectangulaire



**Suitable for**  
Combinable con  
Adaptable pour  
P598003



REF	W x D x H cm	
P591007	30 x 22,5 x 5	1

## P595001 Wooden box

Caja de madera  
Caisse en bois



**Suitable for**  
Combinable con  
Adaptable pour  
P598001 / P598002

**Stackable**  
Apilables  
Empilables



REF	W x D x H cm	
P595001	45 x 30 x 5	1
P595002	45 x 30 x 10	1

## P595003 Wooden box

Caja de madera  
Caisse en bois



**Suitable for**  
Combinable con  
Adaptable pour  
P598003

**Stackable**  
Apilables  
Empilables



REF	W x D x H cm	
P595003	30 x 22 x 5	1
P595004	30 x 22 x 10	1

# 14.1 Display stands & baskets

Presentación y expositores  
Présentoirs et présentoirs corbeilles



**NEW!**

Available in 3 colours: black, silver and gold in a matt finish.

Stackable.

Suitable for food contact.

Double functionality: tray and riser.

Made from 2 mm thick anodised aluminium providing great strength and toughness.

Disponibles en 3 colores: negro, plata y dorado en acabado mate.

Apilables.

Apta para contacto alimentario.

Doble funcionalidad: bandeja y riser.

Realizado en aluminio adonizado de 2 mm de grosor que ofrece gran robustez y resistencia.

Disponibles en 3 couleurs : noir, argent et doré en finition mate.

Empilables.

Adapté au contact alimentaire.

Double fonctionnalité : plateau et riser.

Fabriqué en aluminium anodisé de 2 mm d'épaisseur, ce qui lui confère une grande robustesse et une grande résistance.

**P317500** GN 1/1 buffet tray  
Bandeja buffet GN 1/1  
Plateau buffet GN 1/1

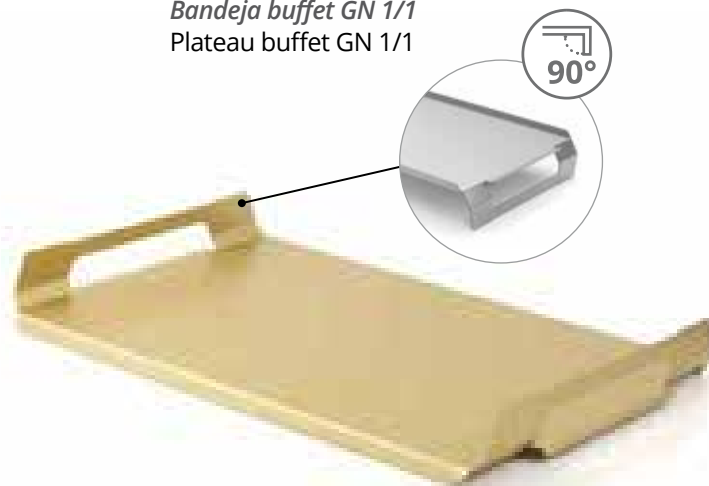

Ref. colour / Ref. color / Ref. couleur couvercle



**P317500B / P317500S / P317500G**  
Adaptable to GN 1/1 trolleys and food transport boxes with guides.  
Adaptables a carros GN 1/1 y cajas de transporte de alimentos con guías.  
Adaptables aux chariots GN 1/1 et aux caisses de transport de nourriture avec guides.



Click on the top of the handle to stack the trays stable and secure.  
Encaje en la parte superior del asa para apilar las bandejas de forma estable y segura.  
Enclenchez le dessus de la poignée pour empiler les plateaux de manière stable et sécurisée.

REF	External measures Medidas exteriores Dimensions extérieures W x D x H cm	Usable surface Superficie útil Surface utile cm	
P317500B	53 x 32,5 x 6,5	49,2 x 31	1
P317500S	53 x 32,5 x 6,5	49,2 x 31	1
P317500G	53 x 32,5 x 6,5	49,2 x 31	1

# Display stands & baskets 14.1

Presentación y expositores  
Présentoirs et présentoirs corbeilles



**P317100** Service and buffet trays  
Bandejas de servicio y buffet  
Plateaux de service et de buffet

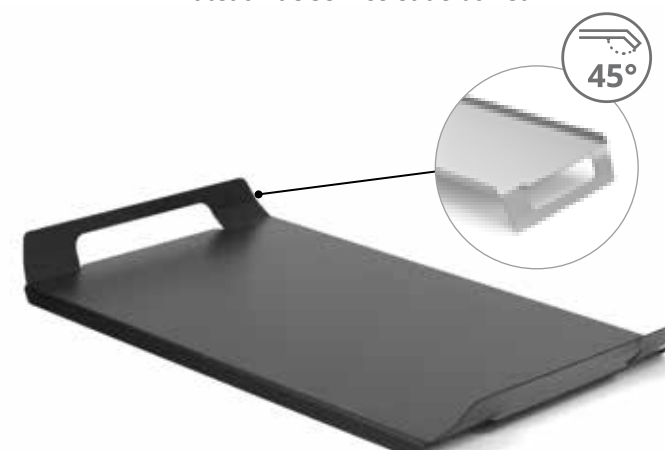

REF	External measures Medidas exteriores Dimensions extérieures W x D x H cm	Usable surface Superficie útil Surface utile cm	
P317100B	53 x 32,5 x 4,6	45,5 x 31	1
P317100S	53 x 32,5 x 4,6	45,5 x 31	1
P317100G	53 x 32,5 x 4,6	45,5 x 31	1

**P317200** Service and buffet trays  
Bandejas de servicio y buffet  
Plateaux de service et de buffet

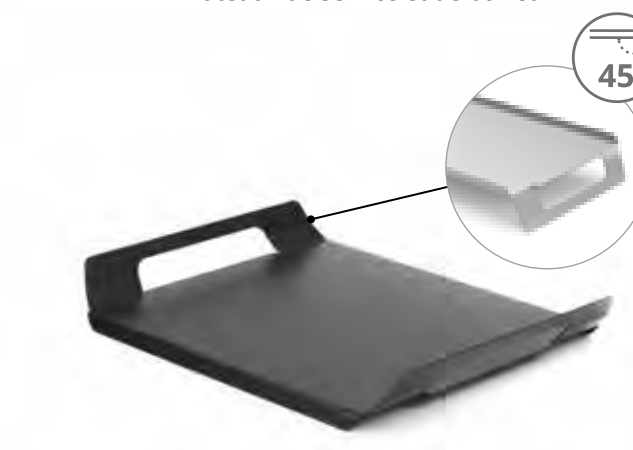

REF	External measures Medidas exteriores Dimensions extérieures W x D x H cm	Usable surface Superficie útil Surface utile cm	
P317200B	43,4 x 32,5 x 4,6	36 x 31	1
P317200S	43,4 x 32,5 x 4,6	36 x 31	1
P317200G	43,4 x 32,5 x 4,6	36 x 31	1

**P317300** Service and buffet trays  
Bandejas de servicio y buffet  
Plateaux de service et de buffet

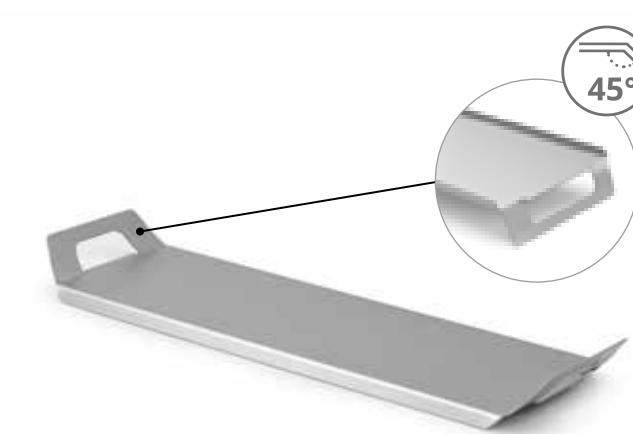

REF	External measures Medidas exteriores Dimensions extérieures W x D x H cm	Usable surface Superficie útil Surface utile cm	
P317300B	51,5 x 18,5 x 4	45,5 x 17	1
P317300S	51,5 x 18,5 x 4	45,5 x 17	1
P317300G	51,5 x 18,5 x 4	45,5 x 17	1

**P317400** Service and buffet trays  
Bandejas de servicio y buffet  
Plateaux de service et de buffet

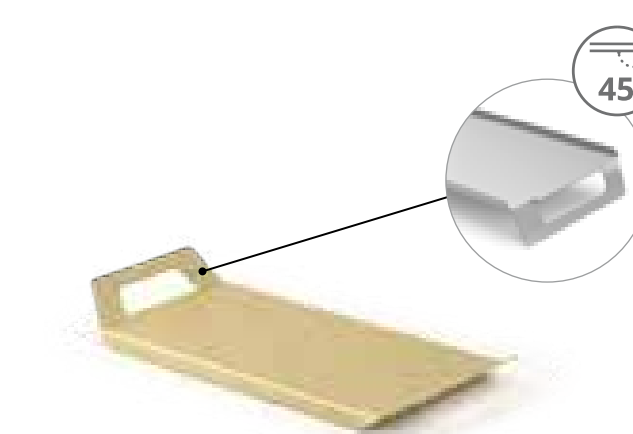

REF	External measures Medidas exteriores Dimensions extérieures W x D x H cm	Usable surface Superficie útil Surface utile cm	
P317400B	39 x 19,5 x 4	33 x 18	1
P317400S	39 x 19,5 x 4	33 x 18	1
P317400G	39 x 19,5 x 4	33 x 18	1

# 14.1 Display stands & baskets

Presentación y expositores  
Présentoirs et présentoirs corbeilles

Mt  
Metal

BUF  
FET

BEST  
SELLER



**P596110** Black GN wire basket  
Cesta rejilla GN negra  
Pannier metalique GN noir



1/1

REF	Mod	W x D x H cm	
P596110	1/1	52 x 31,5 x 12	6
P596111	1/1	52 x 31,5 x 16	6

**P596120** Black GN wire basket  
Cesta rejilla GN negra  
Pannier metalique GN noir



1/2

REF	Mod	W x D x H cm	
P596120	1/2	31,5 x 25,5 x 12	6
P596121	1/2	31,5 x 25,5 x 16	6

**P596130** Black GN wire basket  
Cesta rejilla GN negra  
Pannier metalique GN noir

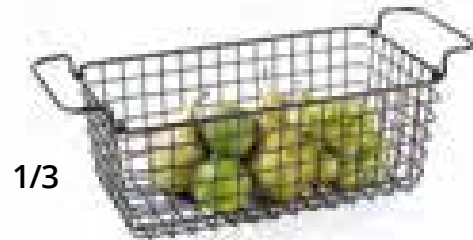

1/3

REF	Mod	W x D x H cm	
P596130	1/3	31,5 x 17 x 12	6
P596131	1/3	31,5 x 17 x 16	6

Suitable for  
Compatible con / Adaptable pour



P. 372

P. 373

P. 371

P. 391

# Display stands & baskets 14.1

Presentación y expositores  
Présentoirs et présentoirs corbeilles

Ba  
Bamboo

BUF  
FET

NATURAL  
FIBERS



Dos posiciones: derecho y revés.  
Two positions: right and reverse.  
Deux positions: droit et envers  
Zwei Positionen: rechts und rückwärts.



**P59511** GN buffet bamboo box  
Caja GN bambú buffet  
Présentoir GN buffet bambou



1/1

REF	Mod	H cm	
P595110	1/1	10	1
P595111	1/1	20	1

**P59512** GN buffet bamboo box  
Caja GN bambú buffet  
Présentoir GN buffet bambou



1/2

REF	Mod	H cm	
P595120	1/2	10	1
P595121	1/2	20	1

**P59513** GN buffet bamboo box  
Caja GN bambú buffet  
Présentoir GN buffet bambou

1/3



REF	Mod	H cm	
P595130	1/3	10	1
P595131	1/3	20	1

**P59510** Tray - Lid for GN buffet bamboo box  
Bandeja - Tapa para caja GN bambú buffet  
Plateau - Couverture pour présentoir GN buffet bambou



REF	Mod	H cm	
P595100	1/1	2	1
P595200	1/2	2	1
P595300	1/3	2	1

Suitable for  
Compatible con / Adaptable pour



P. 371

P. 372

P. 378

P. 397

# 14.1 Display stands & baskets

Presentación y expositores  
Présentoirs et présentoirs corbeilles

# Display stands & baskets 14.1

Presentación y expositores  
Présentoirs et présentoirs corbeilles



**P59711** Buffet displayer  
Expositor buffet  
Présentoir buffet

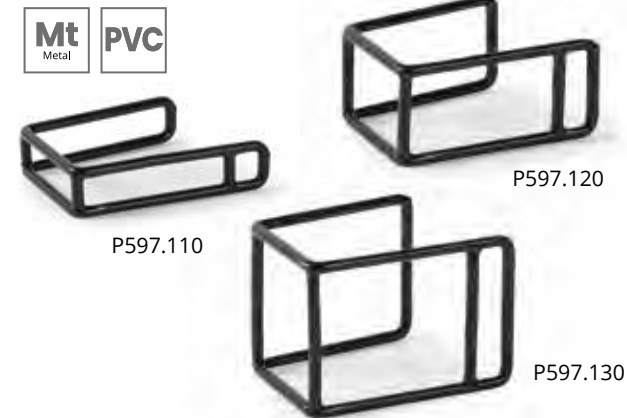

REF	W x D x H cm	
P597110	12,5 x 10,5 x 3	1
P597120	12,5 x 10,5 x 6	1
P597130	12,5 x 10,5 x 9	1

**19196** Angled Adaptor Plate  
Placa adaptadora angular  
Plaque intermédiaire inclinée



**Elevates pans to enhance food presentation**  
Eleva las cubetas para mejorar la presentación de los alimentos  
Élévage des bacs pour améliorer la présentation des aliments

REF	W x D x H cm	Type / Tipo	
19196	53 x 32,5 x 7,0	1 GN 1/1 (6°)	2

**P597170** Retractable display stand  
Expositor buffet extensible  
Présentoir buffet rétractable



REF	Max cm	Min cm	H cm Min / Max	
P597170	53 x 32,5	32,5 x 17,6	6,5 / 10	1

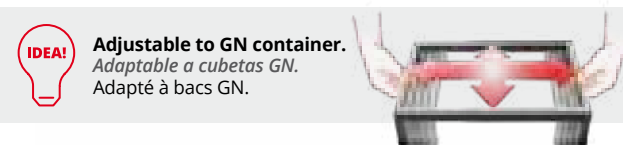

**P59714** Buffet displayer  
Expositor buffet  
Présentoir buffet

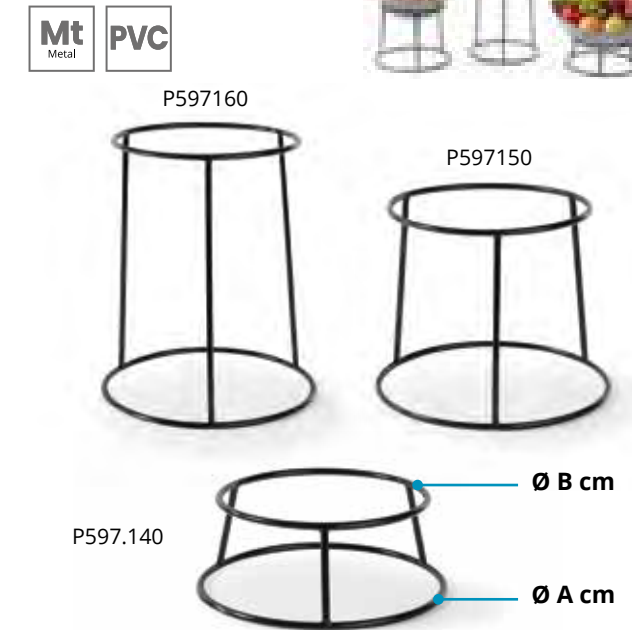

REF	Ø A cm	Ø B cm	H cm	
P597140	25	21	10	1
P597150	25	21	20	1
P597160	25	21	30	1

**4600960** Set of 3 Square Bent Risers  
Juego 3 expositores ángulos redondos  
Jeu de 3 socles carrés aux angles arrondis

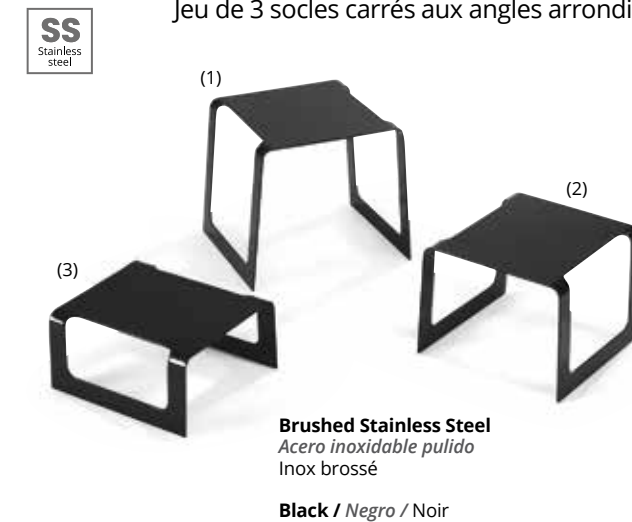

REF	W x D x H cm	
4600960	(1) 20,3 x 20,3 x 20,3 (2) 20,3 x 19,1 x 15,2 (3) 20,3 x 17,8 x 10,2	1

**46009** Set of 3 Square Bent Risers  
Juego 3 expositores ángulos redondos  
Jeu de 3 socles carrés aux angles arrondis

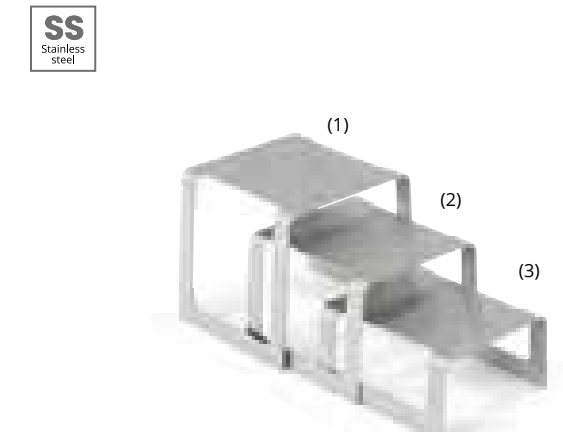

Brushed Stainless Steel  
Acero inoxidable pulido  
Inox brossé

REF	W x D x H cm	
46009	(1) 20,3 x 20,3 x 20,3 (2) 20,3 x 19,1 x 15,2 (3) 20,3 x 17,8 x 10,2	1

See products on  
Ver productos en / Voir produits en page

**Round bowl**  
Bol redondo  
Bol rond

P. 363



**Display plate**  
Soporte presentación  
Présentoir



P. 373

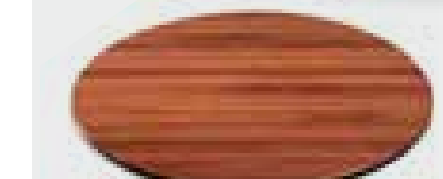

## 14.2 Protection and covers

Protección y tapas  
Protection et couvercles

### P19060 Mobile and ajustable breath guards Protección Anti-aliento regulable Pare-haleine ajustable



REF	W x D x H cm	
P19060	60 x 45 x 38	1
P19090	90 x 45 x 38	1
P19120	120 x 45 x 38	1

Adjustable in tilt and height to adapt to different spaces. Protect exposed foods without losing visibility.

Ajustable en inclinación y altura para adaptarse a diferentes espacios. Protege los alimentos expuestos sin perder visibilidad.

Hauteur et inclinaison réglables pour s'adapter à tous les espaces des buffets. Protège et laisse visible les aliments exposés.

### MBA92821 Mobile Acrylic Breath Guards Protección acrílica Anti-aliento Pare-haleine mobiles en acrylique



Bolsa de nylon incluida.  
Nylon bag included.  
Sac en nylon compris.  
Nylontasche nicht enthalten.



REF	W x D x H cm	
MBA92821	121,9 x 49,5 x 40,6	1

Convenient, durable and portable solution to cover food serving areas. Folds down flat and secures with magnetic latches - for ease in transporting. 1 cm thick acrylic panels can be securely fastened in place with easy thumb turns.

Solución para cubrir superficies de alimentos. Paneles acrílicos de 1 cm de grosor. Duradero. De fácil montaje y transporte.

Solution pratique, durable et portable pour couvrir les zones de service des aliments.

## Protection and covers 14.2

Protección y tapas  
Protection et couvercles

### P590008 Dome cover Tapa campana Couvercle cloche



REF	Ø cm	H cm	
P590008	21	17,5	1
P590009	26	20,0	1
P590010	31	23,5	1



Fitting system with the base that provides stability

Sistema de encaje con la base que aporta estabilidad

Système d'assemblage avec la base qui assure la stabilité

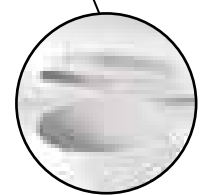

### P22361 Display tray Bandeja presentación Plateau présentation



REF	Ø cm	H cm	
P22361	22,7	1,5	1
P22362	27,8	1,5	1
P22363	32,7	1,5	1

### P2236 Stand Stan Base



Suitable for  
Combinable con

Adaptable pour  
P22361 / P22362 / P22363

REF	Ø cm	H cm	
P22366	16,5	10	1
P22367	16,5	18	1

### P590011 Hinged cover Tapa con visagra Couvercle articulé



REF	Ø cm	
P590011	23,0	1
P590012	26,5	1

### P22364 Bowl Bol Bol



REF	Ø cm	
P22364	22,5	1
P22365	26,0	1



IDEA! P590008 + P22361  
P590009 + P22362  
P590010 + P22363



IDEA! P590011 + P22364  
P590012 + P22365

## 14.2 Protection and covers

Protección y tapas  
Protection et couvercles



**P598700** Clear round lid for presentation  
*Tapa redonda transparente presentación*  
Couvercle rond transparent pour présentation



REF	Ø cm	H cm	
P598700	22	13,5	1
P598800	27	16,5	1

**P590005** Round display cabinet  
*Vitrina redonda*  
Vitrine ronde



REF	Ø cm	H cm	Base útil / Functional basic Base utile Ø cm	
P590005	38	22	31,5	1
P590006	46	26	37,5	1

**P590001** Rectangular display cabinet  
*Vitrina rectangular*  
Vitrine rectangulaire



REF	W x D x H cm	Base útil / Functional basic Base utile Ø cm	
P590001	40 x 24,5 x 15,5	34 x 19	1
P590002	50,5 x 30,5 x 18	44 x 24,5	1

**P590003** Double display cabinet  
*Vitrina doble*  
Vitrine double



REF	W x D x H cm	Base útil / Functional basic Base utile Ø cm	
P590003	40 x 24,5 x 32	2 x (34 x 19)	1
P590004	50,5 x 30,5 x 40	2 x (44 x 24,5)	1

## Protection and covers 14.2

Protección y tapas  
Protection et couvercles



**P904300** Roll-top lid  
*Tapa roll-top*  
Couvercle roll-top

1/1



REF	Mod	W x D x H cm	
P904300	1/1	57 x 32,5 x 17,5	1

**P590110** Clear GN lids for presentation  
*Tapas GN transparentes presentación*  
Couvercles GN transparentes de présentation



**P834** GN prectangular lid  
*Tapa rectangular GN*  
Couvercle rectangulaire GN

1/1

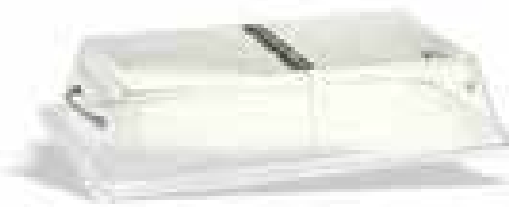

REF	Mod	W x D x H cm	
P834000	1/1	53 x 32,5 x 10	6

**P835** GN dome lid  
*Campana GN*  
Dôme de protection GN

1/1



REF	Mod	W x D x H cm	
P835000	1/1	53 x 32,5 x 19	6

Suitable for  
*Compatible con / Adaptable pour*

P. 391



P. 391



P. 351



P. 378





## 14.3 Bronze cookware

Batería cocina bronce  
Batterie de cuisine bronze

NEW!

Transparent glass lid with stainless steel rim and black handle.

Tapa de cristal transparente con borde de acero inoxidable y mango en color negro.

Couvercle en verre transparent avec rebord en acier inoxydable et manche noir.

Escape valve for steam

Válvula de salida de vapor  
Clapet de sortie de la vapeur

Exterior painted in an elegant bronze colour.

Exterior pintado en elegante color bronce.

Extérieur avec revêtement bronze élégant.

Made of cast aluminium with high resistance to deformation and excellent thermal performance.

Fabricada en aluminio de fundición de gran resistencia a la deformación y con excelentes prestaciones térmicas.

Fabriqué en fonte d'aluminium très résistante à la déformation et doté d'excellentes performances techniques.

Ground base

Fondo torneado  
Fond dressé

## Elegant, robust, versatile

Elegante, robusta, versátil / Élégante, solide, polyvalente



CA  
Cast  
Aluminum

NEW!



## Bronze cookware 14.3

Batería cocina bronce  
Batterie de cuisine bronze

**P1520** Rotisserie  
Rustidera  
Plat à rôtir



REF	W x D x H cm	
P152035B	35 x 25 x 7,5	1
P152935	Transparent lid Tapa transparente / Couvercle transparent	1

**P1410** Shallow casserole without lid  
Cazuela baja sin tapa  
Cocotte sans couvercle



REF	Ø cm	H cm	
P141024B	24	5,8	1
P141028B	28	7,5	1
P141032B	32	8,0	1

**P1510** Deep casserole without lid  
Cazuela alta sin tapa  
Braising sans couvercle



REF	Ø cm	H cm	
P151020B	20	9	1
P151024B	24	10	1
P151028B	28	12	1

**P1540** Glass lid with stainless steel rim  
Tapa de cristal con borde de acero inoxidable  
Couvercle en verre avec rebord en acier inoxydable

Cr  
Crystal



REF	Ø cm	
P154020	20	1
P154024	24	1
P154028	28	1
P154032	32	1

# 14.4 Cool-line

**P1311** Enamelled steel GN container  
 Cubeta GN de acero esmaltado  
 Bac GN en acier émaillé



Suitable for all types of temperature-maintaining plates.  
 Apto para todo tipo de placa mantenedora de temperatura.  
 Convient à tous types de plaques de maintien en température.



P131165



P131120



REF	Type Tipo	H cm	☐
P131120	1/1	2,0	1
P131165	1/1	6,5	1
P131220	1/2	2,0	1
P131265	1/2	6,5	1

**P4909** Paella pan with lid  
 Paellera con tapa  
 Plat à paella avec couvercle

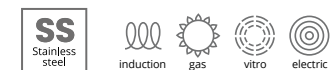

**EXCLUSIVE**



Ref. colour / Ref. color / Ref. couleur couvercle



REF	Ø cm	H cm	Lts	☐
P490928 + COLOR	28	6	3,7	1
P490932 + COLOR	32	6	4,7	1

See products on  
 Ver productos en / Voir produits en page **P. 54**

**Cookware**  
 Batería de cocina  
 Batterie de cuisine



See products on  
 Ver productos en / Voir produits en page **P. 71**

**Fry pans**  
 Sartenes  
 Poêles



# Cool-line 14.4



**P1106F3** Non-stick sandwich bottom GN container  
 Cubeta GN antiadherente con fondo difusor  
 Bac GN anti-adhésive avec fond thermo-diffuseur

**PATENTED EXCLUSIVE**

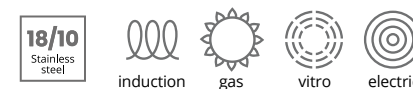

**IDEAL** Ideal for buffet presentations.  
 Ideal para presentación buffet.  
 Idéal pour présentation buffet.

Ref	Type Tipo	H mm	Lts	☐
P1106F3A	1/1	6,5	8,30	1
P1106F3N	1/1	6,5	8,30	1
P1106F3R	1/1	6,5	8,30	1
P1106F3G	1/1	6,5	8,30	1
P1106F3	1/1	6,5	8,30	1
P1206F3A	1/2	6,5	4,10	1
P1206F3N	1/2	6,5	4,10	1
P1206F3R	1/2	6,5	4,10	1
P1206F3G	1/2	6,5	4,10	1
P1206F3	1/2	6,5	4,10	1

P1106F3A



P1106F3R



P1106F3



Ref. colour / Ref. color / Ref. couleur couvercle



P1106F3N



P1106F3G



# 14.5 Super shapes

Buffet presentation steam table pans

Cubetas presentación buffet / Bacs présentation buffet



**PATENTED** **EXCLUSIVE**

Presentation of food in chafers, heated or refrigerated buffet lines, display cases, and more.

Presentación de las comidas en chafers, líneas buffet calientes o fríos, vitrinas de presentación y más.

Présentation des plats dans les chafers, les lignes de buffet chauffées ou réfrigérées, les présentoirs et bien plus encore.

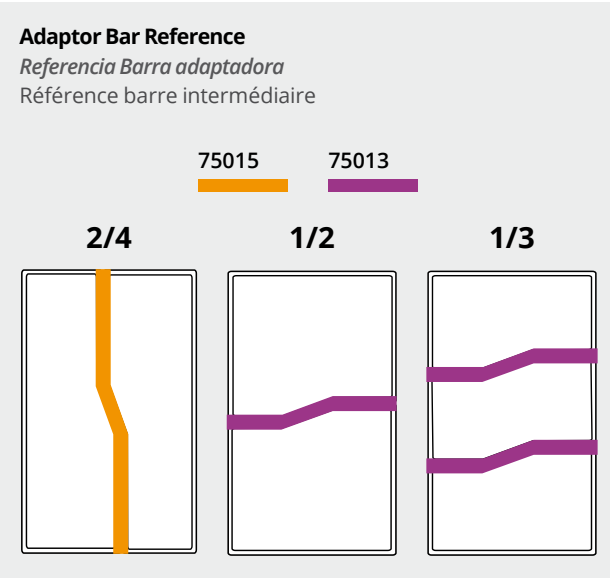

Stackable  
Apilable  
Empilable



# Super shapes 14.5

Buffet presentation steam table pans

Cubetas presentación buffet / Bacs présentation buffet



**3101015 Full Oval**  
Ovalada  
Ovale



1/1



REF	W x D x H cm	L	☐
3101015	53 x 32,5 x 5,1	3,7	6
3101020	53 x 32,5 x 6,5	4,6	6
3101040	53 x 32,5 x 10	7,8	6

**3102015 Half Oval**  
Óvalo  
Ovale



1/2



REF	cm	L	☐
3102015	26,5 x 32,5 x 5,1	1,6	6
3102020	26,5 x 32,5 x 6,5	2,1	6
3102040	26,5 x 32,5 x 10	3,5	6

**3101220 Full Hexagon**  
Hexágono  
Hexagonal



1/1



REF	W x D x H cm	L	☐
3101220	53 x 32,5 x 6,5	5,0	6
3101240	53 x 32,5 x 10	8,8	6

**3102220 Full Hexagon**  
Hexágono  
Hexagonal



1/2



REF	W x D x H cm	L	☐
3102220	26,5 x 32,5 x 6,5	2,1	6

**3101120 Full Kidney**  
Reniforme  
Rein



1/1



REF	W x D x H cm	L	☐
3101120	53 x 32,5 x 6,5	4,8	6

# 14.5 Super shapes

## Buffet presentation steam table pans

Cubetas presentación buffet / Bacs présentation buffet



**3102120** Half Kidney  
Reniforme  
Rein



1/2



REF	W x D x H cm	L	
3102120	26,5 x 32,5 x 6,5	2,1	6

**3100020** Long Wild Pan  
Wild Pan larga  
Wild Pan long



2/4



75015

REF	W x D x H cm	L	
3100020	53 x 16,5 x 6,5	3,5	6
3100040	53 x 16,5 x 8,9	4,8	6

**3100220** Short Wild Pan  
Wild Pan corta  
Wild Pan court



1/2



75013

REF	W x D x H cm	L	
3100220	26,5 x 32,5 x 6,5	3,9	6
3100240	26,5 x 32,5 x 10	6,1	6

**3100320** Third Outer Wild Pan  
Wild Pan externa  
Troisième Wild Pan extérieur



1/3



75013

REF	W x D x H cm	L	
3100320	17,6 x 32,5 x 6,5	2,5	6
3100340	17,6 x 32,5 x 10	3,6	6

**3100321** Inner Wild Pan  
Wild Pan interna  
Troisième Wild Pan intérieur



1/3



75013

REF	W x D x H cm	L	
3100321	17,6 x 32,5 x 6,5	2,5	6
3100341	17,6 x 32,5 x 10	3,6	6

**75015** Adaptor Bar  
Barra adaptadora  
Barre intermédiaire



REF	For / Para / Pour	
75015	3100020 / 3100040	12
75013	3100220 / 3100240 / 3100320 3100321 / 3100340 / 3100341	12

See products on / Ver productos en / Voir produits en page

P. 194



See products on / Ver productos en / Voir produits en page

P. 203



BUFFET & ACCESSOIRES  
BUFFET / ACCESSORIOS  
BUFFET / ACCESSOIRES

## 14.6 Miramar® cookware

Batería de cocina para presentación  
Batterie de cuisine-Présentation



Cookware goes straight from the kitchen to your buffet in the same vessel.

Variety of cookware items or any menu.

*La batería pasa directamente de la cocina a su buffet en el mismo recipiente.*

*Variación de utensilios de cocina para todo tipo de comidas.*

Passez directement de la cuisine au buffet sans changer de plat.  
Variété d'articles pour tout type de menu.

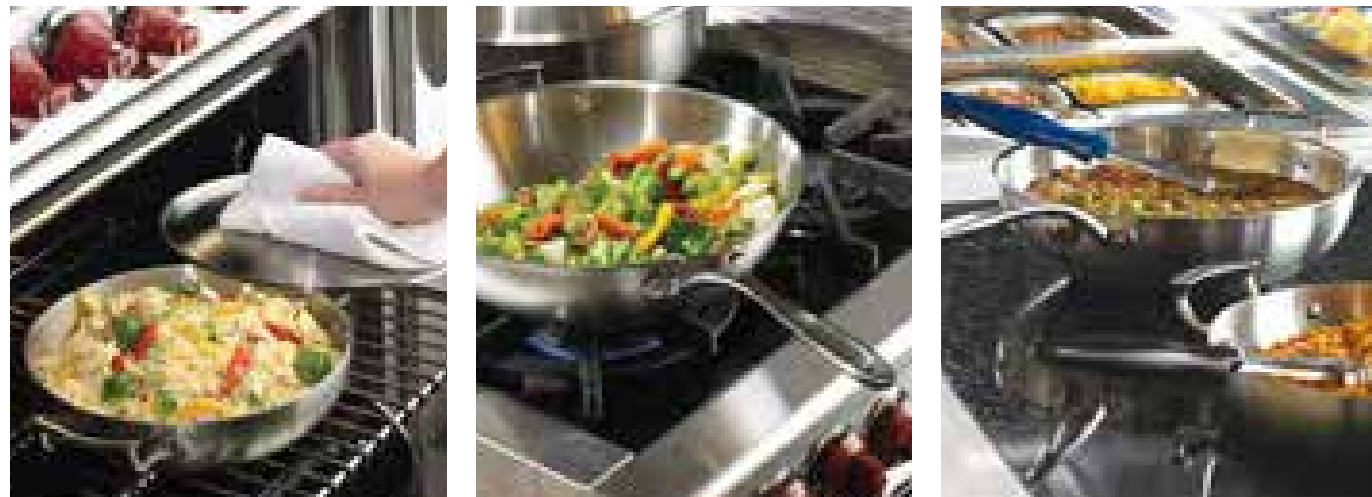

## Miramar® cookware 14.6

Batería de cocina para presentación  
Batterie de cuisine-Présentation



**Satin-finished interior and exterior**

*Asas y mangos brillantes*  
*Des poignées ultra-brillantes*

**Handle design serves as a convenient cover rest**

*Mangos diseñados para la sujeción de las tapas*  
*La conception des manches et poignées sert de reposecouvrerle*

**Mirror-finished handles**

*Interior y exterior satinados*  
*Finition satinée à l'intérieur et l'extérieur*

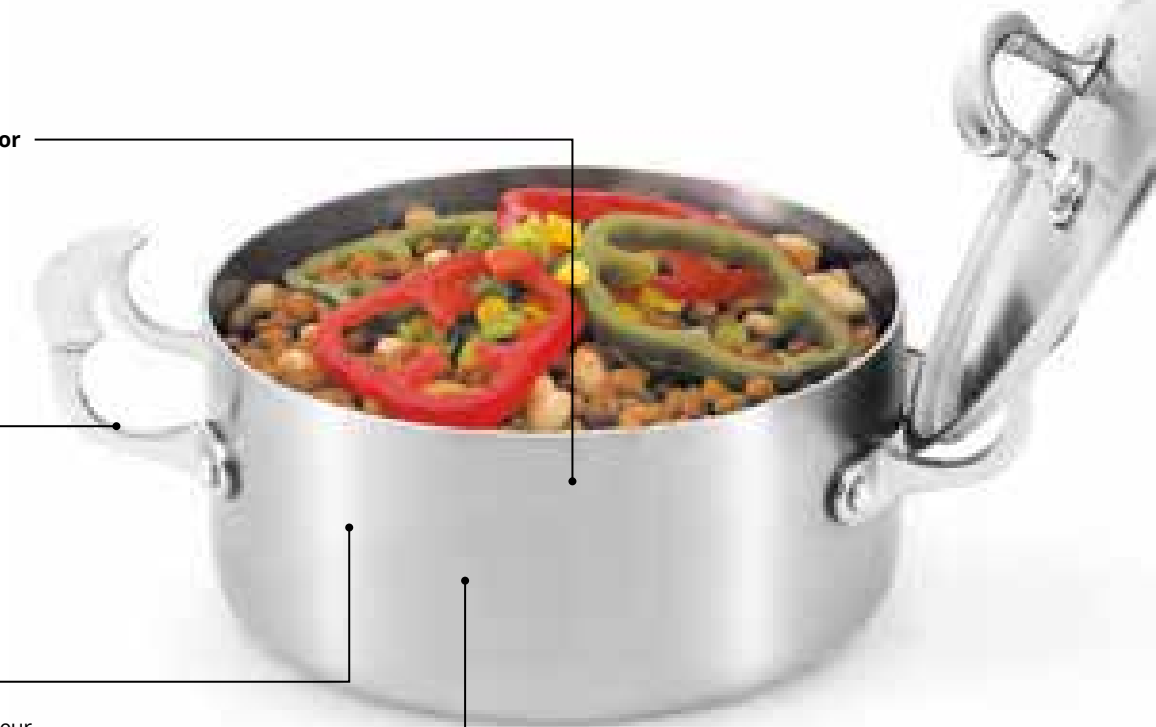

**Multi-ply**  
*Multimetal*  
*Multi-metal*

**St/Steel - Inox**

**Tri-aluminium**

**St/Steel - Inox**

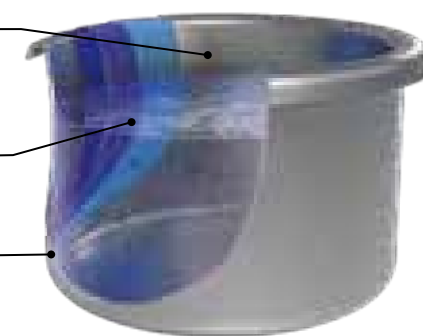

# 14.6 Miramar® cookware

Batería de cocina para presentación  
Batterie de cuisine-Présentation



**49410 Casseroles**  
Cacerola baja con tapa  
Faitouts avec couvercle dôme bas



REF	Ø cm	H cm	L	
49410	20,0	9,5	2,9	1
49411	24,1	11,3	4,8	1
49441	25,8	18,9	6,6	1 <b>NEW</b>

**49425 Bazier pan**  
Cacerola baja  
Plat à braiser



REF	Ø cm	H cm	L	
49425	30	8,9	6	1

**49413 Sauté Pan**  
Sartén  
Sauteuse



REF	Ø cm	H cm	L	
49416	20,3	5,1	1,2	1 <b>NEW</b>
49413	26,0	4,8	2,1	1

**49417 French Omelet Pans**  
Paellera  
Poêle à omelette



REF	cm	H cm	L	
49417	20,3 x 20,3	6	1,7	1
49424	26 x 26	6	2,9	1

**49418 Stir Fry Pan**  
Sautex bombeado  
Wok/plat de service



REF	Ø cm	H cm	L	
49418	30,2	9,4	4,9	1
49428	32,1	9,2	6,0	1

**49430 Sauce Pans**  
Cazo  
Casserole



REF	Ø cm	H cm	L	
49414	15,9	9,5	1,9	1
49430	14,0	6,8	0,9	1 <b>NEW</b>

# Miramar® cookware 14.6

Batería de cocina para presentación  
Batterie de cuisine-Présentation



**49434 Food Pans**  
Fuente  
Plat



REF	W x D x H cm	L	
49432	37,3 x 30 x 5,1	4,4	1 <b>NEW</b>
49435	29,1 x 23,6 x 5,1	2,6	1
49433	37,3 x 30 x 5,1	4,4	1

**49431 French Oven with cover**  
Fuente Horno con tapa  
Cocotte avec couvercle



REF	W x D x H cm	L	
49431	363 x 282 x 9,7	6,6	1

**8230210 Oval presentation dish**  
Fuente presentación ovalada  
Fontaine de présentation ovale



REF	W x D x H cm	L	
8230210	33,3 x 22,5 x 6,4	1,9	1
8231420	48,4 x 30,2 x 5,1	2,8	1

**49420 Oval Au Gratin**  
Fuente para gratinar  
Plat à gratin ovale



\* Mirror-finished interior  
Acabado brillante  
Ultra-brillant

REF	W x D x H cm	L	
49420	25,4 x 19,1 x 5,2	1,7	1
49412*	30,5 x 21,6 x 5,1	2,5	1
49442	40,6 x 22,9 x 5,1	3,5	1 <b>NEW</b>
49445	52,3 x 22,9 x 10,2	6,6	1 <b>NEW</b>

**49429 Covers**  
Tapa  
Couvercles



REF	For / Para / Pour	Ø cm	H mm	
49429	49428	35,6	120	1
49426	49418 - 49425	32,4	102	1
49419	49416 - 49417	20,3	51	1
49423	49413 - 49424	27,3	51	1
49427	49430	14,9	51	1 <b>NEW</b>

**8231810 Rectangular presentation dish**  
Fuente presentación rectangular  
Fontaine de présentation rectangulaire



REF	W x D x H cm	L	
8231810	33,2 x 27 x 2,5	1,5	1
8230720	33,2 x 27 x 7	3,2	1

# 14.6 Miramar® cookware

Batería de cocina para presentación  
Batterie de cuisine-Présentation

TEMPLATES  
PLANTILLAS  
GABARITS

Stainless Steel Plain / Acero inox. / Inox  
Resin / Resina / Résine  
Night Sky / Negro / Bleu nuit

+150°C



**8242014** One large and one small round  
Plantilla agujeros redondo grande y pequeño  
Une grande découpe ronde et une petite découpe ronde



REF	cm		
8242014	53,6 x 32,4		1
8242010	53,6 x 32,4		1

**8242314** One large oval  
Plantilla agujero oval grande  
Une grande découpe ovale



REF	cm		
8242314	53,6 x 32,4		1
8242310	53,6 x 32,4		1

**8242414** One large round and one small round  
Plantilla agujeros redondo grande y pequeño  
Une grande découpe ronde et une petite découpe ronde

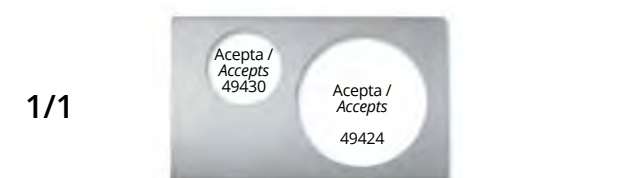

REF	cm		
8242414	53,6 x 32,4		1

**8242514** Two large round  
Plantilla agujeros redondos grandes  
2 grandes découpes rondes



REF	cm		
8242514	53,6 x 32,4		1

**8242614** One large round  
Plantilla agujero redondo grande  
Une grande découpe ronde



REF	cm		
8242614	53,6 x 32,4		1
8242610	53,6 x 32,4		1

**8242714** One large oval  
Plantilla agujero oval grande  
Un grand ovale



REF	cm		
8242714	53,6 x 32,4		1
8242710	53,6 x 32,4		1

# Miramar® cookware 14.6

Batería de cocina para presentación  
Batterie de cuisine-Présentation

+150°C

**8240016** Solid baseplate  
Plantilla sólida  
Modèle solide



1/1



REF	cm		
8240016	53,6 x 32,4		1

**8242814** One small food pan  
Plantilla para fuente  
Un petit bac à aliments

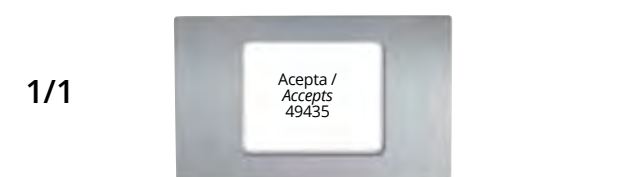

REF	cm		
8242814	53,6 x 32,4		1
8242810	53,6 x 32,4		1

**8242914** One large food pan  
Plantilla para fuente  
Un grand bac à aliments

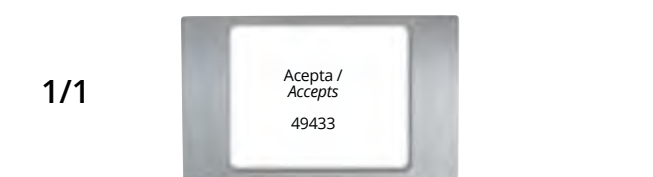

REF	cm		
8242914	53,6 x 32,4		1

**8243014** Two small food pans  
Plantilla para fuente  
Deux petits bacs à aliments

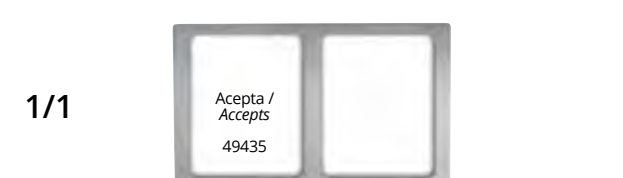

REF	cm		
8243014	53,6 x 32,4		1

**8243114** One large and one medium oval  
Plantilla agujeros ovales grande y pequeño  
Une grande découpe ronde et une moyenne découpe ovale



REF	cm		
8243114	53,6 x 32,4		1

**8243214** Two medium oval  
Plantilla agujeros redondos medianos  
Deux découpes ovales moyennes



REF	cm		
8243214	53,6 x 32,4		1
8243210	53,6 x 32,4		1

**8243314** One large and one medium round  
Plantilla agujeros redondos grande y mediano  
Une grande découpe ronde et une moyenne découpe ronde



REF	cm		
8243314	53,6 x 32,4		1

# 14.7 CUBIC®

**EXCLUSIVE**  
PATENT PENDING

**Modularity that reflects maximum expression**

*Modularidad a la máxima expresión*

*Modularité à son expression maximale*

**Discover the best buffet display, thanks to its:**

- It allows to optimize exhibition space
- It reduces assembly and disassembly time
- Ease of transport and storage
- Elegant and original
- It offers multiple and varied combinations

**Descubre la mejor presentación de buffet, porque:**

- Permite optimizar espacio de exposición
- Reduce el tiempo de montaje y desmontaje
- Facilidad de transporte y almacenaje
- Elegante y original
- Ofrece múltiples y variadas combinaciones

**Découvrez la meilleure présentation buffet, grâce à son :**

- Permet d'optimiser l'espace d'exposition
- Réduit le temps de montage et de démontage
- Facilité de transport et de stockage
- Élégant et original
- Offre des combinaisons multiples et variées



**CUBES / CUBO / CUBES**  
Top cover convertible on mini shelf, stackable, multicombinations, saving space when storing parts, special waterproof treatment.

*Con tapa superior transformable en mini estante, apilables entre sí, múltiples combinaciones posibles, ahorro de espacio durante el almacenaje de las piezas, tratamiento hidrófugo especial.*

Couvercle transformable en mini rayon, empilables, multiples combinaciones posibles, gain d'espace pour le stockage des composants, traitement hydrofuge spécial.

**SHELVES / ESTANTES / TABLETTES**  
Three lengths: 50, 80 and 100 cm, two depths: 18 and 35 cm, undeformable wood. Special waterproof treatment.

*Tres longitudes: 50, 80 y 100 cm, dos profundidades: 18 y 35 cm, madera indeformable. Tratamiento hidrófugo especial.*

Trois longueurs: 50, 80 et 100 cm, deux profondeurs: 18 et 35 cm. Bois indéformable. Traitement hydrofuge spécial.

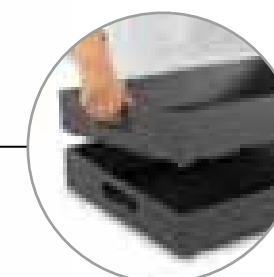
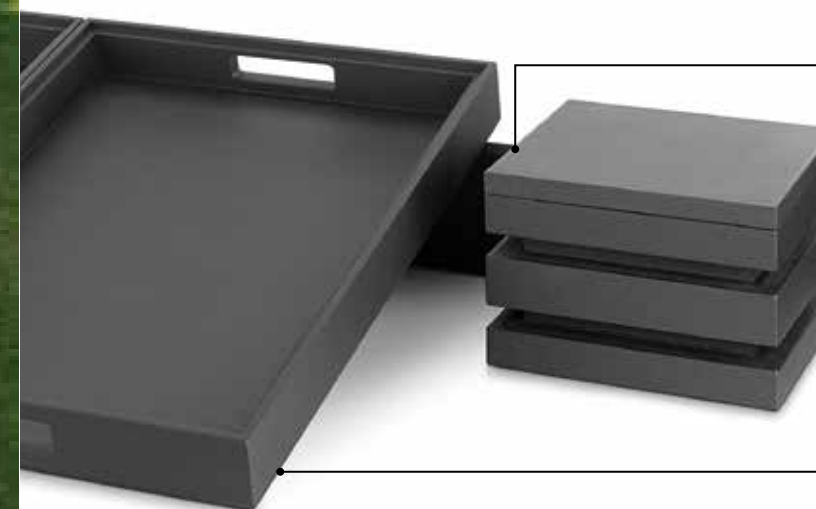
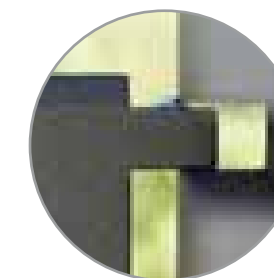
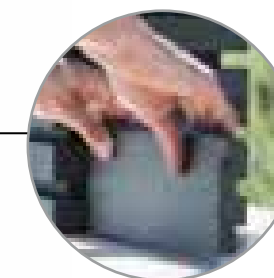

**Stackable trays**  
*Bandejas apilables entre sí*  
*Plateaux empilables entre eux*



## Display buffet cases Muebles presentación buffet Meubles présentation buffet

**Suitable for gastronorm sizes**  
Adaptado a medidas gastronorm  
Adaptés aux mesures gastronorme

**Made of wood with special waterproof treatment, easy to clean**

Fabricados en madera con tratamiento hidrófugo especial, de fácil limpieza

Fabriqué en bois avec un traitement hydrofuge spécial, facile à nettoyer



## Wooden buffet serving trolley Carro madera presentación buffet Chariot buffet en bois présentation buffet

**Outstanding combination of wood and aluminium**  
Elegante combinación de madera y aluminio  
Combinaison élégante en bois et en aluminium

**Suitable for gastronorm sizes**  
Adaptado a medidas gastronorm  
Adaptés aux mesures gastronorme

**Possible transformation from an expositor trolley to a presentation table**

Posibilidad de convertir el carro expositor en mesa de presentación

Possibilité de transformer le chariot d'exposition en une table de présentation

**Wood with special waterproof treatment, easy to clean**  
Tratamiento hidrófugo especial, de fácil limpieza  
Bois avec un traitement hydrofuge spécial, facile à nettoyer



**P905504** Presentation kit for 4 square bowls  
Conjunto soporte 4 bols cuadrados  
Kit support 4 bols carrés

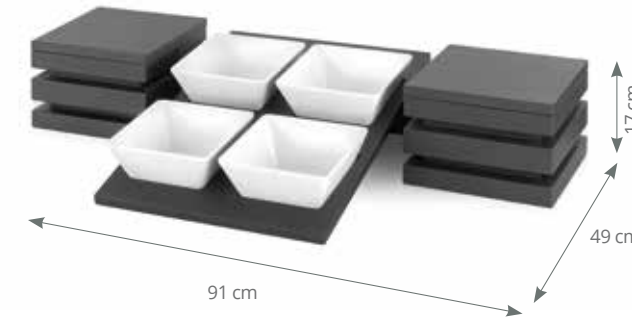

**Includes :**  
2 cubes with lid  
1 crossbar 50 cm  
length  
1 displayer for 4 bowls  
4 melamine bowls.

**Incluye:**  
2 cubos con tapa  
1 travesaño de 50 cm  
1 presentador de 4 bols  
4 bols de melamina.

**Inclus :**  
2 cubes avec couvercle  
1 longeron 50 cm  
1 présentoir pour 4 bols  
4 bols mélamine.

REF P905504  1

**P905506** Presentation kit for 6 square bowls  
Conjunto soporte 6 bols cuadrados  
Kit support 6 bols carrés

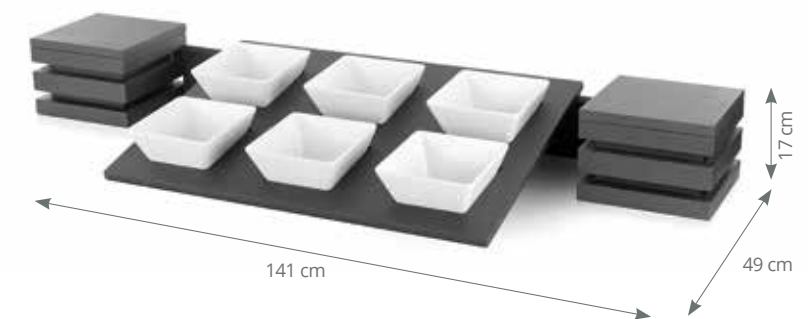

**Includes :**  
2 cubes with lid  
1 crossbar 100 cm  
length  
1 displayer for 6 bowls  
6 melamine bowls.

**Incluye:**  
2 cubos con tapa  
1 travesaño de 100 cm  
1 presentador de 6 bols  
6 bols de melamina.

**Inclus :**  
2 cubes avec couvercle  
1 longeron 100 cm  
1 présentoir pour 6 bols  
6 bols mélamine.

REF P905506  1

**P905516** Two levels presentation kit for 6 square bowls  
Conjunto 2 niveles soporte 6 bols  
Kit support 6 bols carrés deux niveaux

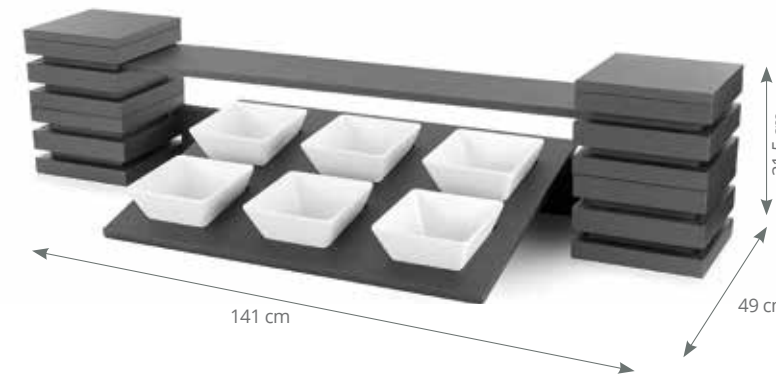

**Includes :**  
4 cubes with lid  
1 crossbar 100 cm  
length  
1 displayer for 6 bowls  
6 melamine bowls  
1 narrow shelf 100 cm

**Incluye:**  
4 cubos con tapa  
1 travesaño de 100 cm  
1 presentador de 6 bols  
6 bols de melamina  
1 estante estrecho de 100 cm

**Inclus :**  
4 cubes avec couvercle  
1 longeron 100 cm  
1 présentoir pour 6 bols  
6 bols mélamine  
1 tablette étroite 100 cm

REF P905516  1

**P905508** Presentation kit for 8 square bowls  
Conjunto soporte 8 bols cuadrados  
Kit support 8 bols carrés

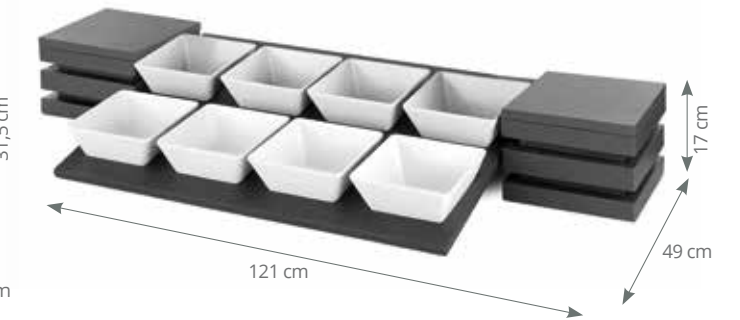

**Includes :**  
2 cubes with lid  
1 crossbar 80 cm  
length  
2 displayers for 4 bowls  
8 melamine bowls

**Incluye:**  
2 cubos con tapa  
1 travesaño de 80 cm  
2 presentadores de 4 bols  
8 bols de melamina

**Inclus :**  
2 cubes avec couvercle  
1 longeron 80 cm  
2 présentoirs pour 4 bols  
8 bols mélamine

REF P905508  1

## P905518 Two levels presentation kit for 8 square bowls

Conjunto 2 niveles soporte 8 bols  
Kit support 8 bols carrés deux niveaux

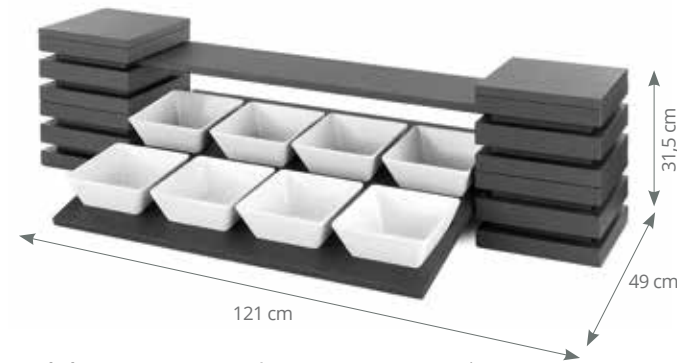

<b>Includes :</b>	<i>Incluye:</i>	<b>Inclus :</b>
4 cubes with lid	4 cubos con tapa	4 cubes avec couvercle
1 crossbar 80 cm length	1 travesaño 80 cm	1 longeron 80 cm
2 displayers for 4 bowls	2 presentadores de 4 bols	2 présentoirs pour 4 bols
8 melamine bowls	8 bols de melamina	8 bols mélamine
1 narrow shelf 80 cm	1 estante estrecho 80 cm	1 tablette étroite 80 cm

REF 1  
P905518

## P905400 Basic two levels presentation kit

Conjunto básico estante 2 niveles

Kit basique présentation 2 niveaux



<b>Includes :</b>	<i>Incluye:</i>	<b>Inclus :</b>
4 cubes with lid	4 cubos con tapa	4 cubes avec couvercle
1 wide shelf 100 cm	1 estante ancho 100 cm	1 tablette large 100 cm
1 narrow shelf 100 cm	1 estante estrecho 100 cm	1 tablette étroite 100 cm

REF 1  
P905400

## P905310 Two levels presentation kit for 40x40 cm trays

Conjunto 2 niveles bandejas 40x40 cm  
Kit présentation 2 niveaux pour plateaux 40x40 cm



<b>Includes :</b>	<i>Incluye:</i>	<b>Inclus :</b>
6 cubes with lid	6 cubos con tapa	6 cubes avec couvercle
1 crossbar 100 cm length	1 travesaño de 100 cm	1 longeron 100 cm
2 serving trays 40 x 40 cm	2 bandejas presentación de 40 x 40 cm	2 plateaux présentation 40 x 40 cm
1 narrow shelf 100 cm	1 estante estrecho de 100 cm	1 tablette étroite 100 cm

REF 1  
P905310

## P905320 Two trays 60x40 cm presentation kit

Conjunto 2 bandejas 60x40 cm  
Kit présentation pour deux plateaux 60x40 cm



<b>Includes :</b>	<i>Incluye:</i>	<b>Inclus :</b>
2 cubes with lid	2 cubos con tapa	2 cubes avec couvercle
1 crossbar 100 cm length	1 travesaño de 100 cm	1 longeron 100 cm
2 serving trays 60 x 40 cm	2 bandejas presentación de 60 x 40 cm	2 plateaux présentation 60 x 40 cm

REF 1  
P905320

## P905410 "L" shape two levels presentation kit

Conjunto estante dos niveles forma "L"  
Kit présentation "L" 2 niveles

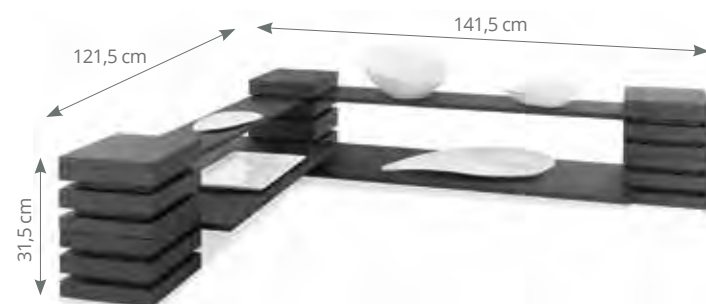

<b>Includes :</b>	<i>Incluye:</i>	<b>Inclus :</b>
6 cubes with lid	6 cubos con tapa	6 cubes avec couvercle
1 wide shelf 100 cm	1 estante ancho 100 cm	1 tablette étroite 100 cm
1 narrow shelf 100 cm	1 estante estrecho 100 cm	1 tablette étroite 100 cm
1 wide shelf 80 cm	1 estante ancho 80 cm	1 tablette large 80 cm
1 narrow shelf 80 cm	1 estante estrecho 80 cm	1 tablette étroite 80 cm

REF 1  
P905410

## P905300 Two trays 40x40 cm presentation kit

Conjunto 2 bandejas presentación 40x40 cm  
Kit présentation pour deux plateaux 40x40 cm



<b>Includes :</b>	<i>Incluye:</i>	<b>Inclus :</b>
4 cubes with lid	4 cubos con tapa	4 cubes avec couvercle
1 crossbar 100 cm length	1 travesaño de 100 cm	1 longeron 100 cm
2 serving trays 40 x 40 cm	2 bandejas presentación de 40 x 40 cm	2 plateaux présentation 40 x 40 cm

REF 1  
P905300

## P905340 Two levels for trays 60x40 cm presentation kit

Conjunto 2 niveles para bandejas 60x40 cm  
Kit présentation 2 niveles pour plateaux 60x40 cm

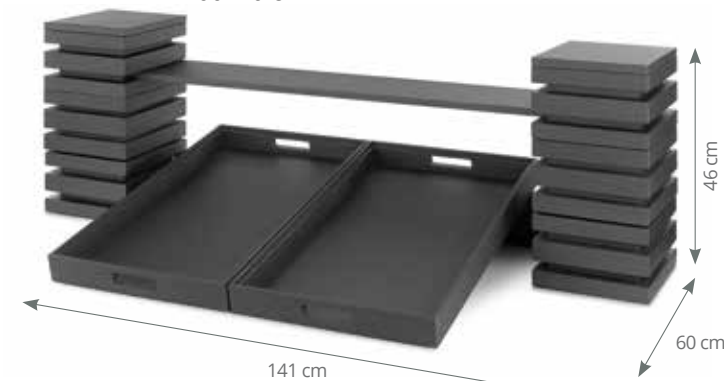

<b>Includes :</b>	<i>Incluye:</i>	<b>Inclus :</b>
6 cubes with tapa	6 cubos con tapa	6 cubes avec couvercle
1 travesaño de 100 cm	1 travesaño de 100 cm	1 longeron 100 cm
2 bandejas presentación de 60 x 40 cm	2 bandejas presentación de 60 x 40 cm	2 plateaux présentation 60 x 40 cm
1 estante estrecho de 100 cm	1 estante estrecho de 100 cm	1 tablette étroite 100 cm

REF 1  
P905340

## P904790 Three levels 2/3 GN stand

Expositor GN 2/3, tres niveles  
Présentoir 3 niveaux pour GN 2/3



**Includes / Incluye / Inclus :**  
3 GN containers 2/3 20 mm  
3 cubetas GN 2/3 20 mm  
3 bags GN 2/3 20 mm

REF **W x D x H cm** 1  
P904790 65 x 38 x 59

**P904350** GN skewer serving tray  
Bandeja GN presentación pinchos  
Plateau GN présentation piques



GN 1/1

**Includes:**  
wooden tray  
oak melamine tray  
interior skewer stand

*Incluye:*  
bandeja madera  
bandeja melamina roble  
soporte interior pinchos

**Inclus:**  
plateau bois  
plateau mélamine chêne  
support intérieur piques

REF	W x D x H cm	Holes Agujeros Ø cm	Piques Pinchos	
P904350	53,9 x 33,5 x 7,7	0,4	84	1

**P904155** Buffet wine cooler  
Enfriador botellas buffet  
Rafraîchisseur bouteilles



GN 1/1

**Includes:**  
wooden tray  
1/1 GN pan 150 mm

*Incluye:*  
bandeja madera  
cubeta GN 1/1 150 mm

**Inclus:**  
plateau bois  
bac GN 1/1 150 mm

REF	W x D x H cm	
P904155	57 x 37 x 14,5	1

**P904850** 1/1 GN wooden table + cutting board  
Mesita buffet GN 1/1 + taco madera  
Table GN 1/1 en bois + planche à découper



REF	W x D x H cm	
P904850	53 x 32,5 x 12	1

**P904810** Low wooden table + cutting board  
Mesita buffet baja + taco madera  
Table basse en bois + planche à découper



REF	W x D x H cm	
P904810	32,5 x 22 x 12	1
P904820	32,5 x 22 x 16,5	1

**P904804** Cutting board for wooden table  
Taco madera para mesita buffet  
Planche à découper pour table en bois



P904804

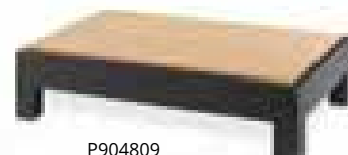

P904809

REF	W x D x H cm	
P904804 <sup>1</sup>	29,2 x 18,7 x 22	1
P904809 <sup>2</sup>	49,7 x 29,2 x 22	1

(1) For / Para / Pour P904810 / P904820  
(2) For / Para / Pour P904850

**P904720** Napkin and tea & sugar bags dispenser  
Servilletero y dispensador bolsas te y azúcar  
Distributeur serviettes et des saquettes  
thé & sucre



P904720



P904725

REF	W x D x H cm	
P904720	22 x 22 x 5,5	1
P904725	22 x 22 x 5,5	1

**P904721** Tea & sugar bag holder  
Soporte bolsas te y azúcar  
Support pour saquettes de thé & sucre



For / Para / Pour ref. P904.720

REF	W x D x H cm	
P904721	19,8 x 19,8 x 4,9	1

**P20072** Methacrylate holder  
Portamenús metacrilato  
Porte-menus méthacrylate

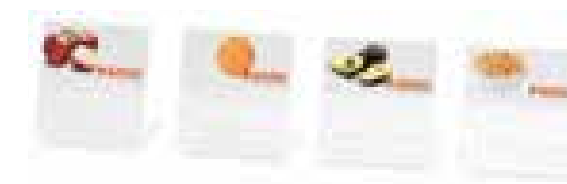

REF	cm	
P20072	6 x 6	1



See products on / Ver productos en / Voir produits en page

P. 485

**Stainless steel plate covers**  
Tapas Acero inoxidable para platos  
Inox couvercles à assiette





## ROOM SERVICE

**P904780** Cutlery-holder tray  
Bandeja porta-cubiertos  
Plateau porte-couverts



GN 1/1



Stackables.  
Apilables.  
Empilables.

4 compartments  
4 compartimentos  
4 compartiments  
303 x 115 mm

REF	W x D x H cm	
P904780	53,9 x 33,5 x 7,7	1

**P904760** Serving tray  
Bandeja servicio y presentación  
Plateau service et présentation



Stackables.  
Apilables.  
Empilables.

**IDEA!** Room service tray.  
Perfecta para servicio de habitaciones.  
Plateau idéal pour service de chambre.

REF	W x D x H cm	
P904760	60 x 40 x 6,5	1

**P904740** Serving tray  
Bandeja presentación  
Plateau présentation



Stackables.  
Apilables.  
Empilables.

REF	W x D x H cm	
P904740	40 x 40 x 6,5	1

**P904711** 1/1 GN serving tray  
Bandeja servicio y presentación GN 1/1  
Plateau service et présentation GN 1/1



GN 1/1

Stackables.  
Apilables.  
Empilables.

1/1 Gastronorm container not included.  
No incluye cubeta gastronorm 1/1.  
Bac gastronorme 1/1 non inclus.

REF	W x D x H cm	
P904711	53,9 x 33,5 x 7,7	1

**P904600** Wooden cube with lid  
Cubo con tapa madera  
Cube en bois avec couvercle

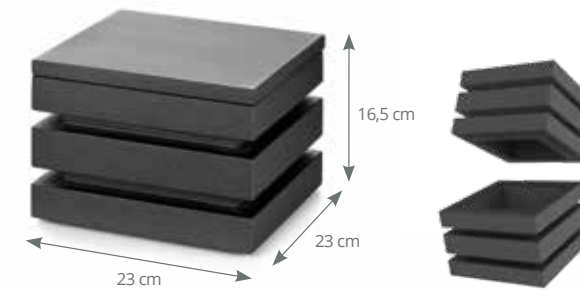

REF		
P904600		1

**P904650** Wooden narrow shelf  
Estante madera estrecho  
Tablette en bois étroite

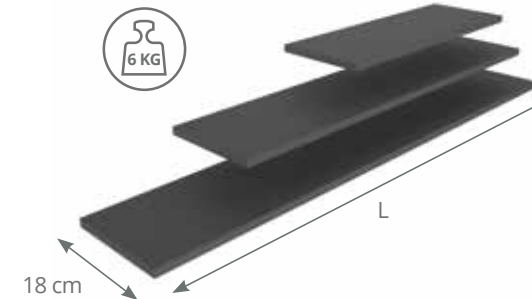

REF	L cm	
P904650	50	1
P904680	80	1
P904610	100	1

**P904937** Displayer for 4 melamine bowls  
Presentador 4 bols melamina cuadrados  
Présentoir 4 bols mélamine

For square bowls  
Para bols cuadrados  
Pour bols carrés  
180 x 180  
REF. P22.202



REF	W x D x H cm	
P904937	37,5 x 50 x 1,5	1

**P904950** Crossbar buffet trays  
Travesaño soporte bandejas  
Longerons pour plateaux buffet



**P904660** Wooden lid  
Tapa madera  
Couvercle en bois



REF		
P904660		1

**P904652** Wooden wide shelf  
Estante madera ancho  
Tablette en bois large

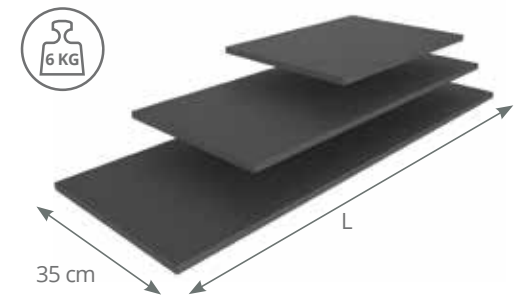

REF	L cm	
P904652	50	1
P904682	80	1
P904612	100	1

**P904975** Displayer for 6 melamine bowls  
Presentador 6 bols melamina cuadrados  
Présentoir 6 bols mélamine

For square bowls  
Para bols cuadrados  
Pour bols carrés  
180 x 180  
REF. P22.202



REF	W x D x H cm	
P904975	75 x 50 x 1,5	1

REF	W x D x H cm	
P904950	50 x 12,4 x 2	1
P904980	80 x 12,4 x 2	1
P904990	100 x 12,4 x 2	1

**P904165** Perforated buffet display  
Buffet perforado  
Buffet perforé



**Includes:** Wooden frame perforated 1/1 GN pan 65 mm gastronorm pan 1/1 20 mm roll-top lid.  
**Incluye:** Marco madera bandeja perforada GN 1/1 65 mm cubeta GN 1/1 20 mm cúpula roll-top.  
**Inclus:** Cadre en bois bac GN 1/1 65 mm perforé bac GN 1/1 20 mm couvercle roll-top

REF	W x D x H cm	
P904165	57 x 37 x 31	1

**P904113** Triple buffet display  
Buffet triple  
Buffet triple



**Includes:** Wooden frame 3 units 1/3 GN pans 65 mm GN pan 1/1 20 mm roll-top lid.  
**Incluye:** Marco madera 3 cubetas GN 1/3 65 mm cubeta GN 1/1 20 mm cúpula roll-top.  
**Inclus:** Cadre en bois 3 bacs GN 1/3 65 mm bac GN 1/1 20 mm couvercle roll-top.

REF	W x D x H cm	
P904113	57 x 37 x 31	1

**P904200** Wooden frame  
Marco madera  
Cadre en bois



**P904120** Standard buffet display  
Buffet estandar  
Buffet standard



**Includes:** Wooden frame 2u. 1/1 GN 1/1 20 mm roll-top lid.  
**Incluye:** Marco madera 2 u. cubeta GN 1/1 20 mm cúpula roll-top.  
**Inclus:** Cadre en bois 2 u. bacs GN 1/1 20 mm couvercle roll-top

REF	W x D x H cm	
P904120	57 x 37 x 31	1

**P904140** Cheese buffet display  
Buffet quesos  
Buffet fromage



**Includes:** Wooden frame wooden cutting board GN pan 1/1 20 mm roll-top lid.  
**Incluye:** Marco madera bandeja corte madera cubeta GN 1/1 20 mm cúpula roll-top.  
**Inclus:** Cadre en bois planque à découper en bois bac GN 1/1 20 mm couvercle roll-top.

REF	W x D x H cm	
P904140	57 x 37 x 31	1

REF	W x D x H cm	
P904200	57 x 37 x 14,5	1

**P904400** Isothermal mat  
Tapete isotérmico  
Tapis isotherme



REF	W x D x H cm	
P904400	47 x 26 x 20	250

**P904160** Melamine slate buffet displayer  
Buffet pizarra melamina  
Mélamine buffet ardoise



**Includes:** Wooden frame melamine slate board 1/1 GN container 20 mm.  
**Incluye:** Marco madera tabla pizarra melamina cubeta GN 1/1 20 mm.  
**Inclus:** Cadre en bois plaque ardoise en mélamine bac GN 1/1 20 mm

REF	W x D x H cm	
P904160	57 x 37 x 14,5	1

**P904146** Wooden bread cutting board  
Cortador pan madera  
Plaque à découper pain en bois

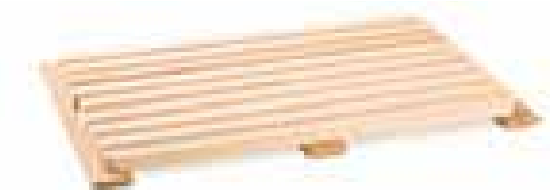

REF	W x D x H cm	
P904146	52 x 31,5 x 20	1

**P904500** Cooling plate  
Placa enfriadora  
Plaque réfrigérante



- 12 °C



Adjustable to 1/1 GN pan.  
Adaptable a cubeta GN 1/1.  
Adaptable à bac GN 1/1.

REF	W x D x H cm	
P904500	47,5 x 27,7 x 3	5

**P904145** Bread buffet display  
Buffet pan  
Buffet pain



**Includes:** Wooden frame bread cutting board 1/1 GN container 20 mm.  
**Incluye:** Marco madera cortador pan madera cubeta GN 1/1 20 mm.  
**Inclus:** Cadre en bois plaque à découper pain en bois bac GN 1/1 20 mm

REF	W x D x H cm	
P904145	57 x 37 x 14,5	1

**P904142** Wooden bread cutting board  
Cortador pan madera  
Plaque à découper pain en bois



GN 1/1

REF	W x D x H cm	
P904142	53 x 32,5 x 2	1

**EXCLUSIVE**



**BUFFET TROLLEY WITH POSSIBLE TRANSFORMATION FROM AN EXPOSITOR TROLLEY TO A PRESENTATION TABLE**  
**CARRO BUFFET CON POSIBILIDAD DE CONVERTIR EL CARRO EXPOSITOR EN MESA DE PRESENTACIÓN**  
**CHARIOT BUFFET AVEC POSSIBILITÉ DE CONVERTIR LE CHARIOT D'EXPOSITION EN UNE TABLE DE PRÉSENTATION**



**\*Two cover are included on the price**  
*\*Dos tapas incluidas en precio*  
*\*Deux tablettes comprises dans le prix*  
**P90492**

**Cover for 1/1 GN insert not included on the price**  
*Tapa individual encaje GN 1/1 no incluida en precio*  
*Tablette de bac GN 1/1 non comprise dans le prix*  
**P90493**

**P90490 Black buffet trolley for 4 1/1 GN inserts**  
*Carro buffet negro 4 GN 1/1*  
*Chariot buffet noir pour 4 bacs GN 1/1*



REF	Type / Tipo	
P90490*	4 X GN 1/1	1
P90492	Tapa / Cover / Tablette	1
P90493	Tapa / Cover / Tablette 1/1	1

**Outstanding combination of wood and aluminium**

*Elegante combinación de madera y aluminio*  
*Combinaison élégante en bois et en aluminium*



**Wood with special waterproof treatment, easy to clean**  
*Madera con tratamiento hidrófugo especial, de fácil limpieza*  
*Bois avec un traitement hydrofuge spécial, facile à nettoyer*

**Reinforcement bar**  
*Barra refuerzo nivel inferior*  
*Barre de renforcement*

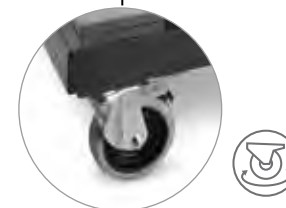

**Soundproof and revolving castors**  
**Ø 125 mm, with brakes**  
*Ruedas giratorias e insonoras de Ø 125 mm, con freno*  
*Roulettes insonores et pivotantes de Ø 125 mm, avec freins*

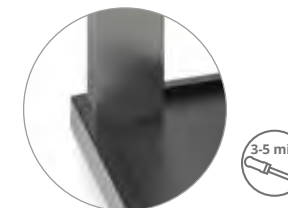

**Delivered flatpacked between 3 to 5 minutes assembly**  
*Se suministran desmontados entre 3 a 5 minutos de montaje*  
*Livrés démontés entre 3 et 5 minutes de montage*



**Suitable for gastronorm sizes**  
*Adaptado a medidas gastronorm*  
*Adapté aux mesures gastronorme*

**TREND** **Wooden-aluminium trolley 2 shelves**  
*Carro madera-aluminio 2 estanterías*  
 Chariot en bois-aluminium 2 plateaux



REF	Colour	
P80220	Negro / Black / Noir	1

**P80219** **Wooden gueridon trolley**  
*Gueridón o carro auxiliar madera*  
 Chariot guéridon en bois

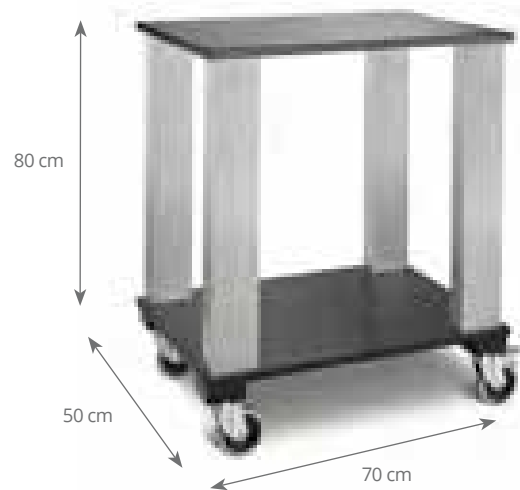

REF	Colour	
P80219	Negro / Black / Noir	1

**P80216** **Oak melamine gueridon trolley**  
*Carro guerdón melamina roble*  
 Chariot guéridon mélamine roure



REF		
P80216		1

**P90813** **Cutlery dispenser trolley**  
*Carro porta-cubiertos*  
 Chariot porte couverts

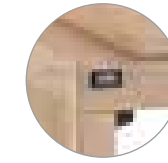

**Trays, dishes, GN containers and cutlery dispenser not included**  
*No incluye porta-cubiertos, cubetas GN, platos ni bandejas*  
 Ramasse-couverts, bacs GN, assiettes, et plateaux pas compris

REF		
P908132		1
P90813		1

**P90814** **Cutlery bin**  
*Porta-cubiertos*  
 Ramasse-couverts

**EXCLUSIVE**

4 x 1/3 GN  
 H max. 6,5 cm



**GN containers not included**  
*No incluye cubetas GN*  
 Bacs GN non inclus

REF	W x D x H mm	
P908142	710 x 335 x 155	1
P90814	710 x 335 x 155	1

BUFFET & ACCESSOIRES  
 BUFFET / ACCESSORIOS  
 BUFFET ET ACCESSOIRES

BUFFET & ACCESSOIRES  
 BUFFET / ACCESSORIOS  
 BUFFET ET ACCESSOIRES

# 14.8 Chafers & dispensers

Chafings y dispensadores  
Chafers et distributeurs



Un elegante y versátil chafar con un diseño de perfil bajo para una mejor presentación.

Modelo con parte superior de vidrio que permite ver la comida sin abrir el chafar - manteniendo la calidad del alimento.

Tapa removible con bisagra de cierre lento. Tres ángulos de apertura, cerrada, 45° ó 90°.

Soporte reforzado con pies antideslizantes que permite una mayor estabilidad.

La tapa y cubeta con sistema anti-goteo mantienen la condensación fuera del alimento.

Se presenta con cubetas de acero inoxidable brillante o de porcelana.

An elegant yet versatile chafar with a low profile design for the best food presentation.

Glass top version allows viewing of food without opening chafar - maintaining food quality.

Removable cover with baffle, "stay put" hinge design holds cover in closed, 45° or 90° position.

Reinforced bracket with rubber table feet for longer life and to keep chafar in place.

Dripless cover and pans keep condensation off of food and tabletop.

Available with mirror-finished stainless steel or porcelain food pans.

Un chafar élégant à la fois polyvalent et discret pour la meilleure présentation des plats.

Le modèle muni d'un couvercle en verre permet de voir le contenu sans ouvrir le chafar - tout en préservant la qualité des aliments.

Couvercle amovible équipé d'un déflecteur et d'une charnière bloquante qui permet de maintenir le couvercle fermé, à 45° ou à 90°.

Support renforcé avec des pieds de table en caoutchouc afin d'offrir une durée de vie plus longue et un meilleur maintien des chafers.

Le couvercle antigouttes et les bacs empêchent la condensation des aliments et de la table.

Disponibles avec bac à aliments en inox ultra-brillant ou en porcelaine.

**4644010** Rectangular chafing dish with crystal lid  
Chafing dish rectangular con tapa de cristal  
Chauffe-plat rectangulaire avec couvercle en verre

SS Stainless steel  
Cr Crystal  
induction

NEW!



REF	W x D x H cm	
4644010	58,4 x 46,5 x 19,8	1

**4644020** Square chafing dish with crystal lid  
Chafing dish cuadrado con tapa de cristal  
Chauffe-plat carré avec couvercle en verre

SS Stainless steel  
Cr Crystal  
induction

NEW!



REF	W x D x H cm	
4644020	46,4 x 46,4 x 17	1

# Chafers & dispensers 14.8

Chafings y dispensadores  
Chafers et distributeurs

**46132** Square chafing dish  
Chafing dish cuadrado  
Chauffe-plat carré

SS Stainless steel  
induction

NEW!



REF	W x D x H cm	
46132	39,2 x 41,3 x 20,3	1

**46134** Glass top S/S chafar with S/S trim  
Chafing dish cuadrado con tapa cristal  
Chafer inox à couvercle en verre

SS Stainless steel  
Cr Crystal  
induction



REF	W x D x H cm	L	
46134	392 x 176 x 412	5,8	1

**46124** Glass top S/S chafar with S/S trim  
Chafing dish redondo con tapa cristal  
Chafer inox à couvercle en verre

SS Stainless steel  
Cr Crystal  
induction

NEW!



Details in Golden colour.  
Detalles en color dorado.  
Détails en couleur dorée.

REF	Ø cm	H cm	L	
46124	39,4	8	5,8	1

**46125** Glass top S/S chafar with S/S trim  
Chafing dish redondo con tapa cristal  
Chafer inox à couvercle en verre

SS Stainless steel  
Cr Crystal  
induction



REF	Ø cm	H cm	L	
46125	39,4	8	5,8	1

**46130** Food pan  
Fuente interior redonda  
Bac à aliments

SS Stainless steel



REF	cm	L	
46131	39,4 x 7	5,6	1
46861	39,4 x 7	3,8	1 NEW

**46136** Food pan  
Fuente interior cuadrada  
Bac à aliments

SS Stainless steel



REF	W x D x H cm	L	
46137	39,2 x 7,1 x 39,2	6,3	1



# 14.8 Chafers & dispensers

Chafings y dispensadores  
Chafers et distributeurs



**P3875** Rectangular chafing dish roll top lid  
Chafing dish rectangular con tapa roll top  
Chafing dish rectangulaire avec couvercle roll top



Stand, water pan, insert, lid and St/Steel handles.  
With 2 burners.

*Soporte, recipiente, cubeta, tapa y asas de chapa en acero inox. Con 2 quemadores.*

Support, récipient, bac, couvercle et poignées en acier inox. Avec 2 brûleurs.

REF	W x D x H cm	L	
P387500	74 x 45 x 41	9,0	1

**P8975** Round chafing dish roll top lid  
Chafing dish redondo tapa roll top  
Chafing dish rond avec couvercle roll top

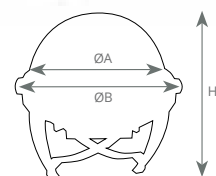

Max. opening: 180°.  
Apertura máxima: 180°.  
Ouverture maximale: 180°.

REF	ØA cm	ØB cm	H cm	
P897500	35	51,5	48,5	1

# Chafers & dispensers 14.8

Chafings y dispensadores  
Chafers et distributeurs



**46080** Oblong roll top chafer  
Chafer apaisado con tapa roll top  
Couvercle roll top rectangulaire chauffe-plat



NEW!

Stand, water pan, insert, lid and St/Steel handles.  
With 2 burners.

*Soporte, recipiente, cubeta, tapa y asas de chapa en acero inox. Con 2 quemadores.*

Support, récipient, bac, couvercle et poignées en acier inox. Avec 2 brûleurs.

REF	W x D x H cm	
46080	65,6 x 44,5 x 46,7	1

**P387** Chafing dish with roll top lid  
Chafing dish con tapa roll top  
Chafing dish avec couvercle "roll top"



Stand, water pan, insert, lid and St/Steel handles.  
With 2 burners.

*Soporte, recipiente, cubeta, tapa y asas de chapa en acero inox. Con 2 quemadores.*

Support, récipient, bac, couvercle et poignées en acier inox. Avec 2 brûleurs.

REF	W x D x H cm	L	
P387065	65 x 38 x 39	9,5	1

**P379** Chafing dish with lid  
Chafing dish con tapa  
Chafing dish avec couvercle



Stand, water pan, insert, lid and St/Steel handles.  
With 2 burners.

*Soporte, recipiente, cubeta, tapa y asas de chapa en acero inox. Con 2 quemadores.*

Support, récipient, bac, couvercle et poignées en acier inox. Avec 2 brûleurs.

REF	W x D x H cm	L	
P379065	65 x 35 x 34	9,5	1

**46095** Gravy/sauce chafer  
Chafer de salsas  
Réchauffeur de sauce



NEW!

REF	W x D x H cm	
46095	31,8 x 29,2 x 37,8	1

**46070** Round roll top chafer  
Chafer redondo con tapa roll top  
Couvercle roll top chauffe-plat



NEW!

REF	W x D x H cm	
46070	49,2 x 48 x 46,5	1

**P3795** Economical chafing dish with lid  
Chafing dish económico con tapa  
Chafing dish économique avec couvercle



Stand, water pan, insert, lid and St/Steel handles.  
With 2 burners.

*Soporte, recipiente, cubeta, tapa y asas de chapa en acero inox. Con 2 quemadores.*

Support, récipient, bac, couvercle et poignées en acier inox. Avec 2 brûleurs.

REF	W x D x H cm	L	
P379500	65 x 35 x 32	9	1

# 14.8 Chafers & dispensers

Chafings y dispensadores  
Chafers et distributeurs

**P950000** Electric heating unit for chafing dish  
Elemento eléctrico para chafing dish  
Corps de chauffe pour chafing dish

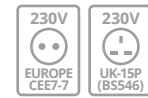

For / Para / Pour:  
P387500, P897500, P387065, P379065, P379500

REF	W	
P950000	240	1

**P962** Hot tray warmer  
Calentador de platos o bandejas  
Réchaud

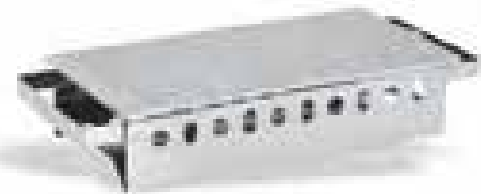

**P3722** Burner holder for chafing dish  
Contenedor para combustible de chafing dish  
Porte-brûleur pour chafing dish



Adaptable. REF:  
P379, P387, P898, P8991

REF		
P372200		24

**P3871** Chafing dish fuel  
**P3872** Fuel para chafing dish  
Fuel pour chafing dish



REF	cm	Lenght / Duración Durée	
P387100	65 x 55	3 h	75
P387200	83 x 60	6 h	60

**46110** Universal electric chafer heater  
Elemento eléctrico universal para chafing dish  
Résistance électrique pour chafers

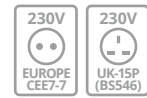

Sized to fit standard fuel opening.  
Dimensiones compatibles con el orificio para combustible estándar.  
Dimensions compatibles avec l'orifice pour combustible standard.

REF	For / Para	V	W	A	Ench. Plug	
46110	EU	230	120/230	1.0	EU	1
46115	UK	230	120/230	1.0	UK	1

REF	Burners / Quemadores Brûleurs	W x D x H cm	
P962002	2	370 x 175 x 70	10
P962003	3	430 x 175 x 70	10

St/Steel with aluminium cover plate.  
Inox con placa base de aluminio.  
Inox avec plaque couvercle en aluminium.

2 or 3 burners.  
2 ó 3 quemadores.  
2 ou 3 brûleurs.

**P685** Chafing dish fuel barrel  
Fuel para chafing dish  
Bidón fuel chafing dish



No soot. No smell  
Sin hollín. Sin olor  
Pas de suie. Inodore

REF	L	KG	
P685004	5	5	3

Thanks to its special formula no storage or transport restriction are involved. Resealable. Non spill - Non drip. Non flammable. Non combustible. Non toxic fuel. Easy open & close. Container does not become hot to touch. Does not evaporate if left uncapped.

Gracias a su fórmula especial no hay ninguna restricción especial por almacenaje o transporte. No gotea ni se derrama. No se evapora si se deja abierto. Puede guardarse si no se consume todo. No inflamable. No tóxico. Fácil de abrir y cerrar. La lata no se calienta. Fácil de encender una vez apagada.

Grâce à sa formule spéciale il n'y pas de restriction pour le stockage et le transport. Hermétique. Non inflammable. Non combustible. Non toxique. Facile à ouvrir et fermer. On peut le garder si on ne le consomme pas tout. Facile à allumer une fois éteint.

# Chafers & dispensers 14.8

Chafings y dispensadores  
Chafers et distributeurs



**P903** Cooling plate  
Placa enfriadora  
Plaque réfrigérante



REF	Type / Tipo	cm	
P903001	1/1	53 x 32,5	4
P903002	1/2	32,5 x 26,5	6

For an easy and hygienic presentation of cold food. Simple place in the freezer. Minimum 4 hour under -4°C. Tolerance under 23°C: 5-6h.

Para una presentación fácil e higiénica de alimentos fríos en los buffets. En el congelador: Mínimo 4h por debajo de los -4 °C. Aguanta 5-6h con temperaturas por debajo de los 23 °C.

Pour une présentation hygienique et facile des aliments froids sur les buffets. Au congélateur. Minimum 4h à des températures inférieures à -4 °C. Résistance à des températures inférieures à 23 °C: 5-6h.

**78710** Bain maries  
Baño maría  
Bain-marie



REF	Ø cm	H cm	L	
78710	10,5	14,5	1,20	6
78720	12,5	17,0	1,90	6
78725	15,5	10,0	1,90	6
78730	15,5	18,5	3,30	6
78740	16,5	19,5	4,00	6
78760	18,5	22,0	5,70	6

# 14.8 Chafers & dispensers

Chafings y dispensadores  
Chafers et distributeurs



**4609** Coffee urn  
Urna de café  
Boîte à café

**NEW!**

SS  
Stainless steel



46093 46094

REF	W x D x H cm	
46093	31,6 x 34,3 x 50,3	1
46094	39,4 x 41,8 x 54,5	1

**46285** Cold beverage server  
Dispensador de bebidas frías  
Distributeur boisson froide

**NEW!**

SS PC  
Stainless steel Polycarbonate



REF	W x D x H cm	
46285	20,3 x 28 x 53,3	1

**4635810** Somerville cold beverage server  
Dispensador de bebidas frías-Somerville  
Distributeur de boisson froide Somerville

**NEW!**

SS PC  
Stainless steel Polycarbonate



REF	W x D x H cm	
4635810	24,6 x 29 x 64	1

**4635110** Somerville milk dispenser  
Dispensador de leche-Somerville  
Distributeur de lait Somerville

**NEW!**

SS  
Stainless steel



REF	W x D x H cm	
4635110	20,3 x 32,7 x 41,4	1

# Chafers & dispensers 14.8

Chafings y dispensadores  
Chafers et distributeurs

**P8992** Juice dispenser St/Steel  
Dispensador de zumos - acero inox  
Distributeur à jus - acier inox

SS PC  
Stainless steel Polycarbonate



REF	L	
P899200	8	1

**P8993** St/Steel milk dispenser  
Dispensador de leche - acero inox  
Distributeur à lait - acier inox

SS  
Stainless steel



REF	L	
P899300	8	1

**4635210** Double Cereal Dispenser  
Dispensador de cereales doble  
Distributeur à céréales double

SS PC  
Stainless steel Polycarbonate



REF	W x D x H cm	L (x2)	
4635210	31 x 22 x 60	3,8	1

**T3660** D-Lux cereal dispenser  
Dispensador de cereales D-Lux  
Distributeur à céréales D-Lux

SS Ac  
Stainless steel Acrylic



REF	W x D x H cm	L	
T3660	25,4 x 35,6 x 68,6	8	1

BUFFET & ACCESSOIRES  
BUFFET & ACCESSOIRES  
BUFFET & ACCESSOIRES

BUFFET & ACCESSOIRES  
BUFFET & ACCESSOIRES  
BUFFET & ACCESSOIRES

# 14.9 Bowls & serving trays

Bols & bandejas de servicio  
Bols & plateaux

18/10  
Stainless steel

**Double wall insulated serving bowls that allows keeping the food temperature, whether cold or hot.**

Construcción aislante de pared doble que permite conservar la temperatura de los alimentos, ya sean fríos o calientes.

Construction d'isolation à double paroi qui permet de maintenir la température de la nourriture, froide ou chaude.



**Will not TRANSPIRE. Requires no preheating or chilling**

No transpiran. No es necesario precalentar o enfriar  
Pas de condensation sur les parois. N'exige aucun préchauffage ou refroidissement

**Insulating walls that keep food at service temperature**

Paredes aislantes que mantienen los alimentos a la temperatura de servicio  
Construction isolant qui garde les aliments à la température de service



**HAND WASHING**  
LAVAR A MANO  
HAND WASHING

**COLD RETENTION: Double wall insulated bowls TEST PROTOCOL, 2004**

RETENCIÓN DEL FRÍO: Bols aislantes de doble pared PROTOCOLO DE PRUEBA, 2004

RÉTENTION DU FROID: Construction d'isolation à double paroi PROTOCOLE D'ESSAI, 2004

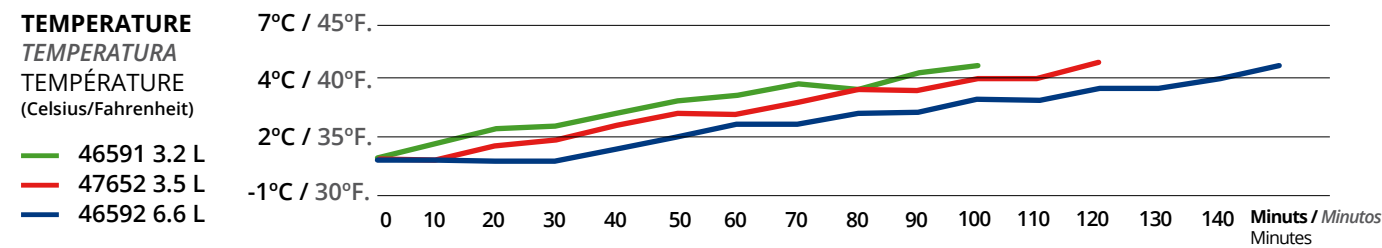

1. Se colocó ensalada de patatas en diversos bols, llenando ¾ de la capacidad del bol.

2. Temperatura inicial de la comida 0,6°C; temperatura ambiente 20,6°C.

3. Cada 10 minutos se registró la temperatura en el centro de la ensalada.

4. La prueba concluyó cuando la comida alcanzó una temperatura de 5°C.

1. Potato salad was placed in different bowls. Filling ¾ of the capacity of the bowl.

2. Initial temperature of the food 0,6°C; ambient temperature 20,6°C.

3. The temperature in the centre of the salad was recorded every 10 minutes.

4. The test concluded when the food reached a temperature of 5°C.

1. La salade de pommes de terre a été placée dans différents bols. Remplissage ¾ de la capacité du bol.

2. La température initiale de l'aliment 0,6°C; température ambiante 20,6°C.

3. La température au centre de la salade a été enregistrée toutes les 10 minutes.

4. Le test s'est terminé lorsque la nourriture a atteint une température de 5°C.

# Bowls & serving trays 14.9

Bols & bandejas de servicio  
Bols & plateaux

18/10  
Stainless steel

**46587 Round colored double wall bowls**  
Bol colores redondo doble pared  
Bols ronds de service à double paroi isothermes en couleurs

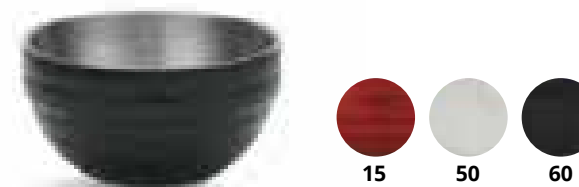

REF	Ø cm	H cm	L	☐
46590 + COLOR	18,4	10,3	1,6	6
46591 + COLOR	24,1	12,9	3,2	6
46592 + COLOR	30,0	16,5	6,6	3

**46584 Angled beehive bowls**  
Bol inclinado doble pared  
Bols nid d'abeilles à paroi inclinée



REF	Ø cm	H cm	L	☐
46584	18,8	13,9	0,95	6
46585	24,0	17,3	1,7	6
46586	30,0	20,9	3,5	2
46582	35,0	23,9	4,7	2

**46587 Beehive style double-wall serving bowls**  
Bol estridado redondo doble pared  
Bol à bande rond double paroi



**Mirror finished**  
Acero inoxidable brillante  
Polissage brillant



REF	Ø cm	H cm	L	☐
46587	14,4	7,6	0,7	6
46590	18,4	10,3	1,6	6
46591	24,1	12,9	3,2	6
46592	30,0	16,5	6,6	3
46569	35,0	17,5	9,6	2

**47619 Square colored double wall bowls**  
Bol colores cuadrado doble pared  
Bols carrés de service à double paroi isothermes en couleurs



REF	cm	H cm	L	☐
47632 + COLOR	18,4 x 18,4	8,7	1,7	12
47634 + COLOR	21,6 x 21,6	10,8	3,0	6
47635 + COLOR	25,8 x 25,8	13,0	4,9	4

**47619 Double-wall square beehive serving bowls**  
Bol estriado cuadrado doble pared  
Bol lis carré double paroi

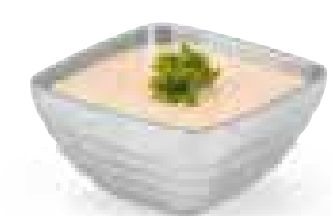

REF	W x D x H cm	L	☐
47619	13,9 x 13,9 x 7	0,7	6
47632	18,5 x 18,5 x 8,9	1,7	12
47634	21,8 x 21,8 x 10,8	3,0	6
47635	24,4 x 24,4 x 13,1	4,9	4
47637	29,9 x 29,9 x 15	7,8	3

**46665 Beehive style double-wall serving bowls**  
Bol redondo doble pared con aro brillante  
Bol bande brillante rond double paroi



**Body mat finished.**  
**Rim mirror finished.**  
Cuerpo pulido satinado.  
Borde superior pulido brillante.  
Finition corps satinée.  
Finition bande brillante.



REF	Ø cm	H cm	L	☐
46665	14,4	7,6	0,7	6
46666	18,4	10,3	1,6	6
46667	24,1	12,9	3,2	6

# 14.9 Bowls & serving trays

Bols & bandejas de servicio  
Bols & plateaux

18/10  
Stainless  
steel

Borde con acabado satinado e interior brillante, creando una elegante contraste visual

Satin-finished rim and mirror-finished interior creates a visual contrast that accentuates the food product

Le rebord satiné et l'intérieur ultra-brillant crée un contraste visuel qui met en valeur les plats

**82093** Rectangular Stainless Steel serving trays  
Bandeja servicio rectangular acero inoxidable  
Plateau service rectangulaire



REF	cm	
82093	30,5 x 22,9	3
82094	45,7 x 25,4	3
82095	53,3 x 30,5	3

**46221** Curved tray  
Bandeja curva  
Plateau incurvé



REF	cm	
46221	19,1 x 19,1	1

NEW!

**P3174** Economical oval serving dish with rolled edge  
Fuente oval borde vuelto económica  
Plat ovale à bords ronds économique

Mirror finished  
Pulido brillante  
Polissage brillant



REF	cm	
P317425	25 x 17,5	60
P317430	30 x 21,0	60
P317435	35 x 24,0	60
P317440	40 x 26,5	40
P317445	45 x 29,5	30
P317450	50 x 34,0	24

**P317** Oval serving dish with rolled edge  
Fuente oval borde vuelto  
Plat ovale à bords ronds

Satin finished  
Pulido satinado  
Polissage satiné



REF	cm	
P317025	25 x 17,2	1
P317030	30 x 20,2	1
P317035	35 x 23,3	1
P317040	40 x 26,7	1
P317045	45 x 29,2	6
P317050	50 x 31,2	1

# Bowls & serving trays 14.9

Bols & bandejas de servicio  
Bols & plateaux

**P907** St/Steel soup tureen with stand  
Sopera inox con base  
Soupière inox avec pied

SS  
Stainless  
steel

Mirror finished  
Pulido brillante  
Polissage brillant



REF	Ø cm	L	
P907024	24	2,50	6
P907026	26	3,50	6

**P927** Acrylic round salad bowl  
Ensaladera acrílica redonda  
Saladier rond acrylique

Ac  
Acrylic



REF	Ø cm	H cm	
P927000	25,8 x 15,8	15,8	6

**P928** Acrylic Squared salad bowl  
Ensaladera acrílica cuadrada  
Saladier carré acrylique

Ac  
Acrylic



P928000



P928001

REF	W x D x H cm	
P928000	28,5 x 28,5 x 12,4	12
P928001	14,7 x 14,7 x 7	48

See products on / Ver productos en / Voir produits en page

P. 388

Bandejas de servicio y buffet  
Bandejas de servicio y buffet  
Plateaux de service et de buffet





SS  
Stainless  
steel

# Serving tools 14.10

Utensilios de servicio  
Ustensiles de service buffet

## CLASSIC LINE



**P361** One piece ladle  
*Cacillo monobloc*  
Louche monobloc



REF	Ø cm	L cm	L	📦
P361000	9	30	0,10	120

**P362** One piece skimmer  
*Espumadera monobloc*  
Écumoire monobloc



REF	Ø cm	L cm	L	📦
P362000	11	33,5	10,40	120

**P363** One piece turner  
*Espátula monobloc*  
Spatule monobloc



REF	L cm	📦
P363000	32	120

**P364** One piece serving spoon  
*Cuchara de servicio monobloc*  
Cuillère de service monobloc



REF	L cm	📦
P364000	31	120

**P365** One piece fork  
*Tenedor monobloc*  
Fourchette monobloc



REF	L cm	📦
P365000	32	120

**P366** One piece sauce ladle  
*Cacillo salsas monobloc*  
Cuillère à sauces monobloc



REF	Ø cm	L cm	L	📦
P366000	7	28	0,10	120

**P367** One piece salad spoon  
*Cuchara ensalada monobloc*  
Cuillère à salade monobloc



REF	L cm	📦
P367000	30	72

**P368** Carving knife  
*Cuchillo cocina*  
Couteau à pâtisserie



REF	L cm	📦
P368000	28,5	240

**P369** Cake server  
*Pala pasteles*  
Pelle à gâteau



REF	L cm	📦
P369000	22	120

# 14.10 Serving tools

Utensilios de servicio  
Ustensiles de service buffet



## ERGO LINE



Mirror polishing.  
Pulido brillante.  
Polissage brillant.

**P3611** One piece ladle  
Cacillo monobloc  
Louche monobloc

REF	Ø cm	L cm	L	
P361100	9,5	32	0,15	48

**P3621** One piece skimmer  
Espumadera monobloc  
Écumoire monobloc

REF	Ø cm	L cm	L	
P362100	11	35	7,15	48

**P3631** One piece turner  
Espátula monobloc  
Spatule monobloc

REF	L cm	
P363100	37	48

**P3641** One piece serving spoon  
Cuchara de servicio monobloc  
Cuillère de service monobloc

REF	L cm	
P364100	34,5	48

**P3651** One piece fork  
Tenedor monobloc  
Fourchette monobloc

REF	L cm	
P365100	37	48

**P3671** Spaghetti server  
Cuchara para spaghetti  
Cuillère à spaghetti

REF	L cm	
P367100	35	48

**P3691** Cake server  
Pala pasteles  
Pelle à gâteau

REF	L cm	
P369100	31	48

# Serving tools 14.10

Utensilios de servicio  
Ustensiles de service buffet



## COMET LINE



Mat satiny finished.  
Pulido satinado mate.  
Poli satiné mat.

**P341** One piece ladle. 18% cr. St/Steel  
Cacillo monobloc. Acero inox 18% cr.  
Louche monobloc. inox 18% cr.

REF	Ø cm	L cm	L	
P341000	8,5	28	0,10	120

**P342** One piece skimmer. 18% cr. St/Steel  
Espumadera monobloc. inox 18% cr.  
Écumoire monobloc. inox 18% cr.

REF	Ø cm	L cm	
P342000	11	33	120

**P343** One piece turner. 18% cr. St/Steel  
Espátula monobloc. inox 18% cr.  
Spatule monobloc. inox 18% cr.

REF	L cm	
P343000	33	120

**P344** One piece fork. 18% cr. St/Steel  
Tenedor monobloc. inox 18% cr.  
Fourchette monobloc. inox 18% cr.

REF	L cm	
P344000	30	120

**P345** One piece spoon. 18% cr. St/Steel  
Cuchara monobloc. inox 18% cr.  
Cuillère monobloc. inox 18% cr.

REF	L cm	
P345000	34	120

**48144** Steak knife black plastic handle  
Cuchillo chuletero, mango plástico negro  
Couteau Steak manche noir plastique

REF	Blade / Hoja / Lame L cm	Total L cm	Pack: 12 u.
48144	12,4	25,1	12

**48148** Steak knife riveted wooden handle  
Cuchillo chuletero, mango plástico madera  
Couteau Steak manche bois plastique

REF	Blade / Hoja / Lame L cm	Total L cm	Pack: 12 u.
48148	12,7	25,1	12

# 14.10 Serving tools

Utensilios de servicio  
Ustensiles de service buffet

SS  
Stainless  
steel

NEW!

**46905** Ladle with one spout  
*Cacillo con un pico lateral*  
Louche avec bec latéral



REF	L cm	
46905	28,71	12

**46907** Ladle with one spout  
*Cacillo con un pico lateral*  
Louche avec bec latéral



REF	L cm	ml	
46907	32	59,15	12

**46909** Ladle  
*Cacillo*  
Louche



REF	L cm	
46909	32	12

**46936** Pastry server  
*Servidor de pasteles*  
Pelle de service



REF	L cm	
46936	28	12

**46952** Serving spoon  
*Cuchara de servicio*  
Cuillère de service



REF	L cm	
46952	29,5	12

**46960** Slotted serving spoon  
*Cuchara perforada para servir*  
Cullière à fente de service



REF	L cm	
46960	30,5	12

**6440** Spoon  
*Cuchara*  
Cullière



64404  
64407

64403  
64406

REF	L cm	
64403	33,60	12
64404	33,60	12
64406	39,37	12
64407	39,37	12

# Serving tools 14.10

Utensilios de servicio  
Ustensiles de service buffet

SS  
Stainless  
steel

Ny  
Nylon



**P33621** Ladle  
*Cacillo*  
Louche

REF	L cm	Lts	
P33621	35	0,08	1

**P33622** Serving spoon  
*Cuchara de servicio*  
Cuillère de service



REF	L cm	
P33622	35	1

**P33623** Slotted spoon  
*Cuchara perforada*  
Cuillère à fente



REF	L cm	
P33623	35	1

**P33624** Turner  
*Espátula*  
Patule



REF	L cm	
P33624	35	1

**P33625** Spaghetti server  
*Cuchara para spaghetti*  
Cuillère à spaghetti



REF	L cm	
P33625	35	1



dishwasher  
-40°C +210°C



# 14.10 Serving tools

Utensilios de servicio  
Ustensiles de service buffet



**P33801** Serving spoon  
Cuchara de servicio  
Cuillère de service



REF	L cm	Icon
P33801	30,5	1

**P33802** Slotted spoon  
Cuchara perforada  
Cuillère à fente



REF	L cm	Icon
P33802	30,5	1

**P33803** Turner  
Espátula  
Spatule



REF	L cm	Icon
P33803	30,5	1

**P33804** Spaghetti server  
Cuchara para spaghetti  
Cuillère à spaghetti



REF	L cm	Icon
P33804	30,5	1

**P33805** One piece fork  
Tenedor de mesa  
Fourchette



REF	L cm	Icon
P33805	30,5	1

**P33806** Serving tong  
Pinza de servicio  
Pince de service

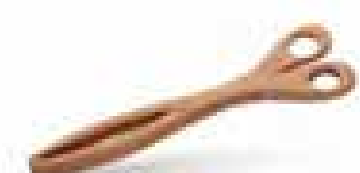

REF	L cm	Icon
P33806	28	1

**P33807** Bread spoon  
Pinza de pan  
Pince à pain



REF	L cm	Icon
P33807	25,5	1

**P33808** Salad hands  
Servidor de ensalada  
Serveur salade



REF	L cm	Icon
P33808	17,5	1

Pack: 2 u.

**P33809** Knife  
Cuchillo  
Couteau



REF	L cm	Icon
P33809	17,5	1

# Serving tools 14.10

Utensilios de servicio  
Ustensiles de service buffet



**P358** Coloured BPA Free utility tong  
Pinza buffet BPA Free color  
Pince buffet SANS BPA en couleurs



REF 358 + L + COLOR



REF	L cm	Clear Transp.	White Blanco Blanc	Red Rojo Rouge	Black Negro Noir	Icon
P358	23	0	1	2	7	1

**46938** Buffet tong  
Pinza buffet  
Pince à buffet



REF	L cm	Icon
46938	30,5	6

**46926** Serving tong  
Pinza servicio  
Pince de service

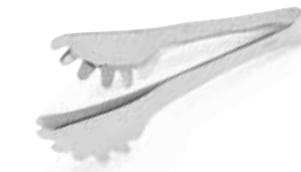

REF	L cm	Icon
46926	21	12



**4698** Spaghetti tong  
Pinza espagueti  
Pince à spaghetti

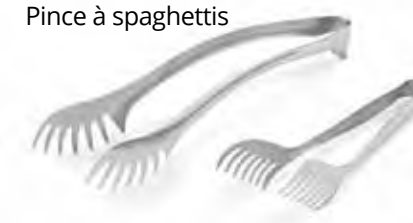

REF	L cm	Icon
46988	23,0	12
46989	29,2	12



# 14.10 Serving tools

Utensilios de servicio  
Ustensiles de service buffet



**P359** Serving tong  
Pinza de servicio  
Pince de service



REF **P359000** L cm 24 1

**P353** Salad tong  
Pinza ensalada  
Pince à salade



REF **P353000** L cm 26,5 120

**46928** Bread tong  
Pinza pan  
Pince à pain



REF **46928** L cm 23,5 12

**P606** Bread tong  
Pinza pan  
Pince à pain



REF **P606000** L cm 25 72

**P605** Pasta tong  
Pinza pasta  
Pince à pâtes



REF **P605000** L cm 24 120

**P351** Spaghetti tong  
Pinza spaghetti  
Pince à spaghetti



REF **P351000** L cm 19 120

**P352** Cake tong  
Pinza repostería  
Pince à gâteau



REF **P352000** L cm 18 120

**P617** Tong with ring  
Pinza anillas  
Tong with ring



REF **P617017** L cm 17 100

# Serving tools 14.10

Utensilios de servicio  
Ustensiles de service buffet



**P618** Burger tong  
Pinza hamburguesa  
Pince à "burger"



REF **P618000** L cm 24 1

**46929** Pastry tong  
Pinza pastelería  
Pince à pâtisserie



REF **46929** L cm 20 24



**P615** Nut cracker  
Cascanueces  
Casse-noix



REF **P615000** L cm 16,5 120

**P902** Butcher's tong  
Pinza charcutería  
Pince à charcuterie



REF **P902000** L cm 10,5 x 5 1

**P389** Aluminium lobster cracker  
Pinza para mariscos en aluminio  
Casse-pattes en aluminium



REF **P389000** L cm 14 144

# 14.11 Signs

Señalización  
Signalization

## P19117 Barrier with retractable belt

Poste con cinta retráctil  
Poteau dérouleur à sangle

SS  
Stainless steel  
Pintado negro  
Black-painted  
Peint noir



REF	H cm	Kg	
P19117	90	7	2

## P19114 Barrier with retractable belt

Poste con cinta retráctil  
Poteau dérouleur à sangle

SS  
Stainless steel

Mirror Polished.  
Pulido brillante.  
Polissage brillant.

Detachable head.  
Cabezal removible.  
Tête amovible.

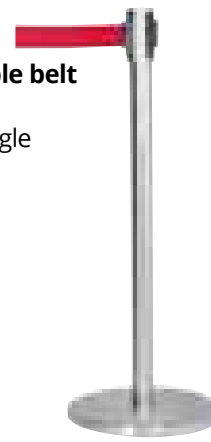

REF	Colour / Color / Couleur	H cm	L cm	Kg	
P19114N	●	94	200	9	1
P19114A	●	94	200	9	1
P19114R	●	94	200	9	1

## P19118 Information sign

Panel información  
Panneau information

SS  
Stainless steel

For barrier  
Para poste  
Pour poteau  
P19.117



REF	cm	
P19118	22 x 46	10

## P19115 Spare head

Recambio cabezal  
Rechange de sangle

SS  
Stainless steel

For barrier  
Para poste  
Pour poteau  
P19.114



REF	Colour / Color / Couleur	L cm	
P19115N	●	200	12
P19115A	●	200	12
P19115R	●	200	12

## P19116 Information sign

Panel información  
Panneau information

SS  
Stainless steel

For barrier  
Para poste  
Pour poteau  
P19.114



REF	cm	
P19116	21,8 x 32	10

## P19100 St/Steel barrier

Poste separación acero inoxidable  
Poteau acier inoxydable

SS  
Stainless steel

P19100  
Mirror Polished.  
Pulido brillante.  
Polissage brillant.

P19101  
Golden coated.  
Baño dorado.  
Doré.

Belt not included  
Cordón no incluido  
Cordon non inclus

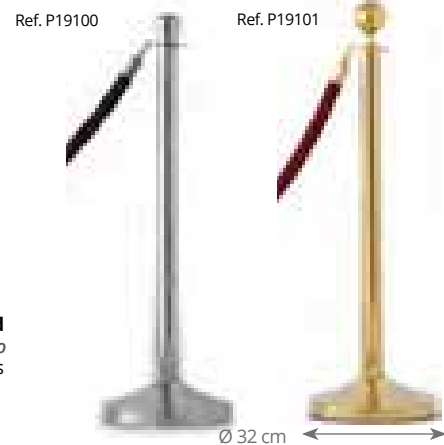

REF	H cm	Kg	
P19100	95	10,5	2
P19101	100	10,5	2

## P19105 Belt with chromium-plated ends

Cordón con ganchos cromados  
Cordon à crochets chromés

Te  
Textile



REF	Colour / Color / Couleur	L cm	
P19105	●	150	18
P19107	●	150	18
P19103	●	150	18

## P19106 Belt with golden ends

Cordón con ganchos dorados  
Cordon à crochets dorés

Te  
Textile



REF	Colour / Color / Couleur	L cm	
P19106	●	150	18
P19104	●	150	18

# Signs 14.11

Señalización  
Signalization

Produced from special plastic completely anti-scratch material. Solid wood frame double-lacquered. Rain and sunproof. Writing-surfaces specially designed for using water based chalkmarkers.

Fabricadas con un material plástico especial que no se raya. Marcos de madera resistentes al agua y al sol. Pizarras especialmente diseñadas para el uso de tizas o rotuladores con base de agua.

Fabriqués avec un matériel plastique spécial anti-rayures. Cadres en bois massif. Résistants à la pluie et au soleil. Tableaux spécialement conçus pour l'utilisation des craies ou marqueurs avec base à eau.

## P21000 / P21001 Caballete - Duo

Wo  
Wood

PI  
Plastic



REF	W cm	H cm	
P21000	75	135	1
P21001	55	85	1

## P21003 Caballete - Uno

Wo  
Wood

PI  
Plastic



REF	W cm	H cm	
P21003	55	85	1

## P2100 Universal

Wo  
Wood

PI  
Plastic

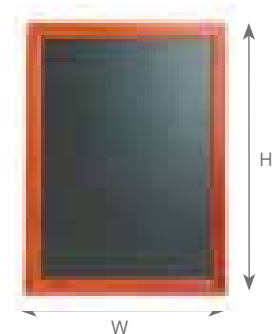

REF	W cm	H cm	
P21005	50	60	5

## P2101 Lucky

Wo  
Wood

PI  
Plastic

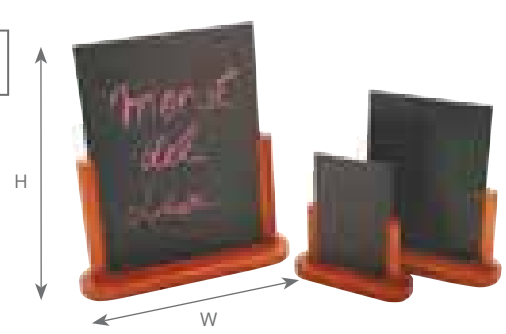

REF	W cm	H cm	
P21015	10	15	36
P21016	15	21	24
P21017	21	30	10

## P2102 Basic

PI  
Plastic



REF	W cm	H cm	
P21027	10	15	200
P21028	15	23	100

## P21020-26 Chalkmarker

Marcador tiza  
Marqueur

PI  
Plastic

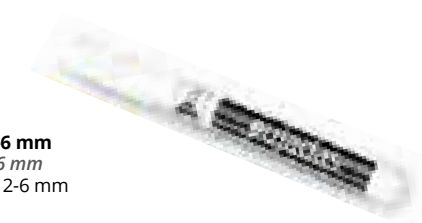

Widths 2-6 mm  
Grueso 2-6 mm  
Épaisseur 2-6 mm

REF	Colour / Color / Couleur	
P21020	White / Blanco / Blanc	500

# 15 Table service

Servicio de mesa  
Arts de table

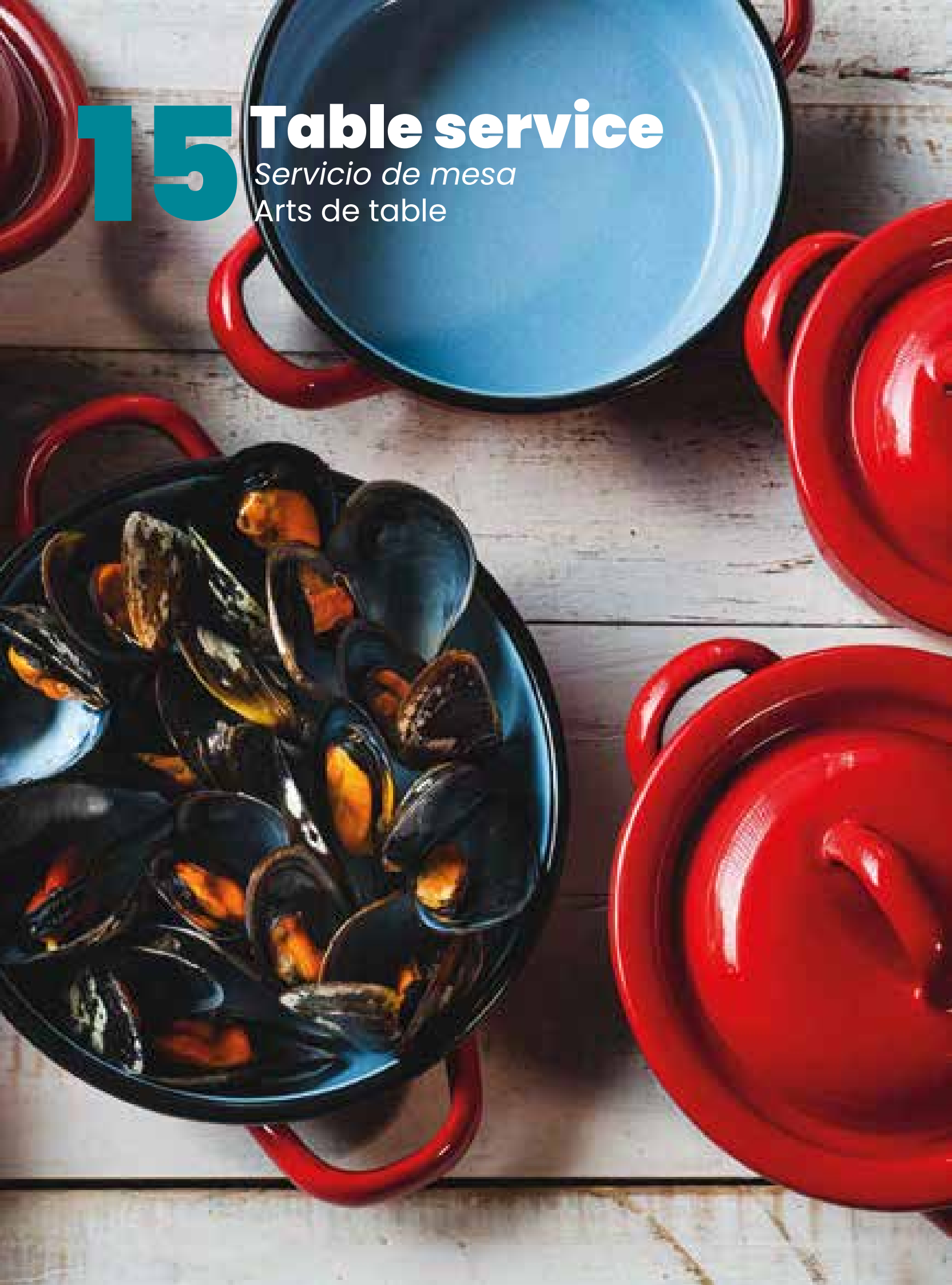

## 15.1 MINIATURES 454

MINIATURAS / MINIATURES

<b>Stainless steel</b> / Acero inoxidable / Acier inoxidable	454
<b>Enamelled steel</b> / Acero esmaltado / Acier émaillé	458
<b>Cast aluminium</b> / Aluminio de fundición / Fonte d'aluminium	459
<b>Cast iron</b> / Hierro fundido / Fonte émaillée	460

## 15.2 TABLE PRESENTATION 462

PRESENTACIÓN DE MESA / PRÉSENTATION TABLE

<b>Wood</b> / Madera / Bois	462
<b>Taco and sandwich tray</b> / Tacos y bocadillos presentación Présentation de Tacos et sandwichs	463
<b>Tin plates display</b> / Llaunas presentación / Plateaux inox présentation	464
<b>Slates</b> / Pizarras / Ardoises	466
<b>Natural bamboo</b> / Bambú natural / Bambou naturel	468
<b>Baskets and breadbaskets</b> / Paneras y cestas / Paniers et corbeilles	470
<b>Place mats</b> / Manteles individuales / Sets de table	478

## 15.3 TABLE SERVICE 479

SERVICIO DE MESA / SERVICE DE TABLE

<b>Flared sauce cups</b> / Salseras / Saucières	479
<b>Table accessories</b> / Complementos de mesa / Accessoires de table	480
<b>Menu holders</b> / Portamenús / Porte-menus	484
<b>Food &amp; table service</b> / Servicio de mesa / Arts de table	485

# 15.1 Stainless steel miniatures

Miniaturas acero inoxidable  
Miniatures acier inoxydable

SS  
Stainless  
steel



## P24714 Mini round frying pan

Mini sartén redonda  
Mini poêle ronde

NEW!



REF	Ø cm	H cm	📦
P24714	12,0	3,5	6
P24715	15,5	4,5	6

## P24716 Mini round saucepan

Mini cazo redondo  
Mini casserole ronde

NEW!



REF	Ø cm	H cm	📦
P24716	10,5	5	6
P24717	12,0	6	6

## P24718 Mini square frying pan

Mini sartén cuadrada  
Mini poêle carrée

NEW!



REF	W x D x H cm	📦
P24718	12 x 12 x 3,5	6
P24719	14 x 14 x 3,5	6

# Stainless steel miniatures 15.1

Miniaturas acero inoxidable  
Miniatures acier inoxydable

SS  
Stainless  
steel

## P24706 Mini saucepan

Mini cazo  
Mini casserole

NEW!



REF	Ø cm	H cm	📦
P24706	7	4,5	12
P24707	9	5,0	6

## P24711 Mini saucepan. Copper color

Mini cazo. Color cobre  
Mini casserole. Couleur cuivre

NEW!



REF	Ø cm	H cm	📦
P24711	7	4,5	12
P24712	9	5,0	6

## P24708 Mini wok

Mini wok  
Mini wok

NEW!



REF	Ø cm	H cm	📦
P24708	10	3	6

## P24713 Mini wok. Copper color

Mini wok. Color cobre  
Mini wok. Couleur cuivre

NEW!



REF	Ø cm	H cm	📦
P24713	10	3	6

## P24704 Mini frying pan

Mini sartén  
Mini poêle

NEW!



REF	Ø cm	H cm	📦
P24704	11	3,0	6
P24705	12	3,5	6

## P24709 Mini frying pan. Copper color

Mini sartén. Color cobre  
Mini poêle. Couleur cuivre

NEW!



REF	Ø cm	H cm	📦
P24709	11	3,0	6
P24710	12	3,5	6

## 15.1 Stainless steel miniatures

Miniaturas acero inoxidable  
Miniatures acier inoxydable



**P24410** Mini rectangular roasting pan  
Mini rustidera rectangular  
Mini rôtissoire rectangulaire

NEW!



REF	W x D x H cm	
P24410	14,5 x 9,5 x 7,5	12

**P24411** Mini square roasting pan  
Mini rustidera cuadrada  
Mini rôtissoire carrée

NEW!



REF	W x D x H cm	
P24411	11,5 x 11,5 x 7,5	12

**P2440** Mini bucket  
Mini cubo  
Mini seau



REF	Ø cm	H cm	L	
P24407	7,5	6,5	0,15	72
P24409	9,0	8,5	0,32	72

## Stainless steel miniatures 15.1

Miniaturas acero inoxidable  
Miniatures acier inoxydable



**P24415** Serving cup  
Vaso para servir  
Tasse de service



NEW!



REF	Ø cm	H cm	
P24415	8,5	8,5	12

**P24412** Hammered serving cup  
Vaso para servir hammered  
Tasse de service martelée



NEW!



REF	Ø cm	H cm	
P24412	8,5	8,5	12

**P24413** Hammered serving cup. Copper color  
Vaso para servir hammered. Color cobre  
Tasse de service martelée Couleur cuivre



dishwasher

NEW!



REF	Ø cm	H cm	
P24413	8,5	8,5	12

**P24414** Hammered serving cup. Black color  
Vaso para servir hammered. Color negro  
Tasse de service martelée Couleur noire



dishwasher

NEW!



REF	Ø cm	H cm	
P24414	8,5	8,5	12

## 15.1 Enamelled steel miniatures

Miniaturas acero esmaltado  
Miniatures acier émaillé

ES  
Enamelled  
steel

### P99801 Casserole with lid Cazuela con tapa Cocotte avec couvercle



NEW!



REF	Ø cm	H cm	
P998010	10	6,0	1
P998012	12	6,5	1
P998014	14	7,0	1

### P99901 Shallow casserole without lid Cazuela baja sin tapa Cocotte sans couvercle



NEW!



REF	Ø cm	H cm	
P999012	12	6,5	1
P999014	14	7,0	1

### P995 Enamelled steel paella pan Paellera acero esmaltado Plat à paella acier émaillé



REF	Ø cm	Portions / Raciones	
P995010	10	-	1
P995016	15	-	1

### P997 Deep enamelled fry pan with handles Sartén honda esmaltada con asas Poêle haute avec anses



REF	Ø cm	Lts	
P997014	14	0,4	1
P997016	16	0,5	1

## Cast aluminium miniatures 15.1

Miniaturas aluminio de fundición  
Miniatures fonte d'aluminium

CA  
Cast  
Aluminium

Made of cast aluminium with high resistance to deformation and excellent thermal performance.

Non-stick interior coating.

Fabricada en aluminio de fundición de gran resistencia a la deformación y con excelentes prestaciones térmicas.

Revestimiento interior antiadherente.

Fabriqué en fonte d'aluminium très résistante à la déformation et doté d'excellentes performances techniques.

Revêtement intérieur antiadhésif.

### P151100 Mini black casserole with lid Mini cazuela negra con tapa Mini cocotte noire avec couvercle



NEW!

Wooden base included  
Base de madera incluida.  
Base en bois incluse



REF	Ø cm	H cm	
P151100	10	5	1

### P151200 Mini black oval casserole with lid Mini cazuela oval negra con tapa Mini cocotte ovale noire avec couvercle



NEW!

Wooden base included  
Base de madera incluida.  
Base en bois incluse



REF	W x D x H cm	
P151200	13 x 10,5 x 5	1

### P151300 Mini white casserole with lid Mini cazuela blanca con tapa Mini cocotte blanche avec couvercle



NEW!

Wooden base included  
Base de madera incluida.  
Base en bois incluse



REF	Ø cm	H cm	
P151300	10	5	1

### P151400 Mini white oval casserole with lid Mini cazuela oval blanca con tapa Mini cocotte ovale blanche avec couvercle



NEW!

Wooden base included  
Base de madera incluida.  
Base en bois incluse



REF	W x D x H cm	
P151400	13 x 10,5 x 5	1

### P141 Shallow casserole without lid Cazuela baja sin tapa Cocotte sans couvercle



REF	Ø cm	H cm	
P141014	14	4,0	1
P141016	16	5,0	1
P141020	20	5,5	20

### P151 Deep casserole without lid Cazuela alta sin tapa Braiseuse sans couvercle

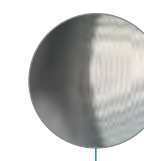

Ground base  
Fondo torneado  
Fond dressé



REF	Ø cm	H cm	
P151012	12	8,5	12
P151014	14	8,5	1
P151016	16	8,0	12

# 15.1 Cast iron miniatures

Miniaturas hierro fundido  
Miniatures fonte émaillée



Enamelled cast iron miniatures perfect for individual service and presentations.

Miniaturas en hierro fundido y esmaltado interior, perfectas para servicio individual y presentación.

Miniatures en fonte émaillée (à l'intérieur) idéales pour le service individuel et la présentation.



**P23500** Mini fry pan  
Mini sartén  
Mini poêle ronde



REF	Ø cm	L cm	H cm	
P23500	10,5	16	2,6	12

**P23501** Mini fry pan  
Mini sartén  
Mini poêle ronde



REF	Ø cm	L cm	H cm	
P23501	13,5	21	2,5	12

**P23502** Mini deep fry pan  
Mini sartén alta  
Mini poêle ronde haute



REF	Ø cm	L cm	H cm	
P23502	14	23,5	3,8	12

**P23503** Mini squared fry pan  
Mini sartén cuadrada  
Mini poêle carrée



REF	W x D x H cm	L cm	
P23503	13,6 x 13,6 x 3,6	23,3	12

# Cast iron miniatures 15.1

Miniaturas hierro fundido  
Miniatures fonte émaillée



**P23504** Mini oblong fry pan  
Mini sartén rectangular  
Mini poêle rectangulaire



REF	W x D x H cm	L cm	
P23504	12,7 x 10,5 x 2,5	18	12

**P23508** Oval casserole  
Cacerola oval  
Mini casserole ovale



REF	W x D x H cm	Lts	
P23508	21,5 x 15,5 x 6,5	0,60	8

**P23505** Mini round casserole with lid  
Mini cacerola con tapa  
Mini cocotte avec couvercle



REF	Ø cm	L cm	H cm	Lts	
P23505	10	13	7,5	0,20	12

**P23507** High round casserole with lid  
Cacerola alta con tapa  
Cocotte haute avec couvercle



REF	Ø cm	H cm	Lts	
P23507	14	9,5	0,70	8

**P23506** Mini oval pan with lid  
Mini fuente oval con tapa  
Mini plateau ovale avec couvercle



REF	W x D x H cm	L cm	
P23506	12 x 8 x 5	15,5	12

**P23509** High mini oval pan with lid  
Mini fuente oval alta con tapa  
Mini plateau ovale haut avec couvercle



REF	W x D x H cm	Lts	
P23509	12,5 x 9,3 x 7,5	0,25	12



## 15.2 Wood serving boards

Tablas de madera  
Planches en bois

Wo  
Wood



**P41008** Wood serving boards  
Tablas de madera  
Planches en bois

NEW!

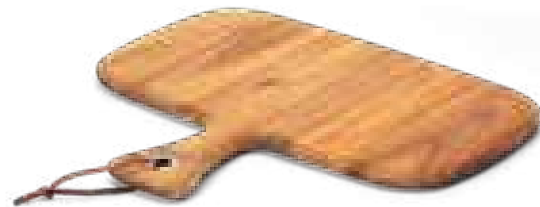

REF	cm	
P41008	28 x 30,5	1

**P41009** Wood serving boards  
Tablas de madera  
Planches en bois

NEW!

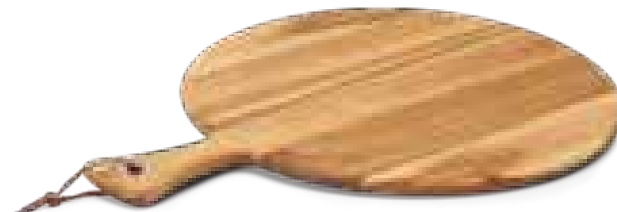

REF	cm	
P41009	40,5 x 30,5	1

**P41010** Wood serving boards  
Tablas de madera  
Planches en bois

NEW!



REF	cm	
P41010	51,8 x 20,3	1

VOLLRATH

**P41011** Wood serving boards  
Tablas de madera  
Planches en bois

NEW!



REF	cm	
P41011	36 x 17,5	1

462

pujadas

## Taco and sandwich tray 15.2

Tacos y bocadillos presentación  
Présentation de Tacos et sandwiches



**P41001** Taco tray. 2-3 compartments  
Soporte tacos. 2-3 compartimentos  
Plateau à Tacos 2-3 compartiments

SS  
Stainless  
steel



REF	W x D x H cm	
P41001	21 x 10,2 x 5	1

VOLLRATH

**P41002** Taco tray. 4-5 compartments  
Soporte tacos. 4-5 compartimentos  
Plateau à Tacos 4-5 compartiments

SS  
Stainless  
steel



REF	W x D x H cm	
P41002	36 x 10,2 x 5	1

463

pujadas

**P41004** Taco tray with wooden base  
Soporte tacos con base de madera  
Plateau à tacos avec base en bois

SS  
Stainless  
steel

Wo  
Wood

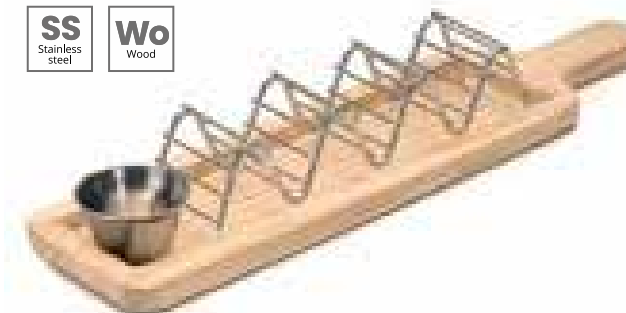

REF	W x D x H cm	
P41004	44 x 10,8 x 6,5	1

**P. 479**

Ramekin / Sauce container  
Recipiente para salsas  
Récipient pour sauces



**P41003** Sandwich tray. 7 compartments  
Soporte bocadillos. 7 compartimentos  
Plateau à sandwiches. 7 compartiments

SS  
Stainless  
steel

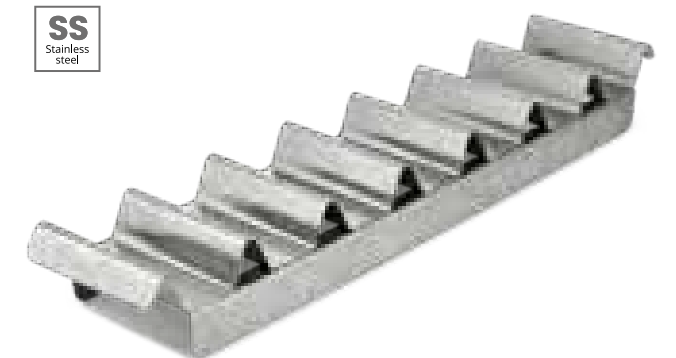

REF	W x D x H cm	
P41003	44 x 10,8 x 6,5	1

TABLE SERVICE  
SERVICIO DE MESA  
ARTS DE TABLE

# 15.2 Tin plates display

Llaunas presentación  
Plateaux inox présentation



## P296415 Stainless steel tray with handles

Llauna inox con asas  
Plaque inox avec anses



REF	Base cm	Total W x D x H cm	
P296415	22 x 14	25,5 x 14 x 1,5	1
P296430	22 x 14	25,5 x 14 x 3	1
P296515	26,5 x 23	30 x 23 x 1,5	1
P296530	26,5 x 23	30 x 23 x 3	1
P296615	32 x 24	35,5 x 24 x 1,5	1
P296630	32 x 24	35,5 x 24 x 3	1
P296715	32 x 18	35,5 x 18 x 1,5	1
P296730	32 x 18	35,5 x 18 x 3	1

## P296300 Cork base

Base de corcho  
Base en liège



dishwasher

REF	W x D x H cm	Suitable for Compatible con Adaptable pour	
P296300	30 x 19 x 3	P296415 - P296430	16
P296400	34,5 x 28 x 3	P296515 - P296530	8
P296500	40 x 29 x 3	P296615 - P296630	8
P296600	40 x 23 x 3	P296715 - P296730	10

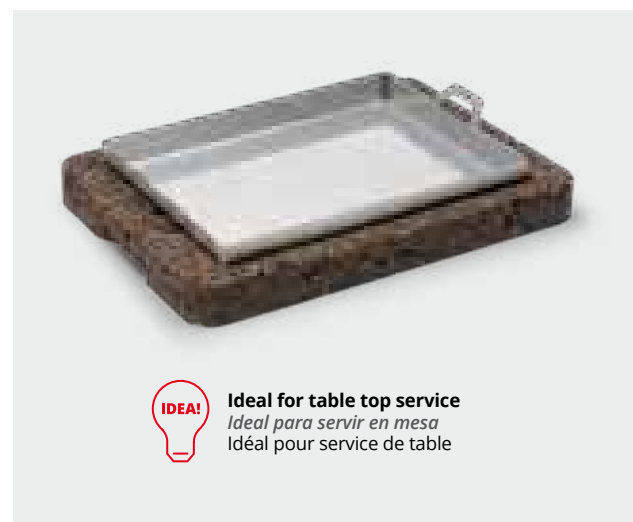

**IDEA!** Ideal for table top service  
Ideal para servir en mesa  
Idéal pour service de table

# Tin plates display 15.2

Llaunas presentación  
Plateaux inox présentation

## P29680 Stainless steel presentation spatula

Pala presentación en inox  
Pelle de présentation en inox



REF	Base cm	Total W x D x H cm	
P29680	23 x 16	38,6 x 16 x 11,5	1

## P2965001 Triangular tray

Llauna triangular  
Plaque triangulaire



REF	W x D x H cm	
P2965001	29 x 29 x 1,5	1

## P29610 Sheet pan with wooden tray with handle

Llauna bandeja presentación rectangular con mango  
Plateau de présentation avec manche



REF	Llauna W x D x H cm	Total W x D x H cm	
P29610	22 x 14 x 2	34 x 18 x 3	6

## P29600 Sheet pan with wooden tray

Llauna bandeja presentación rectangular  
Plateau de présentation



REF	Llauna W x D x H cm	Total W x D x H cm	
P29600	29,5 x 19,5 x 2	33 x 23 x 3	6

## P1950 1/1 GN sheet pan

Llauna bandeja gastronorm 1/1 presentación  
Plateau GN 1/1 de présentation



GN 1/1



REF	Llauna W x D x H cm	Total L cm	
P195000	48 x 32 x 2	52,5	6

## P296 Round sheet pan with wooden tray

Llauna bandeja presentación redonda  
Plateau rond de présentation

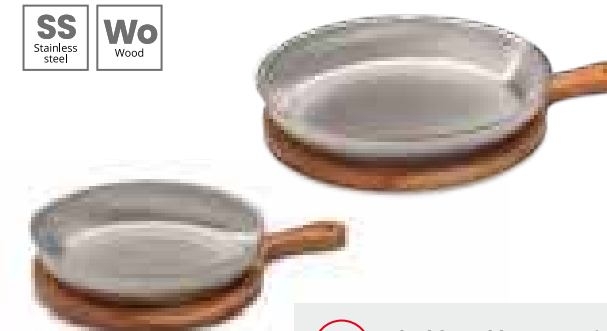

**IDEA!** Ideal for table top service  
Ideal para servir en mesa  
Idéal pour service de table

REF	Llauna Ø cm	Llauna H cm	Total L cm	Total H cm	
P29620	20	4,5	31	5,5	6
P29630	26	4,5	37	5,5	6

## 15.2 Slates

Pizarras  
Ardoises



SI  
Slate

Wo  
Wood

Natural, elegant and exclusive presentation of cold or hot plates.

Presentación natural, elegante y exclusiva de platos fríos o calientes.

Présentation naturelle, élégante et exclusive de plats froids ou chauds.

### P28600 Slate and acacia board

Tabla pizarra y acacia  
Plateau ardoise et bois



REF	W x D x H cm	
P28600	33 x 23 x 1,5	1

### P28610 Slate and acacia board

Tabla pizarra y acacia  
Plateau ardoise et bois



REF	W x D x H cm	L cm	
P28610	26 x 18 x 1,5	34	1

### P28620 Slate and acacia board

Tabla pizarra y acacia  
Plateau ardoise et bois



REF	Ø cm	L cm	H cm	
P28620	21,0	31	1,5	12
P28621	26,5	37	1,5	1

See products on

Ver productos en / Voir produits en page

P. 92

### Display tray

Bandeja presentación  
Plateau présentation



## Slates 15.2

Pizarras  
Ardoises

SI  
Slate

### P28202 Slate serving tray

Pizarra presentación  
Ardoise presentation

BEST  
SELLER



REF	cm	
P28202	20 x 20	24
P28252	25 x 25	16
P28303	30 x 30	1
P28302	30 x 20	16
P28403	40 x 30	10

Polished edges  
Cantos pulidos  
Coins biseautés

Rubber feet  
Pies espumados  
Pieds mousse

4-5 mm  
Thickness  
Espesor  
Epaisseur



### P28501 Slate serving tray

Pizarra presentación  
Ardoise presentation



REF	cm	
P28501	25 x 25	1
P28502	30 x 30	1
P28503	30 x 20	1
P28504	40 x 30	1

### P28505 Slate serving tray

Pizarra presentación  
Ardoise presentation



REF	Ø cm	
P28505	20	1
P28506	30	1

Natural edges  
Cantos naturales  
Coins naturels

5-6 mm  
Thickness  
Espesor  
Epaisseur

Rubber feet  
Pies espumados  
Pieds mousse

Rough surface  
Superficie rústica  
Surface rustique

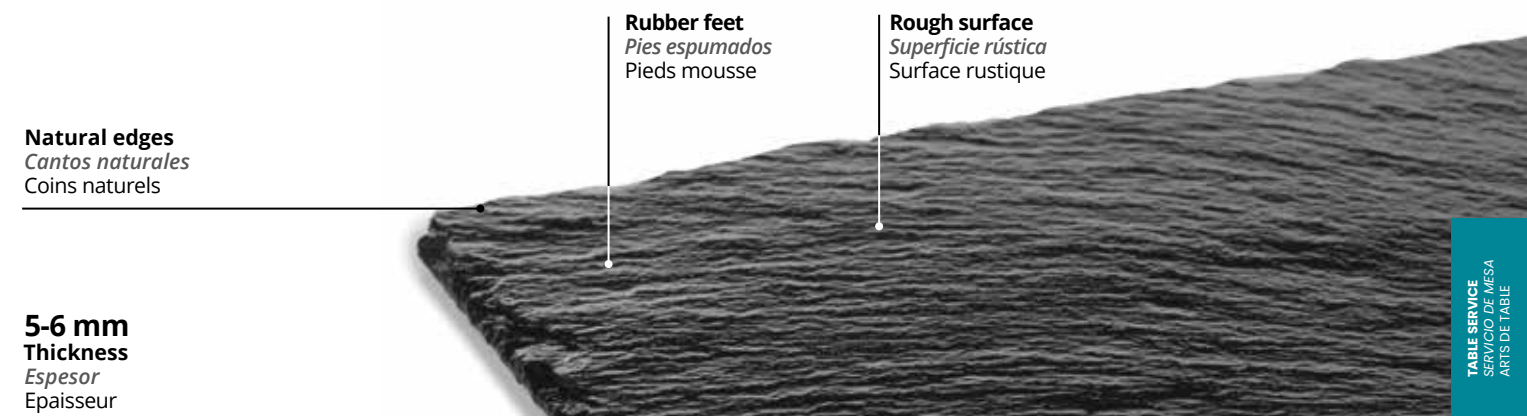

## 15.2 Natural bamboo

Bambú natural  
Bambou naturel



### NATURAL FIBERS

Natural bamboo presentation range for the most demanding hotels and restaurants.

Gama presentación bambú natural para los más exigentes.

Gamme de présentation bambou naturel plus exigeants.



#### P10051 Bamboo sushi board

Tabla bambú presentación sushi  
Planche bamboú présentation sushi



REF	W x D x H cm	📦
P100511	24 x 15 x 3	24
P100512	27 x 18 x 3	24

#### P10052 Curved bamboo sushi board

Tabla curvada bambú sushi  
Planche incurvée bambou présentation sushi



REF	W x D x H cm	📦
P100520	21 x 12 x 2,5	36
P100521	24 x 15 x 3	24
P100522	27 x 18 x 3	24

#### P10060 Sushi boat presentation

Barco presentación sushi  
Bateau présentation sushi



REF	W x D x H cm	📦
P100600	50 x 20 x 31	6
P100601	70 x 25,5 x 45	8

## Natural bamboo 15.2

Bambú natural  
Bambou naturel



#### P10054 Round bamboo steamer

Vaporeira bambú redonda  
Cuit vapeur bambou rond



REF	Ø cm	H cm	📦
P100540	10	4,0	50
P100541	13	5,0	224
P100542	15	5,0	144
P100543	21	5,0	72
P100544	27	5,5	44

#### P10055 Round steamer lid

Tapa vaporeira redonda  
Couvercle cuit vapeur rond



REF	Ø cm	H cm	📦
P100550	10	3,0	500
P100551	13	3,5	272
P100552	15	3,5	204
P100553	21	4,0	102
P100554	27	4,0	60

#### P10053 Sushi rectangular tray

Bandeja rectangular presentación sushi  
Plateau rectangulaire présentation sushi



REF	W x D x H cm	📦
P100530	33 x 22,5 x 8	6
P100531	42 x 32 x 8,5	6

#### P10057 Bamboo tong

Pinza bambú  
Pince bambou



REF	L cm	📦
P100570	20,0	780
P100571	25,5	504
P100572	30,0	444

## 15.2 Baskets and breadbaskets

Paneras y cestas  
Paniers et corbeilles



Mt  
Metal

**P876001** Metal cone basket  
Cesta cono metal  
Panier métal cône

Mt  
Metal

**NEW!**



REF	cm	H cm	
P876001	13 x 13	18	1

**P876002** Metal cone basket 1 ramekin  
Cesta cono metal 1 ramekin  
Panier métal cône 1 ramequin

Mt  
Metal

**NEW!**

Ramekin not included  
Ramekin no incluido  
Ramequin non inclus

Ramekin compatible  
Compatible con ramekin  
Compatible ramequin  
P41007, P41013, P41014,  
P41016, P41017, P41019 y  
P41020



REF	cm	H cm	
P876002	19 x 13	18	1

**P876003** Metal cone basket 2 ramekins  
Cesta cono metal 2 ramekines  
Panier métal cône 2 ramequins

Mt  
Metal

**NEW!**

Ramekin not included  
Ramekin no incluido  
Ramequin non inclus

Ramekin compatible  
Compatible con ramekin  
Compatible ramequin  
P41007, P41013, P41014,  
P41016, P41017, P41019 y  
P41020

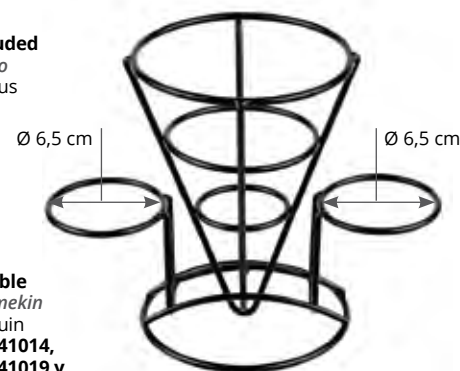

REF	cm	H cm	
P876003	25 x 13	18	1

See products on  
Ver productos en / Voir produits en page

P. 479

Ramekins  
Ramekins  
Ramequins



## Baskets and breadbaskets 15.2

Paneras y cestas  
Paniers et corbeilles

Mt  
Metal

**P591001** Round metal basket  
Cesta metal redonda  
Panier métal rond

Mt  
Metal

**NEW!**

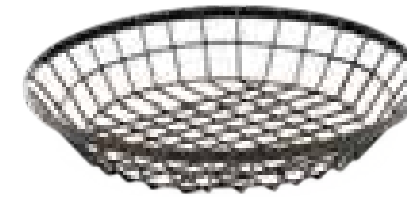

REF	Ø cm	H cm	
P591001	26,5	5	1

**P591002** Oval metal basket  
Cesta metal ovalada  
Panier métal ovale

Mt  
Metal

**NEW!**



REF	W x D x H cm	
P591002	22,5 x 15 x 4,5	1

**P591003** Rectangular metal basket  
Cesta metal rectangular  
Panier métal rectangulaire

Mt  
Metal

**NEW!**



REF	W x D x H cm	
P591003	23 x 10 x 4,5	1

**P591004** Rectangular metal basket  
Cesta metal rectangular  
Panier métal rectangulaire

Mt  
Metal

**NEW!**



REF	W x D x H cm	
P591004	23 x 17,5 x 4,5	1

**P591005** Round metal basket  
Cesta metal redonda  
Panier métal rond

Mt  
Metal

**NEW!**



REF	Ø cm	H cm	
P591005	20,5	13	1

## Baskets and breadbaskets 15.2

Paneras y cestas  
Paniers et corbeilles



**P100816** Brown bread basket  
*Cesta pan marrón*  
Corbeille à pain marron

**Washable**  
*Se puede lavar*  
Peuvent se laver



P100807

REF	W x D x H cm	
P100816	13,0 x 13,0 x 15	1
P100807	17,5 x 17,5 x 15	12
P100836	26,5 x 26,5 x 12	1

**P100808** Grey bread basket  
*Cesta pan gris*  
Corbeille à pain gris

**Washable**  
*Se puede lavar*  
Peuvent se laver



P100808



P100838

REF	W x D x H cm	
P100808	13,0 x 13,0 x 15	1
P100827	17,5 x 17,5 x 15	12
P100838	26,5 x 26,5 x 12	1

**P100817** Black bread basket  
*Cesta pan negra*  
Corbeille à pain noir

**Washable**  
*Se puede lavar*  
Peuvent se laver



P100826

REF	W x D x H cm	
P100817	13,0 x 13,0 x 15	1
P100826	17,5 x 17,5 x 15	1
P100837	26,5 x 26,5 x 12	1



## 15.2 Baskets and breadbaskets

Paneras y cestas  
Paniers et corbeilles

PP  
Polypropylene

**P10074** Bread basket  
*Cesta pan*  
Corbeille à pain



P100740

REF	W x D x H cm	
P100740	29 x 29 x 47,5	12

**P10074** Bread basket  
*Cesta pan*  
Corbeille à pain



P100741

P100742

REF	W x D x H cm	
P100741	36 x 30 x 21 / 39	6
P100742	Ø 29 x 21 / 39	6

**P10074** Bread basket  
*Cesta pan*  
Corbeille à pain



P100780

REF	Ø cm	H cm	
P100780	35	35	12

**P10075** Slated bread basket  
*Cesta redonda inclinada*  
Corbeille ronde inclinée



REF	Ø cm	H cm	
P100754	36	10 / 20	6
P100755	40	13 / 23	6

**P10076** Slated rectangular basket  
*Cesta rectangular inclinada*  
Corbeille rectangulaire inclinée



REF	W x D x H cm	
P100760	40 x 28 x 6 / 10	12
P100761	58 x 38 x 8 / 12	6

**P10077** Two compartment rectangular basket  
*Cesta rectangular dos compartimentos*  
Corbeille rectangulaire deux compartiments



REF	W x D x H cm	
P100770	49 x 31 x 10 / 14,3	6

## Baskets and breadbaskets 15.2

Paneras y cestas  
Paniers et corbeilles

PP  
Polypropylene

**P10079** Round basket  
*Cesta redonda*  
Corbeille ronde



REF	Ø cm	H cm	
P100792	24	5,5	60

**P10080** Round basket  
*Cesta redonda*  
Corbeille ronde



P100804

P100803

P100805

REF	Ø cm	H cm	
P100803	18	6,0	48
P100804	23	6,0	48
P100805	25	6,0	48

**P10081** Round basket  
*Cesta redonda*  
Corbeille ronde

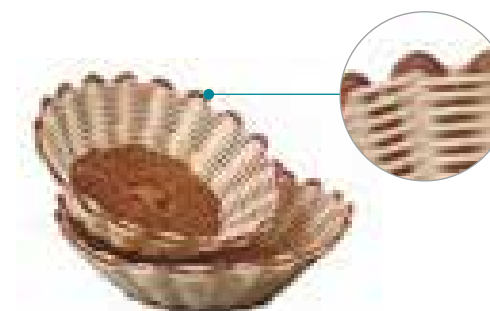

REF	Ø cm	H cm	
P100813	18,5	6,0	84
P100814	23	6,0	84

**P10082** Round basket  
*Cesta redonda*  
Corbeille ronde

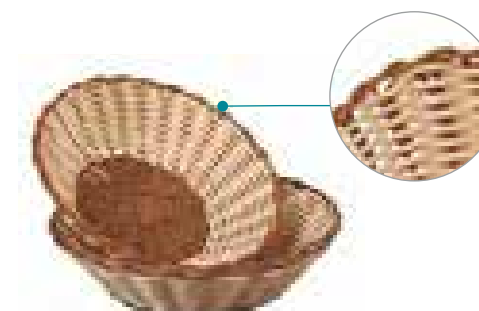

REF	Ø cm	H cm	
P100820	18,5	6,0	84
P100821	23	6,0	84

**P10090** Oval basket  
*Cesta oval*  
Corbeille ovale



REF	W x D x H cm	
P100900	30 x 23,5 x 7,5	36

## 15.2 Baskets and breadbaskets

Paneras y cestas  
Paniers et corbeilles

PP  
Polypropylene

**P10084** Rectangular basket  
*Cesta rectangular*  
Corbeille rectangulaire

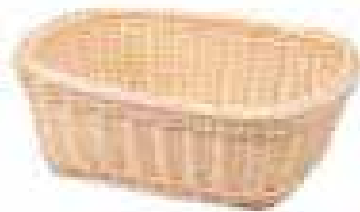

REF	W x D x H cm	
P100840	21,5 x 18 x 8	84
P100841	26 x 20 x 7,5	48

**P10085** Rectangular basket  
*Cesta rectangular*  
Corbeille rectangulaire



REF	W x D x H cm	
P100851	40 x 28,5 x 7	24

**P10086** Rectangular basket  
*Cesta rectangular*  
Corbeille rectangulaire



REF	W x D x H cm	
P100860	37 x 27 x 7	24
P100861	46 x 34 x 7	24
P100862	46 x 34 x 12	12

**P10087** Rectangular basket  
*Cesta rectangular*  
Corbeille rectangulaire



REF	W x D x H cm	
P100871	42 x 30 x 7	24

**P10088** Oval basket  
*Cesta oval*  
Corbeille ovale



REF	W x D x H cm	
P100880	18 x 12 x 6,5	60
P100881	23,5 x 15 x 7	60
P100882	28 x 14,5 x 7,5	36

**P10089** Oval basket  
*Cesta oval*  
Corbeille ovale



REF	W x D x H cm	
P100890	19 x 13 x 7	48
P100891	25 x 15 x 8	60
P100892	29 x 19 x 10	60

## Baskets and breadbaskets 15.2

Paneras y cestas  
Paniers et corbeilles

PP  
Polypropylene

**P10093** Cutlery dispenser  
*Cesta para cubiertos*  
Corbeille à couverts



REF	W x D x H cm	
P100931	30 x 11 x 7	96
P100932	30 x 11 x 7	96

**P10094** Cutlery dispenser  
*Cesta para cubiertos*  
Corbeille à couverts



REF	Ø cm	H cm	
P100940	13	14	36

**P10095** Rectangular buffet basket  
*Cesta buffet rectangular*  
Corbeille rectangulaire buffet

PE  
Polyethylene

PC  
Polycarbonate

GN 1/1



\* Lid  
Tapa  
Couvercle

REF	cm	Total H cm	Base H cm	
P100950	53 x 31,5	26,0	8,5	12
P100951	53 x 31,5	26,0	8,5	12
P100955*				6

**P10096** Round buffet basket  
*Cesta buffet redonda*  
Corbeille ronde buffet

PE  
Polyethylene

PC  
Polycarbonate



\* Lid  
Tapa  
Couvercle

REF	Ø cm	H cm	
P100960	40	30	24
P100965*			6



## 15.2 Place mats

Manteles individuales  
Sets de table

PVC

Place mats made of PVC + polyester.  
To clean please use a damp sponge or cloth.

Manteles individuales fabricados en PVC + poliéster. Para su limpieza se aconseja usar una esponja o trapo húmedo.

Sets de table fabriqués en PVC + polyester.  
Nettoyer à l'aide d'une éponge ou un chiffon humide.

### P92605 DECO place mats

Manteles individuales DECO  
Sets de table DECO

PVC

REF	cm	
P926051	45 x 30	20
P926052	45 x 30	20
P926053	45 x 30	20

Price / Precio / Prix : Pack 6 u.

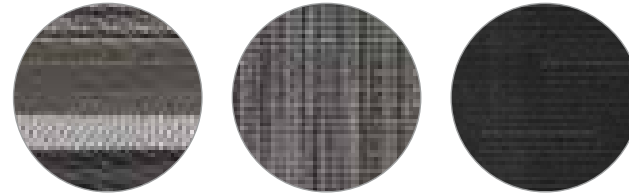

**Brown&Black Lines**  
Líneas marrones-negras  
Lignes marrons et noirs  
P926051

**Brown&Black**  
Marrón-negro  
Marron et noir  
P926052

**Black**  
Negro  
Noir  
P926053

### P9260 Place mat fine band

Mantel individual trama fina  
Set de table maille fine

REF	cm	
P926006	45 x 30	20
P926007	45 x 30	20
P926008	45 x 30	20
P926009	45 x 30	20

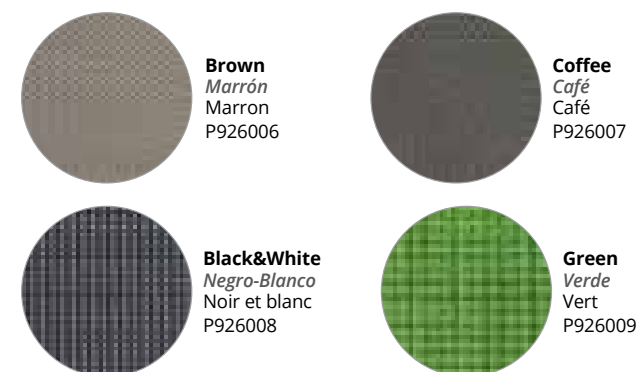

**Brown**  
Marrón  
Marron  
P926006

**Coffee**  
Café  
Café  
P926007

**Black&White**  
Negro-Blanco  
Noir et blanc  
P926008

**Green**  
Verde  
Vert  
P926009

### P926 Place mat wide band

Mantel individual trama gruesa  
Set de table maille épaisse

REF	cm	
P926002	45 x 30	20
P926003	45 x 30	20
P926004	45 x 30	20
P926005	45 x 30	20
P926010	45 x 30	20
P926011	45 x 30	20
P926012	45 x 30	20



**Orange**  
Naranja  
P926002

**Brown&Silver**  
Marrón-Plata  
Marron et Argent  
P926010

**Burgundy**  
Burdeos  
Bordeaux  
P926003

**Brown&Gold**  
Marrón-Dorado  
Marron et Doré  
P926011

**Black**  
Negro  
Noir  
P926004

**Silver**  
Plateado  
Argent  
P926012

**Brown&Black**  
Marrón-Negro  
Marron et noir  
P926005

## Flared sauce cups 15.3

Salseras  
Saucières

### P4100 Ramekin / Sauce container

Recipiente para salsas  
Récipient pour sauces

SS  
Stainless steel

NEW!



Pack 12u.

REF	Ø cm	H cm	ml	
P41005	6,2	2,75	45	12
P41006	5,8	4,50	75	12
P41007	7,4	5,20	135	12

### P4101 Ramekin / Sauce container

Recipiente para salsas  
Récipient pour sauces

PET

NEW!



Pack 12u.

REF		Ø cm	H cm	ml	
P41012	white	6,0	3,5	45	12
P41013	blanco	7,0	3,5	60	12
P41014	blanc	7,5	4,0	90	12
P41015	black	6,0	3,5	45	12
P41016	negro	7,0	3,5	60	12
P41017	noir	7,5	4,0	90	12
P41018	transparent	6,0	3,5	45	12
P41019	transparente	7,0	3,5	60	12
P41020	transparent	7,5	4,0	90	12

### P623 Snack bowl set or sauce bowl set

Portasalados o portasalsas  
Ensemble bols pour snacks ou sauces

SS  
Stainless steel



REF	UNI.	Ø cm/U	ml/U	
P623003	3	9	200	25

### P333 Gravy boat

Salsera  
Saucière

SS  
Stainless steel



REF	L	
P333010	0,10	72
P333020	0,20	36
P333035	0,35	24

# 15.3 Table accessories

Complementos de mesa  
Accessoires de table



**P638003** Table caddy. 3 Compartments  
Caddy de mesa. 3 Compartimentos  
Caddy de table. 3 compartiments

Galvanised steel  
Acero galvanizado  
Acier galvanisé

Wooden handle  
Asa de madera  
Manche en bois



REF	W x D x H cm	
P638003	26 x 10 x 12	6

**P638004** Table caddy. 4 Compartments  
Caddy de mesa. 4 Compartimentos  
Caddy de table. 4 compartiments

Galvanised steel  
Acero galvanizado  
Acier galvanisé

Wooden handle  
Asa de madera  
Manche en bois



REF	W x D x H cm	
P638004	26 x 18 x 12	6

# Table accessories 15.3

Complementos de mesa  
Accessoires de table

**P96700** Pepper mill-salt mill. Wooden  
Molinillos pimienta y sal. Madera  
Moulin à poivre et sel. Bois



REF	H cm	
P967007	12,5	1
P967008	15,0	1
P967009	19,5	50

**P967** Pepper mill-salt mill. Acrylic  
Molinillos pimienta y sal. Acrílico  
Moulin à poivre et sel. Acrylique



REF	Type / Tipo	H cm	
P967001	A	15,5	48
P967002	A	20,0	48
P967003	A	23,0	48
P967004	B	15,5	48
P967005	B	20,0	48
P967006	B	23,0	48

**P630** Number card holder  
Soporte para número "banquete"  
Support numéro "banquet"



REF	H cm	
P630010	10	1
P630020	20	50
P630030	30	50
P630040	40	50

**P632** Table number  
Número de mesa  
Numéro de table

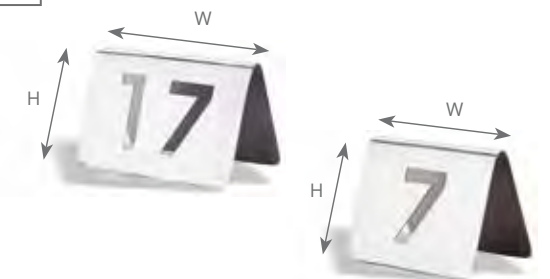

N. 1 - N. 30 \*\* number with 2 digits. \* number with 1 digit.  
\*\* número de 2 dígitos. \* número de 1 dígito.  
\*\* numero de 2 chiffres. \* numero d'un seul chiffre.

REF	W x H cm	
P63200 + NUM*	6,4 x 5,6	100
P6320 + NUM**	7,6 x 5,6	1

**P633** "Reserved" table sign  
Placa "Reservado"  
Plaque "reserve"

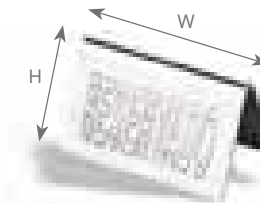

REF	Text	W x H cm	
P633000	RESERVADO	10 x 5	300
P633002	RESERVED	10 x 5	200
P633003	RESERVE	10 x 5	310

**P634** "Non-smoking" sign  
Placa "Prohibido fumar"  
Plaque "Défense de fumer"

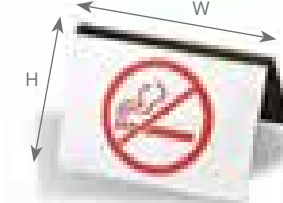

REF	W x H cm	
P634000	7,6 x 5,6	100

## 15.3 Table accessories

Complementos de mesa  
Accessoires de table

**P969** Stand for tray  
Soporte elevador  
Support pour plateau



REF	Ø cm	H cm	
P969000	25 / 20	19,0	12

**P968** Carry-skewers  
Porta pinchos  
Porte-brochettes



REF	Ø cm	H cm	
P968000	22	46	1

**P8621** Non slip oval serving tray  
Bandeja oval antideslizante  
Plateau antidérapant forme ovale



Black color  
Color negro  
Couleur noir

REF	cm	
P862100	68 x 56	6

**P9681** Skewer  
Pincho  
Brochette



Price 12 units box.  
Precio caja 12 unidades.  
Prix colis 12 unités.

REF	L cm	
P968135	35	1

**P874** Bill spike  
Pinchanotas  
Epingle porte-tickets



REF	Ø cm	H cm	
P874000	9	22	50

**P863** Large tray holder  
Soporte para bandejas de gran tamaño  
Support pour grands plateaux



Serving tray not included.  
No incluye bandeja.  
Plateau non inclus.

REF	W x D x H cm	
P863000	47 x 47 x 76,5	6

## Table accessories 15.3

Complementos de mesa  
Accessoires de table



**P650** St/Steel table-tidy  
Papelera sobremesa acero inox  
Receptacle à déchets de table



REF	Ø cm	H cm	
P650000	12	21	36

**P638** Water ashtray  
Cenicero de agua  
Cendrier à eau



REF	Ø cm	H cm	
P638000	11	5,5	100

**P625** Table crumber  
Pala recogemigas  
Pelle ramasse-miettes

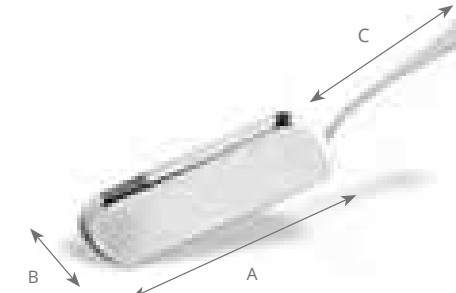

REF	A x B x C cm	
P625000	18 x 7 x 12,5	144

**P357** Napkin holder  
Servilletero  
Porte-serviettes



REF	H x W x D cm	
P357000	13 x 9,8 x 10	72

**P639** Deep ashtray  
Cenicero hondo  
Cendrier profond



REF	H x W x D cm	
P639000	2,5 x 12,5 x 12,5	200

See products on  
Ver productos en / Voir produits en page

P. 383

Melamine  
Melamina  
Mélamine



# 15.3 Menu holders

Portamenús  
Porte-menus

- Made of PVC.
- Pockets on each back cover.
- For DIN A4 and DIN A5 sheets.

- Fabricado en PVC.
- Bolsillos en contratapa interior.
- Para hojas DIN A4 y DIN A5.

- Fabriqué en PVC.
- Poches avec couverture intérieure.
- Pour feuilles DIN A4 et DIN A5.

## P2004 Elegance menu holder

Portamenús Elegance  
Porte-Menus Elegance

PVC



Up to 10 pages: cover back + 4 double inner pages + back cover front.

Para 10 páginas: 4 fundas dobles + 2 laterales.

Pour 10 pages: 4 feuilles plastiques doubles + 2 latérales.

REF	cm	Colour / Color	
P20041	33 x 24	Burdeos / Burgundy / Bordeaux	1
P20042	33 x 24	Negro / Black / Noir	1

## P636 Menu holder

Portamenús  
Porte-menu de table

SS  
Stainless steel

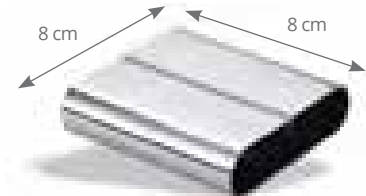

REF	H cm	
P636000	2	200

## P20066 Bill Holder

Porta facturas  
Porte-addition

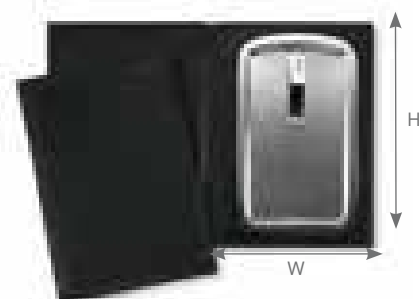

REF	W x H cm	Colour / Color	
P20066	24,5 x 17	Negro / Black / Noir	1
P20069	20 x 13,5	Negro / Black / Noir	1

## P20050 Elegance Bill holder

Porta blocs Elegance  
Porte-addition Elegance

PVC



REF	cm	Colour / Color	
P20050	23 x 13	Negro / Black / Noir	72

## P637 Bill holder

Platillo cambio  
Porte-addition

SS  
Stainless steel



REF	cm	
P637000	15,5 x 11	200
P637100	21,5 x 12,5	120

## P635 Card holder

Portatarjetas  
Porte-cartes

SS  
Stainless steel

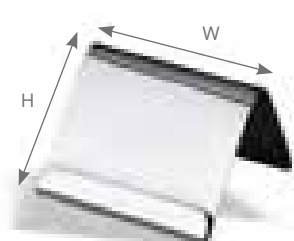

REF	W x H cm	
P635000	6,2 x 5,2	500

# Food & table service 15.4

Servicio de mesa  
Arts de table

## Plate Covers

Tapas para platos  
Couvercles à assiette

Plate covers keep food at its ideal serving temperature for improved customer satisfaction. Hemmed finger hole.

Las tapas para platos mantienen la comida a la temperatura ideal para servir. Se ofrecen con orificio central.

Les couvre-assiettes maintiennent les aliments à la température idéale de service pour améliorer la satisfaction du client. Trou ourlé pour passer le doigt.



## 62300 Stainless Steel Plate Covers

Tapas Acero inoxidable para platos  
Inox couvercles à assiette

SS  
Stainless steel

Stackable  
Apilable  
Empilable



Satin-finish keeps covers looking better longer  
El acabado satinado mantiene más tiempo el buen aspecto de las tapas  
Fini satin pour un attrait durable

REF	For / Para / Pour Ø cm	H cm	
62300	22,9 - 23,2	5,9	12
62301	23,3 - 23,5	5,9	12 NEW
62303	24,0 - 24,1	5,9	12
62305	24,6 - 24,8	5,9	12 NEW
62309	25,9 - 26,0	5,9	12 NEW
62311	26,5 - 26,7	5,9	12 NEW
62312	26,8 - 27,0	5,9	12
62313	27,1 - 27,3	5,9	12
62314	27,5 - 27,6	5,9	12 NEW
62315	27,8 - 27,9	5,9	12
62318	28,1 - 28,3	5,9	12
62321	29,1 - 29,2	5,9	12
62322	29,4 - 29,5	7,1	12 NEW
62323	29,7 - 29,8	7,1	12 NEW
62325	30,3 - 30,5	7,1	12 NEW
62326	30,6 - 30,8	5,9	12
62327	31,0 - 31,1	7,1	12 NEW
62328	31,3 - 31,4	7,1	12 NEW

## 918 Plastic Plate Covers

Tapas plástico para platos  
Plastique couvercles à assiette

PI  
Plastic

+ 93°C

Stackable  
Apilable  
Empilable

Clear  
Transparente  
Transparent

Dishwasher  
Lavavajillas  
Lave-vaisselle



REF	For / Para / Pour Ø cm	H cm	
918-13	21,6 - 23,2	6,7	12
1078-13	26,7 - 27,0	7,0	12
1100-13	28	7,2	12 NEW
1200-13	30,50	7,2	12 NEW

Ask about other available sizes  
Consultar otras medidas disponibles  
Consulter autres dimensions disponibles

# 16 Bar & coffee

Bar y cafetería  
Bar et cafétéria



## 16.1 BEVERAGE TROLLEY 488

CARRO BEBIDAS / TCHARIOT BOISSON

Cocktail trolley / Carro cocktail / Chariot cocktail	488
Liquor trolley / Carro licor / Chariot d'alcool	490

## 16.2 BAR 491

Wine Buckets / Cubiteras / Seaux à champagne	491
Cocktail Service / Cocteleria / Cocktail	496
Bar Mats / Alfombras para bar / Tapis de bar	498
Condiment Dispensers / Dispensador de condimentos Distributeur de condiments	499
Wine Complements / Complementos de vino / Accessoires du vin	500
Trays / Bandejas / Plateaux	501

## 16.3 TEA & COFFEE SERVICE 502

TÉ Y CAFETERÍA / THÉ ET CAFÉTÉRIA

Planet	502
Cosmos	504
Atlantis	504
Tea Pots / Teteras / Théières	505

## 16.4 BEVERAGE SERVICE 506

SERVICIO DE BEBIDAS / SERVICE À BOISSONS

Servers / Servidores / Verseuses	506
Pitchers / Jarras / Pichets	508

## 16.5 LIDSAVERS AND CUPDISPENSERS 510

DISPENSADORES DE TAPAS Y VASOS  
DISTRIBUTEUR DE COUVERCLES ET GOBELETS

# 16.1 Cocktail trolley

Carro cocktail / Chariot cocktail

**Trolley with an innovative and versatile design, with multiple storage spaces and a large work area.**

*Carro de diseño innovador y versátil, con múltiples espacios de almacenaje y una amplia zona de trabajo.*

Chariot au design innovant et polyvalent, avec de multiples espaces de rangement et un grand espace de travail.

**Carbon steel structure with anti-rust coating and satin black paint.**

*Estructura de acero al carbono con recubrimiento antioxidante y pintura negra satinada.*

Structure en acier au carbone avec revêtement antioxydant et peinture noire satinée.

**NEW!**

**It can be customized with a logo.**  
*Se puede personalizar con logo.*  
Personnalisable avec logo.

2 speed rails

**Elements of the work area in stainless steel.**

*Elementos del área de trabajo en acero inoxidable.*

Éléments de la zone de travail en acier inoxydable.

**Solid anti-humidity board with oak finish.**

*Tablero macizo antihumedad acabado roble.*

Panneau massif anti-humidité finition chêne.

**Drawer with metal runners**

*Cajón con guías metálicas*  
Tiroir avec guides métalliques

**Revolving casters, two with brakes**  
*Ruedas giratorias, dos con frenos*  
Roues giratoires, deux avec freins

**5 rails for hanging glasses**  
*5 railes para colgar copas*  
5 rails pour suspendre les verres



# Cocktail trolley 16.1

Carro cocktail  
Chariot cocktail

**Elements included:**

*Elementos incluidos:*

Éléments inclus :

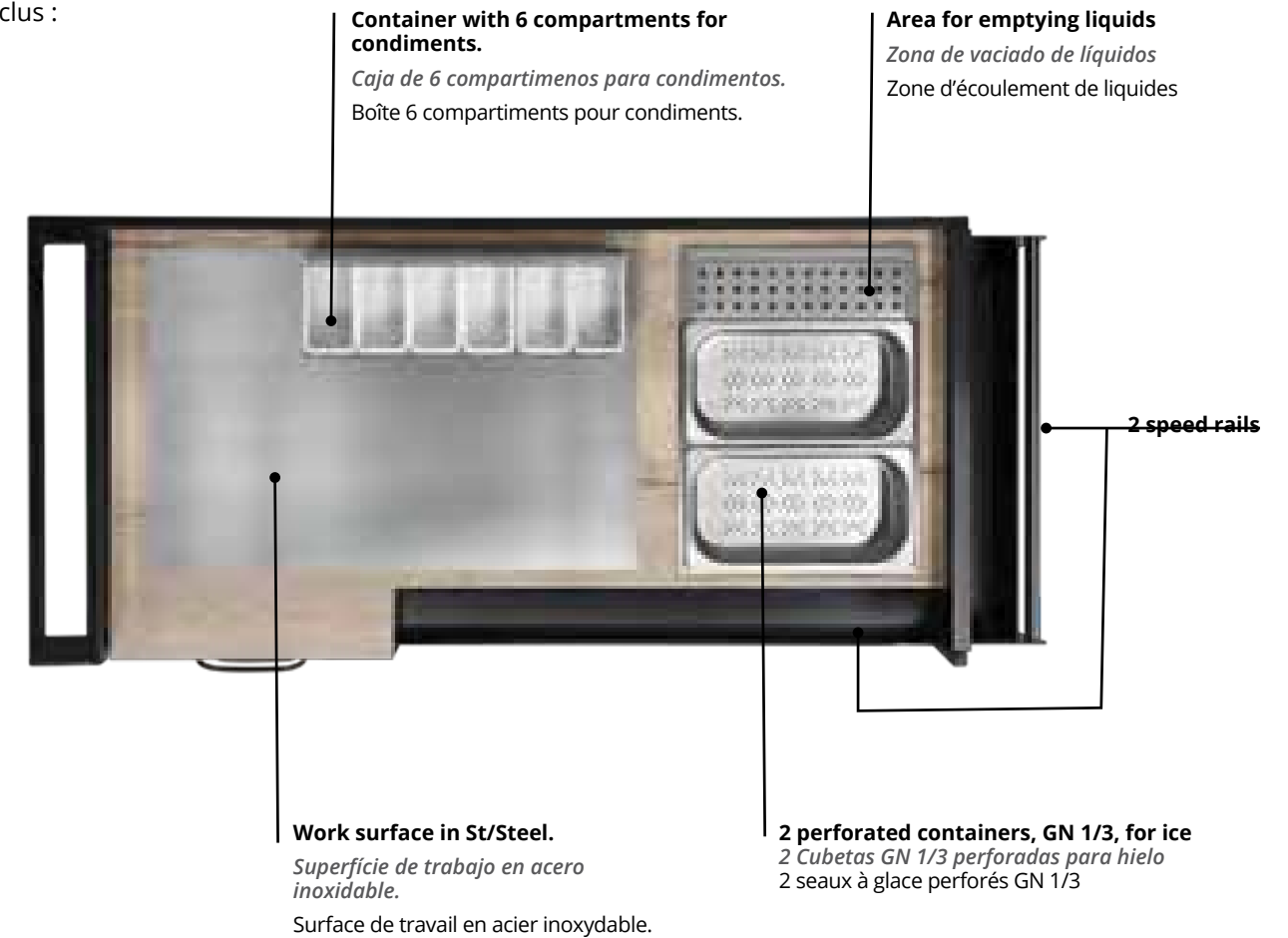

**P90910 Cocktail trolley with stainless steel work module**

*Carro cocktail con área de trabajo*  
Chariot à cocktails avec zone de travail

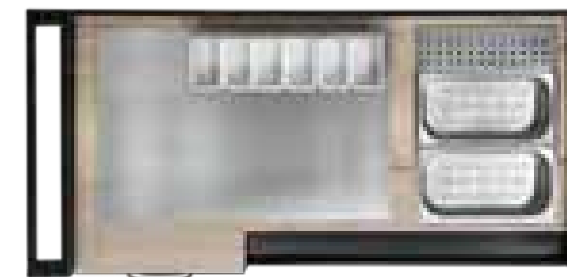

**P90911 Hanging bottle rack**

*Botellero colgante*  
Porte-bouteilles suspendu



Máximo 3 por carro.  
Máximo 3 por chariot.  
Maximum 3 par chariot.

REF	W x D x H cm	
P90910	132,5 x 63 x 98,5	1

REF	W x D x H cm	
P90911	59,5 x 12 x 23,5	1

## 16.1 Liquor trolley

Carro licor  
Chariot d'alcool



**NEW!**

Carbon steel structure with anti-rust coating and satin black paint.

Estructura de acero al carbono con recubrimiento antioxidante y pintura negra satinada.

Structure en acier au carbone avec revêtement antioxydant et peinture noire satinée.

REF	W x D x H cm	
P90930	91,5 x 63 x 98	1

2 speed rails

Solid anti-humidity board with oak finish.

Tablero macizo antihumedad acabado roble.

Panneau massif anti-humidité finition chêne.

3 rails for hanging glasses

3 railes para colgar copas

3 rails pour suspendre les verres

Area for rocks glasses.  
20-glass capacity.

Zona para vasos de licor.  
Capacidad para 20 vasos.

Zone pour verres à liqueur.  
Capacité pour 20 verres.

Shelves for mixers

Estanterías para mixers

Étagères pour mixers



## Wine Buckets 16.2

Cubiteras  
Seaux à champagne



**P972 Champagne bucket holder**  
Soporte de mesa para cubo champán  
Support de table pour seau à champagne

SS  
Stainless steel



dishwasher

**NEW!**



REF	Ø cm	H cm	Colour / Color	
P972201	21	20	Gold / oro / or	1
P972202	21	20	Black / negro / noir	1
P972203	21	20	Copper / cobre / cuivre	1

**P976 Hammered champagne bucket with handles**  
Cubo champán hammered con asas  
Seau à champagne Hammered avec poignées

SS  
Stainless steel

**NEW!**



REF	Ø cm	H cm	
P976210	21	20	1

**47620 Champagne bucket with fixed handles**  
Cubo champán con asas fijas  
Seau à champagne à poignées fixes

SS  
Stainless steel

**NEW!**



REF	Ø cm	H cm	
47620	21	19,7	1

## 16.2 Wine Buckets

Cubiteras  
Seaux à champagne



**P311F71** Conical champagne bucket with rings  
*Cubo champán cónico con anillas*  
Seau à champagne conique à anneaux



REF	Ø cm	H cm	
P311071	20	19,5	1

**P311F2** Champagne bucket with fixed handles  
*Cubo champán con asas fijas*  
Seau à champagne à poignées fixes



REF	Ø cm	H cm	
P311002	18	19	1

**P311F6** Champagne bucket with rings  
*Cubo champán con anillas*  
Seau à champagne à anneaux



REF	Ø cm	H cm	
P311006	18	19	1

**P326** Champagne bucket two bottles  
*Cubo champán dos botellas*  
Seau à champagne deux bouteilles



REF	Ø cm	H cm	
P326000	25	22	1

**P9762** Conical champagne bucket with handles  
*Cubo champán cónico con asas*  
Seau à champagne conique avec poignées



REF	Ø cm	H cm	
P976200	21	20	24

**P9763** Conical champagne bucket with rings  
*Cubo champán cónico con anillas*  
Seau à champagne conique à anneaux



REF	Ø cm	H cm	
P976300	19	19	24

## Wine Buckets 16.2

Cubiteras  
Seaux à champagne



**P312** Ice bucket with separative disk  
*Cubo para hielo con disco separador*  
Seau à glaçons avec disque de séparation



REF	Ø cm	H cm	
P312000	11	13	50

**P974** Double wall insulated cooler  
*Enfriador isotérmico doble pared*  
Rafraîchisseur isotherme double paroi



REF	Ø cm	H cm	
P974000	10,5	20	24

**P310** Ice cube bowl  
*Cubitera tipo ensaladera*  
Vasque



REF	Ø cm	H cm	Lts	
P310000	40	24,5	13	1

**P327** Ice cube bowl  
*Cubitera tipo ensaladera*  
Vasque



REF	Ø cm	H cm	Lts	
P327000	35	25	10	1

**P3110** St/Steel bucket-holder stand  
*Pie con portacubos acero inox*  
Pied porte-seau

\* Suitable for references  
*Compatible con los modelos*  
Adaptable pour les références  
P311.F2, P311.F6, P311.F71

\*\* For 2 bottles bucket  
*Para cubitera 2 botellas*  
Pour seau à champagne  
deux bouteilles



REF	Ø cm	H cm	
P311004*	18	67,5	1
P311020**	22	69,0	1

**47611** St/Steel bucket-holder stand  
*Pie con portacubos acero inox*  
Pied porte-seau



NEW!

REF	Ø cm	H cm	
47611	19,5	60	1



## 16.2 Wine Buckets

Cubiteras  
Seaux à champagne



dishwasher

**P988400** Plastic champagne bucket  
Cubitera de plástico  
Seau à champagne



REF	Ø cm	H cm	
P988400	21	21,5	6

**P988500** Bi-color plastic champagne bucket  
Cubitera bicolor plástico  
Seau à champagne bicolor



REF	Ø cm	H cm	
P988500	19	21	1

**P988600** Oval plastic champagne bucket  
Cubitera ovalada plástico  
Seau à champagne ovale



REF	W x D x H cm	
P988600	32,5 x 23,5 x 22	1

**P988700** Plastic champagne bucket  
Cubitera de plástico  
Seau à champagne



REF	Ø cm	H cm	
P988700	19,5	21	1

VOLLRATH

494

pujadas

## Wine Buckets 16.2

Cubiteras  
Seaux à champagne

**P988900** Oval plastic champagne bucket  
Cubitera ovalada plástico  
Seau à champagne ovale



REF	W x D x H cm	
P988900	44,5 x 41,5 x 25	1

**P9881** Conical acrylic champagne bucket  
Cubitera cónica acrílica  
Seau à champagne conique



REF	Ø cm	H cm	
P988100	20	18,5	12

**P9882** Oval acrylic champagne bucket  
Cubitera ovalada acrílica  
Seau à champagne ovale



\*3 BOTTLES  
\*3 BOTELLAS  
\*3 BOUTEILLES

REF	W x D x H cm	
P988200	27 x 20 x 20	12
P988300*	35 x 26 x 27	6

**P646** Champagne bucket holder  
Soporte de mesa para cubo champán  
Support de table pour seau à champagne



VOLLRATH

495

**P990** Wine cooler  
Manta enfriadora  
Rafrachisseur

Reversible:  
burgundy and silver

Reversible:  
burdeos y plata

Réversible:  
bordeaux et argenté



REF	cm	
P990000	35 x 18	55

Suitable with all champagne bucket but:  
Compatible con todos los modelos de cubos champán excepto con:  
Adaptable à tous les modèles sauf :  
ref. P326

REF	Ø cm	cm	
P646000	18	52 x 17	4

pujadas

# 16.2 Cocktail Service

Cocteleria  
Cocktail



## P330 Shaker

Coctelera  
Shakers Cocktail



REF	H cm	Lts	
P330035	18,0	0,35	72
P330050	20,5	0,50	72
P330070	23,5	0,70	48

## 46793 Bar shaker

Coctelera  
Shakers Cocktail



Mirror-finished stainless steel. Reinforced bases  
Acero inoxidable brillante. Bases reforzadas  
Acier inoxydable ultra-brillant. Bases renforcées

REF	Ø cm	H cm	ml	
46793	9,2	17,8	900	12
46791	8,64	11,4	4550	12

## 48070 Malt cup

Vaso para malteado  
Verre à milkshake



NEW!

Reinforced base. Ideal for malts, milkshakes, ice cream and more.  
Bases reforzadas. Ideal para malts, batidos, helados y más.  
Bases renforcées. Idéal pour les malts, les milkshakes, la crème glacée et plus encore.

REF	Ø cm	H cm	ml	
48070	10,2	17,1	900	12

See products on P. 457  
Ver productos en / Voir produits en page



# Cocktail Service 16.2

Cocteleria  
Cocktail



## P388 Ice tong

Pinza hielo  
Pince à glace



REF	L cm	
P388018	18,5	100

## 47104 Ice tong

Pinza hielo  
Pince à glace



REF	L cm	
47104	15,9	12

## 46790 Bar scoop

Cuchara de bar  
Bar scoop



NEW!

Sturdy handle provides a comfortable, reliable grip.  
El mango resistente proporciona un agarre cómodo y confiable.  
La poignée robuste offre une prise en main confortable et fiable.

REF		
46790		24

## 46787 Cocktail strainer

Colador para cócteles  
Passoire à cocktail

NEW!



Four prongs provide stability. Removable spring ensures easy and efficient cleaning.

Las cuatro puntas ofrecen estabilidad. El resorte extraíble garantiza una limpieza fácil y eficiente.  
Quatre broches assurent la stabilité. Le ressort amovible assure un nettoyage facile et efficace.

REF	W x D cm	
46787	11,5 x 15,7	12

## P319 Cocktail spoon

Cuchara batidora  
Cuillère à cocktail

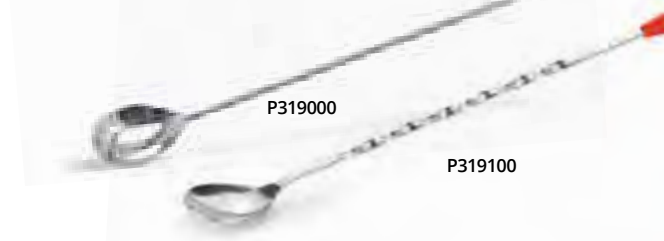

REF	L cm	
P319000	26,5	300
P319100	28,0	360

## P3181 Cocktail strainer

Colador gusanillo  
Passoire à cocktail

Four prongs provide stability. Removable spring ensures easy and efficient cleaning

Las cuatro puntas ofrecen estabilidad. El resorte extraíble garantiza una limpieza fácil y eficiente.

Quatre broches assurent la stabilité. Le ressort amovible assure un nettoyage facile et efficace.



REF	Ø cm	W x D cm	
P318100	7,6	11,7 x 15	144

## P616 Lemon squeezer

Exprime limones  
Presse citron



REF	Ø cm	
P616000	17	144

## P399 Jigger

Dosificador licor  
Mesure à cocktail

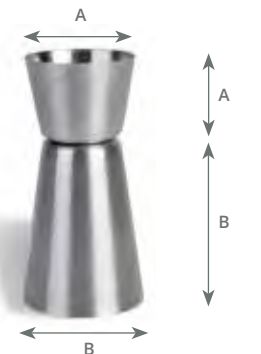

REF	Ø cm	H cm	ml	
P399000	A 3,7 B 4,1	A 2,8 B 5,7	25 50	200

## 16.2 Bar mats

Alfombras para bar  
Tapis de bar

**P26100** Bar mat  
Alfombra de bar para escurrido de copas  
Tapis égouttoir pour verres



They can be connected with each other forming bigger surfaces  
Se pueden conectar unas con otras formando mayores superficies  
Avec système de liaison pour composer une surface plus grande

REF	W x D x H cm	
P26100	30 x 30 x 1,20	1

**2331** Service mat  
Alfombra bar rectangular  
Tapis de service



Flexible thermoplastic rubber  
Caucho termoplástico flexible  
Caoutchouc thermoplastique flexible

REF	W x D x H cm	
2331-99	45,7 x 30,5 x 1,3	6

**3616** Bar keep  
Botella bar  
Bouteille de bar



Includes:  
1 neck + 1 jar + 1 lid + 6 assorted colored spouts.

El juego incluye:  
1 cuello + 1 jarra + 1 tapa + 6 picos estándar de diversos colores.

Le kit comprend:  
1 goulot + 1 bombonne + 1 couvercle  
+ assortiment de 6 becs verseurs standard de couleur.

REF	L	cm	
3616	0,47	25,7 x 9,20	12
3632	0,95	34,0 x 9,50	12
3648	1,40	38,1 x 16,5	6
3664	1,90	34,90 x 12,7	6
3628	3,80	43,2 x 14,0	6

## Condiment dispensers 16.2

Dispensador de condimentos  
Distributeur de condiments

**4741-06** Condiment Bar Dispenser. Black  
Caja condimentos negra  
Boîte à condiments



4741-06



4743-06

REF	W x D x H cm	Lts	Compart.	
4741-06	30,5 x 15,2 x 11,4	1,9	4	1
4743-06	45,7 x 15,2 x 15,6	2,8	6	1

- Not dishwasher safe.
- Transparent polycarbonate lid with automatic closure.
- The lid design increases the capacity and allows the item to be filled.
- Lids with holes allow utensils to be stored inside with the lid closed.
- Chiller plates are located on the bottom, keeping the condiments cool.

- No aptos para lavavajillas.
- Tapa policarbonato transparente con cierre automático.
- El diseño de la tapa aumenta la capacidad y permite llenar el artículo.
- Las tapas con orificios permiten mantener el utensilio dentro con la tapa cerrada.
- Las placas enfriadoras se colocan en la parte inferior, manteniendo los condimentos fríos.

- Adaptés au lave-vaisselle.
- Couvercle en polycarbonate transparent avec fermeture automatique.
- La conception du couvercle augmente la capacité et permet de remplir l'article.
- Les couvercles perforés permettent de garder l'ustensile à l'intérieur couvercle fermé.
- Les plaques de refroidissement sont placées sur la partie inférieure, en conservant les condiments froids.

**4747** Refreezable bottle for condiment holder  
Placa enfriadora para caja condimentos  
Plaque réfrigérante pour Bpîte à condiments



REF	W x D x H cm	
4747	13,2 x 11,4 x 2,9	6

**P3994** Condiment holder  
Caja condimentos  
Boîte à condiment



REF	W x D x H cm	L / Compart.	
P399400	30 x 14 x 8,5	0,45 x 4	12
P399500	38 x 14 x 8,5	0,45 x 5	12
P399600	45 x 14 x 8,5	0,45 x 6	12

## 16.2 Wine complements

Complementos de vino  
Accessoires du vin

**P985** Bottle stopper  
Tapón botella  
Bouchon bouteille



REF	Ø cm	H cm	
P985000	3	5,5	200

**46622** Bottle coaster  
Base para botellas  
Sous-bouteille



NEW!

REF	Ø cm	
46622	15,6	24

**46789** Waiter's corkscrew  
Sacacorchos camarero  
Limonadier



NEW!

REF	L cm	
46789	11,7	12

**P9845** Wall-mounted corkscrew  
Sacacorchos de pared  
Tire-bouchon mur



**P983** Ring stop drop  
Anillo anti-goteo  
Stop gouttes



REF	Ø cm	H cm	
P983000	4	2	1

**P984** Double-lever corkscrew  
Sacacorchos doble palanca  
Tire-bouchon double levier



REF	cm	
P984100	17 x 6	144

**47602** Tire-bouchon de serveur Pulltap's™  
Sacacorchos camarero Pulltap's™  
Pulltap's™ Kellnermesser



PATENTED

Double lever  
Palanca doble  
Double levier

Five turn Teflon® coated forged steel.  
Acero forjado revestido de Teflon®.  
Hoja de corte interior.  
Acier forgé revêtu de Teflon® cinq tours.

REF	Spirale / Espiral cm	L cm	
47602	5,1	11,7	10

REF	W x D x H cm	
P984500	8 x 26 x 32	6

## Trays 16.2

Bandejas  
Plateaux

**P619** St/Steel round serving tray  
Bandeja camarero en acero inox  
Plateau limonadier en acier inox



Mirror finished  
Pulido brillante  
Polissage brillant



REF	Ø cm	
P619002	35	1
P619000	40	1

**1474** Non-Skid Trays  
Bandeja camarero antideslizante  
Plateaux antidérapants

Non-slip  
Antideslizante  
Antidérapant

Black  
Negro  
Noir



REF	Ø cm	
1474-0606	35,6	12
1476-0606	40,6	12

**P956** Non slip serving tray  
Bandeja de camarero antideslizante  
Plateau de service anti-dérapant



Black and brown colour  
Color Negro i marrón  
Couleur noir i marron



REF	Ø cm	
P956035	35	12
P956040	40	12
P956135	35	12
P956140	40	12

**1612** Anti-Skid Mat Tray Accessories  
Mantel anti deslizante  
Tapis antidérapant



REF	cm	
1612-06	41 x 31,8	12
1420-01	Ø 31,8	12



SS  
Stainless  
steel

**P8920B** White creamer  
*Lechera blanca*  
Cremière blanche



REF	Lts	
P892015B	0,15	1
P892035B	0,35	1
P892060B	0,60	1

**P8920N** Black creamer  
*Lechera negra*  
Cremière noir



REF	Lts	
P892015N	0,15	1
P892035N	0,35	1
P892060N	0,60	1

**P8920R** Red creamer  
*Lechera roja*  
Cremière rouge



REF	Lts	
P892015R	0,15	1
P892035R	0,35	1
P892060R	0,60	1

SS  
Stainless  
steel

**P890** Tea pot with filter  
*Tetera*  
Théière



REF	Lts	
P890025	0,25	72
P890035	0,35	36
P890060	0,60	36

**P891** Coffee pot with filter  
*Cafetera*  
Cafetière



REF	Lts	
P891035	0,35	36
P891060	0,60	36
P891100	1,00	36

**P892** Creamer  
*Lechera*  
Cremière



REF	Lts	
P892015	0,15	72
P892025	0,25	72
P892035	0,35	36
P892060	0,60	36
P892100	1,00	36
P892150	1,50	24
P892200	2,00	24

**P893** Sugar bowl with lid  
*Azucarero con tapa*  
Sucrier avec couvercle



REF	Lts	
P893025	0,25	72
P893035	0,35	72

## 16.2 Cosmos

### P885 Tea pot with filter Tetera Théière



REF	Lts	
P885025	0,25	108
P885040	0,40	36
P885060	0,60	36

### P886 Coffee pot with filter Cafetera Cafetière



REF	Lts	
P886035	0,35	36

### P887 Creamer Lechera Cremière



REF	Lts	
P887015*	0,15	72
P887025*	0,25	72
P887060	0,60	36
P887100	1,00	24

\* Special handle design for refs. P887015 and P887025 for a better handling.  
Diseño especial asas refs. P887.015 y P887.025 para facilitar el manejo.  
Spécial design pour anses ref. P887.015 et P887.025 pour améliorer la prise en main.

## Atlantis

SS  
Stainless  
steel

### P880 Tea pot with filter Tetera Théière



REF	Lts	
P880035	0,35	50
P880050	0,50	50

### P881 Coffee pot with filter Cafetera Cafetière



REF	Lts	
P881100	1,00	1

### P882 Creamer Lechera Cremière



REF	Lts	
P882015	0,15	1
P882035	0,35	55
P882100	1,00	50

## Tea pots 16.3

Teteras  
Théières



### P23003 "Japan" tea pot Tetera "Japón" Théière "Japon"

CI  
Cast  
Iron



Cast iron.  
Hierro fundido.  
Fonte en fer.

Enameled inside.  
Esmaltado interior.  
Intérieur émaillé.



With St/Steel filter.  
Con filtro de acero inoxidable.  
Avec filtre en acier inoxydable.

REF	Filter / Filtro / Filtre Ø cm	Lts	
P23003	7,0	0,35	12
P23004	8,0	0,80	8

### P23015 "Kenya" tea pot Tetera "Kenya" Théière "Kenya"

CI  
Cast  
Iron



Cast iron.  
Hierro fundido.  
Fonte en fer.

Enameled inside.  
Esmaltado interior.  
Intérieur émaillé.



With St/Steel filter.  
Con filtro de acero inoxidable.  
Avec filtre en acier inoxydable.

REF	Filter / Filtro / Filtre Ø cm	Lts	
P23015	7,0	0,30	12

### P23008 "Nipon" tea pot Tetera "Nipon" Théière "Nipon"

CI  
Cast  
Iron



Cast iron.  
Hierro fundido.  
Fonte en fer.

Enameled inside.  
Esmaltado interior.  
Intérieur émaillé.



With St/Steel filter.  
Con filtro de acero inoxidable.  
Avec filtre en acier inoxydable.

REF	Filter / Filtro / Filtre Ø cm	Lts	
P23008	7,0	0,30	12
P23009	8,0	0,60	8

### P896 Coffee maker - herbal tea jug Jarra para infusiones Pot à infusions

SS  
Stainless  
steel

Cr  
Crystal



+100°C

To remove the glass it is  
necessary to unscrew.  
Para sacar el cristal es  
necesario desatornillar.  
Pour enlever le verre il est  
nécessaire de dévisser.

REF	Lts	
P896003	0,35	30
P896008	0,80	24

# 16.4 Servers

Servidores  
Verseuses



**P894** Air pot  
Termo con dosificador  
Verseuse à pompe



Rotative base.  
Base rotativa.  
Fond rotatif.

Inner side in St/Steel  
Interior en acero inoxidable  
Interieur en acier inoxydable

REF	Lts	
P894003	3,00	6
P894004	4,00	6
P894005	5,00	6

**P896** Airpot thermo inox with feeder  
Termo inox con dosificador  
Verseuse à pompe thermo inox



Rotative base.  
Base rotativa.  
Fond rotatif.

Inner side in St/Steel  
Interior en acero inoxidable  
Interieur en acier inoxydable

REF	Lts	
P896001	1,9	1
P896002	3,0	1

# Servers 16.4

Servidores  
Verseuses

**P337** Luxe insulated coffee pot  
Jarra termo luxe  
Pichet isolante luxe

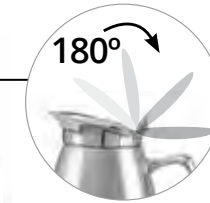

Inner side in St/Steel  
Interior en acero inoxidable  
Interieur en acier inoxydable

**IDEA!** Ideal for dishwasher.  
Ideal para lavavajillas.  
Ideal pour lave-vaisselle.

REF	Lts	
P337030	0,30	12
P337060	0,60	12
P337090	0,90	12
P337150	1,50	12
P337200	2,00	12

**P895** Vacuum jug  
Servidor termo  
Verseuse thermo



Inner side in St/Steel  
Interior en acero inoxidable  
Interieur en acier inoxydable



REF	Lts	
P895006	0,60	6
P895010	1,00	6
P895015	1,50	6
P895020	2,00	6

**P898** Thermo jug  
Jarra termo  
Piche isotherme



dishwasher



Inner side in glass  
Interior en vidrio  
Interieur en veurre

REF	Colour / Color	Lts	
P898001		1	1
P898002		1	1

**52172** Hot-N-Cold **SWIRLSERVE®**  
Servidor termo Hot-N-Cold  
Piche isotherme Hot-N-Cold



dishwasher

microwave



Looks like porcelain  
Aspecto cerámico  
Ressemble à de la porcelaine

With orange, brown, and white tabs allow easy differentiation.  
Con pestañas de color naranja, marrón o blanca que permiten diferenciar fácilmente.  
Avec pousoirs orange, marron ou blanc pour une meilleure différenciation.

REF	Colour / Color	Lts	
52172		0,60	12
52162		0,60	12
52170		1,25	12
52160		1,25	12
52174		1,90	6
52164		1,90	6

# 16.4 Pitchers

Jarras  
Pichets



## Pitchers

Jarras  
Pichets

**46599** Server without lid  
Jarra bombada con retén  
Pichet bombé avec retenu



REF	Lts	
46599	1,8	1

**P335** Server without lid  
Jarra bombada con retén  
Pichet bombé avec retenu



REF	Lts	
P335002	1,8	20

# Pitchers 16.4

Jarras  
Pichets

**P6464** Server  
Jarra  
Pichets

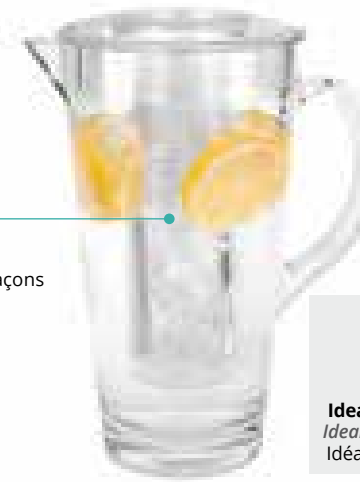

Tube for ice  
Tubo para hielo  
Tube pour les glaçons



Ideal for juices.  
Ideal para zumos.  
Idéal pour le jus.

REF	Lts	
P646400	1,9	6

**P6442** Server  
Jarra  
Pichets

**EXCLUSIVE**



Made of SAN.  
Fabricada en SAN.  
Fabriquée en SAN.

+80°C



REF	Lts	
P644200	1,00	12
P644240	1,40	12
P644275	1,75	12

**P6463** Polypropylene lid for stackable Server  
Tapa polipropileno para jarra apilable  
Couvercle polypropylène pour pichet empilable



REF	Lts	
P646300	1	24
P646310	1	24
P646301	2	12

**P649** Carafe tritan  
Jarra agua tritan  
Carafe en tritan



**EXCLUSIVE**



REF	Lts	
P649050	0,50	1
P649100	1,00	1

**P646** Stackable polycarbonate server without lid  
Jarra policarbonato apilable sin tapa  
Pichet polycarbonate Empilable sans couvercle



REF	Lts	
P646100	1	24
P646103	1	24
P646105	1	0
P646200	2	24

Fits only on the Stackable polycarbonate servers P646.  
Para Jarra policarbonato apilable sin tapa P646.  
Adaptables uniquement sur les pichets polycarbonate empilables P646.





# 16.5 Lidsavers and cupdispensers

Dispensadores de tapas y vasos  
Distributeur de couvercles et gobelets



## LIDSAVER™ 3

### SANITARY SOLUTIONS

- Sanitary dispensing system helps eliminate contamination from excess handling.
- Keeps operations clean and tidy, addressing major consumer concerns about health and well-being.

### SOLUCIONES HIGIÉNICAS

- El sistema de dispensado higiénico previene la contaminación por manipulación excesiva.
- Mantiene las operaciones limpias y ordenadas y responde a las inquietudes de los consumidores en cuanto a salud y bienestar.

### SOLUTIONS HYGIÉNIQUES

- Ce système de distribution hygiénique empêche la contamination causée par une manipulation excessive.
- Maintient les locaux propres et ordonnés, répondant ainsi aux principaux soucis des clients en ce qui concerne la santé et le bien-être.

### CUSTOMER BENEFITS

- A welcome environment that is clean and tidy.
- Noticeably more hygienic service fosters customer goodwill.
- Simple-to-use design allows customers to fill beverages and put on a lid using only one hand.

### BENEFICIOS PARA LOS CLIENTES

- Un ambiente agradable, limpio y ordenado.
- Un servicio notablemente más higiénico fomenta la buena voluntad de los clientes.
- El diseño fácil de usar permite a los clientes llenar bebidas y poner la tapa usando una sola mano.

### AVANTAGES POUR LE CLIENT

- Un cadre accueillant, propre et ordonné.
- Un service de toute évidence plus hygiénique dope les ventes.
- Utilisation simple et facile qui permet aux clients de remplir leur gobelet de boisson et de mettre le couvercle d'une seule main.

### COST SAVINGS

- Fewer wasted lids adds up to more savings.
- Counters are kept free of stacks of new lids and messy rejected lids, requiring less labor for cleanup.

### AHORROS

- Menos pérdidas de tapas significan más ahorro.
- Los mostradores se mantienen libres de pilas de tapas nuevas y tapas rechazadas, desordenadas, lo cual se traduce en menos trabajo de limpieza.

### ÉCONOMIES

- Moins de couvercles gaspillés, ce qui se traduit par plus d'économies.
- Les comptoirs ne sont pas encombrés par des piles de couvercles neufs et des couvercles usagés et sales, ce qui demande moins de main-d'oeuvre pour le nettoyage.

### UP TO 30% COST SAVINGS

AHORRAR HASTA UN 30% DE LOS COSTES  
ÉCONOMISEUR DE 30% DES COÛTS



# Lidsavers and cupdispensers 16.5

Dispensadores de tapas y vasos  
Distributeur de couvercles et gobelets



## Lidsaver™ 3

### Assembly Montaje Montage

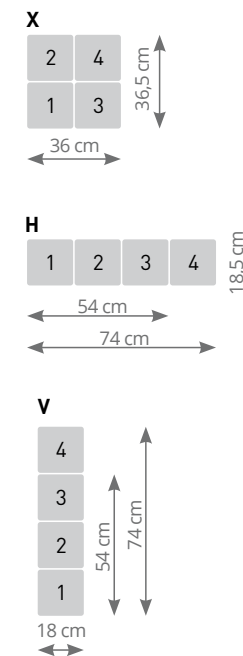

### T1 (L)

Lids / Tapas / Couvercles  
LS03 K / LS03 M

Model / Modelo	Code / Código
Berry™ DLT1310 Domed	AB
Berry™ DLT1310SS	AC
Berry™ DLT1402 Domed	AD
Berry™ DLT1402SS	AE
Berry™ DLT1408 Domed	AF
Berry™ DLT1408SS	AG
Dart® 16EL	AJ
Dart® 16LCDH	AK
Dart® 16RCL	AL
Dart® 16SL	AM
Dart® 20SL	AN
Dart® 20SLR	AO
Dart® 32SL	AP
Dart® 32SLR	AQ
Dixie® 9542	AR
Dixie® 955	JY
Dixie® TP9542	AS
Dixie® TP9550	JZ
International Paper LCRS 32	AT
International Paper LCTS 44	AU
Sweetheart® LGX12R	AY
Solo® 626	AZ
Solo® DL626	BB
Solo® DLR642	BC
Solo® LD16A	BD

### T2 (C)

Cup dispenser  
Dispensador vaso  
Distributeur de gobelets

REF	Code / Código	Type / Tipo
INC-80	A	Plastic / Plástico
CADJ-3	D	St/Steel / Inox

### T3 (S)

Straw dispenser  
Dispensador cañas  
Distributeur de pailles

REF	Code / Código
S1	S

### T4 (P)

Condiment pocket  
Apartado para condimentos  
Casier à condiments

REF	Code / Código
P1	P

For other lid models, consult your dealer.  
Para otros modelos de tapa, consultar a su comercial.  
Pour d'autres modèles de couvercles, consulter votre agent.



### LS03 K Lids and cups dispenser display Mueble dispensador tapas y vasos Meuble distributeur couvercles et gobelets

REF + TYPE + CODE K4V-LLCC-AB-AD-A-A



REF	Tipo / Type	Code / Código
K1	L	T1
K2H	LL	T1 + T1
K2V	LC	T1 + T2
	LP	T1 + T4
	LLL	T1 + T1 + T1
K3H	LCC	T1 + T2 + T2
K3V	LCS	T1 + T2 + T3
	LCP	T1 + T2 + T4
	LCCC	T1 + T2 + T2 + T2
K4H	LCCS	T1 + T2 + T2 + T3
K4V	LCCP	T1 + T2 + T2 + T4
	LLCC	T1 + T1 + T2 + T2
	LCCC	T1 + T2 + T2 + T2
K4X	LCCS	T1 + T2 + T2 + T3
	LCCP	T1 + T2 + T2 + T4
	LLCC	T1 + T1 + T2 + T2



### LS03 M Vertical lids dispenser display Mueble dispensador tapas vertical Meuble distributeur couvercles vertical

REF + CODE M2V-LL-AB-AE



REF	Code / Código	H cm
M1-L	+T1	18,5
M2V-LL	+T1 + T1	36,5
M3V-LLL	+T1 + T1 + T1	54,0
M4V-4L	+T1 + T1 + T1 + T1	74,0

# 16.5 Lidsavers and cupdispensers

Dispensadores de tapas y vasos  
Distributeur de couvercles et gobelets

**KDS** Lids and cups dispenser organizer display  
Mueble dispensador tapas y vasos con organizador  
Meuble distributeur couvercles et gobelets avec organisateur



REF	Code / Código	H cm	📦
K1LLDS	T1	42,5	1
K2VLLCLS	T1 + T2	60,5	1
K2VLLLS	T1 + T1	60,5	1
K3VLLCLS	T1 + T2 + T2	78,5	1

## Lidsaver™ 3 MINI

### T5 (L)

Lids / Tapas / Couvercles  
LS03J / LS03M

Type / Tipo	Code Código
Dart® Solo® P150	M9
Dart®/Solo® PL2	N1
Natureworks Inego PLA 3.085/310	YQ
International Paper LCM-12S	D9
International Paper LCWS12	XE
International Paper LCRS 12	EQ
International Paper LHSL-8	XK
Pactiv YLP10C	ZD
Solo® L10BL	ST
Solo® PL4	ZN
Solo® TL3-8	IT
Solo®TLRN38	ZM
Sweetheart® DLX8R	GV
SUP-10D	YT
Quick 6 Oz. BIS-H	YH
WinCup® 6L STYROLID	VG

For other lid models, consult your dealer.  
Para otros modelos de tapa, consultar a su comercial.  
Pour d'autres modèles de couvercles, consulter votre agent.

**LS03** Lids In-counter dispenser  
Dispensador encastrable tapas  
Distributeur encastrable couvercles

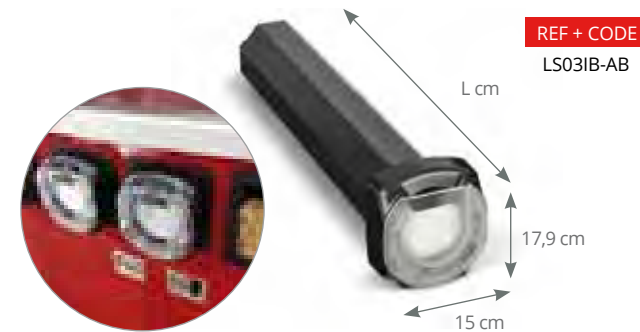

REF	Code Código	Posiciones Posiciones	L cm	For / Para / Pour cm	📦
LS03IB	T1	H	58,5	8,3 - 9,5	1
LS03IVB	T1	V	58,5	8,3 - 9,5	1
LS03PB	T1	H	58,5	9,7 - 12,1	1
LS03PVB	T1	V	58,5	9,7 - 12,1	1
LS03IS18B	T1	H	45,5	8,3 - 9,5	1
LS03PS18B	T1	H	45,5	9,7 - 12,1	1

**LS03 J** Mini lid dispenser display  
Mueble dispensador mini tapas  
Meuble distributeur mini couvercles



REF	Type / Tipo	Code / Código	B x H cm
J1	L	T5	13,5 x 19,1
J2V	LL	T5 + T5	13,5 x 36,0
J2H	LL	T5 + T5	28,5 x 19,1
J3V	LLL	T5 + T5 + T5	13,5 x 52,5

**LS03 M** Mini lid In-counter dispenser  
Dispensador encastrable mini tapas  
Distributeur encastrable mini couvercles



REF	Code / Código	Posiciones Posiciones	L cm	📦
LS03MS18B	T5	H	45,5	1
LS03MVS18B	T5	V	45,5	1

For / Para / Pour : 4,4 - 8,3 cm

# Lidsavers and cupdispensers 16.5

Dispensadores de tapas y vasos  
Distributeur de couvercles et gobelets

**RSCL** Lids and cups dispenser  
Dispensador vasos y tapas  
Distributeur gobelets et couvercles



REF	L cm	Ø cm	For / Para / Pour cm	📦
RSCL-4	38	101,5	-	1
LD2-2	11	65,0	10,5	1
LD3-2	13	65,0	12,4	1
PLC-1	8	65,5	5,7 - 7,3	1
PLC-2	9,5	65,5	7,3 - 8,9	1
PLC-3	11	65,5	8,9 - 10,5	1

**INC / CADJ** Cup dispenser  
Dispensador vaso  
Distributeur de gobelets



REF	L cm	Ø cm	For / Para / Pour cm	📦
INC-80	58,5	13,5	5,7 - 12,1	1
INC-80S18	46,0	13,5	5,7 - 12,1	1
CADJ-1	56,0	13,5	6,4 - 8,9	1
CADJ-2	56,0	14,5	7,6 - 9,8	1
CADJ-3	56,0	17,5	7,6 - 11,7	1

**3825** Straw dispenser  
Dispensador de pajitas  
Distributeur de pailles



REF	W x D x H cm	📦
3805-06	31 x 36,7 x 17,8	1
3820-28	32 x 14 x 18	1

NEW!

# 16.5 Lidsavers and cupdispensers

Dispensadores de tapas y vasos  
Distributeur de couvercles et gobelets

**G58807** Countertop dispenser  
Dispensador de mostrador  
Distributeur de comptoir



4 adjustable cup dispenser  
4 T-lid holder  
1 straw holder

Dispensador ajustable de 4 tazas  
Soporte para 4 tapas en T  
1 portapajillas

4 distributeurs de tasses réglables  
4 porte-couvercle en T  
1 porte-pailles

REF	W x D x H cm	
G58807	36,2 x 62,5 x 80,5	1

**4830-06** Three-tier self-serve dispenser  
Dispensador autoservicio de tres niveles  
Distributeur libre-service à trois niveaux



REF	W x D x H cm	
4830-06	14,3 x 30 x 35	1

**4842** Self-Serve dispenser system  
Dispensador auto-servicio  
Système distributeur libre-service



**CTCL-4B** Four-compartment countertop cup and lid organizer  
Organizador de encimera de tazas y tapas con cuatro compartimentos  
Présentoir de comptoir à quatre compartiments pour tasse et couvercle



REF	W x D x H cm	
CTCL-4B	15,4 x 57,2 x 53,3	1

**CTFWH-8B** Eight compartment flatware organizer  
Organizador de cubiertos de 8 compartimentos  
Range-couverts à 8 compartiments



REF	W x D x H cm	
CTFWH-8B	25,6 x 46 x 43,7	1

**IDEA!** Ideal for flatware, tea, condiment packets, salt, pepper, and products with high-volume usage.  
Ideal para cubiertos, te, condimentos, sal, pimienta y para todo tipo de productos de mucha rotación.  
Idéal pour couverts, thé, condiments, sel, poivre et toute sorte de produits à usage intensif.

REF	W x D x H cm	
4806-01	13 x 28,5 x 11	1 NEW
4806-06	13 x 28,5 x 11	1
4842-01	14,3 x 40,6 x 35,2	1 NEW

# Lidsavers and cupdispensers 16.5

Dispensadores de tapas y vasos  
Distributeur de couvercles et gobelets

**CTNO** Condiment dispensers  
Dispensadores de condimentos  
Distributeurs de condiments



REF	W x D x H cm	Capacity Capacidad Capacité	Napkin / Servilletas Serviettes cm	
CTNO-06*	24,5 x 49,0 x 38,5	100	12,5 x 16,5 11,5-12,5 x 16,5	1

**LDS** Condiment dispensers  
Dispensador de condimentos  
Distributeur de condiments



REF	W x D x H cm	
CFIFO-4	42,2 x 25,6 x 42	1 NEW
LDS-4CUP*	29,5 x 53,5 x 51,5	1
CTC-3X2V**	29 x 27 x 41,5	1
LDS-3	18,4 x 61 x 24,4	1 NEW



\* For lids and cups  
Para tapas y vasos  
Pour couvercles et gobelets  
Ø 12 cm

\*\*Adjustable dividers  
Divisores ajustables  
Séparateurs réglables

# Index

Índice  
Index

# english

ITEM	PAGE
ADAPTOR BAR.....	192, 195
ADJUSTABLE DISH CADDY.....	261
AIR POT.....	506
ANGLED ADAPTOR PLATE.....	329
ANTIMICROBIAL.....	102, 103
ANTI-SKID MAT TRAY ACCESSORIES.....	501
APPLE CORER.....	138
ASHTRAY.....	383, 483
BAIN MARIE.....	50, 313, 318, 433
BAKERY DISPLAY CASES.....	396, 397
BAR KEEP.....	498, 500
BAR KEEP®.....	498
BAR MATS.....	498
BAR SCOOP.....	497
BARRIER.....	450
BASE FOR BURNER.....	85
BASKET, BREAD.....	473-477
BASKET, WIRE.....	390
BEVERAGE TROLLEY.....	489, 490
BILL SPIKE.....	482
BIRD NEST MOULD.....	100
BLACK FIRST.....	80
BLACK PRO.....	78-79
BLACK SERIES.....	60
BLACK STEEL SPANISH PAELLA PAN.....	84
BLACKBOARDS.....	451
BOILER.....	154
BOWL.....	221, 334, 337-339, 344-346, 348, 353-354, 356, 359-360, 362-363, 365-370, 380, 395, 437
BOWLS, ANGLED BEEHIVE.....	437
BOWLS, DOUBLE WALL INSULATED SERVING.....	221, 437
BPA FREE GASTRONORM PAN.....	204, 205
BREATH GUARDS, MOBILE.....	394
BREATH GUARDS, MOBILE ACRYLIC.....	394
BRONZE COOKWARE.....	400
BRUSH.....	159
BUCKET WITH BASE.....	146
BUCKET-HOLDER STAND.....	495
BUCKET-HOLDER STAND.....	493
BUFFET CUBIC. BUFFET TROLLEY.....	425-427
BUFFET CUBIC. CUBES & SHELVES.....	421
BUFFET CUBIC. DISPLAY CASE.....	419, 422, 423
BUFFET DISPLAY.....	339, 340, 395
BUFFET FUEL.....	432
BUFFET STATION.....	317
BUFFET WINE COOLER. CUBIC.....	418
BUTTER SPREADER.....	114
CAKE DIVIDER.....	160
CAKE MOULD.....	163-165, 169, 182
CAKE SERVER.....	114, 442, 444
CAKE STAND.....	161
CAN OPENER.....	138
CARAMEL CREAM MOULD.....	169
CARAMELIZER.....	160
CARD HOLDER.....	484
CARRY-SKEWERS.....	35, 482
CASSEROLE.....	60
CASSEROLE BLACK SERIES.....	60

ITEM	PAGE
CAST IRON MINIATURE.....	460-461
CATERING BAGS.....	216, 217
CAYENNE®.....	312-313
CAYENNE® WARMERS & RETHERMALIZERS.....	310-314
CENTURY.....	58, 59
CEREAL DISPENSER.....	435
CHAFERS.....	428-431
CHAFERS ACCESSORIES.....	429, 432, 434
CHAFERS, ECONOMY.....	431
CHAFERS, INTRIGUE®.....	429
CHALKMARKERS.....	451
CHAMPAGNE BUCKET.....	491, 492, 494, 495
CHAMPAGNE STOPPER.....	500
CHARCOAL OVEN.....	29-31
CHECK MINDER.....	124
CHIMNEY.....	28
CHINESE COLANDER.....	116
CHIP BAGGER.....	111
CHOCOLATE FOUNTAIN.....	318
CLEAR GN LIDS.....	341, 397
CLEARING TROLLEY.....	245, 246
CLIP TAGS.....	228, 234, 235, 239, 240
COCKTAIL SERVICE.....	496, 497
COCKTAIL SPOON.....	497
COCKTAIL STRAINER.....	497
COFFE MAKER.....	505
COFFE POT.....	502-505
COLANDER.....	115-116
COLANDER.....	117
COLORLED COOKWARE.....	55
COMPLETE KITS OF SHELVING.....	268-277
CONDIMENT HOLDER.....	499
CONFECTIONERY FUNNEL.....	162
CONICAL SAUCEPAN.....	46, 50, 59
CONTACT GRILL.....	301
COOL • LINE.....	55, 71
COOLING PLATE.....	433
CORKSCREW.....	500, 502
COUNTER-TOP DISPENSER.....	258, 427
COUNTERTOP MIXERS.....	302
COUSCUS SET.....	51
COVERS, PLASTIC PLATE.....	485
COVERS, PLATE.....	485
CREAMER.....	502-504
CRÊPE MAKER.....	294
CUBE CUTTER.....	135
CUBED-GLASS DISPLAY CASES.....	321
CUP.....	221, 369
CUTLERY BIN.....	223
CUTLERY DISPENSER FOR SERVING TROLLEY.....	246
CUTTING BOARD.....	140-142
CUTTING BOARD TABLE.....	140-142
CUTTING BOARD VIOLET.....	142
DELIVERY BACKPACKS.....	218-219
DICER & SLICER.....	129, 130
DISHES.....	221, 334-336, 338, 344-350, 353-357, 360-361, 368, 370
DISHES, COLORED.....	336, 357
DISPENSER AND DISPOSABLE COVERS.....	250

# Index

Índice  
Index

# english

ITEM	PAGE
DISPENSERS.....	162, 434, 435
DISPENSING SOLUTIONS.....	510-515
DISPLAY CABINET.....	402
DISPLAY COOKWARE.....	408-411
DISPLAY SLATES.....	466-467
DISPLAY STANDS.....	386, 391-393
DISPLAY TRAY.....	335, 340, 341, 345, 351, 371, 380, 395, 420, 467
DISPLAYER MELAMINE BOWLS. CUBIC.....	421
DOUBLE CUTTER.....	158, 166-168
DOUBLE FAST-FOOD TRAY TROLLEY.....	256
DOUBLE WALL INSULATED COOLER.....	493
DREGDERS.....	123
DROP-IN.....	289, 293
EGG RING.....	119
EGG SLICER.....	138
ELECTRIC HEATING UNIT FOR CHAFING DISH.....	432
ELECTRIC SLICING MACHINE.....	303
ELEGANCE.....	355
ENAMELLED GAS BURNIER.....	85
ENAMELLED STEEL MINATURES.....	458
ENAMELLED STEEL PAELLA PAN.....	84
EPP BOX.....	213
FAST-FOOD TURNER.....	113
FISH SCALER.....	124
FISH TURNER.....	99, 113
FLAP IDENTIFICATION.....	227
FLAP-RACK®.....	227, 228
FLARED SAUCE CUPS.....	479
FLATWARE BASKET.....	237
FOOD PAN ....	155, 201, 318, 345, 349-350, 355, 365, 370, 409, 429, 438, 461
FOOD-PROCESSORS.....	302-303
FORK.....	101, 103, 441-443, 446
FRENCH FRY CUTTER.....	131
FRENCH STYLE SAUCEPAN.....	49
FRUIT & VEGETABLE SLICER.....	133
FRY PAN "LYONNAISE".....	83
FRY PAN ALUMINIUM.....	73-76
FRY PAN BLACK SERIES.....	78
FRY PAN BLINIS.....	76
FRY PAN CAST ALUMINIUM.....	78-80
FRY PAN COOL • LINE.....	71
FRY PAN CRÊPE.....	79, 80
FRY PAN DEEP ENAMELLED WITH HANDLES.....	84
FRY PAN IDEA.....	72
FRY PAN MULTIMETAL.....	69
FRY PAN PUJADAS 1921.....	81
FRY PAN ST/STEEL.....	70-72
FRY PANS.....	62-83, 408
FRYER.....	295
FUNNEL.....	118, 162
GASTRONORM CONTAINERS (MELAMINE).....	374-378
GASTRONORM CONTAINERS (POLYCARBONATE).....	202-203
GASTRONORM CONTAINERS (POLYPROPYLENE).....	206-207
GASTRONORM ENAMELLED STEEL.....	399
GASTRONORM FOR DEFROST TROLLEY.....	254
GASTRONORM SANDWICH BOTTOM.....	189, 199, 401
GASTRONORM ST/STEEL.....	194-197

ITEM	PAGE
GASTRONORM STAND.....	198, 223, 379, 417
GASTRONORM VIOLET.....	208
GLASS.....	221, 356, 457, 496
GLOVES.....	149
GN BAMBOO BOX.....	391
GN HERMETIC LID.....	33, 197
GN HERMETIC LID EASY OPEN.....	197
GN PASTRY PAN.....	154
GN TRANSPORT TROLLEY.....	250-252, 258
GRANITE-SLATE DISPLAYER.....	373
GRATER.....	120-121
GRAVY BOAT.....	479
GRID GN.....	92
GRID PASTRY.....	88
GRILL.....	79, 80
GRILL.....	27-37
GRILLBOX LID.....	28
GRIPPER.....	28, 95, 99, 111, 113-114, 144, 342, 442, 444, 465, 497
HEART RING MOULD.....	168
HEATING LAMPS.....	315-317
HEATING PLATE.....	318
HEMISPHERICALD MOULD.....	155
HEXAGON MOULD.....	168
HOOK.....	118
HOT CUPBOARD.....	321
HOT TRAY WARMER.....	257, 321
HOT-PLATE WITH HANDLES.....	79
ICE BUCKET.....	493
ICE CREAM CONTAINERS.....	153
ICE CREAM CUP.....	153
ICE CREAM SCOOP.....	152
ICE-CREAM CHURN.....	326
ICE-CREAM PARLOUR.....	150-151, 322-327
INDUCTION HOBS.....	284-293
INFORMATION SIGN.....	450
INOX-PRO.....	46-53
INSTITUTIONS.....	220-223
INSULATED COFFE POT.....	507
ISOTHERMAL TRAY.....	256
JIGGER.....	497
JUICE DISPENSER.....	435
KITCHEN BOWL.....	155
KITCHEN TIMER ALARM.....	147
KITS. CUBIC.....	415-417
KNIFE.....	441, 443, 446
KNIFE / WHEEL (SPARE PART).....	138
LADLE.....	98, 369, 441-445
LARGE TRAY HOLDER.....	482
LEMON SQUEEZER.....	497
LID FOR BREAKFAST CUP.....	221
LID FOR COOKWARE.....	33, 49, 399
LID GN.....	33, 197, 203, 205, 207-208
LID INOX-PRO.....	49
LID RACKS.....	236
LIDSAVER®.....	510-515
LOBSTER CRACKER.....	449
MANDOLINES.....	139
MANUAL FOOD PROCESSORS.....	129-139

ITEM	PAGE	ITEM	PAGE
MARBLE OBLONG DISPLAY PLATE.....	373	PLACE MATS.....	478
MATS.....	149	PLASTIC CHAMPAGNE BUCKET.....	494-495
MEASURING CUP.....	145, 146	PLATE COVERS.....	485
MEASURING CUPS.....	145	PLATING TONGS.....	107
MEASURING JUG.....	146	POLINORM® LID.....	197, 203, 205, 207
MEASURING JUG.....	146	POLYCARBONATE TUBE.....	174
MEASURING SCOOP.....	144	POLYPROPYLENE BASKETS.....	474-477
MEASURING SPOON.....	144, 145	PORTION CONTROL DISPENSER.....	162
MEAT BEATER.....	119	POT-GRABBER.....	149
MEDITERRANEAN.....	356	PUJADAS 1921. ULTRALIGHT WEIGHT CAST IRON INDUCTION.....	81
MELAMINE FOR PRESENTATION.....	334-383	PVC RIBBON.....	168
MELAMINE MINIATURES.....	380-382	RACK (BIG TRAYS).....	240
MELAMINE SLIM.....	376-377	RACK (CLOSED SYSTEM).....	234, 235
MENU HOLDER.....	484	RACK (DISHES).....	238-240
METAL WIRE BASKET.....	471	RACK (FLATWARE).....	236, 237, 477
METALLIC BRUSH.....	124	RACK (ISOTHERMAL TRAYS).....	240
MICRO-WAVES.....	294	RACK (OPENED SYSTEM).....	230-233
MILK DISPENSER.....	434, 435	RACK (UNIVERSAL).....	236
MINIATURE CAST ALUMINIUM.....	459	RAMEKIN.....	145, 337, 380, 463, 477, 479, 480
MIRAGE®.....	292-293, 306-309	RECTANGLE FOR BAKING SHEETS.....	90
MIRAGE® 3D INDUCTION.....	306-307	REHERMALIZER RETRO.....	308-309
MIRAGE® INDUCTION WARMER.....	293	REHERMALIZERS.....	306-313
MIRAMAR®.....	408-411	RICE COOKER.....	294
MIRAMAR® DISPLAY COOKWARE.....	406-409	RING.....	167
MIXERS.....	302, 303	RING STOP DROP.....	500
MIXING PADDLE.....	124	ROAST PAN.....	88
MOULDS "FLEXIPAN".....	175-181	ROLLING PIN.....	158-159
MULTIMETAL.....	50, 77	SALAD BOWL.....	439
NAPKIN HOLDER.....	419, 483, 515	SALAD CUTTER.....	132
NAPKIN HOLDER. CUBIC.....	419	SALT MILL.....	481
NATURAL BAMBOO & WOOD.....	468, 469	SANITARY GEL LUBRICANT.....	139, 303
NON SLIP SERVING TRAY.....	482, 501	SAUCE PAN ALUMINIUM.....	59
NON-SMOKING SING.....	481	SAUCE PAN COOL • LINE.....	55
NON-STICK SILICONE MAT.....	95	SAUCE PAN INOX-PRO ST/STEEL.....	49-50
NUMBER CARD HOLDER.....	481	SAUCE POT ALUMINIUM.....	58
NUT CRACKER.....	449	SAUCE POT COOL • LINE.....	55
OIL POURER.....	124	SAUCE POT ST/STEEL INOX-PRO.....	48
ONION CUTTER.....	133	SAUTÉ PAN ALUMINIUM.....	59
OVAL MOULD.....	165, 168	SAUTÉ PAN INOX-PRO.....	50
OVAL SERVING DISH.....	345, 349-350, 355, 365, 370, 438, 461	SCALE.....	147
OVAL SERVING TRAY.....	482	SCOOP.....	152, 155, 497
OVEN MITT.....	149	SCRAPER.....	113-114
OVENS.....	29-31, 294	SERVER.....	507
PAELLA PAN ALUMINIUM.....	73	SERVER, POLICARBONATE.....	509
PAELLA PAN INOX-PRO ST/STEEL.....	48	SERVING PADDLE.....	342, 465
PAN BAND.....	198	SERVING BOARD.....	342
PASTA COLANDER.....	52	SERVING TOOLS.....	440-449
PASTRY BAGS.....	170	SERVING TRAY.....	388, 389, 501
PASTRY MOULDS.....	163-165, 167-169, 177-189	SERVING TRAY. CUBIC.....	416-418, 420
PASTRY TORCH.....	160	SHAKER.....	496
PEPPER MILL.....	481	SHELIVING.....	268-277
PERFORATED BOTTOMS GASTRONORM.....	195, 196, 203, 205, 254	SIEVES.....	161
PIZZA BAGS.....	214, 215	SILICONE MOULDS.....	182-185
PIZZA BAKING SHEETS.....	93	SILICONE MOULDS 600 X 400.....	184-185
PIZZA MOULD.....	93	SKEVER.....	28, 482
PIZZA PAN.....	93, 94	SKEWER SERVING SUPPORT. CUBIC.....	418
PIZZA PEEL.....	95	SKEWER SUPPORT. CUBIC.....	419
PIZZA WHEEL.....	113	SKIMMER.....	99, 100, 441-444

ITEM	PAGE	ITEM	PAGE
SNACK BOWL SET.....	344, 352, 360, 380, 382, 479	TROLLEY (ALUMINIUM SERVING).....	245
SOUP KETTLE.....	314	TROLLEY (DEFROST WITH RAIL).....	254
SOUP TOUREEN.....	439	TROLLEY (DISASSEMBLED SERVING TROLLEY).....	248
SPATULA.....	99, 112, 113, 157, 441-446	TROLLEY (DISASSEMBLED WITH RAIL).....	251-253
SPECIAL TROELLYS.....	257-261	TROLLEY (GUERIDON).....	426
SPOODLE®.....	102-103, 105	TROLLEY (INOX SERVING).....	246-249, 255
SPOON.....	100, 101, 103-105, 157, 369, 380, 441-446	TROLLEY (PLASTIC).....	244, 245, 260, 261
SPOONS.....	441-443, 444-446	TROLLEY (RAIL).....	250-257
SQUEEZE DISHER.....	104	TROLLEY (STACKABLE).....	251, 252
SQUEEZE DISPENSER.....	122, 123	TROLLEY (WOODEN).....	425-427
ST/STEEL SELF-SERVICE TRAY.....	222	TROLLEY FOR DISHWASER RACKS.....	259-260
STAINLESS STEEL MINIATURES.....	454-456	TROLLEY FOR HEAVY LOADS.....	259
STAINLESS STEEL PLATE COVERS.....	485	TROLLEY WITH WORKING TOP.....	258
STAND FOR CHINESE COLANDER OR FUNN.....	116	TUBE.....	171-174
STAND FOR CUTTING BOARDS.....	202	T-VERSION.....	228-233
STAND FOR GN CONTAINERS.....	198, 379	UNIVERSAL STOPPER.....	500
STAND FOR GN LIDS.....	202	VEGETABLE SCRAPER.....	140
STEAM POT INOX-PRO.....	52	VEGETABLE SIEVE.....	118
STOCK POT ALUMINIUM.....	56-59	VERSATIL MACHINE.....	135
STOCK POT COOL • LINE.....	52	VERSATILE MANUAL PROCESSOR.....	137
STOCK POT INOX-PRO.....	48, 44	VINYL RACK COVER.....	261
STOCK POT WITH TAP.....	52	VIOLET COLLECTION.....	208
STONE.....	354	WALL-MOUNTED COWKSCREW.....	502
SUGAR BOWL.....	503	WARMERS.....	313, 314
SUPER PAN® 3.....	201	WATER PITCHER.....	508-509
SUPER PAN® SUPER SHAPES.....	200-201	WEDGER.....	134
SUPPORT FOR CUTLERY DISPENSER.....	223, 237, 257, 420, 427	WHISK.....	156
SUPPORT FOR PASTRY BAGS.....	170	WHITE WOOD SERVING TRAY.....	371
TABLE CADDY.....	480	WINE BUCKETS.....	491, 492, 494, 495
TABLE CRUMBER.....	483	WINE COMPLEMENTS.....	500
TABLE NUMBER.....	481	WINE COOLER.....	495
TABLE SING "RESERVED".....	481	WIRE SKIMMER.....	100
TABLE-TIDY.....	483	WOK (ST/STEEL).....	72
TEA POT.....	503, 504-505	WOK BLAC SERIES.....	79
TEA POT WITH FILTER.....	504	WOK MULTIMETAL.....	77
TEA&SUGAR BAGS DISPENSER. CUBIC.....	419	WOK STEEL.....	83
TEAR MOULD.....	168	WOK STEEL PRO.....	81
TEMPLATES.....	41, 410-411	WOOD SERVING BOARDS.....	462
TERRACOTA.....	352-353	WOODEN BOX.....	387
THERMOMETER.....	147-148		
THREE LEVELS STAND. CUBIC.....	417		
TIN PLATES DISPLAY.....	464-465		
TOASTER.....	296-300		
TOMATOES SLICER.....	137		
TONG.....	35, 95, 107-110, 168, 446, 447-449, 469, 497		
TONG. BUTCHER'S.....	449		
TONG. CAKE.....	448		
TONG. UTILITY.....	108-109, 447		
TONGS, SERVING.....	447		
TRAY.....	89-92, 220, 222-223, 335, 340-341, 343-344, 350-355, 360, 362, 364-367, 371-372, 380, 382		
TRAY (FAST-FOOD).....	222		
TRAY (GASTRONORM).....	89, 367, 465		
TRAY (NON-STICK ALUMINIUM).....	89, 91		
TRAY (PASTRY).....	90-92, 351		
TRAYS, FIBERGLASS.....	222		
TRIANGLE CAKE MOULD.....	169		
TRIBUTE.....	45, 69		

# Index

Índice

Index

ARTÍCULO	PÁGINA
ABRELATAS INDUSTRIAL .....	138
ALCUZA.....	124
ALFOMBRA DE BAR PAR ESCURRIR COPAS.....	498
ALFOMBRAS.....	149
ANILLO ANTI-GOTEO.....	500
ANTIMICROBIAL .....	102, 103
APLASTACARNES.....	119
ARAÑA .....	100
ARMARIO CALIENTE.....	321
ARO .....	167
ASADOR GRILL.....	79, 80
AZUCARERO .....	503
BALANZA.....	147
BAMBÚ NATURAL & MADERA.....	468, 469
BANDA SELLADORA SILICONA.....	198
BANDEJA..... 89-92, 220, 222-223, 335, 340-341, 343-344, 350-355, 360, 362, 364-367, 371-372, 380, 382	
BANDEJA ALUMINIO ANTIADHERENTE .....	89, 91
BANDEJA AUTO-SERVICE ACERO INOX.....	222
BANDEJA FAST-FOOD .....	222
BANDEJA GASTRONORM.....	89, 367, 465
BANDEJA ISOTÉRMICA .....	256
BANDEJA OVAL .....	482
BANDEJA PASTELERÍA.....	90-92, 351
BANDEJA PORTACUBIERTOS .....	223
BANDEJA PRESENTACIÓN ...335, 340, 341, 345, 351, 371, 380, 395, 420, 467	
BANDEJA SERVICIO .....	388, 389, 501
BANDEJAS ANTI-DESIZANTES .....	482, 501
BANDEJAS FIBRA DE VIDRIO .....	222
BANDEJAS PARA PIZZA.....	93
BANDEJAS. CUBIC.....	416-418, 420
BAÑO MARÍA.....	50, 313, 318, 433
BAR KEEP®.....	498
BARRA DE NOTAS.....	124
BASE PIZZA .....	93, 94
BATERÍA BRONCE.....	400
BATERIA COLOR .....	55
BATERÍA MIRAMAR® .....	406-409
BATERIA PRESENTACIÓN.....	408-411
BATIDOR .....	156
BATIDORA SOBRE MESA.....	302
BATIDORAS PLANETARIAS .....	302, 303
BLACK FIRST .....	80
BLACK PRO .....	78-79
BLACK SERIES.....	60
BOL.. 221, 334, 337-339, 344-346, 348, 353-354, 356, 359-360, 362-363, 365-370, 380, 395, 437	
BOL DOBLE PARED .....	221, 437
BOL ESTRIDADO INCLINADO .....	437
BOLSAS DE CATERING.....	216, 217
BOLSAS PARA PIZZAS .....	214, 215
BOQUILLA.....	171-174
BOQUILLA POLICARBONATO.....	174
BOTELLA BAR .....	498, 500
BRASA .....	27-37
BUFFET CUBIC. CARRO BUFFET .....	425-427
BUFFET CUBIC. CUBOS Y ESTANTES.....	421

# español

ARTÍCULO	PÁGINA
BUFFET CUBIC. MUEBLE EXPOSITOR.....	419, 422, 423
CACEROLA ALUMINIO.....	58
CACEROLA COOL • LINE.....	55
CACEROLA INOX-PRO .....	48
CACILLO.....	98, 369, 441-445
CADDY DE MESA .....	480
CAFETERA.....	502-505
CAJA CONDIMENTOS.....	499
CAJA DE MADERA .....	387
CAJA GN BAMBU .....	391
CAJA PPE.....	213
CALDERO.....	154
CALENTADOR DE PLATOS .....	257, 321
CALENTADOR INDUCCIÓN MIRAGE .....	293
CALENTADORES .....	313, 314
CARRO BEBIDAS .....	489, 490
CARRO CON GUIAS.....	250-257
CARRO CON GUIAS, DESMONTABLE .....	251-253
CARRO CON GUIAS, ENCASTRABLE .....	251, 252
CARRO CON SUPERFICIE DE TRABAJO.....	258
CARRO DE MADERA.....	425-427
CARRO DE PLÁSTICO .....	244, 245, 260, 261
CARRO DE SERVICIO DESMONTABLE .....	248
CARRO DE SERVICIO EN ALUMINIO .....	245
CARRO DE SERVICIO INOXIDABLE.....	246-249, 255
CARRO DESCONGELACIÓN.....	254
CARRO DESEMBARACE .....	245, 246
CARRO DOBLE PARA BANDEJAS FAST-FOOD.....	256
CARRO GASTRONORM DESCONGELACIÓN.....	254
CARRO GUERIDON .....	426
CARRO PARA CARGAS PESADAS.....	259
CARRO PARA CESTAS .....	259-260
CARRO PARA PLATOS AJUSTABLE .....	261
CARRO PORTA CUBETAS GASTRONORM .....	250-252, 258
CARRO PORTACUBIERTOS.....	258, 427
CARROS ESPECIALES .....	257-261
CASCANUECES.....	449
CAYENNE®.....	312-313
CAZO ALUMINIO .....	59
CAZO BOMBEADO .....	46, 50, 59
CAZO COOL • LINE .....	55
CAZO INOX-PRO .....	49-50
CAZO TIPO FRANCÉS .....	49
CAZOS DE MEDIDAS.....	145
CAZUELA ALUMINIO FUNDICIÓN .....	60
CAZUELA BLACK SERIES.....	60
CEDAZO .....	161
CENICERO .....	383, 483
CENTURY.....	58, 59
CEPILLO METÁLICO .....	124
CESTA GRANDES BANDEJAS .....	240
CESTA METAL .....	471
CESTA PAN.....	473-477
CESTA PARA BANDEJAS ISOTÉRMICAS .....	240
CESTA PARA CUBIERTOS .....	236, 237, 477
CESTA REJADA .....	390
CESTA UNIVERSAL .....	236
CESTAS ABIERTAS.....	230-233

# español

ARTÍCULO	PÁGINA
CESTAS CERRADAS.....	234, 235
CESTAS PARA PLATOS.....	238-240
CESTAS POLIPROPILENO .....	474-477
CESTILLO PARA CUBIERTOS.....	237
CHAFING , ACCESORIOS .....	429, 432, 434
CHAFING DISH .....	428-431
CHAFING DISHEES ECONOMICOS.....	431
CHAFING DISHES INTRIGUE.....	429
CHAMPAÑERA .....	491, 492, 494, 495
CHAMPAÑERA, COMPLEMENTOS.....	500
CHIMENEA .....	28
CINTA PVC PARA MOUSSE .....	168
CLIP DE IDENTIFICACIÓN.....	228, 234, 235, 239, 240
COCTEL .....	496, 497
COCTELERA.....	496
COLADOR.....	115-116
COLADOR CHINO.....	116
COLADOR GUSANILLO.....	497
COLAPASTAS .....	52
COLECTIVIDADES .....	220-223
CONJUNTOS COMPLETOS DE ESTANTERIAS .....	268-277
CONJUNTOS. CUBIC .....	415-417
COOL • LINE.....	55, 71
COPA HELADO.....	153
CORTADOR / DESCORAZONADOR MANZANAS.....	138
CORTADOR DE CEBOLLAS .....	133
CORTADOR DE LECHUGA.....	132
CORTADOR DE PATATAS FRITAS.....	131
CORTADOR EN CUBOS .....	135
CORTADOR SECCIONADOR.....	134
CORTADOR TOMATES.....	137
CORTADORA ELÉCTRICA DE FIAMBRES .....	303
CORTADOR-REBANADOR.....	129, 130
CORTAHUEVOS.....	138
CORTAPASTAS .....	158, 166-168
CRÊPERA.....	294
CUBERTERO PARA CARRO SERVICIO .....	246
CUBETA GASTRONORM SIN BPA.....	204, 205
CUBETAS HELADERÍA .....	153
CUBITERA DE PLÁSTICO.....	494-495
CUBO CHAMPÁN .....	491, 492, 494, 495
CUBO CON BASE.....	146
CUBO HIELO.....	493
CUCHARA.....	100, 101, 103-105, 157, 369, 380, 441-446
CUCHARA BATIDORA .....	497
CUCHARA MEDIDORA .....	144, 145
CUCHARA SERVICIO.....	441-443, 444-446
CUCHILLA/RODILLO DE RECAMBIO.....	138
CUCHILLO .....	441, 443, 446
CUSCUSERA.....	51
DISPENSADOR A PRESIÓN .....	122, 123
DISPENSADOR BOLSAS TE Y AZÚCAR. CUBIC.....	419
DISPENSADOR CON CONTROL DE PORCIONES .....	162
DISPENSADOR DE CEREALES.....	435
DISPENSADOR DE ZUMOS.....	435
DISPENSADOR LECHE .....	434, 435
DISPENSADOR Y FUNDAS DESECHABLES .....	250
DISPENSADORES.....	162, 434, 435

# Index

Índice

Index

ARTÍCULO	PÁGINA
DOSIFICADOR LICOR.....	497
ELEGANCE.....	355
ELEMENTO ELÉCTRICO CHAFING DISH.....	432
EMBUDO .....	118, 162
EMBUDO DOSIFICADOR.....	162
ENFRIADOR BOTELLAS BUFFET. CUBIC.....	418
ENFRIADOR ISOTÉRMICO.....	493
ENSALADERA ACRÍLICA.....	439
ESCAMADOR .....	124
ESCURRIDERA .....	117
ESPÁTULA .....	99, 112, 113, 157, 441-446
ESPÁTULA PARA UNTAR .....	114
ESPECIEROS.....	123
ESPUMADERA .....	99, 100, 441-444
ESTACION BUFFET TRINCHANTE .....	317
ESTANTERÍAS.....	268-277
EXPOSITOR BOLLERIA.....	396, 397
EXPOSITOR BUFFET .....	339, 340, 395
EXPOSITOR DE TARTAS.....	161
EXPOSITOR GASTRONORM .....	198, 223, 379, 417
EXPOSITOR TRES NIVELES. CUBIC .....	417
EXPOSITORES.....	386, 391-393
EXPRIME LIMONES.....	497
FLANERO .....	169
FLAP IDENTIFICACIÓN.....	227
FLAP-RACK® .....	227, 228
FONDOS PERFORADOS GASTRONORM .....	195, 196, 203, 205, 254
FREIDORA.....	295
FUEL PARA CHAFING DISH.....	432
FUENTE. 155, 201, 318, 345, 349-350, 355, 365, 370, 409, 429, 438, 461	
FUENTE FONDUE CHOCOLATE.....	318
FUENTE HONDA CÓNICA .....	155
FUENTE OVAL.....	345, 349-350, 355, 365, 370, 438, 461
FUNDA PROTECTORA DE VINILO.....	261
GANCHO .....	118
GASTRONORM ACERO ESMALTADO .....	399
GASTRONORM FONDO DIFUSOR .....	189, 199, 401
GASTRONORM INOXIDABLE .....	194-197
GASTRONORM MELAMINA.....	374-378
GASTRONORM POLICARBONATO .....	202-203
GASTRONORM POLIPROPILENO .....	206-207
GASTRONORM VIOLET .....	208
GEL LUBRICANTE SANITARIO .....	139, 303
GN PASTRY PAN .....	154
GRILL DE CONTACTO .....	301
GUANTES PROTECCIÓN .....	149
HELADERÍA .....	150-151, 322-327
HERVIDOR DE ARROZ.....	294
HORNOS .....	29-31, 294
HORNOS DE BRASA.....	29-31
INDUCCIÓN 3-D MIRAGE.....	306-307
INOX-PRO.....	46-53
INSERTOS.....	289, 293
JARRA .....	507
JARRA AGUA .....	508-509
JARRA DE MEDIDAS.....	146
JARRA MEDIDORA .....	146
JARRA PARA INFUSIONES .....	505

ARTÍCULO	PÁGINA
JARRA POLICARBONATO .....	509
JARRA TERMO .....	507
LÁMPARAS MANTENEDORAS.....	315-317
LECHERA .....	502-504
LIBRADOR .....	152, 155, 497
LIDSAVER® .....	510-515
LLAUNAS PRESENTACIÓN .....	464-465
MANDOLINAS .....	139
MANGAS PASTELERAS .....	170
MANOPLA.....	149
MANTA ENFRIADORA.....	495
MANTECADORA.....	326
MANTEL ANTIDESLIZANTE PARA BANDEJA.....	501
MANTELES INDIVIDUALES.....	478
MARCADOR DE TARTAS.....	160
MARCADORES TIZA.....	451
MARCOS PARA BANDEJAS.....	90
MEDITERRANEAN.....	356
MELAMINA PRESENTACIÓN .....	334-383
MELAMINA SLIM.....	376-377
MESA DE CORTE .....	140-142
MICRO-ONDAS .....	294
MINIATURAS ACERO ESMALTADO.....	458
MINIATURAS ALUMINIO FUNDICIÓN .....	459
MINIATURAS HIERRO FUNDIDO.....	460-461
MINIATURAS INOXIDABLE.....	454-456
MINIATURAS MELAMINA.....	380-382
MIRAGE®.....	292-293, 306-309
MIRAMAR®.....	408-411
MOCHILA DE REPARTO.....	218-219
MOLDE CAKE.....	163-165, 169, 182
MOLDE FORMA CORAZÓN .....	168
MOLDE FORMA LÁGRIMA.....	168
MOLDE HEXAGONAL.....	168
MOLDE HUEVO.....	119
MOLDE MEDIA CAÑA .....	169
MOLDE NIDO .....	100
MOLDE OVAL .....	165, 168
MOLDE PARA PIZZA.....	93
MOLDE SEMIESFÉRICO .....	155
MOLDES “FLEXIPAN”.....	175-181
MOLDES DE SILICONA .....	182-185
MOLDES PASTELERÍA .....	163-165, 167-169, 177-189
MOLDES SILICONA 600 X 400.....	184-185
MOLINILLO PIMIENTA.....	481
MOLINILLO SAL .....	481
MULTIMETAL.....	50, 77
NÚMERO MESA .....	481
OLLA ALUMINIO .....	56-59
OLLA CON GRIFO .....	52
OLLA COOL • LINE.....	52
OLLA ELÉCTRICA.....	314
OLLA INOX-PRO.....	48, 44
PAELLERA ACERO ESMALTADO .....	84
PAELLERA ALUMINIO .....	73
PAELLERA INOX-PRO.....	48
PAELLERA VALENCIANA.....	84
PAELLERO ESMALTADO GAS.....	85

ARTÍCULO	PÁGINA
RECIPIENTE PARA SALSAS .....	145, 337, 380, 463, 477, 479, 480
RECOGEMIGAS .....	483
RECOGEVERDURAS.....	140
REJILLAS GN.....	92
REJILLAS PASTELERÍA.....	88
RELOJ DE COCINA DIGITAL.....	147
REMO .....	124
RETERMALIZADOR .....	306-313
RETERMALIZADOR RETRO .....	308-309
RETERMALIZADORES / CALENTADORES ALIMENTOS.....	310-314
RODILLO .....	158-159
RULETA CORTAPIZZAS .....	113
RUSTIDERA .....	88
SACACORCHOS.....	500, 502
SACACORCHOS DE PARED.....	502
SALSERA .....	479
SALSERA BORDE ONDULADO.....	479
SARTÉN “LIONESA” .....	83
SARTÉN ACERO INOXIDABLE.....	70-72
SARTÉN ALUMINIO .....	73-76
SARTÉN ALUMINIO FUNDICIÓN .....	78-80
SARTÉN BLACK PRO.....	78
SARTÉN CRÊPES.....	79, 80
SARTÉN HONDA ESMALTADA CON ASAS.....	84
SARTÉN IDEA.....	72
SARTÉN MULTIMETAL .....	69
SARTÉN PARA BLINIS.....	76
SARTÉN STEEL PRO.....	81
SARTENES .....	62-83, 408
SARTENES COOL • LINE.....	71
SAUTEX ALUMINIO .....	59
SAUTEX INOX-PRO .....	50
SERVILLETTERO.....	419, 483, 515
SERVILLETTERO. CUBIC.....	419
SOLUCIONES DE DISPENSADO .....	510-515
SOPERA .....	439
SOPLETE COCINA.....	160
SOPORTE MÁRMOL EXHIBICIÓN .....	373
SOPORTE PARA BANDEJAS DE GRAN TAMAÑO.....	482
SOPORTE PARA CHINO O EMBUDO .....	116
SOPORTE PARA CUBO CHAMPÁN.....	495
SOPORTE PARA MANGAS PASTELERAS.....	170
SOPORTE PARA NÚMEROS.....	481
SOPORTE PARA PINCHOS. CUBIC.....	419
SOPORTE PARA TABLAS DE CORTE.....	202
SOPORTE PRESENTACIÓN MADERA BLANCA.....	371
SOPORTE PRESENTACIÓN PIZARRA-MÁRMOL.....	373
SOPORTE TAPAS GN.....	202
SPOODLE® .....	102-103, 105
STONE.....	354
SUPER PAN® 3 .....	201
SUPER PAN® SUPER SHAPES .....	200-201
TABLA DE CORTE.....	140-142
TABLA DE CORTE VIOLET.....	142
TABLA PRESENTACIÓN .....	342
TABLAS DE MADERA.....	462
TAPA BATERIA .....	33, 49, 399
TAPA GN .....	33, 197, 203, 205, 207-208

ARTÍCULO	PÁGINA
TAPA GRILLBOX.....	28
TAPA HERMÉTICA GN.....	33, 197
TAPA HERMÉTICA GN EASY OPEN.....	197
TAPA INOX PARA PLATOS.....	485
TAPA INOX-PRO.....	49
TAPA PARA CESTA.....	236
TAPA PLATOS .....	485
TAPA PLATOS PLÁSTICO .....	485
TAPA POLINORM® .....	197, 203, 205, 207
TAPA TAZA DESAYUNO.....	221
TAPAS GN TRANSPARENTES.....	341, 397
TAPAS PARA PLATOS.....	485
TAPETE DE SILICONA.....	95
TAPÓN CHAMPÁN .....	500
TAPÓN UNIVERSAL .....	500
TAZA.....	221, 369
TAZA MEDIDORA.....	145, 146
TENEDOR .....	101, 103, 441-443, 446
TERMO CON DOSIFICADOR.....	506
TERMÓMETRO .....	147-148
TERRACOTA.....	352-353
TETERA.....	503, 504-505
TETERA CON FILTRO.....	504
TOSTADORA .....	296-300
TRIBUTE.....	45, 69
TRÍPODE PAELLERO.....	85
T-VERSION .....	228-233
UTENSILIOS DE SERVICIO .....	440-449
VAPORERA INOX-PRO .....	52
VASO .....	221, 356, 457, 496
VERSATIL MACHINE .....	135
VIOLET COLLECTION .....	208
VITRINAS DE VIDREO .....	321
VITRINAS PRESENTACIÓN .....	402
WOK ACERO .....	83
WOK BLACK SERIES.....	79
WOK INOX.....	72
WOK MULTIMETAL .....	77
WOK STEEL PRO .....	81

# Index

Índice  
Index

ARTICLE	PAGE
ANTIMICROBIEN.....	102, 103
APLATISSEUR.....	119
APPAREILS ET DE MAINTIEN EN TEMP. ....	313, 314
APPAREILS MANUELS DE TRANSFORMATION DES ALIMENTS .	129-139
ARAIGNÉE .....	100
ARDOISES PRÉSENTATION.....	466-467
ARMOIRE CHAUD.....	321
ASSIETTES .....	221, 334-336, 338, 344-350, 353-357, 360-361, 368, 370
ASSIETTES, COULEUR .....	336, 357
BAC À ALIMENTS ..	155, 201, 318, 345, 349-350, 355, 365, 370, 409, 429, 438, 461
BAC GASTRONORME SANS BPA.....	204, 205
BAC GN ACIER ÉMAILLÉ .....	400
BAIN-MARIE .....	50, 313, 318, 433
BALANCE.....	147
BAMBOU NATUREL & BOIS .....	468, 469
BANDE À SILICONE .....	198
BAR KEEP®.....	498
BARRE INTERMÉDIAIRE.....	192, 195
BARRE PORTE-BONS .....	124
BASSINE.....	154
BASSINE PÂTISSIÈRE .....	155
BATTERIE À COULEURS.....	55
BATTERIE BRONZE .....	399
BATTERIE DE CUISINE / PRÉSENTATION .....	408-411
BLACK FIRST .....	80
BLACK PRO .....	78-79
BLACK SERIES .....	60
BOIS BLANVC, PLATEAU .....	371
BOÎTE À CONDIMENT.....	499
BOÎTE EN BOIS .....	387
BOÎTE PPE .....	213
BOL..	221, 334, 337-339, 344-346, 348, 353-354, 356, 359-360, 362-363, 365-370, 380, 395, 437
BOL POUR SNACKS.....	344, 352, 360, 380, 382, 479
BOLS DE SERVICE ISOTHERMES À DOUBLE PAROI.....	221, 437
BOLS NID D'ABEILLES À PAROI INCLINÉE .....	437
BOUCHON À CHAMPAGNE.....	500
BOUCHON UNIVERSEL .....	500
BOUTEILLE DE BAR .....	498, 500
BRAISE .....	27-37
BROCHETTE.....	28, 482
BROSSE METALLIQUE .....	124
BRÛLER ÉMAILLÉ.....	85
BUFFET CUBIC. CHARIOT BUFFET.....	425-427
BUFFET CUBIC. CUBES ET TABLETTES .....	421
BUFFET CUBIC. MEUBLE PRÉSENTOIR .....	419, 422, 423
CADDY DE TABLE .....	480
CAFETIÈRE .....	502-505
CANNETTE ISOLANTE .....	507
CARAMÉLISER .....	160
CASSE-NOIX.....	449
CASSE-PATTES.....	449
CASSEROLE ALUMINIUM.....	59
CASSEROLE BOMBÉE .....	46, 50, 59
CASSEROLE COOL • LINE .....	55
CASSEROLE FORME FRANÇAISE.....	49
CASSEROLE INOX-PRO.....	49-50

# français

ARTICLE	PAGE
CASSEROLÉS DOSEUR.....	145
CAYENNE®.....	312-313
CAYENNE® RÉCHAUDS ET APPAREILS DE REMISE EN TEMPÉRATURE ..	310-314
CENDRIER .....	383, 483
CENTURY.....	58, 59
CERCLE .....	167
CHAFERS .....	428-431
CHAFERS INTRIGUE .....	429
CHAFERS, ACCESSOIRES POUR .....	429, 432, 434
CHAFING DISH ECONOMIQUE.....	431
CHARIOT À CHARGES LOURDES.....	259
CHARIOT À DÉGIVRAGE .....	254
CHARIOT À GLISSIÈRES .....	250-257
CHARIOT À GLISSIÈRES, DÉMONTABLE.....	251-253
CHARIOT À GLISSIÈRES, EMBOÎTABLE.....	251, 252
CHARIOT À PLASTIQUE .....	244, 245, 260, 261
CHARIOT AJUSTABLE .....	261
CHARIOT AVEC PLAN DE TREVALL.....	258
CHARIOT DE DÉBARASSAGE.....	245, 246
CHARIOT DE SERVICE DÉMONTABLE .....	248
CHARIOT DE SERVICE EN ALUMINIUM.....	245
CHARIOT DOUBLE POUR PLATEAUX FAST-FOOD.....	256
CHARIOT EN BOIS .....	425-427
CHARIOT GUERIDON.....	426
CHARIOT POUR PANIERS À VAISSELLE .....	259-260
CHARIOT TRANSPORT BAC GN .....	250-252, 258
CHARIOTS DE SERVICE INOXYDABLE.....	246-249, 255
CHARIOTS SPÉCIAUX .....	257-261
CHEMINÉE.....	28
CHINOIS À GAZE.....	116
CLIP D'IDENTIFICATION.....	228, 234, 235, 239, 240
COCKTAIL .....	496, 497
COCOTTE .....	60
COCOTTE BLACK SERIES.....	60
COCOTTES FONTE ALUMINIUM .....	459
COLLECTIVITÉS.....	220-223
CONTENEUR POUR SERVIETTES.....	419, 483, 515
COOL • LINE.....	55, 71
CORBEILLE PAIN .....	473-477
CORBEILLES POLYPROPYLENE.....	474-477
CORPS DE CHAUFFE POUR CHAFING DISH.....	432
COUPE À GLACE .....	153
COUPE EN CUBES .....	135
COUPE FRITES.....	131
COUPE TOMATES.....	137
COUPE-OEUF.....	138
COUPE-ONIONS .....	133
COUPE-SALADE .....	132
COUP-FRUIT ET LÉGUMES.....	133
COUSCOUSSIER.....	51
COUTEAU .....	441, 443, 446
COUTEAU / ROULEAU (PIÈCE DE RECHNGE).....	138
COUTEAU À BEURRE .....	114
COUVER-ASSIETTES EN PLASTIQUE .....	485
COUVERCLE BATTERIE .....	33, 49, 399
COUVERCLE GN.....	33, 197, 203, 205, 207-208
COUVERCLE GRILLBOX.....	28

# français

ARTICLE	PAGE
COUVERCLE HERMET .....	33, 197
COUVERCLE HERMET EASY OPEN.....	197
COUVERCLE INOX-PRO .....	49
COUVERCLE POLINORM®.....	197, 203, 205, 207
COUVERCLE POUR COUPELLE DESSERT.....	221
COUVERCLE POUR PANIER .....	236
COUVERCLES À ASSIETTE .....	485
COUVERCLES À ASSIETTE .....	485
COUVERCLES GN TRANSPARENTS.....	341, 397
COUVRE-ASSIETTES INOX.....	485
CREMIÈRE.....	502-504
CRÉPIÈRE.....	294
CROCHET .....	118
CUILLÈRE.....	100, 101, 103-105, 157, 369, 380, 441-446
CUILLÈRE À COCKTAIL.....	497
CUILLÈRE À GLACE .....	152
CUILLÈRES À MESURER.....	144, 145
CUILLÈRES À SERVIR .....	441-443, 444-446
CUISEUR À RIZ.....	294
CUIT-PÂTES.....	52
CUIT-VAPEUR INOX-PRO.....	52
DEMI-SPÉRIQUE.....	155
DISTRIBUER À JUS .....	435
DISTRIBUTEUR À LAIT.....	434, 435
DISTRIBUTEUR À PRESSION.....	122, 123
DISTRIBUTEUR CONTRÔLE DE LA PARTIE .....	162
DISTRIBUTEUR DE CÉRÉALES .....	435
DISTRIBUTEUR DES SAQUETTES THÉ & SUCRE. CUBIC .....	419
DISTRIBUTEUR ET HOUSSES JETABLES .....	250
DISTRIBUTEUR SERVIETTES. CUBIC .....	419
DISTRIBUTEURS.....	162, 434, 435
DIVISEUR .....	134
DOSEUR À PRESSER.....	104
DOUILLE .....	171-174
ECAILEUR .....	124
ECUMOIRE .....	99, 100, 441-444
EGOUTTOIRS POUR BACS GASTRONORME.....	195, 196, 203, 205, 254
ELEGANCE.....	355
ENCASTRÉE.....	289, 293
ENTONNOIR.....	118, 162
ENTONNOIR DOSEUR.....	162
EPINGLE PORTE-TICKETS.....	482
ETAGÈRES .....	268-277
FAITOUT ALUMINIUM .....	58
FAITOUT COOL • LINE.....	55
FAITOUT INOX-PRO .....	48
FLAP IDENTIFICATION .....	227
FLAP-RACK®.....	227, 228
FONTAIN À CHOCOLAT.....	318
FOUET.....	156
FOUR À BRAISE .....	29-31
FOUR À MICRO-ONDES.....	294
FOURCHETTE .....	101, 103, 441-443, 446
FOURS.....	29-31, 294
FRITEUSE .....	295
FUEL POR CHAFING DISH.....	432
GABARITS.....	41, 410-411
GANT À FOUR.....	149

# Index

Índice  
Index

ARTICLE	PAGE
GANTS.....	149
GARTRONORME POUR CHARIOT DÉGIVRAGE .....	254
GASTRONORM INOXYDABLE .....	194-197
GASTRONORME (MELAMINE) .....	374-378
GASTRONORME (POLYCARBONATE).....	202-203
GASTRONORME (POLYPROPYLENE).....	206-207
GASTRONORME AVEC FOND THERMO-DIFFUSEUR .....	189, 199, 401
GASTRONORME VIOLET .....	208
GEL LUBRIFIANT SANITAIRE.....	139, 303
GLACES.....	150-151, 322-327
GN PASTRY PAN .....	154
GOUTIÈRE .....	169
GRILL.....	79, 80
GRILL DE CONTACT .....	301
GRILL PLAT AVEC POIGNÉES.....	79
GRILLE GN.....	92
GRILLE PÂTISSERIE .....	88
HUILIÈRE .....	124
INOX-PRO.....	46-53
KITS PRÉPARÉS DE ÉTEGÈRE.....	268-277
KITS. CUBIC.....	415-417
LAMPE CHAUFFANTE .....	315-317
LIDSAVER®.....	510-515
LOUCHE.....	98, 369, 441-445
MANDOLINES .....	139
MARMITE ALUMINIUM.....	56-59
MARMITE BUFFET.....	314
MARMITE COOL • LINE.....	52
MARMITE INOX-PRO.....	48, 44
MARMITE TRAITÉUR AVEC ROBINET .....	52
MARMITES DE REMISE EN TEMPÉRATURE .....	306-313
MARMITES DE REMISE EN TEMPÉRATURE RÉTRO.....	308-309
MARQUEURS.....	451
MEDITERRANEAN.....	356
MELAMINE POUR PRÉSENTATION .....	334-383
MÉLAMINE SLIM.....	376-377
MÉLANGEURS .....	302, 303
MÉLANGEURS DE COMPTOIR.....	302
MESURE À COCKTAIL.....	497
MINIATURE FONTE ÉMAILLÉE .....	460-461
MINIATURES ACIER ÉMAILLÉ .....	458
MINIATURES ACIER INOXYDABLE .....	454-456
MINIATURES MÉLAMINE .....	380-382
MINUTEUR DE CUISINE.....	147
MIRAGE®.....	292-293, 306-309
MIRAGE® 3D INDUCTION .....	306-307
MIRAGE® INDUCTION WARMER .....	293
MIRAMAR® .....	408-411
MIRAMAR® BATTERIE DE CUISINE / PRÉSENTATION .....	406-409
MOULE À CAKE .....	163-165, 169, 182
MOULE À FLAN .....	169
MOULE À FLAN ÉVASSÉ .....	479
MOULE À NID.....	100
MOULE À OEUF.....	119
MOULE À PIZZA .....	93
MOULE COEUR.....	168
MOULE HEXAGONE.....	168
MOULE LARME .....	168



ARTICLE	PAGE
MOULE OVALE.....	165, 168
MOULES "FLEXIPAN".....	175-181
MOULES À SILICONE 600 X 400.....	184-185
MOULES DE SILICONE.....	182-185
MOULES PÂTISSERIE.....	163-165, 167-169, 177-189
MOULIN À LÉGUMES.....	118
MOULINS À POIVRE.....	481
MOULINS À SEL.....	481
MULTIMÉTAL.....	50, 77
NUMÉRO DE TABLE.....	481
OICHET À EAU.....	508-509
OUVRE-BOÎTES.....	138
PALETTE.....	99, 112, 113, 157, 441-446
PALETTE À FISH.....	99, 113
PALETTE FAST-FOOD.....	113
PANIER EN MÉTAL.....	471
PANIER FERMÉES.....	230-233
PANIER OUVERTS.....	234, 235
PANIER POUR ASSITTES.....	238-240
PANIER POUR COUVERTS.....	236, 237, 477
PANIER POUR PLATEAUX.....	240
PANIER POUR PLATEAUX ISOTHERMES.....	240
PANIER UNIVERSEL.....	236
PANIER, MÉTALLIQUE.....	390
PANNEAU INFORMATION.....	450
PARE-HALEINE MOBILES.....	394
PARE-HALEINE MOBILES EN ACRYLIQUE.....	394
PASSOIRE À COCKTAIL.....	497
PASSOIRE À POIGNÉES.....	117
PASSOIRE À QUEUE.....	115-116
PELLE.....	28, 95, 99, 111, 113-114, 144, 342, 442, 444, 465, 497
PELLE À ENFOURNER.....	95
PELLE À FARINE.....	152, 155, 497
PELLE À FRITES.....	111
PELLE À GÂTEAU.....	114, 442, 444
PELLE À LÉGUMES.....	140
PELLE GLAÇON.....	497
PELLE MESURE.....	144
PELLE PRÉSENTATION.....	342, 465
PETIT PANIER POUR LES COUVERTS.....	237
PICHET.....	507
PICHET GRADUÉ.....	146
PICHET POLYCARBONATE.....	509
PIED PORTE-SEAU.....	493
PIED POUR BRÛLEUR.....	85
PINCE.....	35, 95, 107-110, 168, 446, 447-449, 469, 497
PINCE À GÂTEAU.....	448
PINCE À VIANDE.....	449
PINCE BUFFET.....	108-109, 447
PINCE DE SERVICE.....	447
PINCEAU.....	159
PINCES POUR PRÉSENTATION.....	107
PIQUES SUPPORT PRÉSENTATION. CUBIC.....	418
PLANCHE À DÉCOUPER.....	140-142
PLANCHE À DÉCOUPER VIOLET.....	142
PLAQUE "DÉFENSE DE FUMER".....	481
PLAQUE "RÉSERVÉ".....	481
PLAQUE À PÂTISSERIE.....	90-92, 351

ARTICLE	PAGE
PLAQUE À PIZZA.....	93, 94
PLAQUE À RÔTIR.....	88
PLAQUE ALUMINIUM ANTI-ADHESIF.....	89, 91
PLAQUE CHAUFFANTE.....	318
PLAQUE GASTRONORME.....	89, 367, 465
PLAQUE INTERMÉDIAIRE INCLINÉE.....	329
PLAQUE RÉFRIGÉRANTE.....	433
PLAQUES À PIZZA.....	93
PLAQUES INDUCTION.....	284-293
PLAT À PAELLA ACIER ÉMAILLÉ.....	84
PLAT À PAELLA ALUMINIUM.....	73
PLAT À PAELLA EN TÔLE ACIER.....	84
PLAT À PAELLA INOX-PRO.....	48
PLAT OVALE.....	345, 349-350, 355, 365, 370, 438, 461
PLATEAU.....	89-92, 220, 222-223, 335, 340-341, 343-344, 350-355, 360, 362, 364-367, 371-372, 380, 382
PLATEAU DE PRÉSENTATION.....	342
PLATEAU DE SERVICE.....	388, 389, 501
PLATEAU DE SERVICE ANTI-DÉRRAPANT.....	482, 501
PLATEAU FAST-FOOD.....	222
PLATEAU FORME OVALE.....	482
PLATEAU ISOTHERMIC.....	256
PLATEAU MARBRES NOIR.....	373
PLATEAU PRÉSENTATION.....	335, 340, 341, 345, 351, 371, 380, 395, 420, 467
PLATEAU PRÉSENTATION. CUBIC.....	416-418, 420
PLATEAU SELF-SERVICE ACIER INOX.....	222
PLATEAUX EN FIBRE DE VERRE.....	222
PLATEAUX INOX PRÉSENTATION.....	464-465
POCHES PÂTISSIÈRES.....	170
POÊLE "LYONNAISE".....	83
POÊLE À BLINIS.....	76
POÊLE À CRÊPES.....	79, 80
POÊLE ACIER INOXYDABLE.....	70-72
POÊLE ALUMINIUM.....	73-76
POÊLE ALUMINIUM FONTÉ.....	78-80
POÊLE BLACK SERIES.....	78
POÊLE COOL • LINE.....	71
POÊLE HAUTE AVEC ANSES.....	84
POÊLE IDEA.....	72
POÊLE MULTIMÉTAL.....	69
POÊLE PUJADAS 1921.....	81
POÊLES.....	62-83, 408
POLYCARBONATE DOUILLE.....	174
PORTE-BROCHETTES.....	35, 482
PORTE-CARTES.....	484
PORTE-MENU.....	484
POT À INFUSIONS.....	505
POT MESUREUR.....	146
POTEAU.....	450
PRÉSENTOIR.....	386, 391-393
PRÉSENTOIR 3 NIVEAUX. CUBIC.....	417
PRÉSENTOIR BACS GASTRONORME.....	198, 223, 379, 417
PRÉSENTOIR BOLS MÉLAMINE. CUBIC.....	421
PRÉSENTOIR BUFFET.....	339, 340, 395
PRÉSENTOIR DE TARTES.....	161
PRÉSENTOIR GN BAMBOU.....	391
PRÉSENTOIR GRANITE-ARDOISE.....	373

ARTICLE	PAGE
PRESSE CITRON.....	497
PROCESSEUR VERSATILE ET MANUEL.....	137
PROTECTRICE EN VINYLE.....	261
PUJADAS 1921. FONTE ULTRALÉGER INDUCTION.....	81
RACLETTE.....	113-114
RAMASSE-COUVERTS.....	223
RAMASSE-COUVERTS POUR CHARIOT SERVICE.....	246
RAMASSE-MIETTES.....	483
RAMEQUIN.....	145, 337, 380, 463, 477, 479, 480
RÂPE.....	120-121
RECEPTALBE À DÉCHETS.....	483
RÉCHAUD.....	257, 321
RÉCIPIENT À GLACE.....	153
RECTANGLE POUR PLAQUES INOX.....	90
REFRAÎCHISSEUR.....	495
REFRAÎCHISSEUR BOUTEILLES. CUBIC.....	418
REFRAÎCHISSEUR ISOTHERME.....	493
ROBOT MULTIFUNCTION.....	302-303
ROULEAU.....	158-159
ROULETTE À PÂTES.....	158, 166-168
ROULETTE À PIZZA.....	113
RUBAN PÂTISSIER.....	168
SACS À DOS DE LIVRAISON.....	218-219
SACS À PIZZAS.....	214, 215
SACS DE TRAITEUR.....	216, 217
SALADIER.....	439
SAUCIÈRE.....	479
SAUPOUDREUSES.....	123
SAUTEUSE ALUMINIUM.....	59
SAUTEUSE INOX-PRO.....	50
SEAU À CHAMPAGNE.....	491, 492, 494, 495
SEAU À CHAMPAGNE EN PLASTIQUE.....	494-495
SEAU À CHAMPAGNE, COMPLÉMENTS.....	500
SEAU À GLAÇONS.....	493
SEAU AVEC BASE.....	146
SEAUX À VIN.....	491, 492, 494, 495
SÉPARATEUR DE PORTIONS.....	160
SETS DE TABLE.....	478
SHAKER.....	496
SOLUTIONS DE DISTRIBUTION.....	510-515
SOUPIÈRE.....	439
SPATULE GÉANTE.....	124
SPOODLE®.....	102-103, 105
STATIONS POUR BUFFET.....	317
STONE.....	354
STOP GOUTTES.....	500
SUCRIER.....	503
SUPER PAN® 3.....	201
SUPER PAN® SUPER SHAPES.....	200-201
SUPPORT À PIQUES. CUBIC.....	419
SUPPORT DE TABLE POUR SEAUX.....	495
SUPPORT NUMÉRO.....	481
SUPPORT POUR BACS GN.....	258, 427
SUPPORT POUR BACS GN.....	198, 379
SUPPORT POUR COUVERCLES GN.....	202
SUPPORT POUR ENTONNOIR OU CHINOIS.....	116
SUPPORT POUR GRANDS PLATEAUX.....	482
SUPPORT POUR PLANCHES À DÉCOUPER.....	202

ARTICLE	PAGE
SUPPORT POUR POCHE PÂTISSIER.....	170
SUPPORT RAMASSE-COUVERTS.....	223, 237, 257, 420, 427
TABLE À DÉCOUPER.....	140-142
TABLE EN BOIS.....	462
TABLEAUX.....	451
TAMIS.....	161
TAPIS.....	149
TAPIS ANTIDÉRAPANT.....	501
TAPIS DE BAR.....	498
TASSE.....	221, 369
TASSE GRADUÉE.....	145, 146
TCHARIOT BOISSON.....	489, 490
TERRACOTA.....	352-353
THÉIÈRE.....	503, 504-505
THÉIÈRE AVEC FILTRE.....	504
THERMOMÈTRE.....	147-148
TIRE-BOUCHONS.....	500, 502
TIRE-BOUCHONS MUR.....	502
TOASTEUR.....	296-300
TOILE DE CUISSON.....	95
TORCHE À CARAMÉLISER.....	160
TORCHON EN SILICONE.....	149
TRANCHES ET CUBES.....	129, 130
TRANCHEUR ELÉCTRIQUE.....	303
TRIBUTE.....	45, 69
TURBINE À GLACE.....	326
T-VERSION.....	228-233
USTENSILS DE SERVICE.....	440-449
VERRE.....	221, 356, 457, 496
VERSATIL MACHINE.....	135
VERSEUSE À POMPE.....	506
VIDE / COUPE POMMES.....	138
VIOLET COLLECTION.....	208
VITRINES À PÂTISSERIES.....	396, 397
VITRINES EN VERRE.....	321
VITRINES PRÉSENTATION.....	402
WOK ACIER.....	83
WOK BLACK SERIES.....	79
WOK INOX.....	72
WOK MULTIMÉTAL.....	77
WOK STEEL PRO.....	81

# Numerical index

Índice numérico  
Index numérique

REF.	PAG.	REF.	PAG.	REF.	PAG.	REF.	PAG.	REF.	PAG.
1697	260	15105	137	4075503	302	46590	437	47140	104
46599	508	15113	137	4075602	302	4659015	437	47141	104
46622	500	15114	137	4075603	302	4659050	437	47142	104
46789	500	15115	137	4075702	303	4659060	437	47143	104
46790	497	15149	139	4075703	303	46591	437	47144	104
47611	493	15209	137	4075802	303	4659115	437	47145	104
47620	491	15601	133	4075803	303	4659150	437	47146	104
48070	496	15604	133	4075902	303	4659160	437	47150	152
52291	260	1612-06	501	4075903	303	46592	437	47151	152
97181	247	1811	135	40761	302	4659215	437	47152	152
0644N	137	1812	135	40762	302	4659250	437	47153	152
0653	137	1823	135	40763	302	4659260	437	47154	152
0654	137	19196	392	40764	302	46654	145	47155	152
1009-01	228	2200-777	122	40765	303	46655	145	47156	152
1009-02	228	2208-13TT	122	40766	303	46656	145	47157	152
1009-03	228	2212-13TT	122	40767	303	46657	145	47158	152
1009-04	228	2224-13TT	122	40768	303	46658	145	47159	152
1009-05	228	2331-99	498	40769	303	46659	145	47160	152
1009-06	228	26120-13	123	40770	303	46661	145	47161	152
1009-08	228	26240-13	123	40771	303	46665	437	47169	152
1009-19	228	26320-13	123	40772	303	46666	437	47170	152
1009-32	228	2803-18	162	40773	303	46667	437	47171	152
1078-13	485	2808-13	122	40774	303	46671	317	47172	152
1100-13	485	2812-13	122	40775	303	46672	317	47200	152
1200-13	485	2908-13	123	40776	303	46787	497	47274	152
1400	139	2912-13	123	40862	321	46791	496	47275	152
1420-01	501	2960001	28	40863	321	46793	496	47276	152
1474-0606	501	306	134	435	132	46861	429	47277	152
1476-0606	501	308	134	4400N	132	4689760	105	47278	152
15000	130	3100020	404	4408	132	4689815	105	47279	152
15001	130	3100040	404	44572	144	4689830	105	47309	108
15002	130	3100220	404	45749-1	131	4689840	105	47312	108
15005	130	3100240	404	45750-1	131	4689850	105	47316	108
15006	130	3100320	404	45751-1	131	4689860	105	47322	110
15007	130	3100321	404	46009	393	4689960	105	47325	111
15016	130	3100340	404	4600960	393	46905	444	47326	110
15017	130	3100341	404	46070	431	46907	444	47370	104
15050	130	3101015	403	46080	431	46909	444	47371	104
15052	130	3101020	403	46093	434	46926	447	47372	104
15053	130	3101040	403	46094	434	46928	448	47390	104
15054	130	3101120	403	46095	431	46929	449	47391	104
15055	130	3101220	403	46110	318, 432	46936	444	47392	104
15058	130	3101240	403	46115	318, 432	46938	447	47393	104
15059	130	3102015	403	46124	429	46952	444	47394	104
15060	130	3102020	403	46125	429	46960	444	47395	104
15061	130	3102040	403	46131	429	46988	447	47396	104
15062	130	3102120	404	46132	429	46989	447	47397	104
15063	130	3102220	403	46134	429	47002	156	47398	104
15064	130	3300-TT	122	46137	429	47003	156	47399	104
15065	130	3316-13TT	122	46221	438	47004	156	47400	104
15067	130	3324-13TT	122	46285	434	47005	156	47401	104
15068	130	3324C-BBTT	122	4635110	434	47025	144	47402	104
15069	130	3332-13TT	122	4635210	435	47026	144	47403	104
15070	130	3616	498	4635810	434	47027	144	47404	104
15072	130	3628	498	4644010	428	47028	144	4741-06	499
15073	130	3632	498	4644020	428	47029	144	4743-06	499
15076	130	3648	498	46527	309	47031	144	4747	499
15078	130	3664	498	46569	437	47046	111	47488	307, 312
15081	130	3805-06	513	46582	437	47049	111	47490	307, 312
15082	130	3820-28	513	46584	437	47054	144	47602	500
15083	130	400N	132	46585	437	47058	144	47619	437
15085	130	401N	132	46586	437	47104	497	47632	437
15086	130	402NC	132	46587	437	47118	145	4763215	437
15103	137	403NH	133	46588	144	47119	145	4763250	437
15104	137	4075502	302	46589	145	47139	104	4763260	437

# Numerical index

Índice numérico  
Index numérique

REF.	PAG.	REF.	PAG.	REF.	PAG.	REF.	PAG.	REF.	PAG.
47634	437	484C	132	5284320	105	64132	101	69410	45
4763415	437	485	133	5292620	105	64134	101	69412	45
4763450	437	4916-13	122	5303	92	6414015	101	69414	45
4763460	437	4924-13	122	5324-13	123	6414030	101	69523	290
47635	437	4932-13	122	55457	129	6414040	101	6954702	290
4763515	437	49410	408	55458	129	6414050	101	6954703	290
4763550	437	49411	408	55459	129	6414070	101	6958302	291
4763560	437	49412	409	55460	129	6414215	101	6958303	291
47637	437	49413	408	55470	129	6414230	101	700-1	134
47703	131	49414	408	55471	129	6414240	101	700-4	134
47713	131	49416	408	55472	129	6414250	101	704	134
47714	131	49417	408	55473	129	6414270	101	706	134
47715	131	49418	408	55477	129	6422220	103	708	134
4780610	110	49419	409	55478	129	6422335	103	712	134
4780620	109	49420	409	55479	129	6422865	103	7217310	309
4780630	109	49423	409	55480	129	6432120	103	7217350	309
4780640	109	49424	408	55481	129	6433120	103	7217355	309
4780650	109	49425	408	55482	129	6433220	103	7217360	309
4780660	109	49426	409	55483	129	6433230	103	7217410	309
4780670	109	49427	409	55484	129	6433335	103	7217450	309
4780910	110	49428	408	55485	129	6433445	103	7217455	309
4780912	110	49429	409	55486	129	6433480	103	7217460	309
4780920	109	49430	408	55490	129	6433620	103	7217810	309
4780922	110	49431	409	55491	129	6433655	103	7217850	309
4780930	109	49432	409	55492	129	6433865	103	7217855	309
4780940	109	49433	409	55493	129	64403	444	7217860	309
4780950	109	49435	409	55494	129	64404	444	7217910	309
4780960	109	49441	408	595027502	293	64406	444	7217950	309
4780970	109	49442	409	595027503	293	64407	444	7217955	309
4780980	109	49445	409	595087502	293	6512-06	515	7217960	309
4781210	110	4961-1301	123	595087503	293	6535-13	515	72522	312
4781212	110	4961-1308	123	59601	289	6706CC	93	72550	313
4781220	109	4961-13191	123	59602	289	6706HC	93	72630	313
4781222	110	4961-1332	123	59641	293	6706N	93	74110210	307
4781230	109	4980120	98	59642	293	6708CC	93	74110240	307
4781240	109	4980230	98	59650	289	6708HC	93	741102D	307
4781250	109	4980335	98	59651	289	6708N	93	74110310	307
4781260	109	4980422	309	606N	134	6709CC	93	74110340	307
4781270	109	4980445	98	62300	485	6709N	93	741103D	307
4781280	109	4980622	309	62301	485	6710CC	93	7470210	307
4781610	110	4980655	98	62303	485	6710N	93	7470240	307
4781612	110	4980865	98	62305	485	6712CC	93	74702D	307
4781620	109	500N	133	62309	485	6712N	93	7470310	307
4781622	110	501N	133	62311	485	671307	68	7470340	307
4781630	109	509	133	62312	485	671308	68	74703D	307
4781640	109	511	133	62313	485	671310	68	75013	404
4781650	109	52160	507	62314	485	671312	68	75015	404
4781660	109	52162	507	62315	485	671314	68	7512-06	515
4781670	109	52164	507	62318	485	6714CC	93	77519	45
4790910	110	52170	507	62321	485	6714HC	93	77520	45
4791210	35,110	52172	507	62322	485	6714N	93	77521	45
4791610	35,110	52174	507	62323	485	6716CC	93	77522	45
47933	155	5220	92	62325	485	6716HC	93	77523	45
47934	155	5223	92	62326	485	6716N	93	77739	45
47935	155	5228	92	62327	485	68296	146	77740	45
47938	155	52640	237	623					

# Numerical index

Índice numérico  
Index numérique

REF.	PAG.	REF.	PAG.	REF.	PAG.	REF.	PAG.	REF.	PAG.
78740	433	90043	201	CFIFO-4	515	LS03IVB-T1	512	P100827	473
78760	433	90052	200	CT2-23035002	297	LS03MS18B-T5	512	P100836	473
808N	134	90053	201	CT2-23035003	297	LS03MVS18B-T5	512	P100837	473
82093	438	90062	200	CT4-2301000	297	LS03PB-T1	512	P100838	473
82094	438	90063	201	CT4-23080002	297	LS03PS18B-T1	512	P100840	476
82095	438	90082	200	CT4-23080003	297	LS03PVB-T1	512	P100841	476
8230210	409	90102	200	CT4-230DUAL	296	M1-L-T1	511	P100851	476
8230720	409	90112	200	CT4H-230950	296	M2V-LL-T1-T1	511	P100860	476
8231420	409	90142	200	CTC-3X2V	515	M3V-LLL-T1-T1-T1	511	P100861	476
8231810	409	90162	200	CTCL-4B	514	M4V-4L-T1-T1-T1-T1	511	P100862	476
8240016	411	90182	200	CTFWH-8B	514	MBA92821	394	P100871	476
8242010	410	90202	200	CTNO-06	515	N-0001B	198	P100880	476
8242014	410	90212	200	G58807	514	N-0002B	198	P100881	476
8242310	410	90213	201	HPI4-260002	288	N-0003B	198	P100882	476
8242314	410	90222	200	HPI4-260003	288	N-0006B	198	P100890	476
8242414	410	90223	201	HPI4-260004	288	P1	511	P100891	476
8242514	410	90242	200	HPI4-300002	288	P100003P	198	P100892	476
8242610	410	90243	201	HPI4-300003	288	P100004P	198	P100900	475
8242614	410	90252	200	HPI4-300004	288	P100005P	198	P100931	477
8242710	410	90262	200	HPI4-380002	288	P100006P	198	P100932	477
8242714	410	90263	201	HPI4-380003	288	P100008P	198	P100940	477
8242810	411	90282	200	HPI4-380004	288	P100511	468	P100950	477
8242814	411	90302	201	INC-80	511, 513	P100512	468	P100951	477
8242914	411	90312	201	INC-80S18	513	P100520	468	P100955	477
8243014	411	90322	201	J1-L-T5	512	P100521	468	P100960	477
8243114	411	90342	201	J2H-LL-T5-T5	512	P100522	468	P100965	477
8243210	411	90352	201	J2V-LL-T5-T5	512	P100530	469	P103322	59
8243214	411	90362	201	J3V-LLL-T5-T5-T5	512	P100531	469	P104318	59
8243314	411	90382	201	K1-L	511	P100540	469	P104320	59
86100	222	90502	200	K1LLDS-T1	512	P100541	469	P104324	59
86101	222	90512	200	K2H-LC-T1-T2	511	P100542	469	P106320	59
86103	222	90522	200	K2H-LL-T1-T1	511	P100543	469	P106324	59
86104	222	90542	200	K2H-LP-T1-T4	511	P100544	469	P109035	117
86105	222	90552	200	K2VCLDS-T1-T2	512	P100550	469	P109040	117
86106	222	90562	200	K2V-LC-T1-T2	511	P100551	469	P109045	117
86107	222	90622	201	K2VLLDS-T1-T1	512	P100552	469	P109050	117
86108	222	90642	201	K2V-LL-T1-T1	511	P100553	469	P110000	197
86109	222	90662	201	K2V-LP-T1-T4	511	P100554	469	P110004	197
86110	222	90682	201	K3H-LCC-T1-T2-T2	511	P100570	469	P110004A	33
86111	222	90922	201	K3H-LCP-T1-T2-T4	511	P100571	469	P110004EO	197
86113	222	90942	201	K3H-LCS-T1-T2-T3	511	P100572	469	P110005	197
86114	222	918-13	485	K3H-LLL-T1-T1-T1	511	P100600	468	P1100BF	204
86115	222	93100	201	K3VCLCDS-T1-T2-T2	512	P100601	468	P1100C1	201, 207
86116	222	93110	201	K3V-LCC-T1-T2-T2	511	P100740	474	P1100P1	197, 203, 207
86117	222	93200	201	K3V-LCP-T1-T2-T4	511	P100741	474	P1100P2	197, 203
86118	222	93300	201	K3V-LCS-T1-T2-T3	511	P100742	474	P1100P3	197, 203
86119	222	93400	201	K3V-LLL-T1-T1-T1	511	P100754	474	P1100P4	197, 203
86120	222	93500	201	K4H-LCCC-T1-T2-T2-T2511	P100755	474	P1100P5	197, 203	
86121	222	93600	201	K4H-LCCP-T1-T2-T2-T4511	P100760	474	P1100P6	208	
86123	222	93900	201	K4H-LCCS-T1-T2-T2-T3511	P100761	474	P110101	154, 194	
86124	222	95160	146	K4H-LLCC-T1-T1-T2-T2511	P100770	474	P110201	194	
86125	222	95320	146	K4V-LCCC-T1-T2-T2-T2511	P100780	474	P110202	196	
86126	222	95640	146	K4V-LCCP-T1-T2-T2-T4511	P100792	475	P110401	194	
86127	222	97004	245	K4V-LCCS-T1-T2-T2-T3511	P100803	475	P110402	196	
86128	222	97005	245	K4V-LLCC-T1-T1-T2-T2511	P100804	475	P110551	194	
86129	222	97006	245	K4X-LCCC-T1-T2-T2-T2511	P100805	475	P110552	196	
88184	307	97007	245	K4X-LCCP-T1-T2-T2-T4511	P100807	473	P110651	194	
88204	307	97168	249	K4X-LCCS-T1-T2-T2-T3511	P100808	473	P110652	196	
90002	200	97208	249	K4X-LLCC-T1-T1-T2-T2511	P100813	475	P1106BF	204	
90012	200	99710	237	LD2-2	513	P100814	475	P1106C1	201
90013	201	ADC-4	261	LD3-2	513	P100816	473	P1106F1	199
9002	92	ADP	261	LDS-3	515	P100817	473	P1106F3	401
90022	200	CADJ-1	513	LDS-4CUP	515	P100820	475	P1106F3A	401
90023	201	CADJ-2	513	LS03IB-T1	512	P100821	475	P1106F3G	401
90042	200	CADJ-3	511, 513	LS03IS18B-T1	512	P100826	473	P1106F3N	401

# Numerical index

Índice numérico  
Index numérique

REF.	PAG.	REF.	PAG.	REF.	PAG.	REF.	PAG.	REF.	PAG.
P1106F3R	401	P118328	58	P122050	88	P1306BF	204	P141028	60
P1106P1	206	P118332	58	P122060	88	P1306C1	201	P141028B	399
P111001	194	P118335	58	P1220BF	204	P1306P1	207	P141032	60
P111002	196	P118340	58	P1220C1	201	P131001	194	P141032B	399
P1110BF	204	P118345	58	P1220P1	206	P131002	196	P141036	60
P1110C1	201	P118350	58	P122222	195	P131022	76	P141040	60
P1110F1	199	P118360	58	P123040	91	P131026	76	P1410BF	204
P1110F2	199	P120000	197	P123060	91	P1310BF	204	P1410C1	201
P1110P1	206	P120004	197	P123140	91	P1310C1	201	P1410P1	207
P111111	195	P120004A	33	P123160	91	P1310P1	207	P14126	239
P111501	194	P120004EO	197	P123260	91	P131120	400	P14126F1	239
P111502	196	P120005	197	P124024	76	P131165	400	P141501	195
P1115BF	204	P120018	74	P124028	76	P131220	400	P1415BF	204
P1115C1	201	P120020	74	P124032	76	P131265	400	P1415C1	201
P1115F1	199	P120022	74	P124036	76	P131501	194	P1415P1	207
P1115F2	199	P120024	74	P124040	76	P131502	196	P142000	80
P1115P1	206	P120026	74	P125000	195	P1315BF	204	P142001	195
P1115P6	208	P120028	74	P125038	76	P1315C1	201	P142100	79
P112001	194	P120032	74	P1250BF	204	P1315P1	207	P145000	195
P112002	196	P120036	74	P1250C1	201	P1315P6	208	P1450BF	204
P1120BF	204	P120040	74	P127024	75	P132001	195	P1450C1	201
P1120C1	201	P1200BF	204	P127028	75	P132002	196	P148020	75
P1120P1	206	P1200C1	201, 207	P127032	75	P132040	91	P148024	75
P112324	58	P1200P1	197, 203, 207	P127040	75	P132060	91	P148028	75
P112328	59	P1200P2	197, 203	P128018	74	P1320C1	201	P148032	75
P112332	59	P1200P3	197, 203	P128020	74	P1320P1	207	P149120	78
P112335	59	P1200P4	197, 203	P128022	74	P132140	91	P149124	78
P112340	59	P1200P5	197, 203	P128024	74	P132160	91	P149128	78
P112345	59	P1200P6	208	P128026	74	P132260	91	P149130	78
P112350	59	P120101	154, 194	P128028	74	P132365	89	P149228	78
P112360	59	P120201	194	P128032	74	P132560	89	P149330	79
P113035	88	P120401	194	P128036	74	P135000	195	P149520	80
P113040	88	P120651	194	P128040	74	P1350BF	204	P149524	80
P113050	88	P120652	196	P128124	75	P1350C1	201	P149528	80
P113060	88	P1206BF	204	P128128	75	P135120	83	P15000	295
P113070	88	P1206C1	201	P128132	75	P135124	83	P15001	295
P114040	88	P1206F1	199	P128224	75	P135128	83	P15002	295
P114050	88	P1206F3	401	P128228	75	P135132	83	P150028	80
P114060	88	P1206F3A	401	P128232	75	P135140	83	P15003	295
P114070	88	P1206F3G	401	P128324	75	P135330	83	P15004	301
P114540	88	P1206F3N	401	P128328	75	P135424	83	P15005	301
P114545	88	P1206F3R	401	P128332	75	P136006	169	P15006	301
P115000	195, 254	P1206P1	206	P128424	75	P136007	169	P15007	301
P1150BF	204	P120820	73	P128428	75	P136008	169	P15008	301
P1150C1	201	P120824	73	P128432	75	P139012	76	P15010	318
P115320	58	P120828	73	P128920	73	P140000	197	P150128	79
P115324	58	P120832	73	P128924	73	P140004	197	P15020	313
P115340	58	P120920	73	P128928	73	P1400BF	204	P15027	321
P116324	58	P120924	73	P128932	73	P1400C1	201, 207	P15028	321
P116328	58	P120928	73	P130000	197	P1400P1	197, 203, 207	P15029	315
P116332	58	P120932	73	P130004	197	P1400P2	197, 203	P15030	315
P116335	58	P121001	194	P1300BF	204	P1400P3	197, 203	P15033	316
P116340	58	P121002	196	P1300C1	201, 207	P1400P4	197, 203	P15034	316
P116345	58	P1210BF	204						

# Numerical index

Índice numérico  
Index numérique

REF.	PAG.	REF.	PAG.	REF.	PAG.	REF.	PAG.	REF.	PAG.
P15077	291	P169020	81	P200320	50	P21017	451	P218040	48
P15078	290	P169024	81	P200324	50	P21020	451	P218045	48
P15079	291	P169028	81	P20041	484	P210201	194	P218050	48
P15081	294	P169030	81	P20042	484	P210202	196	P218060	48
P15089	303	P170020	61	P20050	484	P21027	451	P22000	367
P15090	303	P170024	61	P20066	484	P21028	451	P22001	367
P15091	303	P170028	61	P20069	484	P210401	194	P220018	70
P15096	318	P171024	61	P20072	419	P210402	196	P22002	366
P15097	318	P171028	61	P201016	49	P210651	194	P220020	70
P151012	60, 459	P173016	61	P201018	49	P210652	196	P220021	366
P151014	60, 459	P190000	197	P201020	49	P211001	194	P220022	70
P151016	60, 459	P1900BF	204	P201024	49	P211002	196	P220023	366
P151020	60	P1900C1	201, 207	P201028	49	P21105	239	P220024	70
P151020B	399	P1900P1	197, 203, 207	P201032	49	P21105F1	239	P220026	70
P151024	60	P1900P2	197, 203	P20115	239	P211501	194	P220028	70
P151024B	399	P1900P3	197, 203	P20115F1	239	P211502	196	P22003	365
P151028	60	P1900P4	197, 203	P202016	49	P212001	194	P220031	365
P151028B	399	P1900P5	197, 203	P202018	49	P212002	196	P220032	70
P151032	60	P19060	394	P202020	49	P213018	71	P220033	365
P15105	239	P190651	195	P202024	49	P213020	71	P220036	70
P15105F1	239	P1906BF	204	P202028	49	P213022	71	P22004	367
P151100	459	P1906C1	201	P202032	49	P213024	71	P220040	70
P151200	459	P1906P1	207	P203016	50	P213026	71	P22005	367
P151300	459	P19090	394	P203018	50	P213028	71	P22006	378
P151400	459	P19100	450	P203020	50	P213032	71	P22007	378
P152025	88	P191001	195	P203024	50	P213036	71	P22008	378
P152030	88	P19101	450	P204020	50	P213040	71	P22009	375
P152035	88	P19103	450	P204024	50	P214016	49	P22010	375
P152035B	399	P19104	450	P204028	50	P214018	49	P22011	375
P152935	399	P19105	450	P204030	50	P214020	49	P22012	367
P153025	79	P19106	450	P204032	50	P214022	49	P22013	367
P153034	79	P19107	450	P204035	50	P214024	49	P22014	367
P153050	79	P1910BF	204	P204040	50	P215000	195, 254	P22015	367
P154020	33, 399	P1910C1	201	P205020	48	P216016	48	P22016	367
P154024	33, 399	P1910P1	207	P205024	48	P216018	48	P22019	370
P154028	33, 399	P19114A	450	P205028	48	P216020	48	P22020	370
P154032	33, 399	P19114N	450	P205030	48	P216024	48	P22022	370
P160000	197	P19114R	450	P205032	48	P216028	48	P22023	370
P160004	197	P19115A	450	P205035	48	P216030	48	P220203	383
P1600BF	204	P19115N	450	P205040	48	P216032	48	P22031	383
P1600C1	201, 207	P19115R	450	P205045	48	P216035	48	P22033	369
P1600P1	197, 203, 207	P19116	450	P205050	48	P216040	48	P22034	369
P1600P2	197, 203	P19117	450	P205060	48	P216045	48	P22035	383
P1600P3	197, 203	P19118	450	P209016	49	P216050	48	P22036	383
P1600P4	197, 203	P19120	394	P209018	49	P216060	48	P22037	364
P1600P5	197, 203	P19126	239	P209020	49	P217016	48	P22038	364
P1600P6	208	P19126F1	239	P209020A	33	P217018	48	P22039	375
P160651	195	P192118	75	P209024	49	P217020	48	P22040	378
P1606BF	204	P192120	75	P209024A	33	P217024	48	P22041	375
P1606C1	201	P192124	75	P209028	49	P217028	48	P22042	378
P1606P1	207	P192128	75	P209028A	33	P217030	48	P22043	375
P161001	195	P192132	75	P209030	49	P217032	48	P22044	378
P161034	60	P192136	75	P209032	49	P217035	48	P22045	375
P161038	60	P192140	75	P209032A	33	P217040	48	P22046	378
P1610BF	204	P195000	465	P209035	49	P217045	48	P22047	375
P1610C1	201	P200012	49	P209040	49	P217050	48	P22048	378
P1610P1	207	P200014	49	P209045	49	P217060	48	P22049	375
P161501	195	P200016	49	P209050	49	P218016	48	P22050	378
P1615BF	204	P200018	49	P209060	49	P218018	48	P22051	375
P1615C1	201	P200020	49	P21000	451	P218020	48	P22052	378
P1615P1	207	P200022	49	P21001	451	P218024	48	P22053	375
P1615P6	208	P200024	49	P21003	451	P218028	48	P22054	378
P162001	195	P200028	49	P21005	451	P218030	48	P22079	378
P1650BF	204	P200116	49	P21015	451	P218032	48	P22080	375
P166032	81	P200120	49	P21016	451	P218035	48	P22081	378

# Numerical index

Índice numérico  
Index numérique

REF.	PAG.	REF.	PAG.	REF.	PAG.	REF.	PAG.	REF.	PAG.
P22082	375	P22179	369	P22330	346	P22388	334	P22691	372
P220820	71	P22180	369	P22331	346	P22389	334	P22692	372
P220824	71	P22181	369	P22332	347	P22390	334	P22695	373
P220828	71	P22182	368	P22333	346	P22391	334	P22696	373
P22083	378	P22183	368	P22334	346	P22393	334	P22697	373
P220832	71	P22184	368	P22335	346	P22394	334	P22698	373
P22084	375	P22185	383	P22336	350	P22399	339	P22700	353
P22085	367	P22200	366	P22337	350	P22400	339	P22701	353
P22086	367	P22200A	366	P22338	350	P22401	339	P22702	353
P22087	378	P22200AM	366	P22339	350	P22402	339	P22703	353
P22088	380	P22200N	366	P22340	350	P224023	52	P22704	353
P22090	370	P22200R	366	P22341	350	P224026	52	P22705	353
P22094	378	P22200V	366	P22342	350	P22403	339	P22710	353
P22099	367	P22201	366	P22343	350	P22404	338	P22711	353
P22100	365	P22202	366	P22344	349	P22405	338	P22712	353
P22101	365	P22202A	366	P22345	349	P22406	338	P22720	356
P22102	365	P22202AM	366	P22346	349	P22407	338	P22725	356
P22103	364	P22202N	366	P22347	349	P22408	338	P22726	356
P22104	380	P22202R	366	P22348	349	P22409	335	P22727	356
P22105	380	P22202V	366	P22349	363	P22410	335	P22728	356
P22106	380	P22203	366	P22350	363	P22411	335	P22729	356
P22108	380	P22203A	366	P22351	363	P22412	335	P22740	352
P22109	380	P22203AM	366	P22352	363	P22413	336	P22741	352
P22110	380	P22203N	366	P22353	363	P22414	336	P22742	352
P22111	368	P22203R	366	P22354	361	P22415	336	P22743	352
P22112	368	P22203V	366	P22355	361	P22416	336	P22744	352
P22113	368	P22204	366	P22356	361	P22417	336	P22745	352
P22114	368	P22211	366	P22357	361	P22418	336	P22746	352
P22115	368	P22220	365	P22358	361	P22419	335	P22750	352
P22116	368	P22221	365	P22359	363	P22420	363	P22751	352
P22117	369	P22222	365	P22360	363	P22421	363	P22752	352
P22118	369	P22223	358	P22361	340, 395	P22422	345	P22755	352
P22119	380	P22250	369	P22362	340, 395	P22423	345	P22756	352
P22120	382	P22251	369	P22363	340, 395	P22424	342	P22758	356
P22124	373	P22301	345	P22364	340, 395	P22425	342	P22759	356
P22125	373	P22302	345	P22365	340, 395	P22426	342	P22760	352
P22126	373	P22303	345	P22366	340, 395	P22427	342	P22770	353
P22127	342	P223035	52	P22367	340, 395	P22501	365	P22772	353
P22128	342	P22304	345	P22368	337	P22502	365	P22775	351
P22129	342	P223040	52	P22369	337	P22600	371	P22778	351
P22144	373	P22305	345	P22370	337	P22601	371	P22779	351
P22145	373	P22306	345	P22370A	359	P22602	371	P22780	356
P22150	367	P22307	345	P22370G	359	P22603	371	P22781	356
P22151	367	P22308	344	P22370N	359	P22604	371	P22782	356
P22154	379	P22309	344	P22370R	359	P22610B	371	P22783	356
P22156	379	P22310	348	P22371	337	P22610N	371	P22784	356
P22158	379	P22311	348	P22371A	359	P22611B	371	P22800	354
P22160	379	P22312	348	P22371G	359	P22611N	371	P22801	354
P22161	372	P22313	348	P22371N	359	P22614B	371	P22802	354
P22162	372	P22314	348	P22371R	359	P22614N	371	P22803	354
P22164	364	P22315	348	P22372	337	P22620	371	P22815	354
P22165	364	P22316	348	P22373	341	P22621	371	P22816	354
P22166	364	P22317	348	P22374	341	P22622	371	P22817	354
P22167	365	P22318	347	P22375	341	P22640N	372	P22823	354
P22168	365	P22319	347	P22376	341	P22641N	372	P22824	354
P22169	363	P22320	347	P22377	334	P22642N	372	P22825	354
P22170	363	P22321	347	P22378	334	P22650	342	P22830	357
P22171									

# Numerical index

Índice numérico  
Index numérique

# Numerical index

Índice numérico  
Index numérique

REF.	PAG.	REF.	PAG.	REF.	PAG.	REF.	PAG.	REF.	PAG.
P22851	354	P23008	505	P239436	77	P28502	467	P307025	154
P22852	354	P23009	505	P239536	77	P28503	467	P307030	154
P22860	374	P230101	154, 194	P23990	351	P28504	467	P307035	154
P22861	374	P23015	505	P23991	351	P28505	467	P307040	154
P22862	374	P230201	194	P23992	351	P28506	467	P307045	154
P22863	374	P230202	196	P23993	351	P28600	466	P307050	154
P22864	374	P23030	377	P240040	51	P28610	466	P307060	154
P22865	374	P23031	377	P240050	51	P28620	466	P307070	154
P22866	374	P23032	377	P240401	194	P28621	466	P307125	154
P22867	374	P23033	377	P240651	194	P29600	465	P307130	154
P22868	374	P23034	377	P241001	194	P29610	465	P307140	154
P22869	374	P23036	377	P241040	51	P29620	465	P307150	154
P22870	374	P23037	377	P241050	51	P29630	465	P308030	117
P22871	374	P23038	377	P241501	194	P296415	464	P308035	117
P22872	374	P23039	377	P242024	51	P296430	464	P308040	117
P22873	374	P23040	377	P242028	51	P2965001	465	P308045	117
P22874	374	P230401	194	P242032	51	P296515	464	P308050	117
P22875	374	P230402	196	P242035	51	P296530	464	P309040	88
P22876	374	P23042	377	P243024	51	P296615	464	P309050	88
P22877	374	P23043	377	P243028	51	P296630	464	P309060	88
P22878	374	P23044	377	P243032	51	P296715	464	P310000	493
P22879	374	P23045	377	P243035	51	P296730	464	P311002	492
P22880	374	P23046	377	P244020	52	P29680	465	P311004	493
P22881	374	P230651	194	P244024	52	P300024	117	P311006	492
P22882	374	P230652	196	P244028	52	P300030	117	P311020	493
P22883	374	P231001	194	P244032	52	P300325	117	P311071	492
P22884	349	P231002	196	P244035	52	P300335	117	P312000	493
P22884A	358	P231501	194	P24407	456	P300340	117	P313025	118
P22884B	358	P231502	196	P24409	456	P30084	239	P313030	118
P22884G	358	P232001	194	P24410	456	P30084F1	239	P313126	118
P22884N	358	P232002	196	P24411	456	P301108	98	P313132	118
P22884NE	358	P234020	50	P24412	457	P301109	98	P314110	99
P22884R	358	P234024	50	P24413	457	P301110	98	P314112	99
P22885	349	P23500	460	P24414	457	P301112	98	P314210	99
P22886	349	P235000	195	P24415	457	P301114	98	P314212	99
P22887	349	P23501	460	P24704	455	P301116	98	P314300	99
P22888	344	P23502	460	P24705	455	P301118	98	P315010	99
P22889	344	P23503	460	P24706	455	P301165	98	P315012	99
P22890	380	P23504	461	P24707	455	P301206	98	P315015	99
P22891	344	P23505	461	P24708	455	P301208	98	P315017	99
P22892	344	P23506	461	P24709	455	P301210	98	P315020	99
P22893	344	P23507	461	P24710	455	P301212	98	P316025	156
P22894	344	P23508	461	P24711	455	P301214	98	P316030	156
P22895	345	P23509	461	P24712	455	P301216	98	P316035	156
P22896	344	P23800	381	P24713	455	P302108	99	P316040	156
P22897	344	P23800A	358	P24714	454	P302110	99	P316045	156
P22898	344	P23800G	358	P24715	454	P302112	99	P316050	156
P22899	344	P23800N	358	P24716	454	P302114	99	P316125	156
P22901	360	P23800R	358	P24717	454	P302116	99	P316130	156
P22902	360	P23810	381	P24718	454	P302118	99	P316135	156
P22911	360	P23824	381	P24719	454	P302120	99	P316140	156
P22912	360	P23825	381	P248028	52	P302210	99	P316145	156
P22920	382	P23830	381	P248032	52	P302212	99	P316150	156
P22930	382	P23835	381	P248035	52	P302214	99	P317025	438
P22940	360	P23836	381	P248040	52	P302216	99	P317030	438
P22950	360	P23840	381	P248045	52	P303016	116	P317035	438
P22960	360	P23841	381	P26000	149	P303018	116	P317040	438
P22971	360	P23842	382	P26001	149	P303020	116	P317045	438
P22972	360	P23843	382	P26100	498	P303022	116	P317050	438
P22973	363	P23844	382	P28202	467	P303024	116	P317100B	389
P22974	363	P23845	382	P28252	467	P303026	116	P317100G	389
P22975	363	P239036	77	P28302	467	P303200	116	P317100S	389
P230000	197	P239136	77	P28303	467	P303265	98	P317200B	389
P23003	505	P239236	72	P28403	467	P306035	154	P317200G	389
P23004	505	P239336	72	P28501	467	P307020	154	P317200S	389

REF.	PAG.	REF.	PAG.	REF.	PAG.	REF.	PAG.		
P317300B	389	P335002	508	P356028	155	P381008	113	P459024	72
P317300G	389	P33621	445	P356032	155	P381010	113	P459028	72
P317300S	389	P33622	445	P357000	483	P382000	113	P460018	76
P317400B	389	P33623	445	P358024	108	P383000	113	P460020	76
P317400G	389	P33624	445	P358029	108	P384000	113	P460024	76
P317400S	389	P33625	445	P358040	108	P385020	112	P460026	76
P317425	438	P337030	507	P358230	447	P385026	112	P460028	76
P317430	438	P337060	507	P358231	447	P385030	112	P460030	76
P317435	438	P337090	507	P358232	447	P385500	114	P460032	76
P317440	438	P337150	507	P358237	447	P386000	113	P490014A	55
P317445	438	P337200	507	P358241	108	P387065	431	P490014G	55
P317450	438	P33801	446	P358242	108	P387100	432	P490014N	55
P317500B	388	P33802	446	P358243	108	P387200	432	P490014R	55
P317500G	388	P33803	446	P358244	108	P387500	430	P490016A	55
P317500S	388	P33804	446	P358245	108	P388018	497	P490016G	55
P318005	89	P33805	446	P358246	108	P389000	449	P490016N	55
P318040	90	P33806	446	P358247	108	P390000	138	P490016R	55
P318060	90	P33807	446	P358301	108	P390100	138	P490220A	71
P318100	497	P33808	446	P358302	108	P391000	120	P490220G	71
P318211	89	P33809	446	P358303	108	P392065	98	P490220N	71
P319000	497	P340000	222	P358304	108	P393080	156	P490220R	71
P319100	497	P341000	443	P358305	108	P393100	156	P490224A	71
P32083	239	P342000	443	P358306	108	P393125	156	P490224G	71
P32083F1	239	P343000	443	P358307	108	P394008	100	P490224N	71
P322101	121	P343400	107	P358404	108	P394012	100	P490224R	71
P322102	121	P343600	107	P358407	108	P395038	101	P490228A	71
P322103	121	P343700	107	P359000	448	P397247	101	P490228G	71
P322104	121	P343800	107	P361000	441	P397347	101	P490228N	71
P322201	121	P344000	443	P361100	442	P398024	157	P490228R	71
P322202	121	P345000	443	P362000	441	P398035	157	P490620A	55
P322203	121	P347020	116	P362100	442	P398042	157	P490620G	55
P322204	123	P347024	116	P363000	441	P398125	157	P490620N	55
P324013	115	P348008	115	P363100	442	P398135	157	P490620R	55
P324016	115	P348010	115	P364000	441	P398140	157	P490624A	55
P324019	115	P348012	115	P364100	442	P398225	157	P490624G	55
P324022	115	P348015	115	P365000	441	P398235	157	P490624N	55
P324025	115	P348018	115	P365100	442	P398240	157	P490624R	55
P325008	115	P350230	161	P366000	441	P398290	157	P490628A	55
P325010	115	P350235	161	P367000	441	P399000	497	P490628G	55
P325012	115	P350330	161	P367100	442	P399400	499	P490628N	55
P325015	115	P350335	161	P368000	441	P399500	499	P490628R	55
P325018	115	P350426	161	P369000	441	P399600	499	P490632A	55
P325020	115	P350430	161	P369100	442	P41001	463	P490632G	55
P326000	492	P350435	161	P372200	432	P41002	463	P490632N	55
P327000	493	P350440	161	P373020	115	P41003	463	P490632R	55
P328020	120	P350530	161	P373024	115	P41004	463	P490724A	55
P328023	120	P350535	161	P373028	115	P41005	479	P490724G	55
P328600	120	P350630	161	P374013	115	P41006	479	P490724N	55
P330035	496	P350635	161	P374015	115	P41007	479	P490724R	55
P330050	496	P350730	161	P374018	115	P41008	462	P490728A	55
P330070	496	P350735	161	P374020	115	P41009	462	P490728G	55
P331039	152	P351000	448	P374026	115	P41010	462	P490728N	55
P331044	152	P352000	448	P375010	114	P41011	462	P490728R	55
P331050	152	P353000	448	P375030	115	P41012	480	P490732A	55
P331056	152	P354025	156	P375035	115	P41013	480	P490732G	55
P331059	152	P354030	156	P375061	114	P41014	480	P490732N	55
P331066	152	P354035	156	P375070	114	P41015	480	P490732R	55
P331070	152	P354040	156	P375110	114	P41016	480	P490928A	

# Numerical index

Índice numérico  
Index numérique

REF.	PAG.	REF.	PAG.	REF.	PAG.	REF.	PAG.	REF.	PAG.
P5000	236	P5360E3F1	235	P597120	392	P632024	481	P7010	268
P5001	236	P5360E4	233	P597130	392	P632025	481	P7011	268
P5002	236	P5360E4F1	235	P597140	393	P632026	481	P7012	268
P5003	236	P5360E5	233	P597150	393	P632027	481	P7013	268
P5004	237	P5360E5F1	235	P597160	393	P632028	481	P7014	268
P5015	260	P5360F1	234	P597170	392	P632029	481	P7015	268
P5017	260	P5361	231	P598001	386	P632030	481	P7016	268
P5018	237	P5361F1	234	P598002	386	P633000	481	P7017	268
P5019	237	P5490	231	P598003	386	P633002	481	P7018	268
P501F1	227	P5490E1	233	P598700	396	P633003	481	P7019	268
P501F2	227	P5490E1F1	235	P598800	396	P634000	481	P7020	268
P501F3	227	P5490E2	233	P603012	146	P635000	484	P702026	163
P501F4	227	P5490E2F1	235	P603015	146	P636000	484	P702028	163
P501F5	227	P5490E3	233	P604001	146	P637000	484	P7021	268
P501F6	227	P5490E3F1	235	P604002	146	P637100	484	P7022	268
P5062	236	P5490E4	233	P604500	145	P638000	483	P702230	163
P508015	316	P5490E4F1	235	P605000	448	P638003	480	P7023	268
P5090	230	P5490E5	233	P606000	448	P638004	480	P7024	268
P5090E1	232	P5490E5F1	235	P607000	95	P639000	483	P7025	268
P5090E1F1	235	P5490F1	234	P607100	95	P640000	244	P7026	268
P5090E2	232	P5491	231	P609010	147	P641100	244	P7027	268
P5090E2F1	235	P5491F1	234	P609200	147	P642000	244	P7028	268
P5090E3	232	P590001	396	P609705	147	P643000	244	P7029	268
P5090E3F1	235	P590002	396	P610000	138	P644200	509	P7030	268
P5090E4	232	P590003	396	P611000	147	P644240	509	P703020	164
P5090E4F1	235	P590004	396	P611001	111	P644275	509	P703024	164
P5090E5	232	P590005	396	P615000	449	P646000	495	P703028	164
P5090E5F1	235	P590006	396	P616000	497	P646100	509	P703032	164
P5090F1	234	P590007	359	P617017	448	P646103	509	P7031	268
P5091	230	P590008	395	P618000	449	P646105	509	P7032	268
P5091F1	234	P590009	395	P619000	501	P646200	509	P7033	268
P5160	230	P590010	395	P619002	501	P646300	509	P7034	268
P5160E1	232	P590011	395	P620001	111	P646301	509	P7035	268
P5160E1F1	235	P590012	395	P621000	111	P646310	509	P7036	268
P5160E2	232	P590110	397	P623003	479	P646400	509	P7037	268
P5160E2F1	235	P590120	397	P625000	483	P649050	509	P7038	268
P5160E3	232	P590130	397	P630010	481	P649100	509	P7039	268
P5160E3F1	235	P590240	397	P630020	481	P650000	483	P7040	268
P5160E4	232	P591001	471	P630030	481	P685004	432	P704024	163
P5160E4F1	235	P591002	471	P630040	481	P688045	315	P704030	163
P5160E5	232	P591003	471	P63052	240	P688065	291	P7041	268
P5160E5F1	235	P591004	471	P63052F1	240	P688085	294	P7042	268
P5160F1	234	P591005	471	P632001	481	P688087	294	P7043	268
P5161	230	P591006	387	P632002	481	P688130	314	P7044	268
P5161F1	234	P591007	387	P632003	481	P688133	314	P7045	268
P5250	230	P595001	387	P632004	481	P688134	314	P7046	268
P5250E1	232	P595002	387	P632005	481	P688250	316	P7047	270
P5250E1F1	235	P595003	387	P632006	481	P688251	316	P7048	270
P5250E2	232	P595004	387	P632007	481	P688260	316	P7049	270
P5250E2F1	235	P595100	391	P632008	481	P688261	316	P7050	270
P5250E3	232	P595110	391	P632009	481	P688265	315	P705024	94
P5250E3F1	235	P595111	391	P632010	481	P688266	315	P705028	94
P5250E4	232	P595120	391	P632011	481	P7000	268	P705032	94
P5250E4F1	235	P595121	391	P632012	481	P7001	268	P7051	270
P5250E5	232	P595130	391	P632013	481	P7002	268	P7052	270
P5250E5F1	235	P595131	391	P632014	481	P7003	268	P7053	270
P5250F1	234	P595200	391	P632015	481	P7004	268	P7054	270
P5251	230	P595300	391	P632016	481	P7004R	274	P7055	270
P5251F1	234	P596110	390	P632017	481	P7005	268	P7056	270
P5360	231	P596111	390	P632018	481	P7005R	274	P7057	270
P5360E1	233	P596120	390	P632019	481	P7006	268	P7058	270
P5360E1F1	235	P596121	390	P632020	481	P7006R	274	P7059	270
P5360E2	233	P596130	390	P632021	481	P7007	268	P7060	270
P5360E2F1	235	P596131	390	P632022	481	P7008	268	P706039	163
P5360E3	233	P597110	392	P632023	481	P7009	268	P7061	270

# Numerical index

Índice numérico  
Index numérique

REF.	PAG.	REF.	PAG.	REF.	PAG.	REF.	PAG.	REF.	PAG.
P7062	270	P7111	272	P7170	268	P7218	270	P7280	272
P7063	270	P7112	272	P717008	165	P7219	270	P7281	272
P7064	270	P7113	272	P717010	165	P7220	270	P7282	269
P7065	270	P7114	272	P7171	268	P722000	165	P7283	269
P7066	270	P7115	272	P7172	268	P7221	270	P7284	269
P7067	270	P7116	272	P7173	268	P7222	270	P7285	269
P7068	270	P7117	272	P7174	268	P7223	270	P7286	269
P7069	270	P7118	272	P7175	268	P7224	270	P7287	269
P7070	270	P7119	272	P7176	268	P7225	270	P7288	269
P707039	163	P7120	272	P7177	268	P7226	270	P7289	269
P7071	270	P712022	164	P7178	268	P7227	270	P7290	269
P7072	270	P7121	272	P7179	268	P7228	270	P7291	269
P7073	270	P7122	272	P7180	268	P7229	270	P7292	269
P7074	270	P7123	272	P718006	165	P7230	270	P7293	269
P7075	270	P7124	272	P718008	165	P723024	164	P7294	269
P7076	270	P7125	272	P718010	165	P723028	164	P7295	269
P7077	270	P7126	272	P718011	165	P7231	270	P7296	269
P7078	270	P7127	272	P7181	268	P7232	270	P7297	269
P7079	270	P7128	272	P7182	268	P7233	270	P7298	269
P7080	270	P7129	272	P7183	268	P7234	270	P7299	269
P708008	164	P7130	272	P7184	268	P7235	272	P7300	269
P708022	164	P713075	165	P7185	268	P7236	272	P7301	269
P708024	164	P7131	272	P7186	268	P7237	272	P7302	269
P7081	270	P7132	272	P7187	268	P7238	272	P7303	269
P7082	270	P7133	272	P7188	270	P7239	272	P7304	269
P7083	270	P7134	272	P7189	270	P7240	272	P7305	269
P7084	270	P7135	272	P7190	270	P7241	272	P7306	269
P7085	270	P7136	272	P7191	270	P7242	272	P7307	269
P7086	270	P7137	272	P7192	270	P7243	272	P7308	269
P7087	270	P7138	272	P7193	270	P7244	272	P7309	269
P7088	270	P7139	272	P7194	270	P7245	272	P7310	269
P7089	270	P7140	272	P7195	270	P7246	272	P7311	269
P7090	270	P7141	268	P7196	270	P7247	272	P7312	269
P709035	163	P7142	268	P7197	270	P7248	272	P7313	269
P7091	270	P7143	268	P7198	270	P7249	272	P7314	269
P7092	270	P7144	268	P7199	270	P7250	272	P7315	269
P7093	270	P7145	268	P7200	270	P7251	272	P7316	269
P7094	272	P7145R	274	P720005	165	P7252	272	P7317	269
P7095	272	P7146	268	P720006	165	P7253	272	P7318	269
P7096	272	P7146R	274	P720007	165	P7254	272	P7319	269
P7097	272	P7147	268	P720008	165	P7255	272	P7320	269
P7098	272	P7147R	274	P720010	165	P7256	272	P732000	166
P7099	272	P7148	268	P720012	165	P7257	272	P7321	269
P7100	272	P7149	268	P7201	270	P7258	272	P7322	269
P710020	164	P7150	268	P7202	270	P7259	272	P7323	269
P710024	164	P715006	165	P7203	270	P7260	272	P7324	269
P710028	164	P7151	268	P7204	270	P7261	272	P7325	269
P7101	272	P7152	268	P7205	270	P7262	272	P7326	269
P7102	272	P7153	268	P7206	270	P7263	272	P7327	269
P710205	316	P7154	268	P7207	270	P7264	272	P7328	269
P710206	316	P7155	268	P7208	270	P7265	272	P7329	271
P7103	272	P7156	268	P7209	270	P7266	272	P7330	271
P7104	272	P7157	268	P7210	270	P7267	272	P733000	166
P7105	272	P7158	268	P721005	165	P7268	272	P7331	271
P7106	272	P7159	268	P721006	165	P7269	272	P7332	271
P7107	272	P7160	268	P721007	165	P7270	272	P7333	271
P7108	272	P7161	268	P721008	165	P7271	272	P7334	271
P7109	272	P7162	268	P721010	165	P7272	272	P7335	271
P7110	272	P7163	268	P7211	270	P7273	272	P7336	271
P711010	164	P7164	268	P7212	270	P7274	272	P7337	271
P711012</									

# Numerical index

Índice numérico  
Index numérique

REF.	PAG.	REF.	PAG.	REF.	PAG.	REF.	PAG.	REF.	PAG.
P7343	271	P7406	273	P7471	271	P7536	273	P7605	274
P7344	271	P7407	273	P7472	271	P7537	273	P7606	274
P7345	271	P7408	273	P7473	271	P7538	273	P7607	274
P7346	271	P7409	273	P7474	271	P7539	273	P7608	274
P7347	271	P7410	273	P7475	271	P7540	273	P7609	274
P7348	271	P7411	273	P7476	271	P7541	273	P7610	274
P7349	271	P7412	273	P7477	271	P7542	273	P7611	274
P7350	271	P7413	273	P7478	271	P7543	273	P7612	274
P7351	271	P7414	273	P7479	271	P7544	273	P7613	274
P7352	271	P7415	273	P7480	271	P7545	273	P7614	274
P7353	271	P7416	273	P7481	271	P7546	273	P7615	274
P7354	271	P7417	273	P7482	271	P7547	273	P7616	274
P7355	271	P7418	273	P7483	271	P7548	273	P7617	274
P7356	271	P7419	273	P7484	271	P7549	273	P7618	274
P7357	271	P7420	273	P7485	271	P7550	273	P7628	275
P7358	271	P7421	273	P7486	271	P7551	273	P7629	275
P7359	271	P7422	273	P7487	271	P7552	273	P7630	275
P7360	271	P7423	269	P7488	271	P7553	273	P7631	275
P736030	94	P7424	269	P7489	271	P7554	273	P7632	275
P736034	94	P7425	269	P7490	271	P7555	273	P7633	275
P7361	271	P7426	269	P7491	271	P7556	273	P7634	275
P7362	271	P7427	269	P7492	271	P7557	273	P7635	275
P7363	271	P7428	269	P7493	271	P7558	273	P7636	275
P7364	271	P7429	269	P7494	271	P7559	273	P7637	275
P7365	271	P7430	269	P7495	271	P7560	273	P7638	275
P7366	271	P7431	269	P7496	271	P7561	273	P7639	275
P7367	271	P7432	269	P7497	271	P7562	273	P7640	275
P7368	271	P7433	269	P7498	271	P7563	273	P764008	155
P7369	271	P7434	269	P7499	271	P7565	277	P764010	155
P7370	271	P7435	269	P7500	271	P7566	277	P764012	155
P7371	271	P7436	269	P7501	271	P7567	277	P7641	275
P7372	271	P7437	269	P7502	271	P7568	277	P7642	275
P7373	271	P7438	269	P7503	271	P7569	277	P7643	275
P7374	271	P7439	269	P7504	271	P7570	277	P76430	275
P7375	271	P7440	269	P7505	271	P7571	277	P7646	276
P7376	273	P7441	269	P7506	271	P7572	277	P7647	276
P7377	273	P7442	269	P7507	271	P7573	277	P765020	168
P7378	273	P7443	269	P7508	271	P7574	277	P765024	168
P7379	273	P7444	269	P7509	271	P7575	277	P768006	168
P7380	273	P7445	269	P7510	271	P7576	277	P768008	168
P7381	273	P7446	269	P7511	271	P7577	277	P769008	168
P7382	273	P7447	269	P7512	271	P7578	277	P769010	168
P7383	273	P7448	269	P7513	271	P7579	277	P769018	168
P7384	273	P7449	269	P7514	271	P7580	277	P769020	168
P7385	273	P7450	269	P7515	271	P7581	277	P769022	168
P7386	273	P7451	269	P7516	271	P7582	277	P771025	168
P7387	273	P7452	269	P7517	273	P7583	277	P777540	90
P7388	273	P7453	269	P7518	273	P7584	277	P777548	90
P7389	273	P7454	269	P7519	273	P7585	276	P777560	90
P7390	273	P7455	269	P7520	273	P7586	276	P778040	90
P7391	273	P7456	269	P7521	273	P7587	276	P778048	90
P7392	273	P7457	269	P7522	273	P7588	276	P778060	90
P7393	273	P7458	269	P7523	273	P7589	276	P779017	90
P7394	273	P7459	269	P7524	273	P7590	276	P779021	90
P7395	273	P7460	269	P7525	273	P7591	276	P779026	90
P7396	273	P7461	269	P7526	273	P7592	276	P779060	90
P7397	273	P7462	269	P7527	273	P7593	276	P780006	167
P7398	273	P7463	269	P7528	273	P7594	276	P780008	167
P7399	273	P7464	269	P7529	273	P7595	276	P780010	167
P7400	273	P7465	269	P7530	273	P7596	276	P781006	167
P7401	273	P7466	269	P7531	273	P7597	276	P781008	167
P7402	273	P7467	269	P7532	273	P7598	276	P781010	167
P7403	273	P7468	269	P7533	273	P7599	276	P782008	167
P7404	273	P7469	269	P7534	273	P7603	274	P782010	167
P7405	273	P7470	271	P7535	273	P7604	274	P782012	167

# Numerical index

Índice numérico  
Index numérique

REF.	PAG.	REF.	PAG.	REF.	PAG.	REF.	PAG.	REF.	PAG.
P782014	167	P80330	248	P810014	171	P848008	160	P852030	36
P782016	167	P80340	248	P81010	320	P848014	160	P85220	27
P782018	167	P80350	248	P81020	320	P849000	170	P85221	28
P782020	167	P80360	248	P811004	171	P850000	34	P85222	28
P782022	167	P80374	246	P811006	171	P850001	183	P85223	28
P782024	167	P80380	258	P811008	171	P850002	183	P85230	33
P782026	167	P80390	258	P811010	171	P850003	183	P85231	33
P782028	167	P804000	159	P811012	171	P850004	183	P85232	33
P782075	167	P80430	250	P811014	171	P850005	183	P853004	174
P783006	167	P80440	252	P811016	171	P850006	183	P853006	174
P783008	167	P80460	253	P812003	171	P850007	183	P853008	174
P783010	167	P80470	251	P812005	171	P850012	183	P853010	174
P783012	167	P80480	252	P812007	171	P850017	183	P853012	174
P783014	167	P80500	253	P812009	171	P850018	183	P853014	174
P783016	167	P805000	158	P812011	171	P850022	183	P853030	36
P783018	167	P80510	252	P813016	171	P850023	183	P854006	174
P783020	167	P80520	251	P813020	171	P850024	183	P854008	174
P783022	167	P80540	258	P814000	172	P850025	183	P854010	174
P783024	167	P80550	258	P815006	172	P850026	183	P854012	174
P783026	167	P80560	258	P815009	172	P850027	183	P854014	174
P783028	167	P80570	259	P815012	172	P850028	183	P854016	174
P783030	167	P80580	259	P815015	172	P850031	183	P855000	174
P784020	169	P80590	259	P816011	171	P850033	183	P856000	174
P784025	169	P80610	250	P817005	171	P850101	34	P857000	174
P784030	169	P80620	250	P817006	171	P850102	34	P859101	177
P784035	169	P80630	250	P817008	171	P850104	34	P859102	177
P784040	169	P80641	250	P818000	124	P850124	182	P859103	177
P785006	167	P80670	250	P820000	172	P850128	182	P859104	177
P785008	167	P80680	246	P821000	172	P850222	182	P859105	177
P785010	167	P80700	223	P822000	173	P850424	182	P859106	179
P788025	169	P807000	158	P823000	173	P850426	182	P859107	179
P788050	169	P80710	223	P824000	173	P85050B	29	P859109	177
P789025	169	P80720	223	P830001	162	P85050CP	30	P859110	177
P789050	169	P80730	223	P830002	162	P85050R	29	P859111	177
P796000	166	P80740	258	P830003	162	P85050SS	29	P859113	176
P796100	166	P80750	259	P830004	162	P850528	182	P859114	178
P798040	170	P80760	259	P830005	162	P85090B	29	P859115	176
P798055	170	P80770	259	P833001	95	P85090CP	30	P859116	180
P798056	170	P80780	258	P833002	95	P85090MP	31	P859117	180
P798065	170	P80790	257	P833003	95	P85090MPR	31	P859119	181
P800030	170	P80810	254	P834000	397	P85090MT	31	P859120	181
P800035	170	P80811	254	P835000	397	P85090MTR	31	P859122	178
P800040	170	P80813	254	P836110	160	P85090R	29	P859123	178
P800045	170	P80814	254	P836120	160	P85090SS	29	P859124	178
P800050	170	P80840	253	P836147	160	P851001	30	P859125	178
P800055	170	P80850	253	P836200	160	P851002	30	P859126	178
P800060	170	P80870	253	P836215	160	P851003	30	P859129	180
P800065	170	P80880	253	P837003	161	P851004	35	P859130	178
P800070	170	P80900	245	P837005	161	P851005	35	P859132	176
P801040	159	P80910	256	P837007	161	P851006	35	P859134	176
P801048	159	P80940	249	P839000	158	P851007	35	P859135	176
P802000	159	P80941	249	P840000	158	P851030	36	P859139	176
P80216	426	P80950	255	P842000	158	P851040	170	P859141	176
P80219	426	P80951	255	P845040	159	P851046	170	P859142	176
P80240	246	P80960	248	P845050	159	P851050	170	P859143	176
P80250	246	P80961	248	P845060	159	P85140B	29	P859144	177
P80260	246	P80965	255	P845075	159	P85140CP	30	P859150	177
P80270	246	P80966	255	P845110	159	P85140MP	31	P859151	177
P80280	246	P80970	251	P845138	159	P85140MPR	31	P859152	177
P80282	247	P81000	320	P845155	159	P85140MT	31	P859153	177
P80290	246	P810004	171	P846025	146	P8514			

# Numerical index

Índice numérico  
Index numérique

REF.	PAG.	REF.	PAG.	REF.	PAG.	REF.	PAG.	REF.	PAG.
P859159	178	P876003	471	P904145	423	P909121	92	P914150	152
P859167	178	P880035	505	P904146	423	P90920	489	P915080	154
P859171	178	P880050	505	P904155	418	P909211	92	P916000	154
P859172	178	P881100	505	P904160	423	P909221	92	P916120	154
P859184	178	P882015	505	P904165	423	P90930	490	P917080	154
P859185	178	P882035	505	P904200	423	P909340	92	P919000	220
P859186	179	P882100	505	P904300	397	P909360	92	P919001	220
P859189	179	P885025	504	P904350	418	P909460	92	P919002	220
P859190	179	P885040	504	P904400	423	P909559	162	P919003	220
P859191	179	P885060	504	P904500	423	P910008	314	P920001	221
P859192	179	P886035	504	P904600	420	P911201	141	P920002	221
P859195	179	P887015	504	P904610	421	P911202	141	P920003	221
P859196	179	P887025	504	P904612	421	P911301	141	P921001	221
P859197	179	P887060	504	P904650	421	P911302	141	P922000	221
P859198	179	P887100	504	P904652	421	P911303	141	P922100	221
P859200	180	P890025	503	P904660	420	P911304	141	P923000	221
P859201	180	P890035	503	P904680	421	P911305	141	P923001	221
P859202	181	P890060	503	P904682	421	P911306	141	P924001	221
P859203	181	P891035	503	P904711	420	P911401	141	P924002	221
P859204	181	P891060	503	P904720	419	P911402	141	P924002A	221
P859205	181	P891100	503	P904721	419	P911403	141	P924002R	221
P859206	180	P892015	503	P904725	419	P911404	141	P924002V	221
P859207	180	P892015B	502	P904740	420	P911405	141	P925001	256
P859210	180	P892015N	502	P904760	420	P911406	141	P925002	256
P859211	180	P892015R	502	P904780	420	P911407	142	P926002	478
P859212	180	P892025	503	P904790	417	P911408	141	P926003	478
P859219	178	P892035	503	P904804	418	P911501	142	P926004	478
P859900	184	P892035B	502	P904809	418	P911502	142	P926005	478
P859901	184	P892035N	502	P904810	418	P911503	142	P926006	478
P859902	184	P892035R	502	P904820	418	P911504	142	P926007	478
P859903	184	P892060	503	P904850	418	P911505	142	P926008	478
P859904	184	P892060B	502	P90490	425	P911506	142	P926009	478
P859905	184	P892060N	502	P90492	425	P911507	142	P926010	478
P859907	185	P892060R	502	P90493	425	P911508	142	P926011	478
P859908	185	P892100	503	P904937	421	P911601	142	P926012	478
P859909	185	P892150	503	P904950	421	P911602	142	P926051	478
P859910	185	P892200	503	P904975	421	P911603	142	P926052	478
P859911	185	P893025	503	P904980	421	P911604	142	P926053	478
P861045	222	P893035	503	P904990	421	P911605	142	P926300	464
P861053	222	P894003	506	P905015	119	P911606	142	P926400	464
P862100	482	P894004	506	P905300	416	P911607	142	P926500	464
P863000	482	P894005	506	P905310	417	P911608	142	P926600	464
P867030	380	P895006	507	P905320	417	P911701	141	P927000	439
P867060	380	P895010	507	P905340	417	P911801	141	P928000	439
P867090	380	P895015	507	P905400	416	P911802	141	P928001	439
P867120	380	P895020	507	P905410	416	P911803	141	P929025	94
P868001	122	P896001	506	P905504	415	P911804	141	P929028	94
P868002	122	P896002	506	P905506	415	P911805	141	P929030	94
P868003	122	P896003	505	P905508	415	P911806	141	P929036	94
P868004	122	P896008	505	P905516	415	P911808	141	P929040	94
P868005	122	P897500	430	P905518	416	P911901	142	P937000	135
P868006	122	P898001	507	P907024	439	P911902	142	P938000	138
P868007	122	P898002	507	P907026	439	P911903	142	P940000	124
P868008	122	P899200	435	P908000	152	P911904	142	P940090	124
P868009	122	P899300	435	P908001	152	P911905	142	P940120	124
P870000	119	P900000	223	P908002	152	P911906	142	P941013	100
P871000	119	P901014	142	P908003	152	P911908	142	P941015	100
P872000	114	P901018	142	P908004	152	P912001	141	P941018	100
P872500	160	P902000	449	P90813	427	P913000	142	P941020	100
P873045	124	P903001	433	P908132	427	P913501	142	P941022	100
P873060	124	P903002	433	P90814	427	P913601	142	P941024	100
P873090	124	P904113	423	P908142	427	P913701	142	P941028	100
P874000	482	P904120	423	P90910	489	P913901	142	P942000	119
P876001	471	P904140	423	P90911	489	P914080	152	P943000	119
P876002	471	P904142	423	P909111	92	P914120	152	P944000	124

# Numerical index

Índice numérico  
Index numérique

REF.	PAG.	REF.	PAG.	REF.	PAG.	REF.	PAG.	REF.	PAG.
P945037	118	P964001	138	P994036	84	PC18SN	93	VTB50002	219
P945050	118	P967001	481	P994038	84	PLC-1	513	VTBWR-1	219
P945051	118	P967002	481	P994040	84	PLC-2	513	XMIX0702	302
P946001	123	P967003	481	P994042	84	PLC-3	513	XMIX0703	302
P946002	123	P967004	481	P994046	84	RE8505004	30	XMIX0704	302
P946003	123	P967005	481	P994050	84	RE8509007	30	XMIX0705	302
P946004	123	P967006	481	P994055	84	RE851008	35		
P947302	149	P967007	481	P994065	84	RE8514007	30		
P947303	149	P967008	481	P994080	84	RE937001	135		
P947400	149	P967009	481	P994090	84	RE937002	135		
P947600	149	P968000	35, 482	P995010	84, 458	RE937003	135		
P947700	149	P968130	28	P995016	84, 458	RE940001	124		
P948066	95	P968135	35, 482	P995020	84	RE964100	138		
P948090	95	P969000	482	P995026	84	RE964200	138		
P948132	95	P970000	116	P995030	84	RE975001	131		
P949025	94	P972053	95	P995034	84	RE975002	131		
P949030	94	P972060	95	P995036	84	RE975901	137		
P949035	94	P972201	491	P995038	84	RSCL-4	513		
P949040	94	P972202	491	P995040	84	S1	511		
P950000	318, 432	P972203	491	P995042	84	SAC-SQ5-06	261		
P951010	155	P974000	493	P995050	84	SAVC	261		
P951015	155	P975000	131	P995060	84	SO2-23010.5	298		
P951019	155	P975501	139	P997014	84, 458	SO2-23014.5	298		
P951024	155	P975600	139	P997016	84, 458	T3660	435		
P952001	155	P975900	137	P997028	84	T7206	152		
P952002	155	P976200	492	P997032	84	TR11	230		
P952003	155	P976210	491	P997036	84	TR11G	232		
P953001	155	P976300	492	P997040	84	TR11GG	232		
P953002	155	P979000	160	P998010	458	TR11GGG	232		
P953003	155	P979100	160	P998012	458	TR11GGGG	232		
P953004	155	P979200	160	P998014	458	TR11GGGGG	232		
P953005	155	P980000	148	P998035	85	TR12	231		
P954013	118	P980050	148	P998050	85	TR12H	233		
P954015	118	P980200	147	P998070	85	TR12HH	233		
P954020	118	P981500	148	P999000	85	TR12HHH	233		
P954025	118	P981600	148	P999012	458	TR12HHHH	233		
P955010	100	P981650	148	P999014	458	TR12HHHHH	233		
P955012	100	P983000	500	PC07PCC	93	TR13	231		
P955015	100	P984100	500	PC07SCC	93	TR13M	233		
P955017	100	P984500	500	PC07SHC	93	TR13MM	233		
P955020	100	P985000	500	PC07SN	93	TR13MMM	233		
P956035	501	P988100	495	PC08PCC	93	TR13MMMM	233		
P956040	501	P988200	495	PC08SHC	93	TR18	230		
P956135	501	P988300	495	PC08SN	93	TR18J	232		
P956140	501	P988400	494	PC09SCC	93	TR18JJ	232		
P958010	118	P988500	494	PC09SHC	93	TR18JJJ	232		
P958012	118	P988600	494	PC10PCC	93	TR18JJJJ	232		
P958014	118	P988700	494	PC10SCC	93	TR18JJJJJ	232		
P958016	118	P988900	495	PC10SHC	93	TR21	240		
P958018	118	P990000	495	PC10SN	93	TR22	240		
P959025	156	P99001	213	PC11SHC	93	TR23	240		
P959030	156	P99020	214	PC11SN	93	TR30	240		
P959035	156	P99021	214	PC12PCC	93	TR33	236		
P959040	156	P99030	216	PC12SCC	93	TRA	236		
P959045	156	P99031	216	PC12SN	93	TRG	230		
P959050	156	P992040	168	PC13SHC	93	TRH	231		
P960225	157	P992045	168	PC13SN	93	TRJ	230		
P960230	157	P992050	168	PC14PCC	93	TRM	231		
P960235	157	P994020	84	PC14SHC	93	VCBL100	217		
P962002	432	P994022	84	PC15PCC	93	VCBM100	217		
P962003	432	P994024	84	PC15SCC	93	VDBBM300	219		
P963025	94	P9							



## 1. GOVERNING PROVISIONS

All sales by PUJADAS – A Vollrath Company (“Seller”) are subject to these terms and conditions, and are expressly conditioned upon assent to these terms and conditions. No additional or different terms or conditions will be binding upon Seller unless specifically agreed to in writing. Seller hereby objects to any such additional or different terms, and notifies buyer that Seller is unwilling to sell on any terms other than these terms and conditions. **Each contract of sale, including these terms and conditions shall constitute the entire agreement between Seller and buyer, and shall be governed by, construed and interpreted according to the laws of Spain, without reference to Principles of Conflicts of Laws. The rights and obligations of the Parties hereunder shall not be governed by the 1980 U.N. Convention on Contracts for the International Sale of Goods; and both parties hereby expressly submit to the jurisdiction of the Courts of Barcelona (Spain), in respect of any proceedings arising out of or in connection with the present General Selling Conditions.** There are no conditions affecting the parties’ agreement which are not expressed in these terms and conditions.

## 2. TAXES AND OTHER CHARGES

Any manufacturer's tax, occupation tax, use tax, sales tax, excise tax, value added tax, duty, custom, inspection or testing fee, or any other tax, fee, interest or charge of any nature whatsoever imposed by any governmental authority on or measured by the transaction between Seller and buyer shall be paid by buyer in addition to the prices quoted or invoiced. In the event Seller is required to pay any such taxes or other charges, buyer shall reimburse Seller therefore on demand.

## 3. DELIVERY AND FREIGHT

**All items are delivered FCA point of origin (Incoterms 2020). Except as provided below, orders made from the area of the Peninsula and the Balearic Islands with a value over 500 € (1,600 € in Canary Islands) shipping to one location will be shipped PREPAID by Seller. Orders with a value below 500 € will be assessed a 20 € freight charge. (60 € in Canary Islands). For ultimate destinations outside of Spain, all items are FCA Seller's loading dock (as the latter shipping term is defined in Incoterms 2020).** Delivery of products to the carrier shall constitute delivery to buyer; and regardless of shipping terms or freight payment, buyer shall bear all risk of loss or damage in transit. Seller reserves the right to make delivery in multiple shipments, unless otherwise expressly stipulated herein; all such shipments to be separately invoiced and paid for when due per invoice, without regard to subsequent deliveries.

Seller reserves ownership rights over all the materials supplied until full payment of the same.

### a. Minimum Order Amount and Drop Ship Orders

A 6 € minimum order charge will apply to orders less than One Hundred Euro (100 €) NET. Seller reserves the right to refuse requests to drop ship orders for the same products to one or multiple locations.

### b. Quantity

The materials will be supplied in complete packaging containing the quantity indicated in our rates.

### c. Custom Smallwares

Custom Smallwares orders are completed with over/under shipments, not to exceed plus or minus 10% of the original order quantity.

## 4. CLAIMS, DELAYS AND FORCE MAJEURE

**Under no circumstances shall claims concerning the condition of the merchandise or regarding shipping mistakes be accepted once 15 workdays have elapsed since the reception thereof.**

Claims for shortages or other errors in delivery must be made in writing to Seller within 15 working days after receipt of shipment; and failure to give such notice shall constitute unqualified acceptance and a waiver of all such claims by buyer. **Claims for loss of or damage to goods in transit must be made to the carrier, and not to Seller. OUR RESPONSIBILITY FOR SHIPMENT CEASES WITH ACCEPTANCE BY CARRIERS.**

All delivery dates are approximate. Delay in delivery of any shipment shall not relieve buyer of its obligations to accept remaining shipments. Further, Seller shall not be liable for any losses or damages as a result of any delay or failure to deliver due to any cause beyond Seller's reasonable control, including but not limited to any act of God, act of buyer, arrest or other governmental act, regulation or request, fire, accident, strike, slowdown, war, act of terrorism, riot, delay in transportation, or inability to obtain necessary labor, materials or manufacturing facilities. In the event of any such delay, the date of delivery shall be extended for a period equal to the time lost because of the delay. Buyer's exclusive remedy for other delays and for Seller's inability to deliver for any reason shall be rescission of its agreement to purchase.

## 5. CHANGES

**Seller may at any time make such changes in design and construction of products, components or parts as Seller deems appropriate, without notice to buyer.** Seller may furnish suitable substitutes for materials unobtainable because of priorities or regulations established by governmental authority or non-availability of materials from suppliers.

## 6. WARRANTIES

**Seller warrants any smallwares provided hereunder to be free from nonconformity to any attached specifications, and free of defects in materials and workmanship, appearing within 60 days. Seller also warrants any equipment provided hereunder to be free from nonconformity to any attached specifications, and free of defects in materials and workmanship, appearing within 18 months from date of shipment or 12 months from date of purchase by the end user, whichever ends earlier.** If within such periods any such applicable goods shall be proved to Seller's satisfaction to be defective, the affected part will be repaired or replaced free of charge, FCA buyer's original destination, or Seller will refund the purchase price of the affected part. Such repair, replacement or refund (whichever Seller determines, in its discretion, to provide) shall be Seller's sole obligation and buyer's exclusive remedy for any deficiency in goods furnished hereunder, and shall be conditioned upon buyer's return of such goods to Seller, ., DDP Seller's loading dock (as the latter shipping term is defined in Incoterms 2020). Any parts repaired or replaced under this warranty are warranted only for the balance of the warranty period on the part that was repaired or replaced. Seller gives no warranty on any goods damaged by accident, carelessness, improper installation, lack of proper setup or supervision (when required) or installed or operated in any manner contrary to the installation and operating instructions. Seller gives no warranty on any repair services performed by unauthorized personnel or unauthorized service agencies.

**THE ABOVE WARRANTIES ARE EXCLUSIVE AND IN LIEU OF ALL OTHER REPRESENTATIONS AND WARRANTIES, EXPRESS OR IMPLIED; AND SELLER EXPRESSLY DISCLAIMS AND EXCLUDES ANY IMPLIED WARRANTY OF MERCHANTABILITY OR FITNESS FOR ANY PARTICULAR PURPOSE, AND ANY WARRANTIES ARISING FROM COURSE OF DEALING OR USAGE OF TRADE.**

## 7. CANCELLATIONS AND RETURNS.

No order may be cancelled or altered by buyer except upon terms and conditions acceptable to Seller, as evidenced by Seller's written consent.

Return Authorizations must be requested for all returns. Product returned without prior authorization from Seller's Santa Coloma de Farners office **WILL BE REFUSED.** PUJADAS if free to authorize the return and can decide refuse the return by its free criterion.

a. Requests for returns of merchandise (other than defective merchandise) must be made within **90 DAYS of the PUJADAS INVOICE DATE. PURCHASE ORDER NUMBER or PUJADAS INVOICE NUMBER MUST BE PROVIDED when requesting the authorization. NO RETURN AUTHORIZATION will be issued unless Purchase Order Number or PUJADAS Invoice Number is provided.**

b. **A restocking charge applies as follows:**

1. Merchandise less than 50 € value – 10 € restocking charge.  
2. **Merchandise more than 50 € value - 20% restocking charge.**

c. The returns or shipments of materials to the facilities of PUJADAS whether for payment, replacement or repair should always be made **by prepaid freight.**

d. Return Authorization Number must be marked on all returned cartons.

e. **Returns accepted only on current merchandise found in original carton and in new and saleable condition. Merchandise returned that is used, obsolete or shelf-worn will be disposed of and credit WILL NOT be issued.**

1. The return of SHELIVING shall only be performed in complete & original packaging, on pallets if it is more than one packaging and properly protected.

2. The return of TROLLEYS shall be made on pallets and with complete protective packaging.

f. The following items may not be returned: (1) custom smallware, (2) Traex dishwasher racks, (3) personalized items.

Neither shall the return of materials be admitted in which PUJADAS has performed some specific adaptation to comply with the order.

## 8. PATENTS, TRADEMARKS AND COPYRIGHTS

Seller will, at its own expense, defend any suits that may be instituted by anyone against buyer for alleged infringement of any European Union patent, trademark or copyright relating to goods or services provided by Seller, and pay any final damage award therein, provided buyer shall have made all payments then due hereunder, shall give Seller immediate notice in writing of any such suit, shall transmit to Seller immediately upon receipt all processes and papers served upon buyer, and shall permit Seller, through its counsel, to defend or settle the same either in the name of buyer or in the name of Seller, giving Seller all needed information, assistance and authority to enable Seller to do so. Further, if the result of any such suit is a determination or acknowledgement of infringement, Seller shall, at Seller's option (a) obtain for buyer the right to continue to use the goods or products of the services purchased from Seller, or (b) replace the same with non-infringing goods or services, or (c) modify such goods or services so that they are non-infringing, or (d) remove such goods or products of services and refund to buyer the undepreciated portion of the purchase price, determined on the basis of a five-year useful life.

To the extent that any goods or services that Seller furnishes to buyer are manufactured in accordance with drawings, designs or specifications proposed or furnished by buyer, Seller shall not be liable, and buyer shall indemnify and hold harmless Seller from and against any and all losses, liabilities, damages, claims and expenses (including but not limited to Seller's reasonable attorneys' fees and other costs of defense) incurred by Seller as a result of any claim of patent, trademark, copyright or trade secret infringement, or infringement or any other proprietary rights of third parties.

## 9. CONSEQUENTIAL DAMAGES AND OTHER LIABILITY; INDEMNITY

Seller's liability with respect to the goods or services sold hereunder shall be limited to the warranty and indemnity provided in sections 7 and 9 of these terms and conditions of sale and, with respect to any other breaches of its contract with buyer, shall be limited to the contract price. **SELLER SHALL NOT BE SUBJECT TO ANY OTHER OBLIGATIONS OR LIABILITIES, WHETHER ARISING OUT OF BREACH OF CONTRACT, WARRANTY, TORT (INCLUDING NEGLIGENCE AND STRICT LIABILITY) OR UNDER OTHER THEORIES OF LAW OR EQUITY, WITH RESPECT TO GOODS OR SERVICES SOLD BY SELLER, OR ANY UNDERTAKINGS, ACTS OR OMISSIONS RELATING THERETO.** Without limiting the generality of the foregoing, Seller specifically disclaims any liability for property damages, penalties, special or punitive damages, damages for lost profits or revenues, down-time, lost good will, cost of capital, cost of substitute goods or services, or for any other types of loss of economic advantage, or for claims of buyer's customers or any third party for any such damages, costs or losses.

**SELLER SHALL NOT BE LIABLE FOR AND DISCLAIMS ALL CONSEQUENTIAL, INCIDENTAL, INDIRECT AND CONTINGENT DAMAGES WHATSOEVER.**

Buyer shall indemnify and hold harmless Seller from and against any and all losses, liabilities, damages and expenses (including but not limited to attorneys' fees and other costs of defense) that Seller may incur as a result of any claim by buyer or by buyer's customers or by any third party arising out of or in connection with the goods or services sold hereunder, , unless such losses, liabilities, damages or expenses are ultimately determined to be attributable solely to the willful misconduct of Seller.

## 10. PRICES

The selling prices are those specified in our rates, in reference to the merchandise in our warehouse of Santa Coloma de Farners with non-returnable cardboard packaging.

## 11. PHOTOS, DATA AND MEASUREMENTS

The photos, **data and measurements in the Seller's catalogue are subject to change**, without prior notice, due to technical or production requirements.

## 12. PERSONAL DATA PROTECTION

In accordance with the provisions of current legislation on the Protection of Personal Data, VOLLRATH PUJADAS, S.A.U informs the buyer that the personal data collected during the commercial relationship will be processed and incorporated into the seller's files, with the aim of being able to provide the services requested, as well as to keep the buyer informed of new products and services. The data provided will be kept as long as the commercial relationship is maintained and, once it has ended, to meet those requests required under tax legislation. The buyer may, at any time, exercise the rights of access, rectification or erasure, restriction of processing, data portability and opposition by means of a written request to info@pujadas.es, accompanied by a photocopy of your DNI/NIF (National Identity Document/Tax Identification Number). You can also contact the competent Control Authority to submit any complaint that you consider appropriate.

**All rights reserved to make changes, without prior notice to articles that appear in this catalogue, particularly in relation to colours and/or prices.**

Photographs do not form part of the contract.

## 1. DISPOSICIONES LEGALES

Todas las ventas realizadas por PUJADAS – Una compañía del grupo Vollrath (en adelante, “el vendedor”) están sujetas a los presentes términos y condiciones, y están expresamente condicionadas por la aceptación de los presentes términos y condiciones. Ningún otro término o condición adicional o diferente será vinculante para el vendedor a menos que se acuerde lo contrario específicamente por escrito. Por el presente el vendedor no acepta otros términos adicionales o diferentes y notifica al comprador que no está dispuesto a vender en virtud de términos diferentes de los presentes términos y condiciones. **Cada contrato de venta, incluyendo los presentes términos y condiciones, constituirá el acuerdo indivisible entre el vendedor y el comprador, y se regirá, interpretará y entenderá según las leyes de España, sin remisión a los Principios sobre Conflictos de Leyes. Los derechos y las obligaciones de las partes en virtud del presente no se regirán por la Convención de las Naciones Unidas sobre los Contratos de Compraventa Internacional de Mercaderías de 1980; y por el presente ambas partes se someten expresamente a la jurisdicción de los tribunales de Barcelona (España), para cualquier proceso judicial que surja de las presentes condiciones generales de venta o relacionado con estas.** No existe ninguna condición que afecte al acuerdo de las partes que no esté expresada en los presentes términos y condiciones.

## 2. IMPUESTOS Y OTROS CARGOS

Los impuestos del fabricante, impuesto por ocupación, impuesto por el uso, impuesto sobre las ventas, impuesto sobre consumos específicos, impuesto sobre el valor añadido, tasas, tarifas de personalización, inspección o prueba, o cualquier otro impuesto, tasa, interés o cargo de cualquier naturaleza impuesto por una autoridad gubernamental, en virtud de la transacción entre el comprador y el vendedor serán pagados por el comprador, además de los precios cotizados o facturados. Si el vendedor debiera pagar dichos impuestos u otros cargos, el comprador deberá reembolsarlos al vendedor.

## 3. ENTREGA Y FLETE

**Todos los productos se entregarán bajo FCA punto de origen (Incoterms 2020). Con la excepción de lo establecido a continuación, los pedidos realizados desde la zona de la Península Ibérica y las Islas Baleares con un valor superior a 500 € (1.600 € en las Islas Canarias) con envío a un único destino se enviarán PREPAGADOS por el vendedor. Los pedidos con un valor inferior a 500 € (Base Imponible) se grabarán con un cargo por flete de 20 € (60 € en las Islas Canarias). Para destinos finales fuera de España, todos los productos estarán sujetos a FCA muelle de carga del vendedor (según la definición de este último en Incoterms 2020).** La entrega de los productos al transportista se considerará entrega al comprador; e independientemente de los términos de envío o el pago del flete, el comprador asumirá todos los riesgos por pérdida o daño durante el transporte. El vendedor se reserva el derecho a hacer la entrega en múltiples envíos, a menos que se estipule lo contrario expresamente en el presente; dichos envíos se facturarán por separado y se pagarán en la fecha que indica cada factura, independientemente de las entregas posteriores. El vendedor se reserva los derechos de propiedad de todos los materiales enviados hasta el pago completo de estos.

### a. Gestión por pedido mínimo

Se aplicará un cargo de 6 € por la gestión de pedidos inferiores a 100 € NETOS. El vendedor se reserva el derecho a no aceptar pedidos de envío directo para los mismos productos a uno o múltiples sitios.

### b. Cantidad

Los materiales se enviarán con el embalaje completo que contenga la cantidad indicada en nuestras tarifas.

### c. Utensilios de cocina a medida

Los pedidos de utensilios de cocina a medida se ejecutan con entregas parciales/sobreenvíos, sin que la diferencia suponga un 10% más o menos de la cantidad original pedida.

### d. Para pedidos Urgentes para todo territorio nacional, incluyendo islas Baleares y Canarias, se les aplicará un cargo de 15€ por pedido.

El envío será por “Transporte Ugente” con compromiso de entrega en 24 horas, a excepción de las Islas Canarias y Baleares. En estos casos, el transporte será a cargo del cliente.

## 4. RECLAMACIONES, RETRASOS Y FUERZA MAYOR

**No se aceptarán bajo ninguna circunstancia reclamaciones relativas al estado de la mercancía o a errores de envío tras 15 días laborables desde la recepción de esta.**

Las reclamaciones por falta de materiales u otros errores en la entrega deben efectuarse por escrito ante el vendedor en el plazo de 15 días laborables tras la recepción del envío; y el hecho de no notificar dicha reclamación supone la aceptación absoluta y la renuncia a cualquier reclamación por parte del comprador. **Las reclamaciones por pérdidas o daños en los productos durante el transporte deben efectuarse ante el transportista y no ante el vendedor. NUESTRA RESPONSABILIDAD POR EL ENVÍO FINALIZA CON LA ACEPTACIÓN DE ESTE POR PARTE DE LOS TRANSPORTISTAS.**

Todas las fechas de entrega son aproximadas. El retraso en la entrega de cualquier envío no exime al comprador de su obligación de aceptar los envíos restantes. Además, el vendedor no será responsable por las pérdidas o los daños que resulten de los retrasos o de la falta de entrega por cualquier causa fuera del control razonable del vendedor, incluyendo sin limitación fuerza mayor, actos del comprador, embargo u otro acto, norma o petición gubernamental, incendio, accidente, huelga, parones, guerra, acto de terrorismo, disturbios, retraso en el transporte o incapacidad para conseguir la mano de obra, los materiales o las instalaciones de producción necesarios. En caso de algún retraso de este tipo, la fecha de entrega se ampliará durante un plazo igual al tiempo perdido debido al retraso. El único remedio del comprador por otros retrasos y por la incapacidad del vendedor de efectuar la entrega por cualquier motivo será la rescisión de su contrato de compra.

## 5. MODIFICACIONES

**En cualquier momento, el vendedor podrá realizar modificaciones en el diseño y la construcción de los productos, los componentes o las partes como el vendedor lo crea apropiado, sin previo aviso al comprador.** El vendedor puede ofrecer sustitutos apropiados del material no disponible debido a las prioridades o normas establecidas por la autoridad gubernamental o la falta de materiales por parte de los proveedores.

## 6. GARANTÍA

El vendedor garantiza que cualquier utensilio de cocina suministrado en virtud del presente está libre de disconformidad con cualquier especificación adjunta y libre de defectos en los materiales y la calidad, que aparezcan en el plazo de 60 días. El vendedor también garantiza que cualquier equipo suministrado en virtud del presente está libre de disconformidad con cualquier especificación adjunta y libre de defectos en los materiales y la calidad, que aparezcan en el plazo de 18 meses desde la fecha de envío o 12 meses desde la fecha de compra por el usuario final, lo que ocurra antes. Si en dichos plazos cualquier producto pertinente se demuestra a satisfacción del vendedor que es defectuoso, la pieza afectada será reparada o sustituida sin cargo, bajo FCA destino original del comprador, o el vendedor devolverá el precio de compra de la parte afectada. La reparación, la sustitución o la devolución (lo que el vendedor determine, a su discreción) constituirá la única obligación del vendedor y el único remedio del comprador para cualquier deficiencia en los productos suministrados en virtud del presente, y estará condicionada por la devolución de dichos productos al vendedor por parte del comprador, bajo DDP muelle de carga del vendedor (según la definición de este último en Incoterms 2020). Cualquier pieza reparada o sustituida en virtud de esta garantía se garantiza solo durante el período restante de garantía sobre la pieza que ha sido reparada o sustituida. El vendedor no garantiza productos que hayan sido dañados por accidente, imprudencia, instalación indebida, configuración o supervisión (cuando proceda) inadecuadas o que hayan sido instalados o puestos en funcionamiento de cualquier modo que sea contrario a las instrucciones de instalación y funcionamiento. El vendedor no garantiza ningún servicio de reparación efectuado por personal no autorizado o agencias de servicios no autorizadas.

**LAS GARANTÍAS ANTERIORES SON EXCLUSIVAS Y SUSTITUYEN TODAS LAS OTRAS ASEVERACIONES Y GARANTÍAS, EXPRESAS O IMPLÍCITAS; Y EL VENDEDOR NO ACEPTA Y EXCLUYE EXPRESAMENTE CUALQUIER GARANTÍA IMPLÍCITA DE COMERCIALIZACIÓN O IDONEIDAD PARA CUALQUIER PROPÓSITO PARTICULAR, Y CUALQUIER GARANTÍA QUE PUEDA SURGIR DE UN ACUERDO O USO COMERCIAL.**

## 7. CANCELACIONES Y DEVOLUCIONES

Ningún pedido podrá ser cancelado ni modificado por el comprador excepto en virtud de los términos y condiciones que pueda aceptar el vendedor, tal como lo indique el consentimiento escrito del vendedor.

Se solicitará una autorización de devolución para todas las devoluciones. **SE RECHAZARÁN** las devoluciones de productos que no cuenten con la autorización previa por parte de la oficina del vendedor de Santa Coloma de Farners.

PUJADAS tiene libertad para autorizar y devolver y puede decidir rechazar la devolución según su propio criterio.

**a.** Las solicitudes de devoluciones de mercancía (que no sea mercancía defectuosa) deben efectuarse en el plazo de **90 DÍAS desde la FECHA DE LA FACTURA DE PUJADAS. DEBE INDICARSE EL NÚMERO DE ORDEN DE COMPRA o EL NÚMERO DE FACTURA DE PUJADAS al solicitar la autorización. NO SE EMITIRÁ NINGUNA AUTORIZACIÓN DE DEVOLUCIÓN a menos que se proporcione el número de orden de compra o el número de factura de Pujadas.**

**b.** Se aplicará un cargo por reposición de existencias como se indica a continuación: **Para cualquier devolución se cargará un 20% del importe, por demérito y gestión, con un mínimo de 10 €.**

**c.** Las devoluciones o los envíos de materiales a las instalaciones de PUJADAS para su pago, sustitución o reparación deberán efectuarse **siempre por flete prepagado.**

**d.** El número de autorización de la devolución deberá marcarse en todos los embalajes de los productos que se devuelvan.

**e.** Únicamente se aceptarán devoluciones de mercancía actual en su embalaje original, sin usar y en estado vendible. **La mercancía devuelta que haya sido usada, esté obsoleta o desgastada se eliminará y NO se emitirá crédito.**

**1.** La devolución de ESTANTERÍAS solo se efectuará si van en su embalaje completo y original, en palés si constan de más de un bulto y correctamente protegidas.

**2.** La devolución de CARROS se efectuará en palés y con el embalaje protector completo.

**f.** Los siguientes productos no pueden devolverse: (1) utensilios de cocina a medida, (2) cestas de lavado Traex (3) artículos personalizados.

Tampoco se aceptará la devolución de materiales en los que PUJADAS haya efectuado alguna adaptación concreta para satisfacer el pedido.

## 8. PATENTES, MARCAS COMERCIALES Y COPYRIGHT

El vendedor, únicamente a su cargo, se defenderá de cualquier demanda realizada por cualquier persona contra el comprador por presunta violación de una patente de la Unión Europea, marca comercial o copyright relacionada con los productos o servicios ofrecidos por el vendedor en virtud del presente, y pagará cualquier indemnización por daños que se otorgue en firme, siempre y cuando el comprador haya realizado todos los pagos en virtud del presente y notifique por escrito al vendedor dicha demanda de inmediato, y transmita de inmediato al vendedor todas las notificaciones procesales y documentos recibidos, y permita al vendedor, a través de su abogado, defenderse de esta o resolverla, ya sea en nombre del comprador o del vendedor, y suministre toda la información, asistencia y autoridad necesarias para permitir al vendedor que así lo haga. Además, si el resultado de cualquier demanda es una resolución o un reconocimiento de infracción, el vendedor deberá, a elección del vendedor: (a) obtener para el comprador el derecho de continuar usando los bienes o productos o los servicios adquiridos del comprador, (b) sustituirlos con productos o servicios que no supongan ninguna infracción, (c), modificar dichos productos o servicios de manera que no supongan ninguna infracción, o (d) eliminar dichos bienes o productos o servicios y reembolsar al comprador la parte no devaluada del precio de compra, considerando una vida útil de cinco años.

En cuanto a los productos o servicios que el vendedor suministra al comprador fabricados partiendo de dibujos, diseños o especificaciones propuestas o suministradas por el comprador, el vendedor no será responsable y el comprador deberá indemnizar y eximir de responsabilidad al vendedor ante cualquier pérdida, responsabilidad, daño, reclamación y gasto (incluyendo sin limitación los honorarios razonables de los abogados del vendedor y otros costes de defensa) incurridos por el vendedor como resultado de una demanda por patente, marca comercial, copyright o violación del secreto comercial, o violación de otro derecho sobre la propiedad de terceros.

## 9. PERJUICIOS Y OTRA RESPONSABILIDAD; INDEMNIZACIÓN

La responsabilidad del vendedor respecto de los productos o servicios que se vendan en virtud del presente se limitará a la garantía y la indemnización establecidas en las secciones 7 y 9 de los presentes términos y condiciones de venta y, respecto de cualquier otro incumplimiento de su contrato con el comprador, se limitará al precio del contrato. **EL VENDEDOR NO ESTARÁ SUJETO A OTRA OBLIGACIÓN O RESPONSABILIDADES, YA SEA QUE SURJAN DE UN INCUMPLIMIENTO DE CONTRATO, GARANTÍA, ILÍCITO CIVIL (INCLUYENDO NEGLIGENCIA Y RESPONSABILIDAD POR HECHOS AJENOS) U OTRAS DOCTRINAS, RESPECTO DE LOS PRODUCTOS O LOS SERVICIOS OFRECIDOS POR EL VENDEDOR, O CUALQUIER EMPRENDIMIENTO, ACCIÓN U OMISIÓN RELACIONADA CON ESTOS.** Sin limitar el carácter general de lo antedicho, el vendedor específicamente rechaza cualquier responsabilidad por daños a la propiedad, multas, daños cuantificables o punitivos, daños por lucro cesante, inactividad, pérdida de clientela, coste de capital, coste de sustitución de productos o servicios, o cualquier otro tipo de pérdida de ventaja económica, o demandas de los clientes del comprador o de cualquier tercero por dichos daños, costes o pérdidas.

**EL VENDEDOR NO SERÁ RESPONSABLE Y NO ACEPTA LA RESPONSABILIDAD POR PERJUICIOS, DAÑOS FORTUITOS, INDIRECTOS Y ACCIDENTALES DE CUALQUIER NATURALEZA.**

El comprador eximirá y liberará al vendedor de cualquier pérdida, responsabilidad, daños y gastos (incluyendo sin limitación honorarios razonables de abogados y otros costes de defensa) en que pueda incurrir el vendedor como resultado de cualquier demanda del comprador, de los clientes del comprador o de cualquier tercero derivados de los productos y servicios que se vendan en virtud del presente o relacionados con estos, a menos que se determine en última instancia que dichas pérdidas, responsabilidades, daños o gastos son atribuibles únicamente a la conducta premeditada del vendedor.

## 10. PRECIOS

Los precios de venta son los que se especifican en nuestras tarifas, en referencia a la mercancía de nuestro almacén de Santa Coloma de Farners con embalaje de cartón no retornable.

## 11. FOTOGRAFÍAS, INFORMACIÓN Y MEDIDAS

Las fotografías, la información y las medidas indicadas en el catálogo del vendedor pueden sufrir cambios, sin previo aviso, debido a requisitos técnicos o de producción.

## 12. PROTECCIÓN DE DATOS PERSONALES

De conformidad con lo establecido en la normativa vigente en materia de protección de datos de carácter personal, VOLLRATH PUJADAS, S.A.U informa al comprador que los datos personales recogidos durante la relación comercial serán tratados e incorporados en los ficheros del vendedor, con el objetivo de poder prestar los servicios solicitados, así como también para mantenerlo informado de nuevos productos y servicios. Los datos facilitados se conservarán mientras se mantenga la relación comercial y una vez finalizada se conversarán aquellos que vengan exigidos por la legislación tributaria. En cualquier momento usted podrá ejercer los derechos de acceso, rectificación o supresión, limitación del tratamiento, portabilidad y oposición mediante una petición escrita a [info@pujadas.es](mailto:info@pujadas.es), acompañada de una fotocopia de su DNI/NIF. También podrá dirigirse a la Autoridad de Control competente para presentar la reclamación que considere oportuna.

**Quedan reservados todos los derechos de cambio sin aviso previo, en especial colores o precios para los artículos que aparecen en este catálogo.**

Fotografías no contractuales.

# Conditions generales de vente

# français

## 1. DISPOSITIONS APPLICABLES.

Toutes les ventes réalisées par PUJADAS – A Vollrath Company (“Le Vendeur”) sont soumises à ces termes et conditions générales, et sont expressément conditionnées à l’acceptation de ces termes et conditions générales. Aucune modalité ou conditions générales différentes ou supplémentaires ne s’imposeront au Vendeur, sauf accord stipulé par écrit. Le vendeur s’oppose à l’ajout de modalités et de conditions différentes et informe l’acheteur que le Vendeur n’est pas disposé à vendre ses produits sous tout autre terme que ces termes et conditions. **Chaque contrat de vente, incluant ces termes et conditions constituera l’accord intégrale entre le Vendeur et l’acheteur, et sera régi par, et interprété conformément aux lois espagnoles, sans égard à aucun principe de conflit de lois. Les droits et obligations des Parties au contrat ne seront pas régis par la Convention 1980 des Nations Unies sur les Contrats de Vente Internationale de marchandise ; et les deux parties au contrat se soumettent expressément à la juridiction des tribunaux de Barcelone (Espagne) pour toute procédure découlant ou en relation avec les présentes conditions générales de vente.** Il n’y a pas de conditions affectant l’accord entre les deux parties au contrat qui ne sont pas exprimés dans ces termes et conditions.

## 2. TAXES AND AUTRES FRAIS

Toute taxe de fabricant, taxe d’occupation, taxe d’utilisation, taxe de vente, taxe d’accise, taxe sur la valeur ajoutée, droit de douane, taxe d’inspection ou d’examen, ou toute autre taxe, frais, intérêts ou frais de quelque nature que ce soit imposés par une autorité gouvernementale ou mesures pour la transaction entre le Vendeur et l’acheteur doit être payé par l’acheteur en plus du prix estimé ou facturé. Dans l’éventualité où le Vendeur serait tenu de payer de telles taxes ou autres frais, l’Acheteur devra les lui rembourser sur demande.

## 3. LIVRAISON ET FRET

**Tous les articles sont livrés FCA point d’origine (Incoterms 2020). A l’exception des dispositions ci-dessous, les commandes effectuées depuis la péninsule et depuis les Iles Baléares avec une valeur supérieure à 500 € (1,400 € pour les îles Canaries) pour d’expéditions à un unique destin seront expédiées PREPAID (PRÉPAYÉ) par le Vendeur. Les commandes d’une valeur inférieure à 500€ seront évaluées de frais de fret de 20€. (60€ aux Iles Canaries) Pour les commandes dont la destination finale est en dehors d’Espagne, les produits sont livrés FCA dock de chargement du Vendeur (ceci étant défini par les conditions d’expédition des Incoterms 2020).** La livraison des produits au transporteur constituera la livraison à l’acheteur ; ce qui signifie qu’indépendamment des conditions d’expédition ou de paiement du fret, l’acheteur doit supporter tous les risques de perte ou de détérioration liés au transport. Le Vendeur se réserve le droit de procéder à la livraison en plusieurs envois, sauf si le contraire est expressément stipulé ci-inclus. Tous les envois multiples devront être facturés et payés séparément au moment de la facturation, sans tenir compte des livraisons ultérieures.

Le Vendeur se réserve le droit de propriété sur tous les produits fournis jusqu’au paiement complet de ces derniers.

### a. Montant minimum de la commande et commandes Drop Ship

Des frais minimums de 6 € seront appliqués aux commandes inférieures à 100 € NET.

Le Vendeur se réserve le droit de refuser des demandes de dropshipping pour les mêmes produits à destination d’une ou plusieurs localités.

### b. Quantité

Les matériaux seront fournis dans un emballage complet contenant la quantité indiqué dans nos tarifs.

### c. Ustensiles personnalisés

Les commandes d’ustensiles personnalisés sont complétées avec des envois inférieurs ou supérieurs, ne dépassant pas plus ou moins 10% de la comande originale.

## 4. RÉCLAMATIONS, RETARDS ET FORCE MAJEURE

**En aucun cas, les réclamations concernant l’état de la marchandise ou des erreurs de livraison ne seront acceptées une fois que 15 jours ouvrables se sont écoulés depuis leur réception.**

Les réclamations pour manque de produits ou tout autre erreur de livraison doivent être faites par écrit au Vendeur dans les 15 jours ouvrables suivant la réception de la marchandise. L’omission de donner un tel avis constituerai une acceptation sans réserve et une renonciation à toute réclamation ultérieure de l’acheteur. **Les réclamations pour perte ou détériorations sont à effectuer auprès du transporteur et non de l’acheteur. NOTRE RESPONSABILITÉ QUAND AU TRANSPORT CESSE APRÈS ACCEPTATION DU TRANSPORTEUR.**

Toutes les dates de livraison sont approximatives. Le retard d’une livraison ne libère pas l’acheteur de son obligation d’accepter les envois restants. En outre, Le Vendeur ne serait pas être tenu responsable des pertes ou des dégradations résultant d’un retard ou d’un défaut de livraison en raison de circonstances ou d’évènements indépendants de la volonté du Vendeur, incluant sans s’y limiter tout acte de Dieu, d’actes émanant de l’acheteur, d’actes gouvernementaux, de règlements ou demandes, feu, accident, grève, ralentissement, guerre, acte de terrorisme, émeute, retard dans le transport, incapacité d’un travailleur, défaillance du matériel ou des installations du fabriquant. En cas de retard, la date de livraison est prolongée pour une période égale au temps perdu en raison du retard. Le recours exclusif de l’acheteur pour d’autres retard et pour l’incapacité du Vendeur à livrer la marchandise peut être l’annulation du contrat d’achat.

## 5. MODIFICATIONS

**Le Vendeur peut à tout moment effectuer des changements concernant la conception ou la construction des produits, des composants ou de pièces si le Vendeur les juge appropriés, sans le notifier à l’Acheteur.** Le Vendeur peut fournir des substituts appropriés pour les matériaux impossibles de se procurer à cause de priorités ou de règlements imposés par une autorité gouvernementale ou en cas de non disponibilités des matériaux auprès des fournisseurs.

## 6. GARANTIES

**Le vendeur garantit que tous les produits fournis en vertu des présentes CGV sont exempts de non-conformité aux spécifications ci-jointes, et sans défauts de fabrications apparaissant dans les 60 jours. Le vendeur garantit également que tous les équipements fournis en vertu des présentes CGV sont exempts de non-conformité aux spécifications ci-jointes, et sans défauts de fabrications apparaissant dans les 18 mois suivant le date d’envoi ou dans les 12 mois suivant la date d’achat de l’utilisateur final, qui se termine plus tôt.** Si au cours de ces périodes il était prouvé au Vendeur que les produits sont défectueux, la part correspondante serait remplacée gratuitement, FCA destination initiale de l’acheteur, ou le Vendeur rembourserait le prix d’achat de la part affectée. Une telle réparation, remplacement ou remboursement (que le Vendeur détermine et accepte à son gré) représente l’unique obligation du Vendeur et le recours exclusif de l’acheteur pour de tels défaut pour des produits fournis dans le cadre de ces conditions générales de vente, et est conditionné au retour des produits par l’acheteur au Vendeur, DDP au dock d’expédition du Vendeur (ceci étant défini par les conditions d’expédition des Incoterms 2020). Toute pièce réparé ou remplacé dans le cadre de cette garantie est garantie seulement sur le solde de la période de garantie de la pièce réparée ou remplacée. Le vendeur ne garantit aucun produit endommagé par accident, négligence, mauvaise installation, manque de maintenance (le cas échéant) ou installation ou utilisation contraires aux instructions d’installation et d’utilisation. Le vendeur n’offre aucune garantie sur les services de réparation effectués par du personnel non autorisé ou des agences non autorisées.

**LES GARANTIES CI-DESSUS SONT EXCLUSIVES ET EN LIEU ET PLACE DE TOUTES AUTRES REPRESENTATIONS OU GARANTIES, EXPRESSES OU IMPLICITES, ET LE VENDEUR DECLINE ET EXCLUT TOUTE GARANTIE IMPLICITE DE QUALITE MARCHANDE OU D’ADAPTATION A UN USAGE PARTICULIER, ET TOUTE GARANTIE POUVANT DECOULER DE RAPPORTS D’AFFAIRES OU DE PRATIQUES COMMERCIALES.**

# français

## 7. RÉSILIATIONS ET RENVOIS

Ningún pedido podrá ser cancelado ni modificado por el comprador. Aucune commande ne saurait être annulée ou modifiée par l’acheteur excepté dans le cadre des termes et conditions acceptables pour le Vendeur, et avec le consentement écrit de ce dernier.

Des Autorisations de Renvoi doivent être sollicitées pour tout renvoi.

Les produits renvoyer sans autorisation préalable de la part des bureaux du Vendeur à Santa Coloma de Farners **SERONT REFUSÉS.** PUJADAS est libre d’autoriser le renvoi et peut décider de refuser le renvoi sur critères propres.

**a. Les demande de renvoi de marchandise (pour un motif autre que produits défectueux) doivent être faites dans les 90 JOURS suivant la DATE DE FACTURATION par PUJADAS. LE NUMÉRO DE COMANDE ou LE NUMÉRO DE LA FACTURE DOIT ÊTRE FOURNI pour une demande d’autorisation. AUCUNE AUTORISATION DE RENVOI ne sera émise si le numéro de commande ou le numéro de facture n’est pas fourni.**

**b. Des frais de restockage s’appliquent de la façon suivante :**

1. Marchandise d’une valeur inférieure à 50€– 10 € de frais de restockage.

2. Marchandise d’une valeur supérieure à 50 € - 20% comme frais de restockage.

**c. Les renvois ou les envois de produit à destination des installations de PUJADAS pour des raisons de paiement, de remplacement ou de réparation devraient toujours être effectués en fret payé d’avance.**

**d. Le Numéro de l’Autorisation de Retour doit être indiqué sur tous les cartons retournés.**

**e. Les renvois sont acceptés uniquement pour les produits actuels, trouvés dans leurs cartons d’origine, à l’état de neuf et pouvant être revendu. Les produits renvoyer, s’ils sont usés, obsolètes ou présentent des marques de manipulation seront élimés et le crédit NE SERA PAS émis.**

1. Le renvoi de RAYONNAGE devra uniquement être effectué dans son emballage complet et original, sur palette s’il s’agit de plus d’un emballage, et parfaitement protégé.

2. Le renvoi de CHARIOTS doit être effectué sur palette et avec l’emballage de protection complet.

**f. Les produits suivants ne peuvent pas être renvoyé :** (1) Les ustensiles personnalisés, (2) casiers à vaisselle Traex, (3) produits personnalisés.

Le renvoi de produits pour lesquels PUJADAS a dû faire des adaptations pour honorer une demande, ne se pas accepté non plus.

## 8. BREVETS, MARQUE DÉPOSÉE ET COPYRIGHTS

Le vendeur défendra, à ses frais, tout procès qui pourrait être engagé par un tiers contre l’Acheteur pour la présumée violation d’un brevet, d’une marque déposée ou d’un copyright de l’Union Européenne en relation avec des produits ou des services fournis par le Vendeur, et il paiera toute indemnité finale en cas de dommage et intérêts, à condition que l’Acheteur ait effectué tous les paiement dus, l’acheteur devra immédiatement informer par écrit le Vendeur d’une telle poursuite, il devra de façon immédiate transmettre au Vendeur et dès leur réception les procédures et les documents qui sont notifiés à l’acheteur et devra permettre au Vendeur, via son avocat, de défendre ou régler cette affaire soit au nom de l’acheteur soit au nom du Vendeur, en donnant au Vendeur toutes les informations nécessaires, l’assistance et l’autorité pour lui permettre de le faire. En outre si le résultat d’un tel procès est une condamnation ou la reconnaissance d’une infraction, le Vendeur devra, à l’option du Vendeur (a) obtenir pour l’acheteur le droit de continuer à faire usage des produits ou des services achetés au Vendeur ou (b) remplacer ces derniers par des produits ou des services non litigieux, ou (c) modifier ces produits ou ces services de façon à ce qu’ils ne soient plus litigieux, ou (d) retirer ces produits ou services et rembourser à l’acheteur une valeur inférieure au prix d’achat déterminé en se basant sur une durée de vie utile de 5 ans.

Dans la mesure où tous les produits ou services fournis à l’acheteur par le Vendeur sont fabriqués conformément aux dessins, aux plans ou aux spécificités proposés ou fournis par l’acheteur, le Vendeur ne sera pas responsable, et l’acheteur devra indemniser et décharger le Vendeur pour et contre toute sorte de perte, d’en-cours, de dommages et intérêts, de réclamations et de dépenses (notamment, mais sans s’y limiter les honoraires engagés par le Vendeur pour sa défense et les autres coûts liés à sa défense) engagés par le Vendeur à la suite d’une réclamation pour atteinte au brevet, à la marque déposée, au copyright ou a une atteinte au secret commercial, ou pour tout autre violation du droit de propriété d’un tiers.

# Conditions generales de vente

## 9. DOMMAGES CONSÉCUTIFS ET AUTRES RESPONSABILITÉS ; INDEMNITÉ

La responsabilité du vendeur à l’égard des produits et des services vendus en vertu des conditions présentes est limitée aux garanties et aux indemnités prévues aux articles 7 et 9 des présentes conditions générales de vente et, en ce qui concerne tout autre manquement au contrat qu’il a avec l’acheteur, l’indemnité est limitée au montant du contrat. **LE VENDEUR N’EST SOUMIS A AUCUNE AUTRES OBLIGATIONS OU RESPONSABILITES, DECOULANT D’UNE VIOLATION DU CONTRAT, DE GARANTIES, DE TORTS (INCLUANT LES NEGLIGENCES OU LES RESPONSABILITES STRICTES) OU DANS LE CADRE D’AUTRES THEORIES LEGALES, RELATIVES AUX PRODUITS ET AUX SERVICES VENDUS PAR LE VENDEUR, OU TOUT AUTRE ENGAGEMENT OU OMISSION RELATIF EN CELA.**

Sans limiter la portée de ce qui précède, le vendeur décline expressément toute responsabilité pour les dommages matériels, les pénalités, les dommages spéciaux ou punitifs, les dommages pour la perte de profits ou de revenus, les pertes de temps, la perte de survaleur, le coût du capital, le coût de produits de substitution, ou pour tout autre perte d’un avantage économique ou pour les réclamations des clients de l’acheteur ou tout autre tiers pour de tels dommages, coûts ou pertes.

**LE VENDEUR NE SERA PAS RESPONSABLE ET REJETTE TOUS LES DOMMAGES CONSÉCUTIFS, ACCESSOIRES, INDIRECTS ET ÉVENTUELS.**

L’acheteur devra indemniser et décharger le Vendeur pour et contre toute sorte de perte, d’en-cours, de dommages et intérêts, et de dépenses (notamment, mais sans s’y limiter les honoraires engagés par le Vendeur pour sa défense et les autres coûts liés à sa défense) que le Vendeur peut encourir à la suite d’une réclamation de l’acheteur ou d’un client de l’acheteur ou d’un tiers découlant ou en relation avec les produits ou les services vendus selon les modalités des présentes, à moins que ces pertes, en-cours, dommages et intérêts ou dépenses ne soient finalement attribué uniquement à la seule faute intentionnelle du Vendeur.

## 10. PRIX

Les prix de ventes sont ceux détaillés dans nos tarifs, faisant référence à la marchandise de notre entrepôt de Santa Coloma de Farners avec des emballages en carton non consignés.

## 11. PHOTOS, DONNÉES ET DIMENSIONS

Les photos, **données et dimensions présentes dans le catalogue du Vendeur sont susceptibles d’être modifiées,** sans notification préalable, en raison d’exigences techniques ou de production.

## 12. PROTECTION DES DONNÉES PERSONNELLES

Conformément à ce qu’établit la réglementation en vigueur en matière de protection de données à caractère personnel, VOLLRATH PUJADAS, S.A.U informe l’acheteur que les données personnelles collectées durant la relation commerciale seront traitées et stockées dans les fichiers du vendeur dans le but de pouvoir offrir les services requis ainsi que pour le tenir informé de nouveaux produits et services. Les données fournies seront conservées tant que durera la relation commerciale et, une fois celle-ci terminée, seules seront conservées celles exigées par la législation fiscale. À tout moment, vous pourrez exercer les droits d’accès, rectification ou suppression, limitation de traitement, portabilité et opposition moyennant demande par écrit adressée à info@pujadas.es, accompagnée d’une photocopie de votre numéro de pièce d’identité/ numéro d’identification fiscale. Vous pourrez aussi vous adresser à l’autorité de contrôle compétente pour présenter la réclamation que vous jugerez pertinente.

**Tous les droits de modification sans avis préalable sont réservés, en particulier les couleurs ou les prix des articles figurant dans ce catalogue.**

Photographies non contractuelles.

**CPUJADAS2024**



8 421661 616508

**THE VOLLRATH COMPANY, L.L.C.**

1236 North 18th street  
Sheboygan, WISCONSIN 53081-3201 USA  
Customer Service; 920.459.4851  
Fax. 920.459. 6537  
Credit: 920.459.5387

**VOLLRATH PUJADAS SAU**

Ctra. de Castanyet, 132  
17430 Santa Coloma de Farners  
(GIRONA) - SPAIN  
Tel. +34 972 84 32 01  
info@pujadas.es

**VOLLRATH SHANGHAI TRADING LIMITED**

Room 906, Building A, Hongwell Plaza, No.1308  
Lianhua Road, Minhang District  
Shanghai, 201102 CHINA  
Tel. 86-21-50589580

**VOLLRATH DE MEXICO S. DE R.L. DE C.V.**

Periférico Sur edificio 2-C  
Col. Santa María Tequepexpan  
45601 Tlaquepaque, JALISCO MEXICO  
Tel. (52) 333.133.6767 or (52) 333.133.6769  
Fax. (52) 333.133.6768

**VOLLRATH**

[www.vollrathfoodservice.com](http://www.vollrathfoodservice.com)

©2023 The Vollrath Company, L.L.C.  
An ISO 9001 Certified Company

**STOELTING**  
A VOLLRATH BRAND

[www.stoeltingfoodservice.com](http://www.stoeltingfoodservice.com)

**pujadas**  
A VOLLRATH COMPANY

[www.pujadas.es](http://www.pujadas.es)  
[www.pujadasgrill.com](http://www.pujadasgrill.com)

f @ in ▶

An ISO 9001 Certified Company

